



# Test & Measurement Catalog

---

1991

---

*In this catalog:*

<b>514</b>	ATE
<b>300</b>	Component Measurement
<b>678</b>	Computers & Peripherals
<b>604</b>	Controllers
<b>582</b>	Data Acquisition
<b>558</b>	Datacom Test
<b>84</b>	Digital Multimeters
<b>645</b>	Design Automation
<b>102</b>	Electronic Counters
<b>196</b>	EMC Test
<b>428</b>	Function Generators
<b>322</b>	Lightwave Test
<b>258</b>	Logic Analyzers
<b>706</b>	Measurement Accessories
<b>602</b>	Measurement Systems Architecture
<b>189</b>	Modular Measurement Systems
<b>216</b>	Network Analyzers
<b>344</b>	Noise Figure Measurement
<b>54</b>	Oscilloscopes
<b>204</b>	Phase Noise Test
<b>144</b>	Power Meters
<b>470</b>	Power Supplies/Loads
<b>448</b>	Pulse/Function Generators
<b>514</b>	Semiconductor Test
<b>372</b>	Signal Generators/Synthesizers
<b>152</b>	Signal & Spectrum Analyzers
<b>722</b>	Support
<b>410</b>	Sweep Oscillators
<b>547</b>	Telecom Test
<b>338</b>	Transceiver Test
<b>621</b>	VXI Instruments

*For more information:*

<b>1</b>	Table of Contents
<b>87</b>	Alphabetical Index
<b>192</b>	Numerical Index
<b>2</b>	Customer Information

# Contents

## **1 Introduction**

- 3 MSA-Measurement Systems Architecture
- 6 New Products for 1991
- 25 About Hewlett-Packard
- 27 Alphabetical Index
- 39 Numerical Index

## **2 Electronic Test & Measurement**

- 54 Oscilloscopes, Waveform Analyzers
- 82 Measurement Plotting System
- 84 Digital Multimeters
- 102 Electronic Counters
- 144 Power Meters
- 152 Signal Analyzers
- 216 Network Analyzers
- 258 Logic Analyzers
- 294 Digital Circuit Testers
- 300 Component Measurement
- 322 Lightwave Test Equipment
- 338 Transceiver Test Equipment
- 344 Noise Figure Meters
- 348 Microwave Test Accessories
- 366 Dimensional Measurements
- 370 Pressure & Temperature
- 372 Signal Generators
- 410 Sweep Oscillators
- 424 Amplifiers
- 428 Function Generators & Waveform Synthesizers
- 448 Pulse Generators & Data Generators
- 466 DC Electronic Loads
- 470 Power Supplies
- 506 Frequency & Time Standards

## **3 Board & Semiconductor Test**

- 514 Semiconductor Test Equipment
- 540 Board Test Systems

## **4 Telecommunications & Data Communications Test**

- 547 Telecommunications Test Equipment
- 558 Data Communications Test Equipment

## **5 Controllers, Software, Automated Test**

- 574 Hewlett-Packard Interface Bus
- 582 Data Acquisition Systems
- 602 Computer Aided Test
- 638 Automatic Test
- 640 Technical Computer Systems
- 645 Design Automation

## **6 Accessories, Peripherals, Related Products**

- 666 Solid State Devices
- 668 Analytical Instruments for Chemical Analysis
- 670 Medical Instrumentation
- 672 X-Ray Equipment
- 674 Calculator Products
- 678 Networked Computer Systems
- 682 Personal Computers & Terminals
- 686 Computer Peripherals
- 706 Cables & Adapters
- 708 Transit Cases
- 710 Operating Cases
- 714 Cabinets & Cabinet Accessories

## **7 Ordering Information & Customer Support**

- 722 Customer Support
- 734 Instrument Financing
- 735 Ordering Information
- 736 Operating Environments & Warranty
- 737 Sales & Support Offices
- 748 Application Notes
- 760 Free Publications

1

2

3

4

5

6

7

## Customer Services

### Product & Service Information

#### Customer Information Center

For information about any Hewlett-Packard product or service, or for additional copies of this catalog, call the Customer Information Center (CIC) at 800-752-0900 between 6:00 am and 5:00 pm PST.

#### HP Sales & Support

For local assistance, contact your nearest HP sales and support office. See page 737.

#### HP Publications

For information on other HP publications and other HP catalogs, see page 760.

### Ordering

#### Local Sales & Support Offices

To place an order for any product in this catalog, contact your HP sales representative. See page 737.



#### HP DIRECT

Many products in this catalog can also be ordered for same-day shipment from HP DIRECT (see page 732). To order, call HP DIRECT at 800-538-8787. You can pay by credit card or use an HP DIRECT account. All products have an unconditional 30-day money-back guarantee. There is no charge for surface shipment. To order a free HP DIRECT catalog, use the business reply card that follows page 53, or call HP DIRECT.

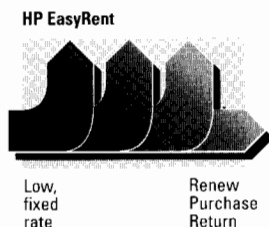

#### Financing

You can "pay as you go" with rental, lease, and finance plans from HP Financing. HP EasyRent offers one of the most cost-efficient avenues for acquiring HP technology in today's marketplace. With HP financing plans, you pay less because HP uses its low cost of funds to minimize your costs. All HP products are eligible. For more information about HP's broad range of plans, see page 734.

### Hardware

#### HP Support Options

The HP Support Options program offers a range of service options that offer low-cost opportunities to extend product warranty benefits for a specified time. See page 723.

### Software

#### HP BasicLine

HP BasicLine offers current, comprehensive support information, with electronic access to information and the right to use HP software updates.

#### HP ResponseLine

HP ResponseLine provides comprehensive software maintenance. It offers all of the features of HP BasicLine, plus unlimited telephone assistance for normal software usage. See page 731.

### Education

#### HP Customer Education

HP has training centers throughout the world. Classes are limited to ten students. Lab equipment is provided at each class, and lab time is assigned. All HP courses can also be scheduled and taught at your site. For a list of courses, see pages 729 and 730. For more information on specific customer education programs, contact your HP sales representative. See page 737.

# Measurement Systems Architecture

Helping you build better measurement systems faster

The test systems of the 90s must be easier to build, provide faster throughput, and last longer. System designers now select system hardware and software components that are proven to work together reliably. Programmers need to reduce the amount of time it takes to write quality application programs. Project managers minimize risks by requiring flexible test systems built from products that meet industry standards. Manufacturers must offer more and better products optimized for test system applications.

High-performance products that meet industry standards are the backbone of HP's Measurement Systems Architecture (MSA). Hewlett-Packard offers a wide array of products that meet industry standards such as IEEE 488.2, SCPI, VXIbus and MMS. More importantly, HP's implementations of these standards have been designed to optimize the performance of your test systems.

HP's MSA approach is illustrated by the diagram to the right, which represents a generic

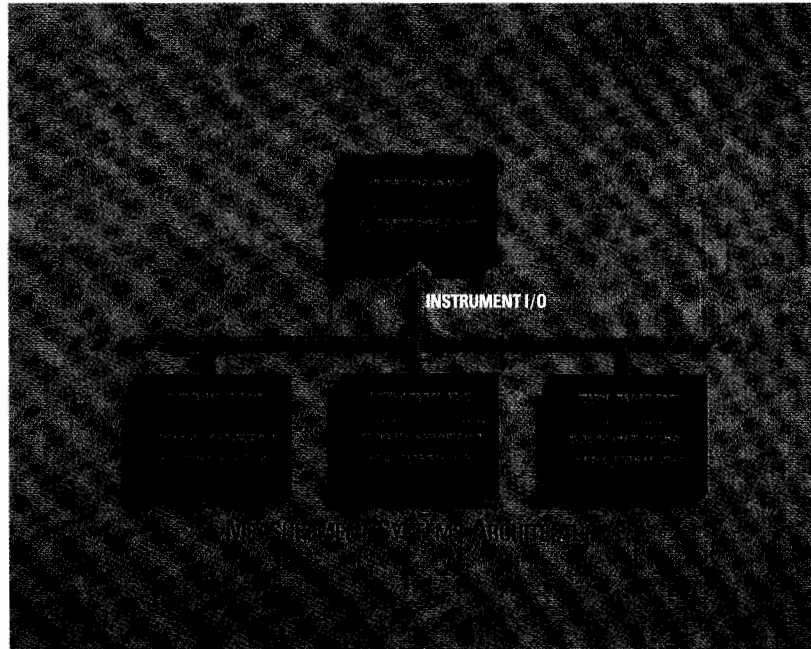

test system. As shown in the table, HP currently offers a spectrum of products that allow you to build high-performance test systems that are compatible with industry standards. In addition, HP continues to develop the products, development tools, and

support you need to build test systems faster and more effectively throughout the 90s.

The following two pages provide an overview of key HP products that constitute the current MSA lineup.

Component	Description	HP solutions	See page
<b>Software</b>	Operating systems	HP BASIC, MS-DOS®, UNIX	604
	Languages	HP BASIC	604
	Software development tools	HP Interactive Test Generator (HP ITG)	610
		HP Functional Test Manager (HP FTM)	612
	Instrument drivers		611
<b>Controllers</b>	Computer platforms	HP 9000 Series 300 Workstations (Motorola based)	605
		PC-300 Controllers (Intel-based)	605
	Form factor	Rackmountable (R/332 controller)	609
		VXI embedded (V/360)	609
<b>Instrument I/O</b>	Data/control highway	HP-IB (IEEE 488.2)	574
		VXIbus	621
		Modular Measurement System (MMS)	189
<b>Instrument Firmware</b>	Drives hardware	SCPI	602
		HP Instrument BASIC	594, 622
<b>Instrument Hardware</b>	Measurement and switching	HP-IB instruments	574
		VXI cards	621
		MMS modules	189
	Hardware development tools	MMS and VXI development tools	603

MS-DOS is a U.S. registered trademark of Microsoft Corporation

UNIX is a registered trademark of AT&T in the U.S.A. and in other countries

## SCPI

SCPI (Standard Commands for Programmable Instruments) is the name of an industry standard adopted by HP and eight other manufacturers in April 1990. SCPI is based on IEEE 488.2 and HP's Test and Measurement Systems Language (TMSL). SCPI is a set of universal commands for instruments that makes it easier and quicker to develop test programs. SCPI's common commands simplify software development because you no longer need to learn a different language for every instrument. HP's TMSL products are already compatible with the SCPI standard, and HP is implementing SCPI in many more products.

## Instruments

HP's MSA includes both modular product families and stand-alone HP-IB instruments, all optimized for automated test systems. The HP 75000 VXI products allow you to integrate a wide range of

switching, analog, and digital measurement capability into mainframes that meet the industry-wide VXIbus standard. The HP 70000 system provides rugged, reliable instruments for demanding mea-

surements from RF to lightwave that meet the industry-wide MMS standard. Many new HP instruments include built-in controllers running IBASIC, a subset of HP BASIC.



*All HP 75000 VXI modules use SCPI, the new industry-wide standard command set, and are supported by HP ITG software, giving you compatibility, ease-of-use, and fast system development.*



*HP's rack-and-stack HP-IB instruments provide a solid foundation for your computer-aided test applications.*

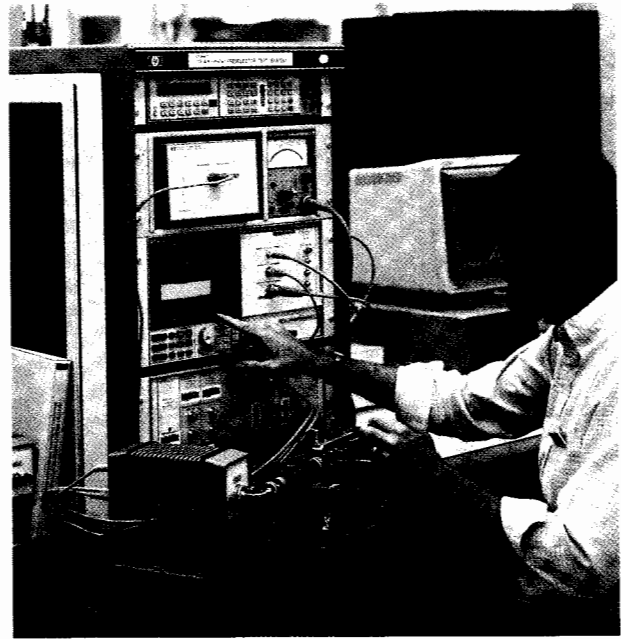

*For applications from RF through lightwave, the HP 70000 modular measurement system (MMS) provides rugged and reliable high-performance instrumentation.*

## Measurement Systems Architecture (cont'd)

### Controllers

HP's MSA provides the widest range of controllers in the test and measurement industry, including HP Series 300 and PC controller solutions. HP provides desktop and rackmount controllers for system applications and embedded controllers for HP VXI system. HP's instrument controllers support industry-standard operating systems such as MS-DOS® and HP-UX, as well as the premiere test environment of HP BASIC. HP's controllers can easily exchange data with other computers through HP's networking hardware and software.

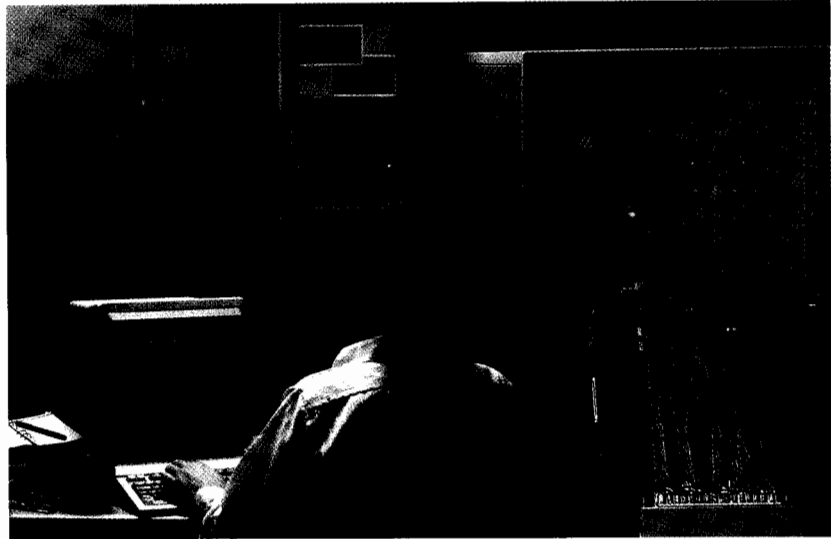

*From PCs to workstations, HP's family of instrument controllers provides the performance you need plus a choice of hardware platforms, operating systems, and form factors.*

### Software

HP's MSA includes software products designed to reduce your test development time. HP BASIC is an easy-to-use and highly productive programming language for developing and executing application software. HP's Interactive Test Generator (HP ITG) is a software development tool that controls instrumentation and generates instrument control code automatically. HP's Functional Test Manager (HP FTM) provides a versatile, reusable framework for functional tests.

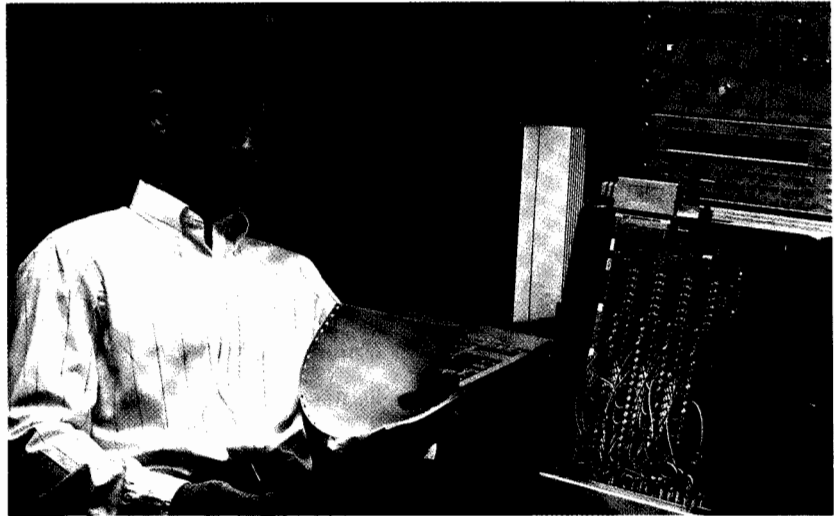

*HP's CAT software solutions range from general-purpose tools such as HP ITG to application specific packages such as HP FTM.*

### Support Services

MSA includes a variety of support services to help get test systems up and running quickly. With over 600 support engineers worldwide, HP can provide the technical support you need when and where you need it. In addition, HP provides system design and consultation for custom applications.

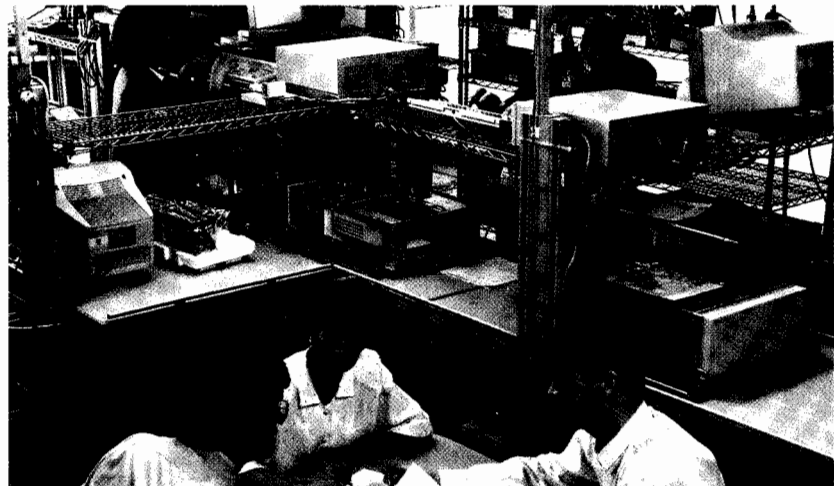

*HP's consulting services are designed to help you quickly advance from installation to optimal system use, whether you need a few hours of guidance or a complete custom plan.*

## VXI System Products

### HP E1426A 500 MHz VXI Digitizing Oscilloscope

The HP E1426A digitizing oscilloscope is a 2-slot C-size VXI module that provides 4 channels with 500 MHz repetitive bandwidth. For single-shot capture, it also provides simultaneous capture

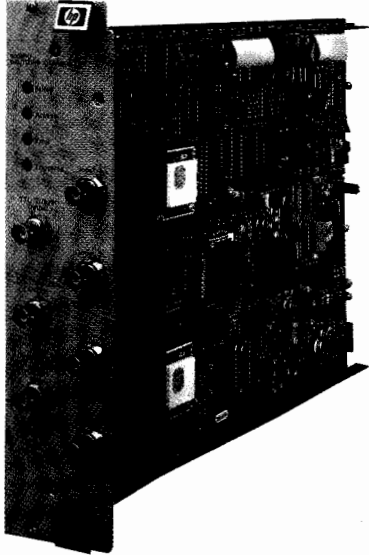

on 2 channels at up to 20 megasamples per second. The VXI module maintains the accuracy and powerful triggering of the HP 54503A digitizing oscilloscope.

The HP E1426A contains two command sets: (1) the HP 54503-based command set, which maintains a high degree of compatibility with commands for the HP 54503A digitizing oscilloscope; (2) the SCPI command set, which simplifies learning to program SCPI instruments.

The VXI oscilloscope can also be programmed with HP ITG test generation software.

Specifications — see page 625  
Product literature — check 1 on New Products Reply Card

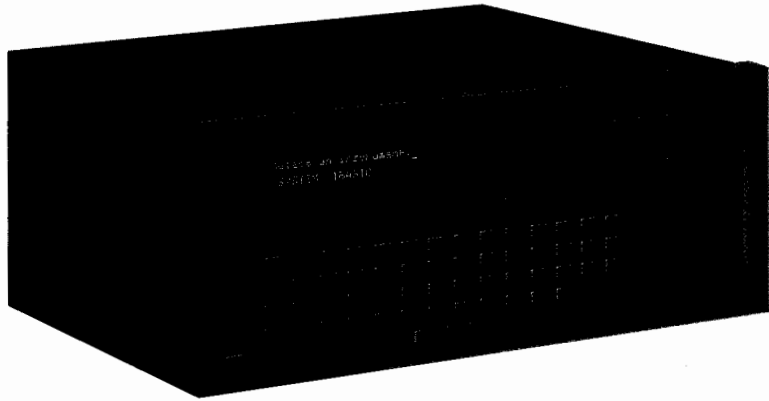

### HP E1300A, HP E1301A Remote Acquisition Family

These instruments are used for remote monitoring applications in which the data acquisition instruments must be physically separated from the computer. They work reliably and accurately to simplify unattended characterization of products and processes. For long distances, link them to the computer using modems or hard-wired RS-232C/422 cables. A built-in

IBASIC controller can be added for standalone capabilities. External dc power operation provides a bumpless transfer between ac and dc power, ensuring an uninterrupted power supply if ac power is lost.

Specifications — see page 629  
Product literature — check 1 on New Products Reply Card

### HP E1420A Universal Counter

Designed to quickly provide your VXI system with time and frequency information, the

HP E1420A is HP's first message-based, C-size VXI universal counter. With 3 to 10 times the speed of rack and stack counters, the HP E1420A can greatly decrease system test times.

Auto triggering allows automatic rise time, fall time, and pulse-width measurements. You can also measure ac, dc and peak-to-peak voltages. All these measurements are programmable via the industry standard SCPI language.

The HP E1420A features a 200 MHz frequency range, 2 ns time interval resolution (200 ps with averaging) and 9 digit/s resolution. The optional TCXO time base improves the accuracy of the VXIbus system clock and the HP E1420A measurements without using a VXI slot. A 3-year warranty assures you of the lowest possible cost of ownership.

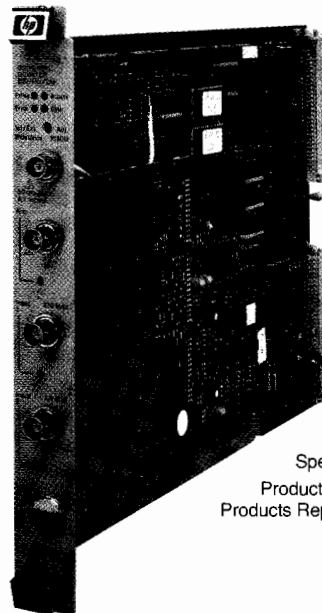

Specifications — see page 624  
Product literature — check 1 on New Products Reply Card



Hewlett-Packard Company develops, manufactures and markets measurement and computation products and systems for people in science, engineering, business, industry, education, and medicine. Over 10,000 HP products are known for high quality, reliability, and advanced technology.

### Hewlett-Packard in Profile

Headquartered in Palo Alto, California, HP employs 92,000 people worldwide. The worldwide sales organization includes offices in 140 cities in the USA, and there are over 300 sales and support offices and distributors in 92 other countries.

HP is ranked in the top 50 US industrial corporations, and it is one of the top 15 US exporters. Approximately half the revenue is generated outside the United States, with European sales accounting for more than half of international sales. Other principal markets include Japan, Canada, Australasia, the Far East, and Latin America.

### Founded in 1939

Bill Hewlett and Dave Packard founded Hewlett-Packard Company in 1939. The company has focused on developing high-quality, innovative electronic instruments for broad applications. Today, HP is the world's leading manufacturer of electronic test and measuring instruments.

### HP Innovation

Each year HP invests about ten percent of its net revenue in R&D. This heavy investment enables HP to remain a leader in technological development and to maintain a steady flow of new and useful products.

HP allocates about 85 percent of the company's annual R&D budget to product development within 50 divisions. The remaining 15 percent is invested in more basic, higher-risk, longer-term research by HP Laboratories, one of the leading scientific and technical research centers in the world.

HP believes that, in the future, there will be increasing emphasis on systems that take advantage of computer and instrument capabilities and standard interfaces. Digital architectures are changing the way analog measurements are made.

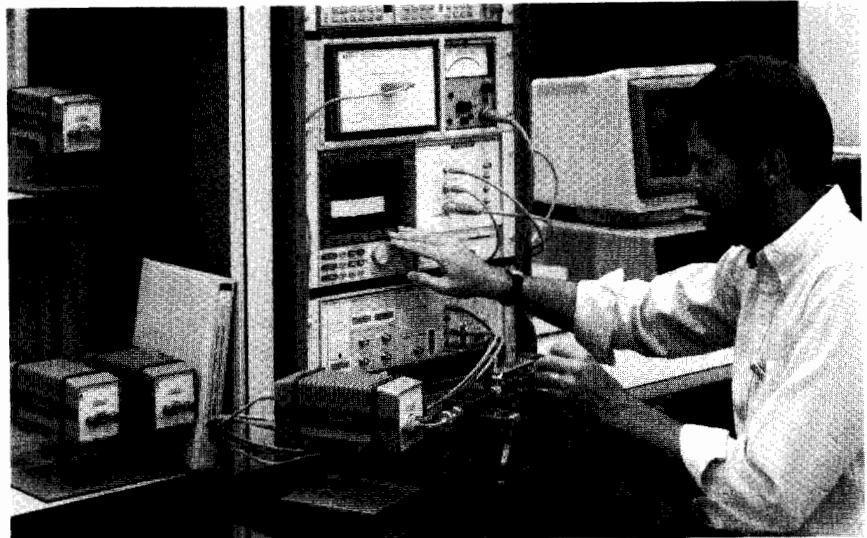

HP's industry-standard modular equipment makes measurements at millimeter-wave frequencies.

### Wide Range of Products

HP products serve the electronics, telecommunications, aerospace, aircraft, and automotive industries, as well as scientific research programs.

HP also manufactures other products related to electronics technology. These related products include solid-state components, primarily microwave, semiconductor, and optoelectronic devices.

HP's rugged and versatile calculators have made the engineer's slide rule obsolete.

Also, HP has extended electronics technology to the fields of medicine and analytical chemistry. Instruments often incorporate computer technology to provide additional automation and precision not available in competitive products.

HP computers were originally designed to gather and analyze data from instruments. Today, computers, computer systems, peripheral devices, and calculators constitute a major portion of the company's products.

### HP Test and Measurement Systems

Customers use HP instruments in evaluating the performance of their own equipment, in developing new products, in controlling quality and manufacturing processes, and in field service applications. HP instruments are used in almost every industry that requires precise testing, measurement, and control.

HP instruments and computers are designed with systems in mind. HP combines precision electronic equipment into interactive systems that provide total solutions to information needs. These integrated systems allow customers to access essential information, put it in meaningful form, and improve their effectiveness.

### A Leader in Open Industry Standards

HP has taken a leading role in helping to establish fully open, modular standards that any manufacturer can build on. HP's internal standard for linking HP instruments and computers has become a worldwide standard, IEEE 488-1978. We call this standard HP-IB, the Hewlett-Packard Interface Bus.

HP has built on the HP-IB standard to create the new Measurement Systems Architecture (MSA), an integrated approach to automatic testing. MSA will continue to evolve to keep pace with the changing measurement needs of automated testing. MSA is described in more detail on page 562.

MSA uses SCPI (standard commands for programmable instruments), which is based on IEEE 488.2 and HP's test and measurement systems language (TMSL). By providing a single set of commands for all types of instruments, SCPI simplifies software development and increases the compatibility of software generations as hardware is upgraded.

# ABOUT HEWLETT-PACKARD

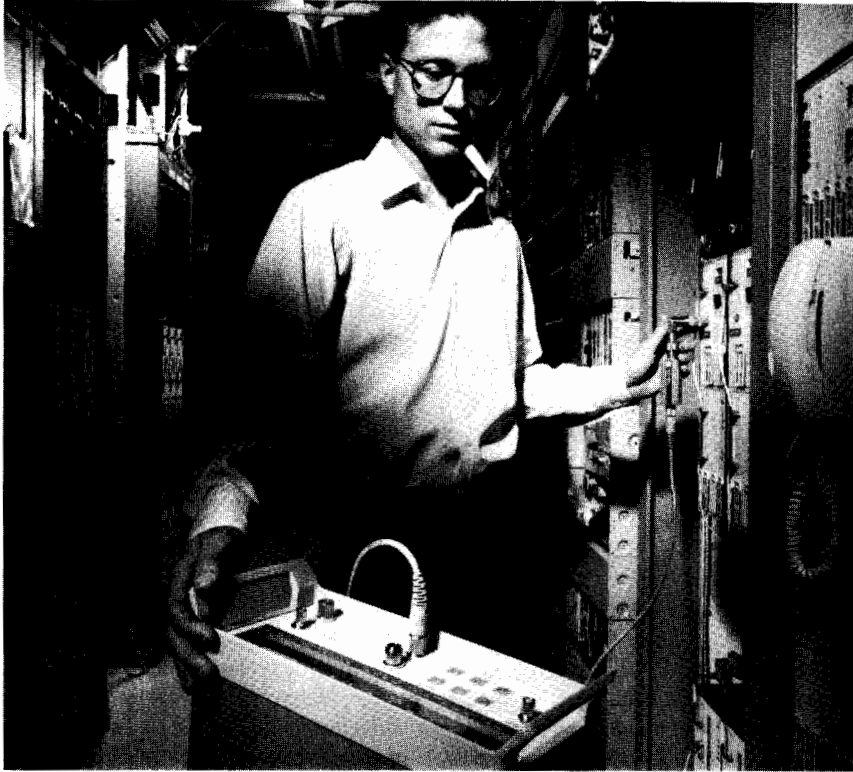

Field microwave frequency and power measurements are made quickly and conveniently with the HP 5347A/5348A counter/power meter.

## HP Computers

HP's strength in engineering, scientific, and manufacturing applications has enabled it to make major contributions in key technical computer markets. Advanced data communications technology allows instrument systems to be linked with computers, giving customers tools for acquiring, analyzing, managing, and transmitting data. Powerful desktop workstations from HP improve the productivity of engineers working on complex tasks.

HP also is an important manufacturer of business computers, portable computers, personal computers, and mini-computers.

HP also introduced a series of high-performance computers based on HP Precision Architecture.

## HP Product Standards

All HP products must meet HP's design and test standards for a range of typical operating environments. These standards are derived from our experience with environmental conditions at customer installations and from industry standards such as IEC, ISO, ANSI, and MIL.

The classification codes used to identify expected environments range

from controlled to severe, as described on page 736. Most HP hardware products are designed to meet Class B2, general-purpose applications in light industrial and commercial facilities.

## HP Support

HP's commitment to engineering excellence is equaled by its commitment to providing customers with high-quality support services. HP's support organization consists of a worldwide sales and service network staffed by highly trained engineers and technicians. Our support starts before you purchase an HP product and continues long after the product is delivered.

HP also offers a full range of instrument rental and lease plans. See page 734.

HP's worldwide support network ensures prompt availability of replacement parts throughout the service life of products and beyond.

For products requiring consumable supplies, such as recording paper, ribbons, and magnetic media, we offer fast, convenient service from well-stocked supply centers.

HP's comprehensive support extends to information services, including

excellent hardware and software manuals, and a variety of free publications. These publications help you choose the HP products that best fill your needs, allow you to benefit from the applications knowledge of users inside and outside of HP, and help you maintain your HP products. For information about these publications, see page 760.

## Contacting Hewlett-Packard

For locations of HP sales and service offices, see page 737. Calls to your local HP office are routed to the person best qualified to help you.

You can also contact HP through toll-free phone numbers at a growing number of Customer Information Centers (CICs) worldwide. In addition, CICs can arrange for you to receive free publications. The listing of HP offices (page 737) includes CIC locations and phone numbers.

## Suggestions Welcomed

The purpose of this catalog is to give you useful information about HP products in order to help you reach decisions on products and systems that will meet your needs. To obtain HP product literature, contact your local sales office.



HP 3070 board test systems locate faults and faulty components on PC boards.

If you have any comments and suggestions about how we can make this catalog more useful to you, please let us know by writing to us at the following address:

Hewlett-Packard Company  
Stu Center  
T&M Catalog Manager  
5301 Stevens Creek Boulevard -  
MS 54 AF  
P O Box 58059  
Santa Clara, CA 95052-8059  
USA

- A**
- A/D Converters ..... 54, 78-82, 637
- AC
- Power Source ..... 178
- Probes ..... 99
- True RMS Voltmeters ..... 98
- Voltmeters ..... 84-99
- AM/FM Signal Generators ..... 374-378, 380-383, 385-391, 394, 396-399, 406-408
- AM/FM Test Source ..... 210
- AM/FM/ $\phi$ M Modulation Analyzers ..... 106-111, 209
- AM/FM/ $\phi$ M Signal Generators ..... 380-383, 385-391, 398-399, 404-405
- APC Adapters ..... 707
- ASIC Test System ..... 515-517
- Accessories
- Adapters ..... 706-707
- Board Test Systems ..... 546
- Cabinet ..... 721
- Cables/Connectors ..... 223, 243, 579, 706-707
- Cases ..... 713
- Catalogs ..... 732, 760
- Component Measurement ..... 301
- Computer ..... 732
- Connectors ..... 706-707
- Digital Multimeter ..... 99
- Fixtures ..... 546
- Lightwave ..... 313
- Network Analyzer ..... 216, 221-224, 232, 241, 243-244, 247, 295
- Operating Cases ..... 708
- Oscilloscope ..... 72-76
- Signal Generator ..... 409
- Spectrum Analyzer ..... 188, 198, 235
- Transit Cases ..... 709, 711
- Voltmeter ..... 99
- Waveguide ..... 252, 359, 363-365
- Acoustic Test ..... 165, 166
- Active Probes ..... 72, 235, 297
- Adapters
- 50-75 $\Omega$  ..... 244
- 50-75 $\Omega$  ..... 409, 706
- APC-3.5, APC-7 ..... 707
- Bends, Twists, Waveguide, Coaxial ..... 365
- Quasi-Peak ..... 198
- Agile Signal Generator ..... 398, 402-403
- Agile Signal Simulator, Up-Converter ..... 402-403
- Air Line Extensions ..... 350
- Alphanumeric LED Displays ..... 666
- Amino Acid Analyzer ..... 668
- Ammeters ..... 84-99, 532
- Amplified Lightwave Converter ..... 336
- Amplifiers
- Broadband Power ..... 424
- Distribution ..... 512
- Microwave ..... 188, 426
- Power Supply ..... 503
- RF ..... 424-425
- Analog
- Circuit Test Systems ..... 540, 542-545
- Converters, A-D ..... 54, 78-82, 637
- LSI Test System ..... 519
- Voltmeter ..... 98
- Analytical Instruments ..... 668
- Analyzer, Amino Acid ..... 668
- Analyzers
- Accessories ..... 280
- Attenuator Calibration ..... 213
- Audio Spectrum ..... 156-165, 167-168, 202, 232
- Audio ..... 153-155, 202, 207
- Automatic Network ..... 229, 248
- Automatic Spectrum ..... 173-193, 196-202, 232
- Constellation ..... 556
- Customer Support ..... 727
- Data Line ..... 553
- Digital Microwave Radio ..... 556
- Digital Radio ..... 173-174, 179-180
- Digital Transmission ..... 206, 548-549, 551, 556
- Distortion ..... 153, 155, 203, 207-209, 211-212
- Dynamic Signal ..... 154
- EMC ..... 173-174
- Error Performance ..... 548, 552
- Fourier (FFT) ..... 153, 157-165, 167-168
- Frequency Stability ..... 106-111, 204
- Frequency and Time Domain ..... 78-79, 106, 157-165, 167-168, 202
- Gain-Phase ..... 229, 231, 302
- Impedance/Gain-Phase ..... 302, 304
- Impedance ..... 234, 300-304, 306-307
- Jitter ..... 106, 548, 551
- LAN Protocol ..... 564
- Logic ..... 57, 258-259, 270, 272, 276-278, 291-292
- MAP Protocol ..... 560-561
- Microwave Modulation ..... 106, 109-111, 206, 215, 556
- Microwave ..... 173-175, 178-180, 189, 193, 215
- Millimeter Wave ..... 179-180
- Modulation ..... 106, 154-155, 206, 209
- Network ..... 156-164, 216-228, 236
- Phase Noise ..... 106, 155, 204
- Phase ..... 106, 206
- Primary Multiplex ..... 553
- Protocol ..... 558-561, 564
- Pulsed Phase ..... 206
- RF Impedance ..... 306
- RF Signal Modulation ..... 206, 209, 215
- RF ..... 177-180, 189, 193, 215
- Scalar Network ..... 219-228
- Selective Level ..... 202, 554
- Semiconductor Parameter ..... 526
- Signal Generator Test ..... 214
- Signature ..... 294-296
- Spectrum ..... 152-153, 155, 173-193, 196-202
- Time and Frequency Domain ..... 106, 157-165, 167-168, 202
- Timing/State/Performance ..... 648-653
- Training ..... 727
- Vector Modulation ..... 206
- Vibration ..... 157
- WAN Protocol Analyzer ..... 560-561
- Wave ..... 202, 447, 554
- Waveform ..... 54, 64, 78-82, 157, 161-165, 167-168, 189-193, 206
- Antenna Measurements ..... 255
- Apple/Macintosh Print Connections ..... 677
- Application Notes ..... 760
- Arbitrary Waveform Generators ..... 80, 400, 430, 434-436, 438, 464
- Arbitrary Waveform Synthesizer ..... 400
- Architecture, Measurement Systems ..... 603
- Atomic Clock/Frequency Standard ..... 506
- Atomic Emission Detectors ..... 669
- Attenuating Lens Adapter ..... 331
- Attenuator/Switch Driver ..... 355
- Attenuators
- Calibration ..... 213
- Coaxial ..... 350-354
- Step, Programmable ..... 352
- Test System ..... 213
- Waveguide, Fixed, Variable ..... 364

## ALPHABETICAL INDEX

Audio Synthesizer ..... 434-436, 443-444, 447, 554  
 Autochangers ..... 686  
 Automatic Test Systems ..... 638

**B**

BASIC, HP BASIC Systems ..... 604-605  
 BER Test Sets ..... 552, 547  
 BNC Series Adapters ..... 706  
 Balanced 2/4 Wire Audio Channel Selector ..... 553  
 Bar Code  
 Identification Systems ..... 669  
 Printers ..... 691  
 Readers ..... 667  
 Wand ..... 667  
 Bar Graph Array, LED ..... 666  
 Battery Operated  
 Counters ..... 130, 140-142  
 DMM ..... 86-98  
 Microwave Power Meter ..... 147  
 Portable AC Power Source ..... 178  
 Printers ..... 690  
 Standby Power Supplies ..... 513  
 Beam Lead Diodes ..... 667  
 Bias Current Source ..... 311  
 Bias Networks ..... 251  
 Bipolar Transistors ..... 667  
 Bit Error Rate Test Sets ..... 548, 551-553  
 Board Test Fixtures ..... 546  
 Board Test/Semiconductor Test, Training ..... 728  
 Board Testers ..... 540-545  
 Breadboard Cards, Multiprogrammer ..... 637  
 Bridges, Directional ..... 221-222, 349  
 Broadband Amplifiers ..... 425-427  
 Business Computer Systems ..... 683

**C**

C Meters ..... 314, 316-318, 534  
 C-V Meter ..... 317  
 C-V Plotter ..... 534  
 CAD Software ..... 645-647, 657-659, 661-665  
 CAE Links ..... 279  
 CAE Software ..... 538  
 CASE, CASEdge ..... 654  
 CATV Analyzers ..... 173  
 Cabinet Accessories ..... 714, 716  
 Cabinets, Rack ..... 720-721  
 Cable Assemblies ..... 223, 243, 707  
 Cable Kit, Scalar Analyzer ..... 223  
 Cables/Connectors ..... 707  
 Cables  
 HP-IB ..... 579  
 Network Analyzer ..... 223, 239-240, 253  
 Calculators-Enhancements, Peripherals & Software ... 677, 689, 694  
 Calculators ..... 674-677  
 Calibration Data, Attenuators ..... 350-351  
 Calibration Kits (Network Analyzer) ..... 223, 243, 252  
 Calibration Service ..... 723  
 Calibration System, Attenuator ..... 213  
 Calibrators  
 AM/FM (HP 8901A/B) ..... 209  
 Power Meter, for HP 432 Series ..... 150  
 Range, for HP 435B Power Meter ..... 147  
 Scalar, for HP 8756A & 8757A ..... 224

Capacitance Meters ..... 314, 316-318, 534  
 Capacitor Sets ..... 321  
 Capacitor, Blocking ..... 350  
 Cardiology and Cardiovascular Instrumentation ..... 670  
 Carrier Modulation Analyzers ..... 206  
 Cases ..... 718-719  
 Catalog  
 Computer Users Supplies and Accessories ..... 732  
 DC Power Supply ..... 760  
 Instruments Now ..... 732  
 Summary ..... 760  
 Cavity Frequency Meters ..... 363  
 Cellular Radio Test and Measurement ..... 338, 341, 343  
 Centronics ..... 695  
 Cesium Beam Frequency Standard ..... 508  
 ChemStations ..... 668  
 Chromatography ..... 668, 669  
 Circuit Modeling ..... 536-537  
 Circuit Test Systems ..... 540-541, 541-546  
 Circuit Testers, Digital ..... 294-299, 540-546  
 Circuit Testers, SMT ..... 542-543  
 Circuit/Device Modeling ..... 515  
 Clinical Information Systems ..... 671  
 Clip, Logic ..... 298  
 Clock, Atomic ..... 508  
 Clock, Digital ..... 580  
 Coaxial  
 Accessories ..... 349-353, 355-359, 361, 361-364, 707  
 Adapters ..... 365  
 Air Lines ..... 361  
 Attenuators ..... 350-354, 364  
 Blocking Capacitor ..... 361  
 Connector Gages ..... 361  
 Couplers ..... 362, 363  
 Detectors ..... 358, 359  
 Frequency Meters ..... 363  
 Low-Pass Filters ..... 364  
 Matrix Switches ..... 355-357  
 Noise Sources ..... 347  
 Open-Short Circuits ..... 361  
 Pad Attenuators ..... 350-351  
 Power Sensors ..... 148, 151  
 Programmable Step Attenuators ..... 354  
 Shorts ..... 361  
 Sliding Loads ..... 361  
 Switches ..... 355-357, 615  
 Terminations ..... 361  
 Thermistor Mounts ..... 151  
 Thermocouple Mounts ..... 148  
 Waveguide Adapters ..... 365  
 Combining Cases ..... 718-719  
 Command Module ..... 629  
 Communications Test Equipment ..... 202, 206, 338, 404-405,  
 434-436, 540-545, 547-556, 558-561, 564, 567, 570-573  
 Communications, Data ..... 106, 558-561, 564, 567, 571-573  
 Communications, Signaling ..... 434-436, 443-444, 447  
 Comparator, Logic ..... 298  
 Comparator, Phase ..... 231, 511  
 Compliance Test Systems ..... 196-197, 199-201  
 Component & Semiconductor Measurement  
 Digital IC Test System ..... 516-517, 526  
 Impedance, LCR Meters ... 300-304, 306-310, 312, 314, 316-318  
 Semiconductor Parametric Test ..... 520-524, 526, 528, 530-532  
 Components, Solid State ..... 666-667  
 Computer-Aided Design (CAD), Computer-Aided Engineering  
 (CAE) ..... 538, 645-647, 657-659, 661-665, 687, 694-699  
 Computer-Aided Software Engineering (CASE) ..... 645, 648-653

Computer-Aided Test  
 Controllers ..... 604-606, 609  
 HP-IB Interface and Command Library ..... 606  
 Interfacing ..... 614  
 Measurement Systems Architecture ..... 602  
 Systems ..... 614  
 Computers and Peripherals  
 Autochangers ..... 686  
 Automatic Test Systems ..... 540-545, 638  
 Board Computers ..... 642-643  
 Computer Users Catalog ..... 732  
 Digital Audio Tape ..... 686  
 Digitizing Tablets ..... 688  
 Graphics ..... 681, 684, 690-692, 694-699  
 HP Measurement Coprocessor ..... 606  
 Instrument Controllers ..... 604-606, 609  
 Library system ..... 686  
 Monitors ..... 684  
 Networked Computer Systems ..... 678-679, 681  
 Optical storage ..... 686  
 Personal Computers ..... 682, 684-685  
 Plotters ..... 694-699  
 Printers ..... 690-692  
 Real-Time Systems ..... 642-643  
 SCSI Interface ..... 642  
 Secondary Storage ..... 686  
 Supplies and Accessories ..... 693, 732  
 Support ..... 722  
 Tape Storage ..... 686  
 Technical Computers ..... 642-644  
 Terminals ..... 685  
 X-Window Software ..... 644  
 Connector Gage ..... 350, 361  
 Connectors ..... 707  
 Constellation Analyzer ..... 556  
 Consulting Services ..... 731  
 Controllers  
 Bundles ..... 608  
 HP BASIC Controllers ..... 604-606  
 HP-IB Interface and Command Library ..... 606  
 HP-UX Controllers ..... 604  
 Multiprogrammers ..... 632-633  
 PC Controllers ..... 606-607, 633  
 Rackmountable ..... 609  
 VXI ..... 609, 629  
 Converter, Frequency ..... 255  
 Converters  
 A-to-D ..... 54, 78-82, 637  
 D-to-A ..... 580, 598, 637  
 Counter/Power Meter ..... 118, 147  
 Counters, Electronic  
 Counter/Analyzer ..... 106  
 Counter/Timers ..... 112, 132-138, 140-143  
 Counter/Totalizers ..... 594-595, 624, 637  
 DVM/DMMs ..... 136-139  
 Digital Multimeter/Counters ..... 295, 583, 598, 637  
 Frequency ..... 112, 130, 134, 136, 139-140, 143  
 Low Cost ..... 107-114, 130-131, 134-135, 140-143  
 Microwave ..... 106, 115-117, 120-131  
 Multiprogrammer Card ..... 637  
 Portable, Battery Operated ..... 130, 140-143  
 Pulsed RF ..... 106, 124-127  
 Reciprocal ..... 115-117, 120-138, 140-142, 583, 598  
 Time Interval ..... 106-113, 132-143  
 Universal ..... 112, 132-143, 624  
 VXI ..... 624  
 Couplers, Directional (Coax and Waveguide) ..... 362-363

Crystal Detectors ..... 358-359  
 Crystal Oscillator ..... 510  
 Current Tracer, Digital ..... 297  
 Custom MW Matrixes ..... 355  
 Customer Education ..... 722  
 Customer Support ..... 722-728, 731

**D**

D/A Converters ..... 580, 594-595, 598, 625, 637  
 DAT ..... 686  
 DC Power Supplies  
 Amplifier/Power Supply ..... 503  
 Autoranging ..... 486, 490, 494  
 Calibration Software ..... 489  
 Condensed Listing ..... 500-504  
 Constant-Current Sources ..... 505  
 Dual Tracking ..... 492, 500  
 General Information ..... 470  
 General Purpose: 10-30 W Output ..... 500  
 General Purpose: 25-200 W Output ..... 492  
 HP-IB Programmable ..... 472, 477-487, 490-491  
 Output Isolation Relays ..... 488  
 Polarity Reversal Relays ..... 488  
 Precision Voltage Sources ..... 504  
 Programmable ..... 470-475, 477-487, 490-491  
 Source/Monitors ..... 484, 528, 531  
 Specifications, Definitions ..... 476  
 DC Voltmeters ..... 84-99, 136-139, 583, 586-591, 598-599  
 DDS format tape drive HP-IB ..... 686  
 DDS format tape drive SCSI ..... 686  
 DN4500 ..... 654, 654  
 DS3 Transmission Test Set ..... 551  
 Data Acquisition  
 Manager ..... 601  
 Measurement and Control Unit ..... 582  
 Software ..... 600  
 System Training ..... 727  
 Systems ..... 82, 582-583, 583, 585-591, 596-600  
 VXI System ..... 594-595  
 Voltmeters/Counters ..... 84-99, 132-142, 582-583, 583, 586-591, 596-599  
 Data Communications Test Equipment  
 Conformance Testers ..... 563  
 Datacom Test Sets ..... 573  
 Digital Data Test Sets ..... 570  
 General Information ..... 558, 570  
 LAN Protocol Analyzer ..... 564  
 MAP Protocol Analyzer ..... 560-561  
 Network Testers ..... 563  
 Protocol Analyzers ..... 558-564  
 Selective Level Meter ..... 202, 554  
 Spectrum Analyzers ..... 152  
 Time Interval Analyzer ..... 106  
 Transmission Impairment Measuring Sets ..... 571-572  
 Transmission Impairment Test Sets ..... 570  
 Vector Modulation Generator/Analyzer ..... 556  
 WAN Protocol Analyzer ..... 560-561  
 ISDN Protocol Analyzer ..... 560-561  
 X.25 Protocol Analyzer ..... 560-561  
 Data  
 Acquisition Systems ..... 82, 583, 583, 586-591, 596-599  
 Communications Test Equipment ..... 558  
 Communications ..... 106, 559-564, 571-573  
 Generators ..... 438, 462-463, 552  
 Pulse Pattern Generator ..... 463

## ALPHABETICAL INDEX

- Time Interval Analyzer ..... 106  
 Datacom Test Sets ..... 573  
 Decade Capacitor ..... 321  
 Degaussers ..... 511  
 Delay Generators ..... 448-452, 454-458, 460-461  
 Design Automation ..... 645-647, 657-659  
 Design Systems, Training ..... 728  
 DesignCenter Products ..... 645, 647, 657-659, 661-663  
 Desktop Plotters ..... 695  
 Detectors  
 Adapter ..... 225  
 Coaxial, Microwave, OEM ..... 358  
 Crystal, Coaxial and Waveguide ..... 358-359  
 Error ..... 548  
 For Chemical Analysis ..... 668  
 Scalar ..... 221-222  
 Development systems, logic ..... 648-653  
 Device Modeling ..... 536-537, 538  
 Diagnostic Cardiology ..... 670  
 Dielectric Measurement Systems, Probes ..... 254  
 Digital Audio Tape ..... 686  
 Digital Cellular ..... 342-343, 376-377  
 Digital Data Storage ..... 686  
 Digital Data Test Equipment ..... 547, 550, 570  
 Digital Microwave Radio Test ..... 555  
 Digital Radio Analyzers ..... 173  
 Digital Radio Measurement Personalities ..... 179  
 Digital Radio Test System ..... 557  
 Digital Transmission Test Equipment ..... 547  
 Digital  
 AC Voltmeters ..... 84-99  
 Ammeter ..... 532  
 Analyzers, Signature ..... 294-296  
 Audio Synthesizer ..... 434-436  
 Bar Code Wand ..... 667  
 Board Testers ..... 540-546  
 Capacitance Meters ..... 314, 316-318, 534  
 Circuit Test ..... 294-299, 540-546  
 Combinational Board Tester ..... 540-545  
 Communications Board Tester ..... 540-541, 544-545  
 Constellation Analyzer ..... 556  
 Current Tracer ..... 297  
 D/A Current Converter Cards ..... 598, 637  
 D/A Voltage Converter Cards ..... 598, 637  
 DC Voltmeter/Counters ..... 136-139  
 DC Voltmeters ..... 84-99, 583, 586-591, 598-599  
 High-speed Test ..... 552  
 IC Testers ..... 294-298, 515, 518-519, 532, 540-546  
 Impedance Analyzers ..... 300-304, 306-307  
 In-Circuit Board Test Systems ..... 540-546  
 Input Cards, Multiprogrammer ..... 637  
 Input/Output ..... 594-595  
 LCR Meters ..... 308-310, 312, 314, 316-317  
 Microprocessor Troubleshooting ..... 294-296  
 Modulation Analyzer ..... 206  
 Modulation Signal Generator ..... 404-405  
 Multimeters, Multiprogrammer ..... 636  
 Multimeters, Signature ..... 294  
 Multimeters ..... 84-99, 623  
 Noise Figure Meter ..... 345  
 Oscilloscopes ..... 55-67, 78-79, 276  
 PC Board Test Systems ..... 540-546  
 Power Meters ..... 144-146  
 Pressure Gauge ..... 370  
 Programmable Power Supplies ..... 470-475, 477-487, 490-491  
 Q Meter ..... 308-309  
 Signal Analyzers ..... 206  
 Signal Generators ..... 278, 404-405  
 Signature Analyzers ..... 294-296  
 Stimuli ..... 448-452, 454-458, 460-465  
 Thermometers ..... 583, 598  
 Time Interval Analyzer ..... 106  
 Transmission Analyzer ..... 548-549, 551  
 Troubleshooting ..... 294-299  
 Voltmeters ..... 84-99  
 Digitizer, MMS Module ..... 189-193  
 Digitizing Oscilloscopes ..... 54-67, 78-79  
 Digitizing Tablets ..... 687, 688  
 Dimensional Measurements ..... 368  
 Diode Array Spectrophotometers ..... 668  
 Directional Bridges ..... 221-222  
 Directional Couplers ..... 363  
 Distortion Analyzers ..... 203, 207-208  
 Distribution Amplifier ..... 512  
 Doubler, Frequency ..... 409  
 Down Converters ..... 187, 409  
 Drafting Plotters ..... 696-700  
 Drafting, Mechanical Engineering ..... 662-665  
 Driver, Attenuator/Switch ..... 355  
 Dual Arbitrary Waveform Generator ..... 438, 464  
 Dual Tracking Power Supplies ..... 482, 492, 500-501  
 Dual VHF Switch Module ..... 619  
 Dynamic Signal Analyzers ..... 157, 161-164, 206
- 
- E**  
 EDIF ..... 657  
 EMC Analyzers ..... 173  
 EMC Design Systems ..... 196-201  
 EMI Measurement Systems ..... 196-197, 199-201  
 EW Receiver Test Simulation ..... 402-403  
 Echocardiography ..... 670  
 Economy RF ..... 374-378  
 Education Support ..... 726-728  
 Eight-Pen Plotters ..... 694-699  
 Electronic Clocks ..... 506-508  
 Electronic Counters ..... 102, 106-117, 120-143  
 Electronic Design Automation ..... 658-660  
 Electronic Loads ..... 466-469  
 Electronic Mail ..... 680  
 Electronic Warfare Simulation ..... 402-403  
 Electrostatic Plotters ..... 700  
 Embedded microprocessor system development ..... 648-653  
 Encapsulator ..... 654  
 Enclosure, Weatherproof ..... 255  
 Environment, Software Development ..... 654  
 Environments, Operating ..... 736  
 Error Detectors, Gigabit ..... 552  
 Error-Performance Analyzer ..... 548  
 Express Fixturing System ..... 546  
 Extender, HP-IB ..... 581  
 Extractor, Supercritical Fluid ..... 669

<b>F</b>	
FDM Measurement Systems .....	554
FDM Network Monitoring Systems .....	554
FET Multiplexers .....	594-595
FM Modulation Analyzers .....	106, 209, 215
FM Signal Generators .....	394, 396-397, 404-405, 408
Fiber Optic Cable .....	332
Fiber Optics, Test Equipment	
-See Lightwave Test Equipment	
Fiber Optics	
Amplified Lightwave Converter .....	335, 337
Cables .....	332, 666
Connectors .....	666
Interferometer .....	335-337
Lightwave Signal Analyzer .....	334, 335, 337
Optical Time Domain Reflectometer .....	328
Transmitters/Receivers .....	666
Fiber Patchcords .....	331
Filters	
High Pass .....	224
Low Pass .....	224, 364
Waveguide .....	364
Financing .....	734
Fixtures .....	546
Fourier Analyzers .....	156-157, 161-165, 167-168
Free Publications .....	760
Frequency Agile Signal Simulation .....	402-403
Frequency Selective Meter and	
Tracking Oscillator .....	202, 554
Frequency and Time Domain Analyzers .....	156-165, 167-168, 202
Frequency and Time Standards .....	506-513
Frequency	
Analyzer .....	106
Counters .....	89-91, 102, 106-117, 120-143, 583
Doublers .....	409
Meters, Coaxial and Waveguide .....	363
Sources .....	506, 508-510
Stability Analyzer .....	106, 204
Synthesizers .....	374, 376-378, 380-383, 385-394, 396-399, 433-436, 443-444, 447, 506, 508-510
Function Generators .....	428-431, 433-447
Functional Test Manager Software .....	603, 612

<b>G</b>	
GC/MS Systems .....	669
Gage, Connector, 2.4mm and 3.5mm .....	361
Gas Chromatography .....	669
General-purpose Instrumentation, Training .....	727
Generators	
AM-FM-Pulse .....	394, 396, 408
AWS Baseband Signal Simulation .....	400
Arbitrary Waveform .....	80, 400, 430, 434-436, 438, 464
CW .....	392-393
Cavity-tuned .....	408
Data .....	278, 462-463
Delay .....	448-452, 454-458, 460-461
Digital Modulation .....	404-405
Digital Signal .....	438
Frequency and Time .....	506-509
Function/Sweep .....	625
Function .....	428-431, 434-447, 625
Noise .....	434-436
PRBS .....	464, 548-549, 551
Pattern PRBS .....	552
Pattern .....	462-463, 548-551

Phase Modulation .....	404-405
Pulse/Function .....	400, 428-431, 434-446, 448-449
Pulse/Pattern .....	463
Pulse .....	430, 448-452, 454-456, 458-461
Signal .....	372-374, 376-378, 380-383, 385-394, 396-400, 404-408, 557
Square Wave .....	428-431, 434-447
Sweep .....	410-411, 414-423, 428-430, 443-447, 625
Synthesized .....	392-394, 396-397, 428-429, 445-446, 625
Timing .....	457
Vector Modulation .....	404-405, 557
Vector .....	404-405, 464
Waveform .....	400, 428-430, 434-436, 443-447
Word .....	464, 516-517, 548, 551
Government Sales .....	737
Graphics	
Business .....	695
Displays .....	684
Plotters .....	82, 694-700
Printers .....	689-692
Software .....	82, 681
Supplies .....	693
Tablets .....	687
Technical Computers .....	644-645
Terminals .....	685

<b>H</b>	
HDA Simulator .....	400
HILO Logic Simulator .....	657
HP BASIC	
HP BASIC/UX .....	604
HP Measurement Coprocessor .....	606
Self-study Course .....	606
HP Basic System Maintenance Service .....	725
HP ConsultLine .....	731
HP Customer Return Repair Service .....	723
HP Customer Service Centers .....	723
HP Design Capture System .....	657-658
HP Design Verification Interface .....	657
HP Financing .....	734
HP IBASIC .....	629
HP ITG Interactive Test Generator Software .....	603, 610, 621
HP Printed Circuit Design System .....	657-658
HP-GL/2 .....	695
HP-GL .....	695
HP-IB	
Cables .....	579
Channel Selector .....	553
Digital Clock .....	580
Extenders .....	581
Frequency Counters .....	106-117, 120-142
General Information .....	574-578
HP-IB Interface and Command Library .....	606
Logic Analyzers .....	258
Oscilloscopes .....	54, 276
Power Meters .....	144-145, 212
Power Supplies .....	484-485
Relay Actuators .....	580, 598, 615
Signal Sources .....	430, 434-436, 438-444, 447
Spectrum Analyzers .....	152, 157-165, 167-168, 173-193, 196-201
Switch Controller .....	619
Switch Driver .....	355
Switch Test Unit .....	615
Switch/Control Unit .....	619
Switches .....	356-357

# ALPHABETICAL INDEX

Time Synthesizer .....	457
VHF Switches .....	580, 619
HP-IB .....	146, 202, 605, 695
HP-UX Controllers .....	604
HP-UX Training .....	728
Handheld Optical Loss Test Set, Power Meter .....	327
Hardware Support .....	722-725
Harmonic Mixers (Coaxial and Waveguide) .....	187
Hewlett-Packard Interface Bus (HP-IB) .....	580-581
High-Performance RF .....	380, 382, 387
High-Sensitivity Power Sensors .....	148

## I

I/Q Tutor Digital Training Program .....	556
I/Q Vector Modulation Analyzer .....	206
I/Q Vector-Modulated Generator (VAWS) .....	402-403
IC Design Analysis Software .....	515
IC Design and Prototype Verification System .....	516-517
IC Test Systems, Analog .....	519
IC Test Systems, Digital .....	516-517
IC Testers, Digital .....	294-298, 515, 518-519, 532, 540-546
IC-CAP .....	515
IC-MS .....	515, 539
IDACOM PT300, PT500 .....	562-563
ISDN Protocol Analyzer .....	560-561
ISDN Testers .....	558
Impedance Analyzers .....	302, 304, 306-307
Impedance Meter .....	302
Impedance Transformers, 50-75 Ohm .....	188
Impedance/Gain-Phase Analyzer .....	302, 304
Indicators, LED .....	666
Inductor .....	319
Infrared Detector .....	669
Injector, Automatic .....	669
Inkjet Printers .....	689-690, 692
Installation Services .....	725, 731
Instrument Controllers .....	609
Integrated Test Systems .....	257
Integrators .....	668
Interactive Test Generator .....	603, 610, 621
Interface Boxes .....	195
Interface Bus (HP-IB) .....	580
Interface Kits Multiprogrammer .....	635
Interference & Noise Test Set .....	555
Interferometers, Laser .....	366-369
Interferometers, Lightwave Accessory .....	336
Interrupt Card, Multiprogrammer .....	637
Isolators	
Optical .....	330
Waveguide .....	363

## J

Jitter Generation & Measurement .....	235, 548-551
Jitter Test Sets .....	547
Jitter, Time Interval Analyzer .....	106

## K

Kits, Fiber Optic Link .....	666
Kits, Rack Mounting .....	714-721

## L

LAN Cable Testing .....	568-569
LAN Protocol Analyzer .....	564
LAN Testers .....	558
LC/MS Systems .....	668
LCR Meters .....	308-309, 312, 316
LCZ Meters .....	316
LED Displays, Indicators .....	666
LED-Sources .....	330
LIF Utilities .....	606
LSI Test System .....	519
Laboratory Automation Systems .....	668
Languages, Training .....	727
Laser	
Interferometers .....	366, 369
Machine Tool Calibration .....	369
Position Transducer .....	366
Printers .....	691-692
Sources .....	324-325, 325, 330
Transducer System .....	366
Leasing .....	734
Light Bar Modules, LED .....	666
Light Emitting Diodes .....	666
Lightwave Multimeter .....	324-325
Lightwave	
Amplified Lightwave Converter .....	335, 337
Attenuating Lens Adapter .....	331
Component Analyzer .....	332
Directional Coupler .....	332
Fiber-optic Interferometer .....	335, 337
LED-Sources .....	330
Laser Sources .....	330
Lightwave Multimeter .....	324
Loss Test Set .....	324-325
Optical Heads .....	324
Optical Isolators .....	330
Optical Loss .....	327
Optical Power Splitters .....	331
Optical Pulse Power Meter .....	323
Optical Time Domain Reflectometer .....	328, 329
Patchcords .....	331
Power Meter .....	324-325
Signal Analyzers .....	334-337
Limiters .....	188
Liquid Chromatography .....	668
Logic Analyzers	
Accessories .....	265
CAE Links .....	279
Microprocessor Support .....	262-264
Preprocessors .....	265, 628
State Analysis .....	274
User-definable Interfaces .....	265
VXI .....	628
Logic	
Analyzer Training Courses .....	728
Analyzers .....	258-293
Current Tracer .....	297
Development systems .....	648-653
Pattern Generators .....	278
Probes .....	278, 297
Pulser .....	297
Signal Sources .....	448, 462-463



<b>M</b>	
MAP Protocol Analyzer .....	560-561
MATE Power Meter .....	146
MMIC/MIC Test Systems .....	257
MMS - see Modular Measurement System	
MOTIF .....	644
Mail, Electronic .....	680
Maintenance Service .....	725
Mass Selective Detectors .....	669
Mass Spectrometers .....	669
Materials Measurement Systems .....	254
Matrix Switches	
(HP-IB) .....	355-357, 525, 615-620
Custom .....	355
Microwave .....	355-357
Measurement Graphics Software .....	82
Measurement Personalities	
CATV .....	173-174
Digital Radio .....	173-174, 179-180
EMC .....	174
Measurement Plotting System .....	82
Measurement Software .....	342
Measurement System Calibration Service .....	725
Measurement Systems Architecture .....	3-5, 189-195, 602-603
Measuring Receiver .....	211, 215
Mechanical Engineering	
DesignCenter .....	662
Design .....	662, 664
Drafting Plotters .....	696-699
Drafting .....	662, 664
Solids Modeling .....	662, 664
Test .....	156-165, 167-168, 662, 664
Medical Instrumentation .....	671
Memory Card, Multiprogrammer .....	637
Meters	
AC .....	84-99
Capacitance .....	534
Distortion .....	202-203, 207, 209, 211-212
Frequency .....	89, 106-112, 114-117, 120-143, 365, 583
Impedance .....	302, 306-308
LCR .....	308
Low Resistance .....	94
Modulation .....	106, 206
Multifunction .....	84-99
Multimeter .....	84-99
Noise Figure .....	345
Ohmmeter .....	84-99
Peak Power .....	151
Phase .....	106, 161-164, 229
Picoampere .....	532
Power/Counter .....	147
Power .....	144-151, 212-215
Q Meter .....	308
Signature .....	294, 296
Susceptance .....	308
Time Interval .....	106, 112
True RMS .....	84-99
pA Meter .....	532
Microcircuit .....	360
Microprocessor Development Environment .....	648-653
Microprocessor Development, Training .....	728
Microprocessor Support	
Advanced Micro Devices (AMD) Microprocessors .....	262
Analog Devices Microprocessors .....	262
GTE Microprocessors .....	262
HP-IB Bus Support .....	264
Hitachi Microprocessors .....	262
Intel Microprocessors .....	262
Motorola Microprocessors .....	263
NEC Microprocessors .....	263
National Semiconductor Microprocessors .....	263
Rockwell Microprocessors .....	264
Texas Instruments Microprocessors .....	264
SCSI Bus Support .....	264
Zilog Microprocessors .....	264
Microprocessor Troubleshooting .....	294, 296
Microwave Digital Radio Test .....	556-557
Microwave Linear Simulator .....	661
Microwave Nonlinear Simulator .....	661
Microwave Radio	
Fading Test .....	555
Noise and Interference Test Set .....	555
Portable Counter/Power Meter .....	118
Microwave	
Amplifiers .....	426-427
Attenuator Calibration .....	213
Counters .....	115, 127, 130
Design System (CAE) .....	661
Diodes .....	667
Down-Converter .....	108-111, 215
Interface Boxes .....	195
Measurement System .....	215
Modulators .....	215
Network Analyzers .....	216, 219-225
Noise Figure Meter .....	345
Noise Figure Test Set .....	346
Power Measuring Equipment .....	144-151, 211
Power Sensor .....	215
Preamplifiers .....	189-193, 427
Semiconductors .....	667
Sensor Module .....	215
Signal Generator Test .....	214
Signal Generators .....	392-394, 396-397, 404-405, 408
Spectrum Analyzers .....	174-184, 186, 189-193
Sweep Oscillators .....	410-411, 414-423
Switch Driver .....	194
Switches .....	627
Synthesizers .....	380-383, 385-394, 396-399
Test Accessories .....	352, 355-357
Test Equipment .....	350-351, 358-359, 361, 363-365
Training .....	727
Transistors .....	667
VXI .....	627
Military Standard Agreements .....	724
Millimeter Wave Instrumentation	
Adapters .....	365
Attenuators .....	364
Bends .....	365
Counters .....	127
Detectors .....	359
Directional Couplers .....	363
Frequency Meters .....	363
Harmonic Mixers .....	187
Isolators .....	363
Mismatches, Waveguide .....	365
Network Analyzer .....	221, 250
Power Sensors .....	148
Preselected Mixers .....	187
Shorts .....	361
Spectrum Analyzers .....	179-183, 183-184
Straight Sections .....	365
Sweep Oscillator .....	421
Swept Signal Generator .....	394
Synthesized Signal Source .....	394

# ALPHABETICAL INDEX

Synthesized Sweeper .....	393, 396
Terminations .....	361
Twists .....	365
Milliohmmeters .....	94, 320
Miniature Link Components .....	666
Mismatches, Coaxial Sliding .....	361
Mixers, Coaxial and Waveguide .....	187, 350
Mixers, Double-Balanced and Harmonic .....	350
Modal Test .....	165
Modems .....	404
Modul Analysis .....	166
Modular DC Source Monitor .....	530
Modular Measurement System (MMS)	
Lightwave Signal Analyzers .....	334
Power Meter .....	145
Preamplifier, RF .....	425
Preamplifier, microwave .....	427
Signal Analyzers .....	189-195
Switch/Attenuator Driver .....	355
Vector Voltmeter .....	245
Modular	
Preamplifier, RF .....	425
Preamplifier, Microwave .....	427
Spectrum Analyzers .....	187
Modulation Analyzers, Vector I/Q .....	206
Modulation Analyzers .....	106, 206, 209, 342
Modulation Domain Analyzers .....	106
Modulation Test Source .....	404-405, 556
Modulation, Vector Signal Generator .....	557
Modulator/Demodulator .....	404-405
Modulators, I/Q, Vector .....	404-405
Module, Mixer .....	255
Monitors .....	684
Multichannel Measurement System .....	165, 167-168
Multifunction Synthesizer .....	434
Multimeter, Signature .....	294
Multimeters .....	84-99, 294, 594-595, 623
Multipath Fading Simulator, Radio .....	555
Multiplex (Primary) Analyzer .....	553
Multiplexers .....	89, 583, 586, 594-596, 598, 615, 619, 626-627
Multiprogrammers .....	637

## N

Network Analyzers	
Automatic .....	229, 248
Frequency and Time Domain .....	156, 158-160
Impedance/Gain-Phase .....	302
Microwave .....	257
Pulsed, RF .....	256
Scalar .....	219-228
Vector .....	161-164, 229-233, 236, 238-253, 302
Networked Computer Systems .....	678-681
NewWave .....	678
Noise Figure, Measurement System .....	344, 346
Noise Figure, Microwave .....	344-346
Noise Figure/Gain Circles .....	344
Noise and Interference Test Set .....	555
Noise	
Generator .....	434-436
Measurements .....	204

## O

OEM	
Computers .....	642-643
Displays, CRT .....	684-685
Graphics Plotters .....	694-700
Laser .....	691
Measurement Plotting System .....	82
Microwave Components .....	667
Microwave Crystal Detectors .....	358-359
Microwave Switches .....	355-357
Optoelectronic Components .....	666
Power Supplies .....	470
Printers .....	689-692
OTDR .....	328-329
Obstetrical Information Management System .....	671
Offices, Sales and Support .....	737
Ohmmeters .....	84-99
Opens, Coaxial .....	361
Operating Environments .....	736
Optical Attenuators .....	326
Optical Heads .....	324-325
Optical Isolators .....	330
Optical Loss Test Set, Handheld .....	327
Optical Loss Test Set .....	324-325
Optical Power Meter .....	324-325
Optical Power Splitter .....	331
Optical Time Domain Reflectometer .....	328-329
Optical storage .....	686
Optocouplers .....	666
Optoelectronics .....	666
Ordering Information .....	735
Oscillators	
Function .....	428-431, 434-447
General Information .....	410
Low Frequency .....	428-430, 434-436, 443-446, 554
Sine wave .....	443
Sinewave .....	428-429, 434-436, 444-447, 554
Squarewave .....	430-431, 434-447
Sweep .....	207, 387, 410-411, 414-423, 428-431, 434-436, 443-447, 554
Synthesized Sweep .....	393-394, 396, 428-429, 434-436, 443-447
Oscilloscopes	
Accessories .....	72-76, 76
Digital Waveform Storage .....	64-65, 67
Digitizing .....	58-71, 625
General Information .....	54
HP-IB .....	68-71
Precision .....	68-71, 78-81
Probes .....	72-73
Sampling .....	71
Selection Guide .....	56-57
VXI .....	625

## P

PC Applications .....	681
PC Board Testers .....	540-546
PCL5 .....	691
PCM Test Equipment .....	549, 551, 553
PIN Diodes .....	667
PRBS Generators .....	464
PT300, PT500 .....	562
Parameter Extraction Software .....	515
Parametric Test Software .....	515, 539
Pattern Generator & Error Detector .....	549
Pattern Generator/Pulse Capability .....	463

Pattern Generators  
 Digital ..... 438, 464  
 Gigabit ..... 552  
 Peak Power Analyzer ..... 144  
 Peak Power Meters ..... 144, 151  
 Permittivity Measurement Systems ..... 254  
 Personal Computer Instrument Controllers ..... 607-608  
 Personal Computers ..... 682  
 Phase Comparator ..... 231, 511  
 Phase Meters ..... 106, 161-164, 229, 231  
 Phase Modulation Analyzers ..... 106, 206, 209  
 Phase Modulation Generator ..... 404-405  
 Phase Noise Measurement ..... 204  
 Planar-doped-barrier detectors ..... 358, 359  
 Plotters, Drafting ..... 696-700  
 Plotters, Graphics ..... 82, 694-695  
 Portable  
 AC Power Source ..... 178  
 Counter/Power Meter ..... 118  
 Portable Lightwave Signal Analyzer ..... 335, 337  
 Spectrum Analyzers ..... 173-183, 187  
 Position Measurement, Laser ..... 367  
 Power Amplifiers ..... 425-426  
 Power Dividers ..... 224  
 Power Meter Calibrators ..... 147, 150  
 Power Meters  
 MMS Module ..... 145, 146, 189-193  
 Meter/Counter ..... 118  
 Meter/Measuring Receiver ..... 211  
 RF & Microwave ..... 144-148, 150, 211  
 VXI ..... 628  
 Power Products ..... 484-485  
 Power Sensors, RF & Microwave ..... 148, 151, 212  
 Power Source ..... 178, 188  
 Power Splitters  
 Coaxial ..... 224, 226, 243  
 Optical ..... 331  
 Power Supplies  
 Amplifier/Power Supply ..... 474  
 Atomic Clock ..... 513  
 Bench ..... 474, 500  
 Condensed Listing ..... 474-475  
 Constant Current Sources ..... 505  
 Digitally Controlled ..... 475, 484-486  
 Frequency Standards ..... 513  
 HP-IB Programmable ..... 470-473, 475, 477-487, 490-491  
 Laboratory ..... 470-471, 473, 475, 478-487, 490-491  
 Modification Service ..... 475  
 Multiprogrammer Control ..... 473, 475  
 Output Isolation Relays ..... 488  
 Polarity Reversal Relays ..... 488  
 Precision Current, Voltage Sources ..... 433  
 Programmable ..... 470-474, 477, 484-485  
 Standby ..... 513  
 Preamplifiers ..... 189-193, 427  
 Precision Coaxial Connectors ..... 707  
 Precision DC Voltage or Current Source ..... 433  
 Precision Digitizing Oscilloscopes ..... 78-81  
 Precision Frequency Sources ..... 506-513  
 Precision Oscillator ..... 510  
 Precision Time Interval Counters ..... 106, 112  
 Preselectors ..... 198  
 Pressure Probes, Quartz ..... 370  
 Primary Multiplex Analyzer ..... 553  
 Printed Circuit Design System ..... 659  
 Printers  
 Bar Code ..... 691

Color ..... 689  
 Desktop Publishing ..... 690-691  
 Dot Matrix ..... 690-692  
 Graphics ..... 690-692  
 Impact ..... 690-691  
 Inkjet ..... 690  
 LAN ..... 691  
 Laser ..... 691-692  
 Line Impact ..... 692  
 Mac-connect ..... 689  
 Network ..... 691  
 Page ..... 691  
 Probes  
 Accessories ..... 99, 297  
 Digital Multimeter ..... 99  
 High Frequency ..... 99, 188, 239, 556  
 High Impedance ..... 556  
 High Voltage ..... 99  
 Logic ..... 297  
 Pressure Quartz ..... 370  
 Spectrum/Network ..... 232  
 Temperature ..... 371, 371  
 Voltage Divider ..... 99  
 Product Notes ..... 760  
 Programmer Starter Kit ..... 400  
 Protocol Analyzers ..... 559-561  
 Pulse Generators ..... 430-431, 448-452, 454-458, 460-461  
 Pulse Width/Duty Cycle Analyzer ..... 106  
 Pulse/Function Generators ..... 400, 428-431, 434-444, 449  
 Pulsed-RF Network Analyzer ..... 256

**Q**

Q Adapter ..... 311  
 Q Meter ..... 319  
 Quartz Frequency Standard ..... 510  
 Quartz Thermometer ..... 371  
 Quasi-Peak Adapter ..... 198

**R**

RF  
 Amplifiers ..... 425  
 Impedance Analyzer ..... 245  
 Network Analyzer ..... 229, 238, 240-241, 243-244  
 Preamplifiers ..... 189-193  
 Preselector ..... 198  
 Signal Generators ..... 372-373  
 Spectrum Analyzers ..... 173-176, 178-182, 184, 189-193  
 Switch ..... 355-357, 615  
 Switches ..... 627  
 Time and Frequency Analyzers ..... 78-81, 106  
 Transceiver Test Systems ..... 338  
 VXI ..... 627  
 RMS Voltmeters ..... 84-99  
 Rack Mount Kits ..... 714-721  
 Rack Slides ..... 715-716, 718-719  
 Rackmountable Controller ..... 609  
 Radar Cross Section (RCS) Measurements ..... 255  
 Radar Signal Simulator ..... 402-403  
 Radio System Testing ..... 106  
 Radio Test Systems ..... 338  
 Radio Test, Microwave Digital ..... 557  
 Radio Test, Microwave  
 Fading Simulator ..... 555

# ALPHABETICAL INDEX

Noise and Interference Test .....	555
Range Calibrator (for HP 435B Power Meter) .....	147
Receiver, Measuring .....	211
Recorders	
Measurement Plotting System .....	82
Waveform .....	78-82
X-Y .....	82
Reflection/Transmission Test Sets .....	240-241
Reflectometer, Optical Time Domain .....	328
Relay Actuators (HP-IB) .....	580, 598, 615, 619
Relay Multiplexers .....	594-595, 626
Relay Output Card, Multiprogrammer .....	637
Repair Agreements .....	723-724
Resistance Meters .....	84-99
Resolution Enhancement, Laser .....	691
Rewritable Optical Library System .....	686
Rewritable Optical Disk Drive .....	686
Rotary Vane Attenuators, Waveguide .....	364
Rubidium Frequency Standard .....	509

## S

S-Parameter Test Sets .....	240-241, 249
SCPI (TMSL) .....	602
Sales Offices .....	737
Sample Preparation .....	669
Scalar Network Analyzers .....	226-228
Schottky Diodes .....	667
Secondary Storage .....	686
Selective Level Voltmeters .....	202, 554
Semiconductor Parametric Test System .....	520-523
Semiconductor Test Equipment .....	516-524, 536-537
Semiconductor/Component Test Systems .....	516-517, 519
Sensor Module .....	148, 212, 215
Sensors, Power .....	148, 151, 215
Sensors, Thermistor .....	151
Service Information .....	760
Servo Electronics .....	367
Sheet-Feed Drafting Plotter .....	699
Shipping .....	735
Shorts, Coaxial .....	361
Shorts, Waveguide .....	361
Signal Analyzers	
Attenuator Calibration .....	213
Audio .....	156-165, 167-169, 171-172, 207
Distortion .....	209
Frequency and Time Interval .....	106
Modular .....	189-195
Modulation .....	106, 206, 209, 341
Phase Noise .....	106, 204
Signal Generator Test .....	214, 215
Spectrum Analyzers .....	177, 196-197, 199-201
Spectrum .....	169, 171-176, 178, 180-186, 188-193, 198, 204, 232
Time Interval .....	106
Waveform .....	82, 157, 161-165, 167-168, 189-193, 206
Signal Generators	
AM-FM Pulsed .....	397
CW .....	392-393
Digital .....	438
General Information .....	372
Generator/Recorder .....	80
HF, VHF, UHF, SHF .....	374-377, 380-383, 385-394, 396-400, 404-405, 443-444, 447
Microwave .....	392-394, 396-397
Modular .....	189-193
Performance Test System .....	214

Programmable .....	374-377, 380-383, 385-394, 396-399, 440, 442
Pulsed .....	394, 396
Service Kits .....	383, 389, 397
Sweep .....	410-411, 414-423, 428-430, 443-444, 447
Swept .....	393-394, 396
Synthesized .....	374-377, 380-383, 385-394, 396-399, 428-431, 434-439, 441-447
VOR Modulator .....	434-436
Vector I/Q .....	342-343
Vector, I/Q .....	404-405
Signal Simulation System .....	400-403
Signal Sources, Programmable .....	374-378, 380-383, 385-391, 398-399, 428-429, 434-436, 438-447, 451
Signal Sources .....	374-378, 380-383, 385-391, 398-399, 410-411, 414-423, 428-431, 434-439, 441-447, 450-452, 455, 460-464
Signaling, RF Radio .....	434-436
SimPlate Fixture Series .....	546
Simulation, Signal .....	400
Simulator	
Radar Threat .....	402
Signal .....	402
Single Sideband Phase Noise Test System .....	204
Sliding Loads (Coaxial and Waveguide) .....	361
SoftBench .....	654
Software Support, Test and Measurement .....	730
Software	
Active Device Measurement .....	251
Antenna Measurement .....	255
Applications Solutions .....	645-647, 658, 661-665, 681
Applications .....	657, 659
Basic Network Measurement .....	247
CAD .....	645-647, 657-659, 661-665
CAE .....	657-659
CASE .....	646
Cellular Radio Test .....	339
Circuit/Device Modeling .....	515
Datacom .....	681
EMI Measurement .....	199-200
Electronic Design .....	645, 657-659
Engineering System .....	654
Functional Test Manager .....	612
Graphics .....	681
HP ITG .....	603, 610, 621
Mechanical Design & Drafting .....	662, 664
Mechanical Engineering .....	662, 664
Microwave Measurement System .....	215
Network Measurement .....	247
Parameter Extraction .....	515
Radiated Emissions Measurement .....	199-200
Scalar Network Analyzer .....	227
Signal Generator Test .....	214
Solutions .....	657, 659
Spreadsheets .....	681
Support Service .....	722, 730
Terminal Emulation .....	681
Transceiver Test .....	339
Transmission Line Test System .....	228
Vector Network Analyzer .....	247
Waveform Generator .....	81, 400
Waveform Measurement .....	79
Solid State Displays, Optocouplers, Fiber Optics, Relays .....	666
Source, Avionic .....	434-436
Source, DC .....	433
Source, Signal .....	374-377, 380-383, 385-391, 398-399, 410-411, 414-423, 428-431, 433-436, 438, 443-447, 464
Spectrum Analyzer Accessories .....	201

Spectrum Analyzer Preselector ..... 198  
Spectrum Analyzers ..... 106, 171-176, 189-193, 196-197, 199-200  
Standards, Frequency and Time ..... 506-510, 513  
Standby Power Supply ..... 513  
Step Attenuators, Coaxial ..... 354  
Structural Test ..... 165  
Support, Customer ..... 727-728  
Sweep Oscillators ..... 387, 410-411, 414-423, 428-430, 434-436, 443-447, 554  
Sweep Signal Generators ..... 410-411, 423, 428-430, 443-447  
Sweep Synthesizers ..... 443-447, 554  
Swept Signal Generators ..... 393-394, 396  
Switch Controller, HP-IB ..... 619  
Switch Driver ..... 194, 355  
Switch Matrix ..... 195  
Switches  
AC Power Controller ..... 586  
Actuators ..... 89, 583, 586  
Coaxial, Five-Port ..... 355-357, 583  
Coaxial, Microwave OEM ..... 355-357  
Driver ..... 194, 355  
Form C ..... 626  
Matrix (HP-IB) ..... 615, 619  
Matrix ..... 195, 626  
Microwave ..... 626-627  
RF ..... 627  
SP-Multi-Throw ..... 355  
Switch/Test Unit ..... 615  
VXI System ..... 594-595  
Synthesized Function Generators ..... 400, 430, 434-436  
Synthesized Function/Sweep Generator ..... 625  
Synthesized Signal Generators ..... 374-377, 380-383, 385-393, 396, 398-399, 430, 434-436, 447  
Synthesized Signal Sources ..... 394, 397, 434-436, 443-444, 447  
Synthesizer, Arbitrary Waveform ..... 400, 430  
Synthesizer, Audio Complex ..... 434-436  
Synthesizer, Time ..... 457  
Systems  
Analog LSI Test ..... 519  
Attenuator Calibration ..... 213, 215  
Automatic Test ..... 638  
Board Test ..... 540-545  
CAD ..... 662, 664  
Combinational Test ..... 540-545  
Communications Test ..... 540-545  
Computer-Aided Engineering (CAE/CAD) ..... 645, 647, 657-659, 661, 664-665  
Data Acquisition ..... 583, 586, 598  
Digital IC Test ..... 516-517  
EMC Design ..... 196-197, 199-201  
IC Prototype Verification ..... 516-517  
In-Circuit Test ..... 540-545  
LSI Test ..... 519  
Microwave Measurement ..... 215  
Modular Measurement System ..... 189-195  
Semiconductor Test ..... 516-517, 519  
Signal Generator Test ..... 215  
Surface Mount Technology Test ..... 542-543  
Transceiver Test ..... 338  
Transmission Line Test ..... 228  
Waveform Generation ..... 81, 400  
Computer-Aided Software Engineering ..... 648-653  
Microprocessor Development ..... 648-653

T

Tape Storage ..... 686  
Telecommunications Test Equipment  
Audio Channel Selector: HP-IB Controlled ..... 553  
Balanced 2/4-wire Audio Channel Selector ..... 553  
Bit Error Ratio Measurements ..... 548, 551  
Cellular Radio Test Equipment ..... 338  
Constellation Analyzer ..... 206, 556  
Counter/Power Meter ..... 118  
DS3 Transmission Test Set ..... 551  
Digital Data Test Set ..... 550  
Digital Modulation Analyzer ..... 206  
Digital Modulation Generator/Analyzer ..... 404-405  
Digital Transmission Analyzer ..... 548-549, 551  
Digitizing Oscilloscopes ..... 79  
Error Detectors ..... 552  
Error Ratio Measurements ..... 548, 552  
FDM Measurements ..... 554  
Frequency Analyzer ..... 106  
HP-IB Controlled Channel Selector ..... 553  
Jitter Generator & Receiver ..... 548  
Jitter, Time Interval Analyzer ..... 106  
LAN Protocol ..... 566  
Microwave Network Analyzers ..... 228, 239, 244, 250-253  
Modulation Analyzers ..... 106  
Modulator/Demodulator ..... 404-405  
PCM Testing ..... 106, 549-550, 553  
Pattern Generator & Error Detector ..... 549  
Power Meters ..... 151  
Spectrum Analyzers ..... 156-165, 167-168, 183, 189-193  
Time Interval Analyzer ..... 106  
Transmission Impairment Measuring Sets ..... 572  
Transmission Line Test Sets ..... 228  
Vector Modulation Analyzer ..... 206  
Vector Modulation Generator/Analyzer ..... 404-405  
Voice & Data Testing ..... 570  
Waveform Analyzers ..... 78-82, 106, 157, 161-165, 167-168, 189-193, 206  
Temperature Measurement ..... 371, 583  
Thermistor Assemblies ..... 151  
Thermocouple Multiplexers ..... 626  
Threat Simulator, Radar ..... 402-403  
Time Interval Analyzer ..... 106  
Time and Frequency Domain ..... 156  
Time, Frequency Domain Analyzers ..... 78-81  
Tracking Generators ..... 189-193  
Tranceiver Test Equipment ..... 342, 343  
Transient Digitizers ..... 81, 156-165, 167-168  
Transient Generators ..... 80, 400  
Transient Recorders ..... 157, 161-165, 167-168  
True RMS Voltmeters ..... 86-89, 91-99  
Twisted-pair Cabling ..... 568-569  
Type N Short ..... 361

U

UHF Signal Generators ..... 404-405  
US Government Sales ..... 737

V

VXI  
Backplane Extension ..... 628  
Command Module ..... 629

## ALPHABETICAL INDEX

Controller .....	629
Counter Totalizers .....	624
Counters .....	624
D/A Converters .....	625
Data Acquisition .....	594-595
Development Tools .....	628-629
Digital I/O .....	625
Digital Multimeter .....	594-595
Digitizing Oscilloscope .....	625
Function/Sweep Generators .....	625
HP IBASIC .....	629
Logic Analyzer Preprocessor .....	628
Mainframes .....	594-595, 622, 628
Matrixes .....	626
Module Carrier .....	628
Multiplexers .....	594-595, 626-627
Power Meter .....	628
Switches .....	594-595, 626-627
Universal Counters .....	624
VXIbus Family .....	621-622, 630
Value-added software solutions .....	660
Vector Analyzer .....	206
Vector Generator .....	343
Vector Modulation, Signal Generator .....	557
Vector Network Analyzers .....	161-164
Vector Voltmeter .....	189-193, 245
Vetra PC System .....	561, 683
Verification kits (Network analyzers) .....	252
Vibration Analyzers .....	157, 165, 166
<b>W</b>	
WAN Protocol Analyzer .....	558-561
Waveform	
Adapters .....	365
Analyzers .....	82, 161-164
Attenuators .....	364
Digitizers .....	81, 167-168
Generator, Arbitrary .....	80
Recorders .....	82
Waveguide	
Bends, Twists .....	365
Directional Couplers .....	363
Frequency Meters .....	363
Holders .....	364
Low-Pass Filters .....	364
Sliding Loads .....	361
Sliding Shorts .....	361
Stands .....	364
Wire Test Instrument .....	568-569

# MODEL NUMBER INDEX

New product listings are printed in bold face type

39

---

## 10

10B Business Calculator (Algebraic) .....	676
10BASE-T products .....	568-569
12C Programmable Financial Calculator (RPN) .....	676
17BII Financial Calculator (RPN/Algebraic) .....	676
19BII Business Consultant (RPN/Algebraic) .....	676

---

## 20

20GB/A Optical Disk Library System .....	686
20S Scientific Calculator (Algebraic) .....	676
21S Stat/Math Calculator (Algebraic) .....	676
28S Advanced Scientific Calculator (RPN) .....	676

---

## 30

32S Scientific Calculator (RPN) .....	676
---------------------------------------	-----

---

## 40

42S Scientific Calculator (RPN) .....	676
---------------------------------------	-----

---

## 100

105B Quartz Oscillator .....	510
------------------------------	-----

---

## 200

214B Pulse Generator .....	458
281 Series Coaxial-Waveguide Adapters .....	365
292 Series Waveguide-Waveguide Adapters .....	365

---

## 300

334A Distortion Analyzer .....	203
339A Distortion Measuring Set .....	203
346A/B/C Noise Sources .....	347
346C OPT K01 Noise Source .....	347
347B Series Waveguide Noise Sources .....	347
355 Series Coaxial Step Attenuators .....	352-353
362A Series Waveguide Low-pass Filters .....	364
365 Series mm-Wave Waveguide Isolators .....	363
370 Series mm-Wave Fixed Attenuators .....	364
373 Series mm-Wave Fixed Attenuators .....	364
382 Series Waveguide Precision Variable Attenuators .....	364

---

## 400

415E SWR Meter .....	225
422A/C Series Waveguide Crystal Detectors .....	358-359
423B Coaxial Crystal Detector .....	358
432 Series Power Meters .....	150
435B Power Meter .....	147
436A Power Meter .....	146
437B Power Meter .....	145
438A Dual Channel Power Meter .....	146
438A Option 700 MATE - Programmed Power Meter .....	146

478A Coaxial Thermistor Mount .....	151
486A Series Waveguide Thermistor Mounts .....	151

---

## 500

532 Series Waveguide Frequency Meters .....	363
537A Coaxial Frequency Meter .....	363
545A Logic Probe .....	297
546A Logic Pulser .....	297
547A Digital Current Tracer .....	297
548A Logic Clip .....	298

---

## 600

650/A Rewritable Optical Disk Drive .....	686
---	-----

---

## 700

700/22 Display Terminal .....	685
700/32 Display Terminal .....	685
700/41 Display Terminal .....	685
700/43 Display Terminal .....	685
700/44 Display Terminal .....	685
700/92 Display Terminal .....	685
700/94 Display Terminal .....	685
752 Series Waveguide Directional Couplers .....	363
772-773D Directional Couplers .....	362
774-777D Coaxial Dual Directional Couplers .....	362
778D Coaxial Dual Directional Coupler .....	362
779D Coaxial Directional Coupler .....	362

---

## 800

894 Series Waveguide Mismatches .....	365
896 Series Waveguide Precision Straights .....	365
897 Series E-, H-Plane Waveguide Bends .....	365
898 Series Waveguide Twists .....	365
899 Series Waveguide Straight Sections .....	365

---

## 900

905A Coaxial Sliding Load .....	361
908A Coaxial 50-Ohm Termination .....	361
909A/C/D/E/F Coaxial 50-Ohm Terminations .....	361
910 Series Waveguide Terminations .....	361
911C Coaxial Sliding Loads .....	361
911D/E Sliding Loads .....	361
911F/G Sliding Mismatches .....	361
914 Series Waveguide Sliding Loads .....	361
920 Series Waveguide Moving Shorts .....	361
921 Waveguide Fixed Shorts .....	361

---

## 1000

1000 Computers and Systems .....	642-643
1008A Testmobile .....	76
1040M LC Diode Array Detector .....	668
1046A Fluorescence Detector .....	668
1047A Refractive Index Detector .....	668

# MODEL NUMBER INDEX

New product listings are printed in bold face type

1049A Electrochemical Detector	668
1050 Series HPLC Modules	668
1050 Series II HPLC Modules	668
1050 Titanium Series HPLC Modules	668
1051A & 1052A Combining Cases	718
1090 Series II L/M Liquid Chromatography System	668
1090L Liquid Chromatography System	668
1090M Liquid Chromatography System	668
1122A Probe Power Supply	73-74, 76
1124A Active Divider Probe	73-74, 76
1133A TV Video Sync Pod	77
1137A High Voltage Divider Probe	74
1141A Differential Probe	75
1180A Testmobile	76
1250-1530 N(m) Short (75 Ohm)	361
1250-1531 N(f) Short (75 Ohm)	361
1251-2277 Dual Banana Plug to BNC Female	707
1251-2816 Dual Banana Plug (for Cable)	707
1631D + 24D HP 1631A/D Logic Analysis Measurement Techniques Course	727
1650B Logic Analyzer	260
1650B 80-Channel Logic Analyzer	266
1651B Logic Analyzer	260
1651B 32-Channel Logic Analyzer	266
1652B Logic Analyzer	260
1652B Logic Analyzer with Oscilloscope	268
1653B Logic Analyzer	260
1653B Logic Analyzer with Oscilloscope	268
<b>1654B Logic Analyzer</b>	260
1654B 64-Channel Logic Analyzer	266

## 2000

2106CK/DK Board Computer	642-643
2134A Computer	642-643
2139B Computer	642-643
2156C/D Computer	642-643
2196G/H Model 26 Computer Systems	642-643
2199E Model 29 Computer Systems	642-643
2225A/B/C/D/P ThinkJet Personal Printer	690
2227A/B QuietJet PLUS Printer	690
2228A QuietJet Printer	690
2235A/B/C/D RuggedWriter 480 Printer	690
2279A DeskWriter Printer	690
2393A Graphics Terminal	685
2397A Color Graphics Terminal	685
2424A Micro 14 Computer	642-643
2426G/H Micro 16 Computers	642-643
2434A Micro 24 Computer	642-643
2436G/H Micro 26 Computer	642-643
2439B Micro 29 Computer	642-643
2484B Micro 24 Computer	642-643
2486B/C Micro 26 Computer System	642
2486B/C Micro 26 Computer Systems	643
2489B Micro 29 Computer System	642
2489B Micro 29 Computer Systems	643
2562C Dot Matrix Printer	692
2563C Line Impact Dot Matrix Printers	692
2564C Line Impact Dot Matrix Printers	692
2566C Line Impact Dot Matrix Printers	692
2567C Line Impact Dot Matrix Printers	692
2680A Laser Printing System	691
2684A/P/D AP LaserJet 2000	691
2685C Laser Print Station	691
2804A Quartz Thermometer	371

2813D Quartz Pressure Set	370
2813E Quartz Pressure Probe	370
2816A Pressure Signal Processor	370
2934A Business Printer	690
<b>2939A Micro 99 Computer</b>	642-643
<b>2959A Computer</b>	643
<b>2959A Computer</b>	642
<b>2989A Micro 99 Computer</b>	642-643
<b>2999A Model 29 Computer System</b>	642
<b>2999A Model 29 Computer Systems</b>	643

## 3000

3048A Phase Noise Measurement System	204
3048A + 24A HP 3048A Phase Noise Measurement System	727
3065 Board Test Family (HP-IB)	540, 544-545
3065AT Combinational Board Test System	540, 544-545
3065CT Communications Board Test System	540, 544-545
3065ST Standard Technologies Board Test System	540, 544-545
3070 Board Test Family (HP-IB)	540-544
3070 SMT-Series Board Test System	540-544
3070 Series Board Test Systems	543
3070AT-Series Board Test System	540-541, 544
3070AT-Series Combinational Board Test System	542-543
<b>3073 ST-Series</b>	542
<b>3073 Series Board Test System</b>	541
3235A Switch/Test Unit	614-615
3312A Function Generator	430
3314A Function Generator	430
3324A Synthesized Function/Sweep Generator	445-446
3325B Synthesizer/Function Generator	443
3326A Two-channel Synthesizer	444
3335A Synthesizer/Level Generator	447
3336A/B/C Synthesizer/Level Generators	554
3336C Synthesizer/Function Generator	447
3365 ChemStation	668
3396A Integrator	668
3400A RMS Voltmeter	98
3421A Data Acquisition/Control Unit	583
3437A System Voltmeter	95
3455A Digital Voltmeter	95
3456A Systems DVM	94
3457A Multimeter	89
3458A Multimeter	86
3466A Digital Multimeter	98
3468A/B Digital Multimeter	96
3478A Multimeter	92
3488 Switch/Control Unit	614
3488A Switch/Control Unit	619
3497A Data Acquisition/Control Unit	598
3498A Extender	598
3551A Transmission Test Set	572
3552A Transmission Test Set	572
<b>3560A Portable Dual-Channel Dynamic Signal Analyzer</b>	156
3561A Dynamic Signal Analyzer	157
3562A Dynamic Signal Analyzer	163-164
3563A Control Systems Analyzer	161-162
3566A Spectrum/Network Analyzer	167-168
3567A Spectrum/Network Analyzer	167-168
3575A Gain/Phase Meter	231
3577A Network Analyzer	229
3581A Wave Analyzer	202
3581C Selective Voltmeter	202
3585B Spectrum Analyzer	169
3586A/B Selective Level Meter	554



3586C Selective Level Meter .....	202
3588A Spectrum Analyzer .....	171-172
3630A PaintJet Color Graphics Printer .....	689
3708A Noise and Interference Test Set .....	555
3709B Constellation Analyzer .....	556
3764A Digital Transmission Analyzer .....	549
3776A PCM Terminal Test Set .....	553
3776B PCM Terminal Test Set .....	553
3777A HP-IB-Controlled Channel Selector .....	553
3779C Primary Multiplex Analyzer (CEPT) .....	553
3779D Primary Multiplex Analyzer (Bell) .....	553
3784A Digital Transmission Analyzer .....	548, 551
3787B Digital Data Test Set .....	550
3788A Error Performance Analyzer .....	548
3789B DS3 Transmission Test Set .....	551
3852A Data Acquisition/Control Unit .....	586
3852A + 24D HP 3852S User Training Course .....	727
3852S Data Acquisition/Control System .....	586

## 4000

4061A Semiconductor/Component Test System .....	524
4062B Semiconductor Parametric Test System .....	523
4062C Semiconductor Parametric Test System .....	522
4062C + 24A HP 4062C Operating and Programming Training .....	728
4062UX Semiconductor Process Control System .....	520
4085M Switching Matrix .....	525
4140B pA Meter/DC Voltage Source .....	532
4141B DC Source/Monitor .....	531
4142B Modular DC Source/Monitor .....	528
4145B Semiconductor Parameter Analyzer .....	526
4191A RF Impedance Analyzer .....	306
4192A LF Impedance Analyzer .....	304
4193A Vector Impedance Meter .....	307
4194A Impedance/Gain - Phase Analyzer .....	302
4195A Network/Spectrum Analyzer .....	232
4261A Digital LCR Meter .....	318
4262A Digital LCR Meter .....	318
4274A Multifrequency LCR Meter .....	312
4275A Multifrequency LCR Meter .....	312
4276A LCZ Meter .....	316
4277A LCZ Meter .....	316
4278A 1 kHz/1 MHz Capacitance Meter .....	314
4279A 1 MHz C-V Meter .....	317
4280A 1 MHz C Meter/C-V Plotter .....	534
4284A Precision LCR Meter .....	308
4285A Precision LCR Meter .....	308
4328A Milliohmeter .....	320
4329A High Resistance Meter .....	320
4342A Q Meter .....	319
4440B Decade Capacitor .....	321
4925B Bit Error Rate Test Set .....	573
4934A Transmission Impairment Measuring Set .....	572
4935A Transmission Impairment Measuring Set .....	572
4935S Data Transmission Test System .....	572
4936A Transmission Impairment Measuring Set .....	572
4945A Transmission Impairment Measuring Set .....	571
4947A Transmission Impairment Measuring Set .....	571
4948A In-service Transmission Impairment Measuring Set .....	571
4951C Protocol Analyzer .....	559
4952A Protocol Analyzer .....	559
4954A Protocol Analyzer .....	560-561
<b>4954AX X.25 WAN Protocol Analyzer</b> .....	560-561
<b>4954I ISDN WAN Protocol Analyzer</b> .....	560-561
4972A LAN Protocol Analyzer .....	564

4974A MAP Protocol Analysis Software/Hardware .....	560-561
4974S System Reference for MAP Protocol Analyzer .....	560
4974S System Reference for MAP Protocol Analyzer .....	561
4990S LanProbe Distributed Analysis System .....	565
4991A LanProbe .....	565
4992A NodeLocator .....	566

## 5000

5005B Signature Multimeter .....	294
5006A Signature Analyzer .....	296
5011T Logic Troubleshooting Kit .....	299
5021A Logic Troubleshooting Kit .....	299
5022A Logic Troubleshooting Kit .....	299
5023A Logic Troubleshooting Kit .....	299
5024A Logic Troubleshooting Kit .....	299
5061B Cesium Beam Frequency Standard .....	508
5065A Rubidium Frequency Standard .....	509
5087A Distribution Amplifier .....	512
5089A Standby Power Supply .....	513
5180A Waveform Recorder .....	79
5180S Waveform Measurement System .....	79
5180T,U Precision Digitizing Oscilloscopes .....	79
5182A Waveform Recorder/Generator .....	80
5182S Waveform Generation System .....	81
5183A Waveform Recorder .....	78
5314A Universal Counter .....	143
5315A Universal Counter .....	140-142
5316B Universal Counter .....	140-142
5328B Universal Counter .....	139
5334B Universal Counter .....	134-135
5335A Universal Counter .....	136-138
5340A Microwave Frequency Counter .....	123
5342A Microwave Frequency Counter .....	121
5343A Microwave Frequency Counter .....	121
5345A Electronic Counter .....	127, 132
5347A Counter/Power Meter .....	118
5348A Counter/Power Meter .....	118
5350B Microwave Frequency Counter .....	115
5351B Microwave Frequency Counter .....	115
5352B Microwave Frequency Counter .....	115
5355A Automatic Frequency Converter .....	127
5356A, B, C, D Frequency Converter Heads .....	127
5359A Time Synthesizer .....	457
<b>5361B 20/26.5/40 GHz Pulse/CW Microwave Counter</b> .....	124
5361B 20/26.5/40 GHz Pulse/CW Microwave Counter .....	125-126
5364A Microwave Mixer/Detector .....	109, 111
5370B Universal Time Interval Counter .....	112
5371A Frequency and Time Interval Analyzer .....	106
5372A Frequency and Time Interval Analyzer .....	106
5384A Frequency Counter .....	130
5385A Frequency Counter .....	130
5386A Frequency Counter .....	130
5501A Laser Transducer System .....	366-367
5507B Laser Position Transducer Electronics .....	366-367
5508A Measurement Display .....	369
5517A Laser Head (400 mm/sec) .....	366
5517B Laser Head (500 mm/Sec) .....	366
<b>5517C Laser Head (700 mm/S)</b> .....	366
5518A Laser Head .....	369
<b>5527B Laser Position Transducer System</b> .....	366
5527B Laser Position Transducer System .....	367-368
5528A Laser Measurement System .....	366, 369
5890 Series II Gas Chromatograph .....	669
5921A Atomic Emission Detector .....	669

# MODEL NUMBER INDEX

New product listings are printed in bold face type

5965B Infrared Detector .....	669
5970B Mass Selective Detector .....	669
5971A Mass Selective Detector .....	669
5988A GC/MS System .....	669
5988A LC/MS System .....	669
5989A GC/MS System .....	669

## 6000

6002A Autoranging DC Power Supply .....	490
6010A 1000 Watt Autoranging Power Supply .....	494
6011A 1000 Watt Autoranging Power Supply .....	494
6012B 1000 Watt Autoranging Power Supply .....	494
6015A 1000 Watt Autoranging Power Supply .....	494
6023A 200 Watt Autoranging Power Supply .....	494
6024A 200 Watt Autoranging DC Power Supply .....	494
6030A 1000 Watt Autoranging System Power Supply .....	486
6031A 1000 Watt Autoranging System Power Supply .....	486
6032A 1000 Watt Autoranging System Power Supply .....	486
6033A 200 Watt Autoranging System Power Supply .....	486
6035A 1000 Watt Autoranging System Power Supply .....	486
6038A 200 Watt Autoranging System Power Supply .....	486
6050A Electronic Load Mainframe .....	466, 468-469
6051A Electronic Load Mainframe .....	466, 468-469
6060A Electronic Load .....	466-469
6063A Electronic Load .....	466-469
6114A & 6115A Precision DC Power Supplies .....	504
6177C Precision DC Current Source .....	505
6181C Precision DC Current Source .....	505
6186C Precision DC Current Source .....	505
6200B-6209B DC Power Supplies .....	500, 502
6212C-6218C DC Power Supplies .....	500, 502
6227B Dual Tracking DC Power Supply .....	492
6228B Dual Tracking DC Power Supply .....	492
6234A Dual Output Power Supply .....	500, 502
6235A Triple Output Power Supply .....	501
6236B Triple Output DC Power Supply .....	501
6237B Triple Output DC Power Supply .....	501
6253A Dual Output DC Power Supply .....	492
6255A Dual Output DC Power Supply .....	492
6259B DC Power Supply .....	496
6260B DC Power Supply .....	496
6261B DC Power Supply .....	496
6263B DC Power Supply .....	496
6264B DC Power Supply .....	496
6266B DC Power Supply .....	496
6267B DC Power Supply .....	496
6268B DC Power Supply .....	496
6269B DC Power Supply .....	496
6274B DC Power Supply .....	496
6281A DC Power Supply .....	492
6282A DC Power Supply .....	492
6284A DC Power Supply .....	492
6286A DC Power Supply .....	492
6289A DC Power Supply .....	492
6291A DC Power Supply .....	492
6294A DC Power Supply .....	492
6296A DC Power Supply .....	492
6299A DC Power Supply .....	492
6434B DC Power Supply .....	498
6448B DC Power Supply .....	498
6453A DC Power Supply .....	498
6456B DC Power Supply .....	498
6459A DC Power Supply .....	498
6464C DC Power Supply .....	498

6466C DC Power Supply .....	498
6469C DC Power Supply .....	498
6472C DC Power Supply .....	498
6475C DC Power Supply .....	498
6477C DC Power Supply .....	498
6479C DC Power Supply .....	498
6483C DC Power Supply .....	498
6621A System Power Supply .....	482
6622A System Power Supply .....	482
6623A System Power Supply .....	482
6624A System Power Supply .....	482
6625A Precision System Power Supply .....	484
6626A Precision System Power Supply .....	484
6627A System Power Supply .....	482
6628A Precision System Power Supply .....	484
6629A Precision System Power Supply .....	484
6632A System Power Supply .....	480
6633A System Power Supply .....	480
6634A System Power Supply .....	480
<b>6651A System Power Supply</b> .....	478-479
<b>6652A System Power Supply</b> .....	478-479
<b>6653A System Power Supply</b> .....	478-479
<b>6654A System Power Supply</b> .....	478-479
<b>6655A System Power Supply</b> .....	478-479
6825A DC Power Supply/Amplifier .....	503
6826A DC Power Supply/Amplifier .....	503
6827A DC Power Supply/Amplifier .....	503
6900 Multiprogrammer I/O .....	614
6942A Multiprogrammer .....	632, 635
6943A Multiprogrammer Extender .....	635
6944A Multiprogrammer .....	632
6944S + 24D Multiprogrammer System User's Course .....	727
6954A Multiprogrammer .....	632-633

## 7000

7060A HP SketchPro Graphics Tablet .....	687
7090A Measurement Plotting System .....	82
7440A ColorPro Plotter .....	694
7475A 6-Pen Graphics Plotter .....	694
7550 Plus 8-Pen Graphics Plotter .....	695
7570A DraftPro Plotter .....	696
7575A DraftPro DXL Plotter .....	696
7576A DraftPro EXL Plotter .....	696
<b>7595B Draftmaster SX Single Sheet Drafting Plotter</b> .....	698-699
<b>7596B Draftmaster RX Drafting Plotter</b> .....	698-699
<b>7599A Draftmaster MX Multiuser Drafting Plotter</b> .....	698
<b>7600 Series Model 250 Monochrome Electrostatic Plotter</b> .....	700
<b>7600 Series Model 255 Monochrome Electrostatic Plotter</b> .....	700
<b>7600 Series Model 355 Color Electrostatic Plotter</b> .....	700
7673A Automatic Injector and Sampler .....	669
7680A Supercritical Fluid Extractor .....	669
7979A 1/2-inch tape drive .....	686
7980A 1/2-inch tape drive .....	686
7980XC High-performance 1/2-inch tape drive .....	686

## 8000

8012B 50 MHz Pulse Generator .....	459
8082A Pulse Generator .....	456
8111A Pulse/Function Generator .....	437
8112A Pulse Generator .....	460
8115A 50-MHz Dual-Channel Pulse Generator .....	461
8116A Pulse/Function Generator .....	440

8118A 100 MBit/s Pulse Pattern Generator	463	8562A Spectrum Analyzer	179
8130A 300-MHz Pulse Generator	452	8563 Spectrum Analyzer	179
8131A 500-MHz Pulse Generator	450	8566B Option 462 Impulse Bandwidths	200
<b>8140A Optical Loss Test Set</b>	327	8566B Spectrum Analyzer	184
8145A Optical Time Domain Reflectometer	328	8567A Spectrum Analyzer	184
8151A Optical Pulse Power Meter	323	8568B Option 462 Impulse Bandwidths	200
<b>8153A Lightwave Multimeter</b>	324-325	8568B Spectrum Analyzer	184
8154B Light Source	330	<b>8573B EMI Receivers</b>	197
8155A Light Source	330	<b>8574B EMI Receivers</b>	197
8157A Optical Attenuator	326	8590B Portable RF Spectrum Analyzer	174-175
8158B Optical Attenuator	326	8591A Spectrum Analyzer	176-177
8160A Programmable Pulse Generator	454-455	8592B Microwave Spectrum Analyzer	174-175
8161A Programmable Pulse Generator	454-455	8593A Spectrum Analyzer	176-177
8165A Programmable Signal Source	442	<b>8594A Spectrum Analyzer</b>	176
8175A Digital Signal Generator	438, 464	<b>8595A Spectrum Analyzer</b>	176
8200 Introductory Training	728	8640B AM/FM Signal Generator	406
8328A/S Transmission Line Test Set	228	8642A/B Synthesized Signal Generators	382
8347A RF Amplifier	424	8644A Synthesized Signal Generator	380
8349B Microwave Amplifier	426	8645A Agile Signal Generator	398
8350 Sweep Oscillator Family	410-411	8656B Synthesized Signal Generator	374
8350B Sweep Oscillator Family	414-423	8657A Synthesized Signal Generator	376
8360 Series Synthesized Sweeper	395, 410-411, 413	8657B Synthesized Signal Generator	378
8444A Option 059 Tracking Generator	188	8662A Synthesized Signal Generator	387
8447 Series Amplifiers	425	8663A Synthesized Signal Generator	387
8447D Broadband Preamplifier	173	8665A Synthesized Signal Generator	390
8447F Option H64	201	8665B Synthesized Signal Generator	390
8449B Microwave Preamplifier	201	8671B Synthesized CW Generator	392
<b>8449B Preamplifier</b>	427	8673B Synthesized Signal Generator	396
8452A Diode Array Detector	668	8673C/D Synthesized Signal Generators	396
8470B Coaxial Crystal Detectors	358	8673G Synthesized CW Generator	393
8471D/E Coaxial Detector	358	8673H Synthesized Signal Generator	394
8472B Coaxial Crystal Detector	358	8683B/D Signal Generators	408
8473 Series Coaxial Detectors	358	8684B/D Signal Generators	408
8474 Series Coaxial Detectors	358-359	8702B Lightwave Component Analyzer	332
8477A Power Meter Calibrator	150	8703A Lightwave Component Analyzer	332
8478B Coaxial Thermistor Mount	151	8719A Network Analyzer	246
8481A/B/D/H Power Sensors	148	8720B Network Analyzer	246
8482A/B/H Power Sensors	148	8721A Directional Bridge	188, 349
8483A Power Sensor	148	<b>8751A Network Analyzer</b>	236
8484A Power Sensor	148	8752A RF Network Analyzer	238
8485A/D Power Sensors	148	8753B + 24A HP 8753A RF Network Analyzer Course	727
8487A/D Power Sensors	148	8753C Network Analyzer	240, 244
8490D 2.4mm Coaxial Fixed Attenuator	350-351	8757C/E Scalar Network Analyzer	219
8491A Coaxial Fixed Attenuator	351	8761 SPDT Coaxial Switch	355-357
8491A/B Coaxial Fixed Attenuators	350	8762 SPDT Coaxial Switch	355-357
8492A Coaxial Fixed Attenuator	350-351	8763 4-Port Coaxial Switch	355-357
8493A/B/C Coaxial Fixed Attenuators	350-351	8764 5-Port Coaxial Switch	355-357
8494A/B/G/H Coaxial Step Attenuators	352-353	8765 SPDT Coaxial Switch	356
8495A/B/D/G/H/K Coaxial Step Attenuators	352-353	8765 SPDT Coaxial Switches	357
8496A/B/G/H Coaxial Step Attenuators	352-353	8766-69 SP - Multi-throw Coaxial Switch	356
8497K Coaxial Step Attenuators	352	8766-9 SPMT Coaxial Switches	357
8498A Coaxial Fixed Attenuator	350-351	8770A Arbitrary Waveform Synthesizer	400
8508A Vector Voltmeter	245	8770S Signal Simulator System	400
8510B + 24D Basic Measurements Using HP 8510 Network Analyzer System	727	8780A Vector Signal Generator	404, 556
<b>8510C Network Analyzer</b>	248	8782A Vector Signal Generator	405, 557
8510C Series Millimeter-Wave Measurement System	250	8791 Model 100 Precision Signal Generator	402-403
8511A Frequency Converter (45 MHz to 26.5 GHz)	249	<b>8791 Model 11 Frequency Agile Signal Simulator</b>	402-403
8511A Frequency Converter	255	8791 Model 200 Radar Simulator	402-403
8511B Frequency Converter (45 MHz to 50 GHz)	249	8791 Model 2000 Advanced Agile Threat Simulator	402-403
8514B S-Parameter Test Set (45 MHz-20 GHz)	249	8900C/D Peak Power Meters	151
8515A S-Parameter Test Set (45 MHz-26.5 GHz)	249	8901A Modulation Analyzer	209
8516A S-Parameter Test Set (45 MHz-40 GHz)	249	8901B Modulation Analyzer	209
8517A S-parameter test set (45 MHz to 50 GHz)	249	8902A Measuring Receiver	211
8560A Spectrum Analyzer	179	8902AT Attenuator Calibration System	213
8561B Spectrum Analyzer	179	8902S Microwave Measurement System	215
		8903B Audio Analyzer	207

# MODEL NUMBER INDEX

New product listings are printed in bold face type

8903E Distortion Analyzer	207
8904A Multifunction Synthesizer	434-436
8953A Transceiver Test Set	338
8954A Transceiver Interface	340
8955A RF Test System	338
8956A System Interface	340
8957S Cellular Radio Test System	338
8970B Noise Figure Meter	345
8970S/U Microwave Noise Figure Measurement Systems	346
8970U Noise Figure Measurement System	347
8971C Noise Figure Test Set	346
8980A Vector Analyzer	206, 556
8981A Vector Modulation Analyzer	206
8990A Peak Power Analyzer	144

## 9000

9000 Series 300 Computers	607
9000 Series 332 Computer	607-608
9000 Series 360 Computer	607-608
9000 Series 375 Computer	608
9000 Series R/332 Controller	607-609
9000 Series V360 Computer	607-608
9144A 1/4-inch cartridge tape drive	686
9145A high performance 1/4-inch cartridge tape drive	686
9211-708 Series Operating Cases	708
9211-710 Series Transit Cases	710, 712
9480 Analog LSI Test System	519

## 10000

10002A 50:1 Voltage Divider Probe	73-74, 76
10020A Resistive Divider Probe Kit	73-74, 76
10024A IC Test Clip	76
10062A Protective Cover	465
10100C 50-ohm BNC Feedthrough	76
10229A Hook Tip Adapter	76
10240B Blocking Capacitor	73-74
10300B Microprocessor Interface	264
10304B Microprocessor Interface	263
10305B Microprocessor Interface	263
10306B Microprocessor Interface	263
10306G Microprocessor Interface	263
10307B Microprocessor Interface	262
<b>10308B Microprocessor Interface</b>	262
<b>10310B Microprocessor Interface</b>	262
10311B Microprocessor Interface	262
10311G Microprocessor Interface	262
10313G Microprocessor Interface	262
<b>10314D Microprocessor Interface</b>	263
10315G Microprocessor Interface	262
10315H Microprocessor Interface	262
10320C Preprocessor	265
10321C Preprocessor	265
10322A Preprocessor	265
10323A Preprocessor	265
10324A Preprocessor	265
10336G Microprocessor Interface	263
10336H Microprocessor Interface	263
<b>10337B Microprocessor Interface</b>	262
<b>10338B Microprocessor Interface</b>	262
<b>10339G Microprocessor Interface</b>	264
10341B Microprocessor Interface	264
10342B Microprocessor Interface	264

10342G Microprocessor Interface	264
10343G Microprocessor Interface	264
10344A Microprocessor Interface	264
10349B Upgrade Kit	291
<b>10391B Preprocessor</b>	265
10430A 10:1 Passive Oscilloscope Probe	72
10431A 10:1 Passive Oscilloscope Probe	72
10432A 10:1 Passive Oscilloscope Probe	72
10433A 10:1 Passive Oscilloscope Probe	72
10434A 10:1 Passive Oscilloscope Probe	72
10435A 10:1 Passive Oscilloscope Probe	72
10436A 10:1 Passive Oscilloscope Probe	72
10437A 50 Ohm Probe	72
10438A 1:1 Passive Oscilloscope Probe	72
10439A 1:1 Passive Oscilloscope Probe	72
10440A 100:1 Passive Oscilloscope Probe	72
<b>10441A 10:1 Passive Oscilloscope Probe</b>	72
10448A Upgrade Kit	291
10449A Upgrade Kit	291
10501A Cable Assembly	707
10502A Cable Assembly	707
10503A Cable Assembly	707
10514A Double-Balanced and Harmonic	350
10529A Logic Comparator	298
10534A Double-Balanced and Harmonic	350
10541A Reference Boards	298
10541B Preprogrammed Reference Boards	298
10595A Board Extender Kit (HP 5345A)	133
10638A Degausser	511
10717A Wavelength Tracker	366-367
10751A Air Sensor	367, 369
10754A Metrology Software	369
10757A Material Temperature Sensor	367, 369
10777A Optical Square	369
10780C Receiver	366-367
10780F Remote Receiver	366
10793A Laser Head Cable	369
10821A Probe Accessory Kit (HP 5363B)	114
10833A/B/C/D HP-IB Cables	579
10834A HP-IB Cable Adapter	579
10842A Extender Board Kit (HP 5342/5343/5344S)	122
10855A Broadband Preamplifier	114
10870A Service Kit (HP 5370B)	113
10871B Service Kit (HP 5180A)	79
10873A Rack Mount Kit	79
10874A Slide Mount Kit	79
10875A/B DMA Cables	79
10895A VME Laser Axis Board	367
10932B Axis Board	367
10936B Servo-Axis Board	367
10941A Prototyping Kit	367
10946C Automatic Compensation Board	367

## 11000

11000-60001 Dual Banana-BNC Cable	707
11000-60001 Dual Banana-Dual Banana Cable	707
11002A Test Leads	99, 707
11003A Test Leads	99, 707
11053A Low Thermal Lug-Lug Jumper Set	99
11058A Low Thermal Banana-Banana Jumper Set	99
11059A Kelvin Probe Set	99
11060A Surface Mount Device Probe Set	99
11062A Kelvin Clip Set	99
11096B High Frequency Probe	99

1174A Low Thermal Lug-Banana Jumper Set .....	99	11726A Support Kit for HP 8673B/C/D .....	397
11340A/B/C HP-IL Cable Assemblies .....	583	11727A Support Kit (For HP 8683/84) .....	408
11500A/B/C/D/E/F Precision Cables .....	707	11729C Carrier Noise Test Set .....	205
11501A Cable Assembly .....	707	11742A Blocking Capacitor .....	350
11509A Fuseholder .....	409	11748A High-Impedance Probe Set (HP 8980/81A) .....	206
11511A Coaxial Short .....	361	11752C/D/E Coaxial Connector Gage Kits .....	350
11512A Coaxial Short .....	361	11757A Multipath Fading Simulator .....	555
11515A Waveguide Adapter .....	365	11758T Digital Radio Test System .....	557
11516A Waveguide Adapter .....	365	11760S-E01 Automatic Power Sensor Calibration System .....	148
11524A APC-7 to N (female) Adapter .....	707	11761-6A Adapter Cables for HP 11713A .....	355
11525A APC-7 to N (male) Adapter .....	707	11764 A-D Interconnect Cable (for HP 84900 Attenuators) .....	354
11533A APC-7 to SMA (male) Adapter .....	707	11776A Waveform Generation Software .....	400
11534A APC-7 to SMA (female) Adapter .....	707	11776A + 24D Waveform Generation Language User's Course ..	727
11536A Probe Tee for HP 8508A .....	245	11792A Sensor Module .....	215
11540A Waveguide Stand .....	364	11793A Microwave Converter .....	215
11545A-11548A Waveguide Holders .....	364	11794A Software Pac for HP 8902S .....	215
11549A Power Splitter for HP 8508A .....	245	11798A Software Application Pac for NMT Cellular Radio Test ..	339
11565A Coaxial Short .....	361	11799A Signaling Unit .....	340
11566A Air Line Extension .....	350	11801A/B/C On-Site Service Kits for HP 8642A/B .....	383
11567A Air Line Extension .....	350	11804A Accessory Kit for HP 8957S .....	338
11570A Accessory Kit for HP 8508A .....	245	11805A Software Application Pac for Transceiver Test .....	339
11581A Attenuator Set .....	350-351	11806B Attenuator Test Software for HP 8902AT, HP 8902S ..	213
11582A Attenuator Set .....	350-351	11808A Signal Generator Performance Test Software for HP	
11583A/C Attenuator Sets .....	350-351	8902SG, HP 8902S 8902SG Signal Generator Test System ..	214
11590B Bias Network .....	251	11823A/B Attenuator Accessory Kits .....	213
11600B Transistor Fixture .....	244	11823C SWR Accessory Kit for HP 8902AT, HP 8902S .....	213
11602B Transistor Fixture .....	244	11836A 0.3 GMSK Modulation Measurement Software .....	341
11608A Transistor Fixture .....	251	11845A 2-GHz Retrofit Kit for HP 8645A .....	398
11612A/B Bias Network .....	251	<b>11847A <math>\pi/4</math> DQPSK Modulation</b> .....	342
11613B Calibrator for HP 8756A, 8757A .....	224	11848A Phase Noise Interface .....	204
11614A Firmware Enhancement for HP 8757A .....	223	11850C/D Power Splitters .....	243
11635A Bias Decoupling Network .....	251	11850C/D Three-Way Power Splitters .....	244
11636A/B Power Dividers .....	224, 349	11851B RF Cable Kit .....	243-244
11644A Series Calibration Kits .....	250	11852B 50-75 $\Omega$ Minimum Loss Pad .....	243
11644A Series Millimeter-Wave Calibration Kits .....	252	11852B Minimum Loss Pad .....	244
11645A Series Verification Kits .....	250	11853A 50 $\Omega$ Type N Accessory Kit .....	243
11645A series millimeter-wave verification kits .....	252	11853A Type N Accessory Kit .....	244
11652-60001 BNC (m) 50-ohm Termination .....	361	11854A 50 $\Omega$ BNC Accessory Kit .....	243
11664A/D/E Detector for HP 8755, 8756 and 8757 .....	221	11854A BNC Accessory Kit .....	244
11664C Detector Adapter for HP 8755, 8756 and 8757 .....	221	11855A 75 $\Omega$ Type N Accessory Kit .....	243
11665B Modulator for HP 8755, 8756 and 8757 .....	224	11855A Type N Accessory Kit .....	244
11667A/B/C Power Splitters .....	225, 349	11856A 75 $\Omega$ BNC Accessory Kit .....	243
11668A High Pass Filter for HP 8755, 8756, 8757 .....	224	11856A BNC Accessory Kit .....	244
11672A Service Accessory Kit for HP 8660A/C/D .....	386	11857B Test Port Extension Cables .....	244
11678A Low Pass Filter Kit .....	224	11857B/D Test Port Extension Cables for HP 85046A/B .....	243
11679A/B Extension Cables for HP 8755, 8756 and 8757 .....	223	11857D Test Port Extension Cables .....	244
11683A Range Calibrator .....	147	11858A Transistor Fixture Adapter .....	243-244
11684/5/6/8/9A Low Pass Filters .....	224	11867A RF Limiter .....	188
11687A Adapter, 50 to 75 $\Omega$ .....	409	11869A Adapter for HP 86200 Series Sweeper Plug-ins .....	416
11690A Frequency Doubler .....	409	11871A/B/C Fiber Cables .....	333
11691D Coaxial Directional Coupler .....	362	11876A Upgrade Kit .....	332
11692D Coaxial Dual Directional Coupler .....	362	11882A Upgrade Kit for HP 8753A .....	241
11693A Microwave Limiter .....	188	11883A Harmonic Measurement Upgrade Kit .....	241
11694A Matching Transformer .....	188	11884A 6 GHz Receiver Upgrade Kit .....	241
11707A Test Plug-in .....	386	11885A 3 GHz Frequency Upgrade Kit .....	239
11708A Attenuator (30dB, 50 MHz) .....	148	11886A Interconnect Cable Kit .....	333
11710B Down Converter .....	409	11887A Interconnect Cable Kit .....	333
11713A Attenuator/Switch Driver .....	355	11889A RF Interface Kit .....	332
11714A Service Support Kit (for HP 8662A, 8663A) .....	389	11890A Lightwave Coupler .....	332
11715A AM/FM Test Source .....	210	11891A Lightwave Coupler .....	332
<b>11716 K Waveform Generation Language</b> .....	402	11940A Close-field Probe .....	200
<b>11716 K Waveform Generation Language</b> .....	403	11941A Close-field Probe .....	200
11716A/B Interconnection Kits .....	352	11945A Close-field Probe Set .....	200
11717A Attenuator/Switch Rack Mount Support Kit .....	355	<b>11947A Transient Limiter</b> .....	200
11721A Frequency Doubler .....	409	11949A Designing for EMC Seminar .....	727
11722A Sensor Module .....	212	11949A EMC Design Course .....	200

# MODEL NUMBER INDEX

New product listings are printed in bold face type

<b>11965R Current Probe Kit</b> .....	201	16047A Direct Coupled Test Fixture .....	301
<b>11966 Series Antennas</b> .....	201	16047B Test Fixture with Safety Cover .....	301
<b>11967C Line Impedance Stabilization Network</b> .....	201	16047C Test Fixture for High Frequencies .....	301
<b>11968 Series Turntables</b> .....	201	16047D Direct Coupled Test Fixture .....	301
<b>11968C Antenna Tripod</b> .....	201	16048A Test Leads, BNC .....	301
11970 Series Harmonic Mixers .....	187, 350	16048B Test Leads, RF Miniature .....	301
11974 Series Preselected Millimeter Mixers .....	187	16048C Test Leads, Alligator Clips .....	301
11975A Microwave Amplifier .....	188	16048D Test Leads, BNC (2m) .....	301
11980A Fiber-optic Interferometer .....	335-336	16048E Test Leads, BNC (4m) .....	301
<b>11982A Amplified Lightwave Converter</b> .....	337	16053A Test Leads .....	533
<hr/>			
<b>12000</b>		16054A Connection Selector .....	533
<b>12016A SCSI Interface Card</b> .....	642-643	16055A Test Fixture .....	533
12100A A400 Single-Board Computer .....	642-643	16056A Current Divider .....	533
<hr/>			
<b>14000</b>		16058A Test Fixture .....	529
14513A Rack Kit (for one unit, 3½ in. H) .....	493, 502	16061A Test Fixture .....	301, 318
14515A Rack Kit (for one unit, 5¼ in. H) .....	493	16062A Test Leads .....	301, 318
14521C Rack Kit (for Bench Series) .....	502	16063A Test Leads .....	301, 318
14523A Rack Kit (for two units, 3½ in. H) .....	493, 502	16064A Retrofit Kit for Comparator .....	316
14704A/B/C Multiprogrammer Interface Cables .....	634	16065A External DC Bias Test Fixture .....	301
14753A Computer Aided Test Programming Package .....	634	16066A Test Fixture Adapter .....	521
14753A Computer Aided Test Software .....	632	16067A 24-pin DIP Low Leakage Fixture .....	521
14753R Right to Reproduce CAT Program Pkg .....	634	16068A 48-pin DIP Low Leakage Fixture .....	521
14852A Bias Cable .....	485	16069A Universal Low Leakage Fixture .....	521
<b>14921A Power Supply Calibration Software</b> .....	489	16070A General Purpose DIP Fixture .....	521
<hr/>			
<b>15000</b>		16071A Universal Fixture .....	521
15408A-15411A HP 175A Accessories .....	465	16071B Universal Fixture .....	521
15415A Plus-on Miniprobe .....	465	16072A Personality Board .....	521
15429A Solder-in Receptacles .....	465	16072B Personality Board .....	521
15430A Cable for Master-Slave Operation .....	465	16075A Relay Test Adapter .....	521
15461A ECL Pod .....	465	16076A System Test Module .....	521
15462A TTL/CMOS Pod .....	465	16077A Extension Cable Fixture .....	521
15463A Trisser Pod .....	465	16080A Direct Coupled Test Fixture .....	535
15464A TTL Pod .....	465	16081A Test Leads .....	535
15512A Cable .....	553	16082A Test Leads .....	535
15513A 1m Audio Cable .....	572	16083A Pulse Bias Noise Clipper .....	535
15513A 1m Cable .....	571	16085B Terminal Adapter .....	301
15513A 1m WECO 310 - WECO 310 Cable .....	550	16088A Test Fixture .....	529
15513A Cable .....	553	16091A Coaxial Fixture Set .....	301
15515B Loop Holding Unit .....	553	16092A Spring Clip Fixture .....	301, 307
15518A/B Loop Holding Accessories .....	553	16093A/B Binding Post Fixture .....	301, 307
15567A Ladder Bracket .....	572	16094A Probe Fixture .....	301
15668A Front-panel DDS Clock Cable .....	550	16095A Probe Fixture .....	301, 305
15669A Rear-panel DDS Clock Cable .....	550	16096A 2-Port Component Test Fixture .....	301
15678A 19-inch RackMount .....	572	16099A Test Fixture Adapter .....	301, 307
15709A High Impedance Probe .....	556	16117A Low Noise Test Leads .....	320
15710A Soft-fabric Carrying Case .....	550	16143A Probe Cable .....	320
<hr/>			
<b>16000</b>		16276A Interactive Measurement & Analysis Software .....	530
16005A Probe .....	320	16320B Pin Board .....	521
16006A Probe .....	320	16320C Pin Board .....	521
16007A/B Test Leads .....	320	16334A Test Fixture for Chip Components .....	301
16008A Resistivity Cell .....	320	16355A Relay Test Adapter .....	521
16014A Series Loss Test Adapter .....	319	16356A System Test Module .....	521
16034E Test Fixture for Chip Components .....	301	16370A Test Fixture Adapter .....	521
		16371A 24-pin DIP Low Leakage Fixture .....	521
		16372A 48-pin DIP Low Leakage Fixture .....	521
		16373A 64-pin DIP Low Leakage Fixture .....	521
		16374A Universal Low Leakage Fixture .....	521
		16375A General Purpose DIP Fixture .....	521
		16376A Universal Fixture .....	521
		16376B Universal Fixture .....	521
		16377A Personality Board .....	521
		16377B Personality Board .....	521
		16378B Extension Cable Fixture .....	521
		16380A/C Standard Capacitor Sets .....	321
		16451A Dielectric Test Adapter .....	319
		16451B Dielectric Test Fixture .....	301

16462A Auxiliary Capacitor ..... 319  
 16470A/B/C Reference Inductors ..... 319  
 16500A Logic Analysis System ..... 57, 270  
 16510B State/Timing Analysis Module ..... 272  
 16511B State/Timing Analysis Module ..... 272  
 16515A 1 GHz Timing Card ..... 277  
 16516A 1 GHz Timing Card ..... 277  
 16520A 50 Mb Pattern Generator Master Card ..... 278  
 16521A 50 Mb Pattern Generator Expansion Card ..... 278  
 16530A 400 Msample Digitizing Oscilloscope Card ..... 276  
 16530A Digitizing Oscilloscope ..... 57  
 16531A 400 Msample Digitizing Oscilloscope Card ..... 276  
 16531A Digitizing Oscilloscope ..... 57  
**16540A** 100 MHz State Analyzer ..... 274  
**16541A** 100 MHz State Analyzer ..... 274

**17000**

17090B Measurement Graphics Software ..... 82

**18000**

18107A External Oscillator (HP 2804A) ..... 371  
 18110A Laboratory Probe and Cal Module (HP 2804A) ..... 371  
 18111A Laboratory Probe and Cal Module (HP 2804A) ..... 371  
 18134A Carrying Case ..... 572  
 18160A RS-232/V.35 Interface Pod ..... 559  
 18174A RS-449 Interface Pod ..... 559  
 18176A 23-in Rack Mount Kit ..... 571  
 18177A/G V.35 Interface Pod ..... 559  
 18179A RS-232/V.24 Interface Pod ..... 559  
 18180A RS-232/V.24, RS-449/422A/423A Interface Pod ..... 559  
 18182A 1.5m Cable ..... 571  
 18182A 1.5m WECO 310 - Crocodile Clip Cable ..... 550  
 18182A 1m Audio Cable ..... 572  
 18183A RS-232-C/V.24 Interface ..... 573  
 18184A V.35 Interface ..... 573  
 18185A 115V Power Module ..... 573  
 18190A Soft Vinyl Carrying Case ..... 559  
 18191A 19-in Rack Mount Kit ..... 573  
 18192A Carrying Case ..... 573  
 18192A Soft Vinyl Carrying Case for Interface Pod ..... 559  
 18194A 220V Power Module ..... 573  
 18221A TCP/IP Protocol Interpreter ..... 564  
 18222A TCP/IP Network Performance Analysis ..... 564  
 18223A XNS Protocol Interpreter ..... 564  
 18224A DECnet Protocol Interpreter ..... 564  
 18225A DECnet Performance Analyzer ..... 564  
 18226A ISO Protocol Interpreter ..... 564  
 18228A NFS Protocol Interpreter ..... 564  
 18260A X.21, RS-232 Interface Pod ..... 559  
 18261A SNA Analysis Software ..... 559  
 18263A 3270 Installation and Maintenance Software ..... 559  
 18264A X.25, SNA Link Level Analysis ..... 559  
 18265A DDCMP Analysis ..... 559  
 18266A Enhanced X.25 Analysis ..... 559  
 18267A X.25 Test Library and Emulator ..... 559  
**18268A ISDN Analysis Software** ..... 559  
 18269A G.821 BERT for the HP 4952A ..... 559  
 18273A CCITT#7 Analysis for the HP 4952A ..... 559  
**18280A Basic Rate ISDN Monitor Interface** ..... 559  
**18281A Basic Rate ISDN Monitor and Simulate Interface** ..... 559  
**18282A Primary Rate ISDN Monitor and Simulate Interface** ..... 559  
**18283A Primary Rate ISDN Monitor and Simulate Interface** ..... 559

**18284A Primary Rate ISDN Monitor and Simulate Interface** ..... 559  
 18320A DataCommC Programming Language ..... 560-561  
 18321A X.25 Test Environment and HP 18320A ..... 560-561  
 18322A X.25 Certification Test Suite ..... 560-561  
 18331D SNA, DDCMP, X.25 Analysis ..... 559  
 18332D 3270 Installation and Maintenance Software ..... 559  
 18333D SNA, X.25 Link Level Statistics ..... 559  
 18334D ISDN Analysis Software ..... 559  
 18347A HP 4951C Protocol Analyzer User's Course ..... 727  
 18352A X.21 State Simulator ..... 560-561  
 18355A CCITT#7/CCS7 Analysis ..... 560-561  
 18356A ISDN Basic Interface Channel ..... 560-561  
**18357A ISDN T1 Primary Rate Interface** ..... 560-561  
**18358A ISDN T1 Primary and Basic Rate Interface** ..... 560-561  
**18359A ISDN CEPT Primary Rate Interface** ..... 560-561  
 18360A SNA Emulation Language ..... 560-561  
 18361A 3270 Device Exerciser ..... 560-561  
 18362A LU6.2 Node Exerciser ..... 560-561  
**18366A ISDN CEPT Primary and Basic Rate Interface** ..... 560-561  
 18369A Asynchronous Terminal Emulator ..... 560-561  
 18370A X.25 Network Performance Analyzer ..... 560-561  
 18371A SNA/BSC Network Performance Analysis ..... 560-561  
 18587A Bar Code Identification System ..... 669

**19000**

19395A Headspace Sampler ..... 669

**20000**

22861B ARPA/Berkeley Services for Series 300, Series 800 ..... 728  
 22862A Administration of NFS and Yellow Pages ..... 728  
**22867A Wire Test Instrument** ..... 568-569

**30000**

31112A Introduction to Pascal ..... 727  
 31113A HP Pascal for Advanced and System Programming ..... 727  
 31124A Introduction to Ada/300 DS ..... 727  
 33311 SPDT Coaxial Switch (OEM) ..... 357  
 33312 4-Port Coaxial Switch (OEM) ..... 357  
 33313 5-Port Coaxial Switch (OEM) ..... 357  
 33314 SPDT Coaxial Switch (OEM) ..... 357  
 33320 Series OEM Coaxial Step Attenuators ..... 352-353  
 33324/6/7 Series ..... 354  
 33330B/C/D/E Coaxial Crystal Detectors ..... 358  
 33330D/E OEM Coaxial Detector ..... 359  
 33331D/E Coaxial Detector ..... 358  
 33334 Series Coaxial Detectors ..... 358  
 33334 Series OEM Coaxial Detectors ..... 359  
 33336C Directional Detector ..... 358  
 33340A/B/C/D Coaxial Fixed Attenuator ..... 351  
 33340A/B/C/D OEM Coaxial Attenuators ..... 350  
 33363-66 SP-Multi-throw Coaxial Switch (OEM) ..... 357  
**33449A LaserJet III printer** ..... 691  
**33459A LaserJet IIID printer** ..... 691  
 33471A LaserJet IIP Printer ..... 691  
 34110A Carrying Case ..... 99  
 34111A High Voltage Probe ..... 99  
 34118A Test Lead Kit ..... 91, 99  
 34119A High Voltage Probe ..... 91, 99  
 34300A 40 kV AC/DC High Voltage Probe ..... 99

# MODEL NUMBER INDEX

New product listings are printed in bold face type

34301A RF Detector Probe .....	99
34302A Clamp-on AC/DC Current Probe .....	99
34303A Temperature Probe .....	99
34530T MW Switch Terminal Block for HP 3235A .....	355
34800A & 24D Developing Test Plans using FTM/300 .....	727
35073A HP-UX System Administration for Series 200 .....	728
35129B HP-UX System Administration for Series 500 .....	728
35130B Programming in C Language .....	727
35629A HP 3562A User's Course .....	727
35640S 16 Ch Hdwre Bundle .....	165
35641S 40 Ch MIMO H/w B .....	165
35645S Vibration Control H/w B .....	165
35650 Signal Analyzer Mainframe .....	165
35650A Mainframe .....	165
35651B Signal Analyzer Processing Module .....	165
35652A Signal Analyzer Input Module .....	165
35652B Signal Input Module .....	165
35653A Signal Analyzer Source Module .....	165
35654A Signal Analyzer Processing Module .....	165
35655A Signal Analyzer Input Module .....	165
35656A Programmable DAC .....	165
35658 Signal Processing System .....	165
35660A Dynamic Signal Analyzer .....	158
<b>35665 Dual-Channel Dynamic Signal Analyzer</b> .....	159
35665 Dual-Channel Dynamic Signal Analyzer .....	160
35680A HP Instrument BASIC .....	158
37050S + 24A HP 37050S User and System Manager Course .....	728
37190A HP 37100S Operator and Management Course .....	728
37191A HP 37100S Operator Training .....	728
37204A Multipoint HP-IB Extender .....	581
37204B Multipoint HP-IB Extender .....	581
<b>37701A T1 Tester</b> .....	550
<b>37711A T1/Datacom Test Set</b> .....	573
<b>37721A Digital Transmission Analyzer</b> .....	549
37900B Signaling Test Set .....	567
37900C Signaling Test Set .....	567
<hr/>	
<b>40000</b>	
41420A Source/Monitor Unit .....	528
41421B Source/Monitor Unit .....	528
41422A High Current Source/Monitor Unit .....	528
41424A Voltage Source/Voltage Monitor Unit .....	528
41425A Analog Feedback Unit .....	528
41800A Active Probe .....	235
<b>41802A 1 MΩ Input Adapter</b> .....	237
41941A/B Impedance Probe Kits .....	302
41951A Impedance Test Kit .....	234
41952A/B Transmission/Reflection Test Sets .....	235
42841A Bias Current Source .....	311
42842A/B/C Bias Current Test Fixture .....	311
42843A Bias Current Cable .....	311
42851A Precision Q Adapter .....	311
44200S/L SimPlate Express Fixture Kit .....	546
44201S Express Cassette .....	546
44202S/L SimPlate 3070 Fixture Kit .....	546
44203S/D/L SimPlate Fixture Kit .....	546
44458A/B/R Data Acquisition Manager .....	601
44461A HP-IB Interface .....	583
44462A 8 Channel Multiplexer Assembly .....	583
44463A Extra Connector Block .....	583
44464A Breadboard Assembly .....	583
44465A 8-Bit In, 8-Bit Out Digital I/O Assembly .....	583
44466A Extra Connector Block .....	583
44469A Seven 10:1 Dividers .....	583
44476B Microwave Switch Module for HP 3488A .....	355
44531A HP 3060A/61A/62A User's Course .....	728
44584 + 24A 1/2 day HP 3060 Enhancement Training .....	728
44850A HP 3065 Advanced User's Course .....	728
44851A HP 3065AT User's Course .....	728
44852A HP 3065 Board Test System User's Course .....	728
44853A HP 3065 AT Training .....	728
44990A Express Fixturing System .....	546
45911C Graphics Tablet .....	688
46298 Series Rack Cabinets .....	720
48000 Remote Terminal Unit .....	596
48050 Remote Terminal Unit .....	596
48060 Remote Terminal Unit .....	596
<hr/>	
<b>50000</b>	
50011C HP-IB Instrument Programming .....	727
50015A Data Acquisition and Control Fundamentals .....	727
50698A Programming in FORTRAN 77 .....	727
50710A Programming with HP-UX System Calls .....	727
50722A HP-UX System Administration for Application Users .....	728
50740A,B,C Microwave Fundamentals Course .....	727
50959A Using SRM from BASIC and Pascal .....	728
51409A HP-IB Theory .....	727
51412A HP-IB with MS-DOS® .....	727
51432A HP-UX Fundamentals for General Users .....	727
51433A Shell Programming for General Users .....	727
51434B HP-UX for Programmers .....	727
51435A Advanced HP-UX Tools .....	727
51436B HP-UX System Administration for Series 300 .....	728
51438A SCS and make .....	727
51439A Advanced Editing with VI .....	727
51440A Document Preparation .....	727
51473A Architecture for T & M Software .....	727
51473A Architecture for Test, Measurement Software .....	727
51482A HP-UX System Administration for Series 800 .....	728
51489A HP-UX Basics for Application Users .....	727
51820A Waveform Generation Software .....	81
54001A 1-GHz Miniature Active Probe Pod .....	64
54002A 50Ω BNC Input Pod .....	64
54003A 1-MΩ 10:1 Probe Pod .....	64
54100A 1-GHz Digitizing Oscilloscope .....	64
54100A Digitizing Oscilloscope .....	56
54100D 1-GHz Logic Triggering Digitizing Oscilloscope .....	64
54100D Digitizing Oscilloscope .....	56
54110D 1-GHz Color Digitizing Oscilloscope .....	64
54110D Digitizing Oscilloscope .....	56
<b>54111D 2 GSa/s Digitizing Oscilloscope</b> .....	66
54111D 500-MHz Logic Triggering Digitizing Oscilloscope .....	65
54111D Digitizing Oscilloscope .....	56
54112D 100-MHz, 4-Channel Digitizing Oscilloscope .....	67
54112D Digitizing Oscilloscope .....	56
54120B Digitizing Oscilloscope Mainframe .....	68-71
54121A Four Channel Test Set .....	68-71
54121T 20 GHz Digitizing Oscilloscope .....	68-71
54121T Digitizing Oscilloscope .....	56
54122A Four Channel Test Set .....	68-71
54122T 12.4 GHz Digitizing Oscilloscope .....	68-71
54122T Digitizing Oscilloscope .....	56
54123A Four channel Test Set .....	68-71
54123T 34 GHz Digitizing Oscilloscope .....	68-71
54123T Digitizing Oscilloscope .....	56
<b>54124A Four Channel Test Set</b> .....	68-71
<b>54124T 50 GHz Digitizing Oscilloscope</b> .....	68-71
54124T Digitizing Oscilloscope .....	56



54501A 100 MHz Digitizing Oscilloscope	63
54501A 100 MHz digitizing oscilloscope	58
54501A Digitizing Oscilloscope	57
54502A 400 MSa/s Digitizing Oscilloscope	62
54502A 400 MSa/s digitizing oscilloscope	58
54502A Digitizing Oscilloscope	57
54503A 500 MHz Digitizing Oscilloscope	61
54503A 500 MHz digitizing oscilloscope	58
54503A Digitizing Oscilloscope	57
54504A 200 MSa/s digitizing oscilloscope	58
54504A Digitizing Oscilloscope	57
54504A MSa/s Digitizing Oscilloscope	60
<b>54510A - 1 GSa/s Digitizing Oscilloscope</b>	59
<b>54510A 1 GSa/s digitizing oscilloscope</b>	58
54510A Digitizing Oscilloscope	57
55280A Linear Measurement Kit	369
55280A + 24D Basic Laser Measurement Training	727
55281A Angular Optics Kit	369
55282A Flatness Accessory Kit	369
55283A Straightness Measurement Kit	369
55283A + 24A Advanced Laser Measmnt Sys. Training	727
59306A Relay Actuator	580
59307A Dual VHF Switch	580
59309A HP-IB Digital Clock	580
59401A Bus System Analyzer	579
59501B HP-IB Power Supply Programmer	491, 580
59510A Relay Accessory for Power Supplies	488
59511A Relay Accessory for Power Supplies	488
59991A-K34 Broadband Linear Phase Comparator	511
59992A-J06 Time Interval Calibrator	112
59992A-K70 Rack Mount Adapter Kit (HP 5342A, 5343A)	122

## 60000

60501A Electronic Load	466-469
60502A Electronic Load	466-469
60503A Electronic Load	466-469
60504A Electronic Load	466-469
60505A Electronic Load	466-467
64000 AxCASE microprocessor development environment	648-653
64100A + 24D HP 64000 System Concepts and Measurements	728
64120T HP DesignCenter 64000-UX User's Course	728
64121T HP-UX for HP 64000-UX User's Course	728
64310A + 24D Software Performance Analysis	728
64600S + 24D Timing/Hardware Analysis	728
64620S + 24D State/Software Analysis	728
64700 Series emulators/analyzers	648-653
64810A + 24D Pascal/64000 on 8080/8085	728
64812A + 24D HP 64000/Pascal on Z80	728
64814A + 24D Pascal on 8086/8088	728
64815A + 24F HP 64000/Pascal on 68000	728
64817A + 24F HP 64000 System HOST Pascal	728
69700A-69706A Resistance Output Cards	637
69709A Power Supply Control Card	637
69720A D/A Voltage Converter Card	637
69721A D/A Current Converter Card	637
69730A Relay Output Card	637
69731B Digital Output Card	637
69734A Timebase Card	637
69735A Pulse Train Output/Stepping Motor Control Card	637
69736A Timer/Pacer Card	637
69750A Scan Control/Pacer Card	637
69751A Analog-to-Digital Converter Card	637
69752A 64 Channel FET Scanner Card	637
69753A Temperature Scanner Card	637

69754A 32 Channel Relay Scanner Card	637
69755A 16 Channel FET Scanner Card	637
69759A 500 kHz A/D Converter Card	637
69761A Integrating Digital Multimeter Card	637
69770A Isolated Digital Input Card	637
69771A Digital Input/Analog Comparator Card	637
69774A Universal Counter Card	637
69775A Counter/Totalizer Card	637
69776A Interrupt Card	637
69790B Memory Card	637
69791A/69792A Memory Cards	637
69793A Breadboard Card	637

## 70000

70000 Modular Measurement System	189-195, 603
70001A mainframe	193
70004A color display	193
70100A Power Meter Module	189
70100A Power Meter	145
70100A power meter	193
70138A Vector Voltmeter	245
70138A vector voltmeter	193
70205A graphics display	193
70206A system graphics display	193
70300A RF tracking generator	193
70301A microwave tracking generator	193
70320A synthesized signal generator	193
70322A synthesized signal generator	193
70325A agile signal generator	193
70591A 1/8 width module part kit	193
70592A 2/8 width module part kit	193
70593A 3/8 width module part kit	193
70594A 4/8 width module part kit	193
70595A module development design guides	193
70596A module communication design guides	193
70597A MSIB module interface software	193
70600A preselector	193
70601A preselector	193
<b>70611A Attenuator/Switch Driver</b>	194
70611A MMS Switch/Attenuator Driver	355
<b>70612A 1x6 Matrix</b>	195
70612A MMS Driver	355
<b>70612C 2x5 Matrix</b>	195
<b>70613A 1x6 Matrix</b>	195
<b>70613C 2x6 Matrix</b>	195
70620A preamplifier	193
<b>70620B Preamplifier</b>	427
<b>70621A preamplifier</b>	425
70621A preamplifier	193
70700A digitizer	193
70810A Lightwave Module	336
70900B local oscillator	193
70902A IF section	193
70903A IF section	193
70904A RF section	193
70905A RF section	193
70905B RF section	193
70906A RF section	193
70906B RF section	193
70907B external mixer interface	193
70908A RF section	193
70912A Down Converter Module Page 341	341
71100C Modular Spectrum Analyzer	189-193
71200C Modular Spectrum Analyzer	189-193

# MODEL NUMBER INDEX

New product listings are printed in bold face type

71210C Modular Spectrum Analyzer .....	189-193	<b>81554SM Laser Source Module</b> .....	324-325
71400C Lightwave Signal Analyzer .....	334	82000 IC Evaluation System .....	515-517
71400C Lightwave Signal Analyzers .....	336	82161A Digital Cassette Drive .....	677
<b>71400C Option 850</b> .....	334	82164A HP-IL/RS-232 Interface .....	677
71401C Lightwave Signal Analyzer .....	334, 336	82169A HP-IL/HP-IB Interface .....	677
<b>71601A 1 Gbit/s Error Performance Analyzer</b> .....	552	82207A Serial Interface Kit, NEC Japan Only Opt 1AW Serial Interface Cable Only, NEC Japan Only .....	677
<b>71602A 1 Gbit/s Pattern Generator</b> .....	552	82208A Serial Interface Kit, IBM-compatible Opt 1AW Serial Interface Cable Only, IBM-compatible .....	677
<b>71603A 3 Gbit/s Error Performance Analyzer</b> .....	552	82209A Serial Interface Kit, Apple/Macintosh .....	677
<b>71604A 3 Gbit/s Pattern Generator</b> .....	552	82210A HP 41CV Emulator Card .....	677
74001A HP EE DesignCenter System Administration .....	728	82211-90001 HP Solve Equation Library Application Card Owners Manual, English .....	677
74201A HP Design Capture System Overview .....	728	82211A HP Solve Equation Library Application Card .....	677
74202A HP Design Verification Interface User's Course .....	728	82214A 32-Kbyte Battery-backed RAM Card .....	677
74203A Introduction to HILO Modeling .....	728	82215A 128-Kbyte Battery-backed RAM Card .....	677
74210 HP Design Capture System .....	657	82220A HP 48SX Overlay Kit .....	677
74210 HP Design Capture System—HP Printed Circuit Design System (PCDS) Link, EDIF Netlister .....	659	82221A Soft Case for the HP 48SX .....	677
74210A HP Design Capture System (HP DCS) .....	658	82240B Infrared Printer (110V) .....	677
74230A Design Verification Interface .....	657	82241A Adapter, U.S. (110V) .....	677
74230A HP Design Verification Interface .....	659	82242A Infrared Printer Interface Module .....	677
74230B HILO Logic Simulator .....	657, 659	82300C HP Measurement Coprocessor .....	606
74236A Basic HILO Models .....	657	82302A HP BASIC Self-study Course .....	606
74240B Simulation Data File Comparator .....	657	82314E/15E/19E PC-308 Controllers .....	608
74240B Simulation Datafile Comparator .....	659	82323A HP Measurement Coprocessor Upgrade Kit .....	606
74260A TTL Symbol Library .....	657	82332E/33E PC-312 Controllers .....	608
74260B MOS Symbol Library .....	657	82334E PC-315 Controller .....	608
74260C ECL Symbol Library .....	657	82335A HP-IB Interface and Command Library .....	606
74260D Microproc. Symbol Library .....	657	83036C Directional Detector .....	358
74260E PLD Symbol Library .....	657	83040 Series Modular Microcircuit Package .....	360
74260L HP DCS Symbol Libraries .....	658	83040A Modular Microcircuit Package .....	251
74300A Introduction to HP EGS .....	728	83400A Lightwave Source Module .....	332
74301A PCB Design with HP EGS .....	728	83401A Lightwave Source Module .....	332
74302A Customizing HP EGS .....	728	83402A Lightwave Source Module .....	332
74400A HP Printed Circuit Design System (HP PCDS) .....	658	83403A Lightwave Source Module .....	332
74495A Introduction to HP PCDS .....	728	83404A Lightwave Source Module .....	332
74661A RLC Symbol Library .....	657	83410B Lightwave Receiver Module .....	332
74661B Semicond. Symbol Library .....	657	83411A Lightwave Receiver Module .....	332
74836T HP DesignCenter ME 30 Users Course .....	728	83411B Lightwave Receiver Module .....	332
75000 System 10 Data Acquisition System .....	584	83412A Lightwave Receiver Module .....	332
75000 VXIbus System .....	594-595, 621, 624, 629	83420A Lightwave Test Set .....	333
		83421A Lightwave Source .....	333
		83422A Lightwave Modulator .....	333
		83500 Series RF Plug Ins .....	417
		83500 Series RF Plug-In .....	419
		83500 Series RF Plug-Ins .....	415, 420
		83500 Series RF Plug-ins .....	414, 418, 423
		83500 Series RF plug-ins .....	410-411, 416, 421-422
		83522A 0.01-2.4 GHz RF Plug-in .....	416, 420
		83525A/B 0.01-8.4 GHz RF Plug-ins .....	416, 420
		83540A/B 2-8.4 GHz RF Plug-ins .....	416, 420
		83545A 5.9-12.4 GHz RF Plug-in .....	416, 420
		83550A 8-20 GHz RF Plug-in .....	416, 420
		83554A 26.5-40 GHz Millimeter-Wave Source Module .....	421-422
		83555A 33-50 GHz Millimeter-Wave Source Module .....	421-422
		83556A 40-60 GHz Millimeter-Wave Source Module .....	421-422
		83557A 50-75 GHz Millimeter-Wave Source Module .....	421-422
		83558A 75-110 GHz Millimeter-Wave Source Module .....	421-422
		83570A 18-26.5 GHz RF Plug-in .....	416, 420
		83572C 26.5-40 GHz RF Plug-in .....	416, 420
		83590A 2-20 GHz RF Plug-in .....	417
		83592A/B/C 0.01-20 GHz RF Plug-in .....	417
		83594A 2-26.5 GHz RF Plug-in .....	417
		83595A/C 0.01-26.5 GHz RF Plug-in .....	417
		83596A 2.4-40 GHz RF Plug-In .....	416, 419
		83597A 0.01-40 GHz RF Plug-In .....	416, 419
<b>80000</b>			
81000AS Optical Power Splitter .....	331		
81000BS Optical Power Splitter .....	331		
81010BS Optical Power Splitter .....	331		
81210LI Optical Isolator .....	330		
81220FL Attenuating Lens Adapter .....	331		
81310LI Optical Isolator .....	330		
<b>81400A Optical Sensor</b> .....	327		
<b>81401A Optical Sensor</b> .....	327		
<b>81411A LED Module</b> .....	327		
<b>81412A LED Module</b> .....	327		
<b>81413A LED Module</b> .....	327		
81511A Optical Head, 550 - 950 nm .....	323		
81512A Optical Head, 900 - 1725 nm .....	323		
<b>81520A Optical Head</b> .....	324-325		
<b>81521B Optical Head</b> .....	324-325		
<b>81530A Power Sensor Modules</b> .....	324-325		
<b>81531A Power Sensor Modules</b> .....	324-325		
<b>81532A Power Sensor Modules</b> .....	324-325		
<b>81533A Optical Head Interface Module</b> .....	324-325		
<b>81536A Power Sensor Modules</b> .....	324-325		
<b>81551MM Laser Source Module</b> .....	324-325		
<b>81552SM Laser Source Module</b> .....	324-325		
<b>81553SM Laser Source Module</b> .....	324-325		

**83810A Lightwave Signal Analyzer** ..... 335-336

**84000 Series EMC Measurement Systems** ..... 196

**84100A EMC Design Development Systems** ..... 196

**84110A EMC Pre-production Evaluation System** ..... 196

**84120A EMI Pre-compliance Measurement System** ..... 196

**84130A EMI Commercial Compliance Measurement System** ..... 196

84811A Peak Power Sensor ..... 151

84812A, 84813A, 84814A Peak Power Sensors ..... 144

84904/6/7 Series Coaxial Step Attenuators ..... 354

85014B Active Device Measurements Application Pac ..... 251

85015B System Software for HP 8756S and 8757S ..... 227

85016B Transmission Line Test Software ..... 227

85018A ..... 256

85019A/B Time Domain Upgrade Kit ..... 241

85019C Time Domain Upgrade Kit ..... 239

85020A/B RF Directional Bridges ..... 221

85022A System Cable Kit ..... 223

85023A/B/C/D/F System Verification Kit ..... 223

85024A High Frequency Probe ..... 188

85024A RF Probe ..... 239

85025A/B/D/E AC/DC Detectors ..... 221

85025C Detector Adapter ..... 221

85026A Waveguide Detectors ..... 221

85027A/B/C/D/E Microwave Directional Bridges ..... 221

85028A Directivity Verification Kits ..... 223

85029B 7mm Verification Kit ..... 244

85031B APC-7 Calibration Kit for HP 8753C ..... 243

85031B Calibration Kit ..... 244

85032B 50 Ω Type-N Calibration Kit ..... 244

85032B Type N Calibration Kit ..... 239

85033C 3.5mm Calibration Kit ..... 239, 244

85036B 75 Ω Type-N Calibration Kit ..... 244

85041A Transistor Test Fixture Kit ..... 251

85043B Systems Cabinet ..... 243-244

85044A/B Transmission/Reflection Test Sets ..... 241

85046A/B S-parameter Test Sets for the HP 8753C ..... 242

85047A S-parameter Test SET ..... 244

85047A S-parameter Test Set for the HP 8753C ..... 242

85050B/C/D 7mm Calibration Kits ..... 252

85051B 7mm Verification Kit ..... 252

85052B/C/D 3.5mm Calibration Kits ..... 252

85053B 3.5mm Verification Kit ..... 252

85054B/D Type N Calibration Kit ..... 252

85055A Type N Verification Kit ..... 252

85056B/D 2.4mm Calibration kits ..... 252

85057B 2.4mm verification kit ..... 252

**85070A Dielectric Probe Kit** ..... 254

**85071A Materials Measurement Software** ..... 254

**85075A Probe** ..... 254

85081B Input Module ..... 245

85082A Input Module ..... 245

85089A Grounding Clip ..... 245

85101B + 24D Advanced Programming for HP 8510 Network Analyzer ..... 727

85104A Series Test Set Modules ..... 250

85106B Millimeter-Wave Network Analyzer Subsystem ..... 250

85130 Series test port adapter sets ..... 253

85131 series 3.5mm test port cables ..... 253

85132 series 7mm test port cables ..... 253

85133 series 2.4mm test port cables ..... 253

85134 series 3.5mm test port cables ..... 253

85135 series 7mm test port cables ..... 253

85138A/B 2.4 mm 50\* Terminations ..... 361

85140A/B 2.4mm Short Circuits ..... 361

85141A/B 2.4mm Open Circuits ..... 361

85150A + 24D Discovering the HP Microwave Design System ..... 727

85150B Microwave Design System ..... 661

85160A Measurement Automation Software ..... 244

85161A Measurement Automation Software ..... 248

85162A Measurement Automation Software ..... 247

85165A Resonator Measurement Software ..... 244

**85180A High-frequency Structure Simulator** ..... 661

85200 Series RF plug-ins ..... 410

85301A Antenna Measurement System ..... 255

85310A Distributed Frequency Converter ..... 255

85320A Test Mixer Module ..... 255

85320B Reference Mixer Module ..... 255

85360A Antenna Measurement Software ..... 255

85380A Weatherproof Enclosure ..... 255

85381A Microwave Cable ..... 255

85381B Microwave Cable ..... 255

85381C Microwave Cable ..... 255

85620A Mass Memory Module ..... 183

85629B Test and Adjustment Module ..... 183

85640A Portable Tracking Generator ..... 183, 188

85650A Quasi-Peak Adapter ..... 198

85668A Spectrum Analyzer Operation Course ..... 727

85685A RF Preselector ..... 198

85700A 32 Kbyte RAM Memory Card ..... 183

85700A 32-Kbyte Blank Memory Card ..... 173

85710A Digital Radio Measurements Personality ..... 183

85711A CATV Measurement Personality ..... 173

**85712B EMC Diagnostic Measurement Personality** ..... 173

85712B EMC Measurements Personality Card ..... 199

85713A Digital Radio Measurement Personality ..... 173

85867A EMI Receiver Functions ..... 198

85869A EMI Measurement Software ..... 199

85874A Combined EMI Software ..... 197

85874B Combined EMI Software ..... 197

**85879A Radiated Emissions Measurement Software** ..... 199

85901A Portable AC Power Source ..... 188

85901A Portable ac Power Source ..... 178

86200 Series RF Plug-ins ..... 423

86200 Series RF plug-ins ..... 411, 416

86222A/B 0.01-2.4 GHz RF plug-in ..... 416

86222A/B RF Plug-ins ..... 423

86235A 1.7-4.3 GHz RF plug-in ..... 416

86235A RF Plug-in ..... 423

86240A 2-8.4 GHz RF plug-in ..... 416

86240A/B/C RF Plug-ins ..... 423

86240B 2-8.4 GHz RF plug-in ..... 416

86240C 3.6-8.6 GHz RF plug-in ..... 416

86241A 3.2-6.5 GHz RF Plug-in ..... 423

86241A 3.2-6.5 GHz RF plug-in ..... 416

86242D 5.9-9 GHz RF Plug-in ..... 423

86242D 5.9-9 GHz RF plug-in ..... 416

86245A 5.9-12.4 GHz RF Plug-in ..... 423

86245A 5.9-12.4 GHz RF plug-in ..... 416

86250D 8-12.4 GHz RF Plug-in ..... 423

86250D 8.0-12.4 GHz RF plug-in ..... 416

86251A 7.5-18.6 GHz RF Plug-in ..... 423

86251A 7.5-18.6 GHz RF plug-in ..... 416

86260A 12.4-18 GHz RF Plug-in ..... 423

86260A 12.4-18 GHz RF plug-in ..... 416

86260B 10-15.5 GHz RF Plug-in ..... 423

86260B 10-15.5 GHz RF plug-in ..... 416

86260C 17-22 GHz RF Plug-in ..... 423

86260C 17-22 GHz RF plug-in ..... 416

86290B 2-18.6 GHz RF plug-in ..... 416

86290B/C RF Plug-ins ..... 423

86290C 2-18.6 GHz RF plug-in ..... 416

86388A Upgrade Kit for HP 8753B ..... 241

# MODEL NUMBER INDEX

New product listings are printed in bold face type

86389A/B Solid-State Switch Upgrade Kit .....	242
87300 B/C Directional Couplers .....	362
87301D Directional Coupler .....	362
87310B 90° Hybrid Coupler .....	362
<b>87511A/B S-parameter Test Sets</b> .....	237
<b>87512A/B Transmission/Reflection Test Sets</b> .....	237

## 90000

92208 Series Chairs .....	702
92211 Series Cabinets .....	703
92213 Series Work Stations .....	703
94000 .....	539
98363B+24D HP ME Series 10 Users Course .....	728
98365U+24D Customizing HP ME Series 10 .....	728
98501B Introduction to Workstation BASIC .....	727
98510D Series 200/300 BASIC Operating and Advanced Programming Course .....	727
98511C Series 200/300 Pascal Operating and Advanced Programming Course .....	727
98580C/81C HP 9000 Model 332 Controllers .....	608
98580W/81W HP 9000 Model 360 Controllers .....	608
98880A HP BASIC/UX Programming and Operating .....	727

0960-0054 SMA-Female Short (50 Ohm) .....	361
0960-0055 SMA-Male Short (50 Ohm) .....	361
00012-90015 Real Estate Applications .....	677
00012-90021 Leasing Applications .....	677
00012-90022 Training Guide .....	677
00017-90019 Real Estate, Banking and Leasing .....	677
00017-90020 Business Finance and Accounting .....	677
00017-90021 Marketing and Sales .....	677
00017-90022 Personal Investment and Tax Planning .....	677
00028-90101 Algebra and College Math (HP 28C/S) .....	677
00028-90102 Calculus (HP 28C/S) .....	677
00028-90104 Probability and Statistics (HP 28C/S) .....	677
00028-90105 Vectors and Matrices (HP 28C/S) .....	677
00028-90111 Mathematical Applications (HP 28S) .....	677
00032-90057 Engineering Applications .....	677
00041-15005 Surveying .....	677
00041-15016 Real Estate .....	677
00041-15022 Games .....	677
00041-15049 Math/Statistics .....	677
00041-15055 HP 41 Advantage .....	677
00042-90020 Programming Examples and Techniques .....	677
00042-90021 Electrical Engineering .....	677
00042-90022 Mechanical Engineering .....	677
<b>00048-90003 HP 48SX Owners Manual, English</b> .....	677
05096A SA/SD for Test, Measurement Software .....	727

## A

A1083A IGC 20 .....	684
A1084A VRAM Kit .....	684
A1085A DRAM Kit .....	684
A1086A IGC 10 .....	684
A1087A Extension Module for HP A1086A .....	684
A1303A/05A/07A Model R/332 Controllers .....	608-609

## B

B1155A X Window System Version 11 for Model 825, 835 .....	644
--	-----

B1156A Right to Copy B 1155A .....	644
B1157A X Window System Version 11 for Model 840 .....	644
B1158A Right to Copy B1157A .....	644
B1159A X Window System Version 11 for Model 850, 855 .....	644
B1160A Right to Copy B1159A .....	644
B1161A User Documentation for Series 300 and 800 .....	644
B1162A Programmer Documentation for Series 300 and 800 .....	644
B1621A HP SoftBench, License for HP 9000 Series 300 .....	654
B1623A HP SoftBench, License for HP 9000 Series 800 .....	654
B1625A HP Encapsulator, License for HP 9000 Series 300 .....	654
B1627A HP Encapsulator, License for HP 9000 Series 800 .....	654
B1851A HP SoftBench, License for Domain Series - DN2500, DN3500, .....	654
B1853A HP SoftBench, License for Domain Series - DN10000 .....	654
B1855A HP Encapsulator, License for Domain Series - DN2500, DN3500, .....	654
B1857A HP Encapsulator, License for Domain Series - DN10000 .....	654

## C

C1602A PaintJet XL Color Graphics Printer .....	689
C1613A PaintWriter XL Color Graphics Printer for Macintosh Computers .....	689
C2106A DeskJet 500 Printer .....	690

## D

D1181A/G/W Monochrome Monitor .....	684
D1182A/B VGA Color Monitor .....	684
D1187A 20" Color Display .....	684
D1188A 16" Color Display .....	684
D1421B Vectra QS/20 PC Model 1 .....	683
D1422B Vectra QS/20 PC Model 46 .....	683
D1424B Vectra QS/20 PC Model 47 .....	683
D1461A Vectra QS/16S PC Model 1 .....	683
D1462B Vectra QS/16S PC Model 46 .....	683
D1464B Vectra QS/16S PC Model 47 .....	683
D1481B Vectra QS/16S PC Model 1 .....	683
D1488A Vectra QS/16S PC Model 86 .....	683
D1489A Vectra QS/16S PC Model 87 .....	683
D1491B Vectra QS/20 PC Model 1 .....	683
D1498B Vectra QS/20 PC Model 86 .....	683
D1499B Vectra QS/20 PC Model 87 .....	683
D2021A Vectra RS/25C PC Model 10e .....	683
D2022A Vectra RS/25C PC Model 100e .....	683
D2023A Vectra RS/25C PC Model 150e .....	683
D2024A Vectra RS/25C PC Model 154e .....	683
D2025A Vectra RS/25C PC Model 304e .....	683
<b>D2212A Vectra 486 PC Model 150</b> .....	683
<b>D2220A Vectra 486 PC Model 1</b> .....	683
<b>D2222A Vectra 486 PC Model 330</b> .....	683
<b>D2223A Vectra 486 PC Model 670</b> .....	683
D2300A AXDS/PC .....	644
<b>D2360A Vectra 386/25 PC Model 1</b> .....	683
<b>D2361A Vectra 386/25 PC Model 80</b> .....	683
<b>D2363A Vectra 386/25 PC Model 80</b> .....	683
<b>D2371A Vectra 386/12 PC Model 1</b> .....	683
D2382A Super VGA Board .....	684
D2383A .....	684
<b>D2460A Vectra 286/12 PC Model 1</b> .....	683
<b>D2461A Vectra 286/12 PC Model 26</b> .....	683
<b>D2462A Vectra 286/12 PC Model 27</b> .....	683
<b>D2463A Vectra 286/12 PC Model 46</b> .....	683

**E**

E1300A HP 75000 Series B Mainframe ..... 622, 629  
E1300A VXI Mainframe ..... 594-595  
E1301A HP 75000 Series B Mainframe ..... 629  
E1301A VXI Mainframe ..... 594-595  
**E1323A Microprocessor Interface** ..... 264  
**E1323A VXI Preprocessor for HP Logic Analyzers** ..... 628  
**E1324A RS-232C/422 Data Comm** ..... 622  
E1326A 5 1/2-Digit Multimeter ..... 623  
E1326B 5 1/2-Digit Multimeter ..... 594-595  
E1328A 4-Channel D/A Converter ..... 594-595, 625  
E1330A Quad 8-Bit Digital Input/Output ..... 625  
E1330A Quad 8-bit Digital Input/Output ..... 594-595  
E1332A 4-Channel Counter/Totalizer ..... 585, 594-595  
E1332A 4-Channel Counter/Totalizers ..... 624  
E1333A 3-Channel Universal Counter ..... 624  
E1345A 16-Channel Relay Multiplexer ..... 594-595, 626  
E1346A 48-Channel Relay Multiplexer ..... 594-595  
E1346A 48-Channel Single Ended Relay Multiplexer ..... 626  
E1347A 16-Channel Thermocouple Relay Multiplexer ..... 594-595, 626  
**E1351A 16-Channel FET Multiplexer** ..... 594-595, 627  
**E1352A 32-Channel Single-ended FET Multiplexer** ..... 594-595  
**E1352A 48-Channel Single-Ended FET Multiplexer** ..... 627  
**E1353A 16-Channel Thermocouple FET Multiplexer** ... 594-595, 627  
E1355A 16-Channel Thermocouple Relay Multiplexer ..... 626  
**E1355A 8-Channel Relay Multiplexer** ..... 594-595  
E1356A 16-Channel Thermocouple Relay Multiplexer ..... 626  
**E1356A 8-Channel Relay Multiplexer** ..... 594-595  
**E1357A 8-Channel 120 Ohm Strain Gage Multiplexer** ..... 627  
**E1357A 8-Channel FET Multiplexer** ..... 594-595  
**E1358A 8-Channel 350 Ohm Strain Gage Multiplexer** ..... 627  
**E1358A 8-Channel FET Multiplexer** ..... 594-595  
E1361A 4x4 Matrix Switch ..... 626  
E1364A 16-Channel Form C Switch ..... 594-595, 626  
E1366A 50-Ohm RF Multiplexer (2X4:1) ..... 627  
E1367A 50-Ohm RF Multiplexer (2X4:1) ..... 627  
E1368A 18 GHz Microwave Switch ..... 627  
E1369A Microwave Switch Driver ..... 627  
**E1370A Microwave Switch Driver** ..... 627  
E1400B HP 75000 Series C Mainframe ..... 622  
**E1400T VXI Development Mainframe** ..... 628  
E1403A A/B-size VXI Module Carrier ..... 628

E1405A Command Module ..... 629  
E1410A 6 1/2-Digit Multimeter ..... 623  
E1411A 5 1/2-Digit Multimeter ..... 623  
E1416A Power Meter ..... 145  
**E1420A Universal Counter** ..... 624  
**E1426A 500 MHz Digitizing Oscilloscope** ..... 625  
E1440A 21 MHz Synthesized Function/Sweep Generator ..... 625  
E1460A 64-Channel Relay Multiplexer ..... 626  
E1468A 64-Channel Relay Multiplexer ..... 626  
E1469A 64-Channel Relay Multiplexer ..... 626  
E1472A 50-Ohm RF Multiplexer (6X4:1) ..... 627  
E1473A 50-Ohm RF Multiplexer Expander (6X4:1) ..... 627  
E1480A V/360 Controller (VXI Embedded) ..... 609  
E1480A V/360 Controller ..... 629  
E1501A HP 75000 Series B Mainframe ..... 622  
E2000A Interactive Test Generator for HP BASIC ..... 610-611  
E2001A Instrument Driver Software for HP ITG ..... 610-611  
E2080A LIF Utilities ..... 606  
E21-5061B Flying Clock (Cesium) ..... 508  
E21-5065A Portable Rubidium Time Standard ..... 509  
E2301A Surface Thermocouple Probe ..... 100-101  
E2302A Airflow Thermocouple Probe ..... 100-101  
E2303A Thermocouple Probe Adapter ..... 100-101  
E2304A Handheld Multimeter Carrying Case ..... 100-101  
E2305A Replacement Test Leads ..... 100-101  
E2373A Multimeter ..... 100-101  
E2377A Multimeter ..... 100-101  
**E2400A Microprocessor Interface** ..... 262  
**E2403A Microprocessor Interface** ..... 263  
**E2404A Microprocessor Interface** ..... 262  
**E2405A Microprocessor Interface** ..... 263  
**E2406A Microprocessor Interface** ..... 262  
**E2407A Microprocessor Interface** ..... 264  
**E2409A Microprocessor Interface** ..... 263  
E2413A Microprocessor Interface ..... 262  
**E2414A Microprocessor Interface** ..... 262  
**E2415A Microprocessor Interface** ..... 263  
**E2416A Microprocessor Interface** ..... 263  
**E2417A Microprocessor Interface** ..... 263  
**E2418A Microprocessor Interface** ..... 264  
**E3300A IC-CAP** ..... 536-537  
**E3330A IC-MS Software** ..... 539

# OSCILLOSCOPES & WAVEFORM ANALYZERS

## Digitizing Oscilloscopes

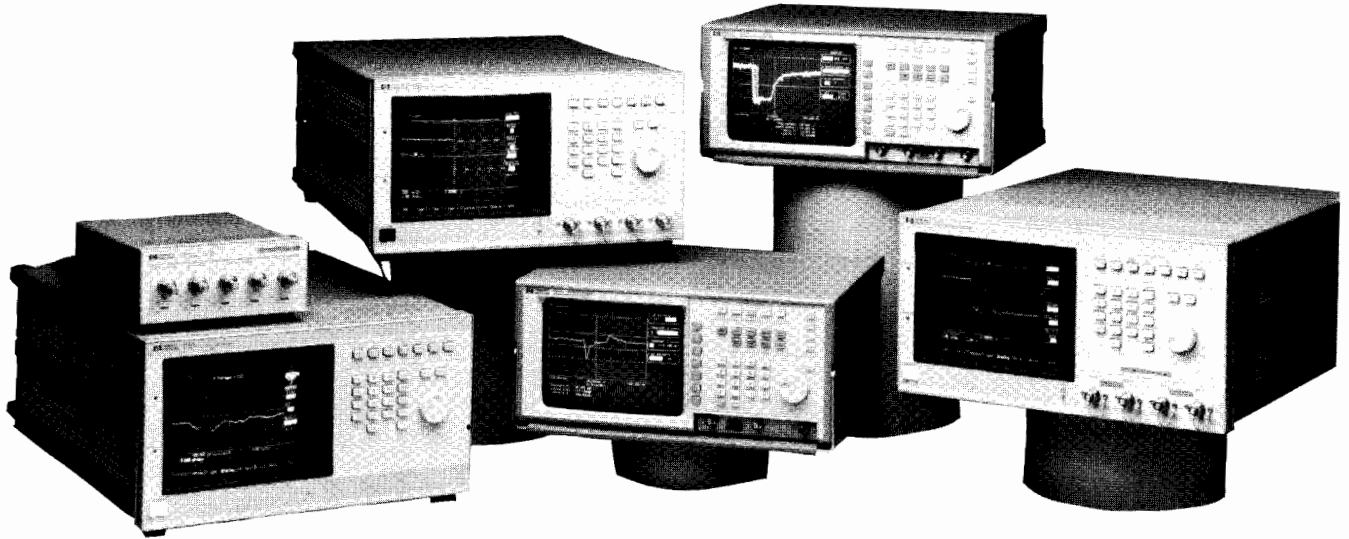

The HP 54100 and HP 54500 series digitizing oscilloscopes . . . combine high bandwidth with high digitizing rates makes these general-purpose oscilloscopes useful for both analog and digital measurements.

### OSCILLOSCOPES Choosing the Right Scope for Your Application

Selecting the right Oscilloscope involves asking whether the instrument can capture and accurately measure your signals. The following information will aid in your selection of the best oscilloscope for your applications.

#### Selection Criteria

**Repetitive or single-Shot:** A single-shot signal is one that occurs only once or infrequently, so you need to acquire all of the information on a single trigger event. Repetitive signals occur over and over, so the signal can be acquired over many trigger events. Repetitive oscilloscopes are typically less expensive than single-shot instruments for the same degree of accuracy.

**Bandwidth:** The bandwidth of an oscilloscope is a critical factor in determining the accuracy to which signals can be measured. The questions to ask are "What is the highest frequency component in my signals?" and "What degree of accuracy do I need for my application?".

The highest frequency component can be estimated using the following formula which compares rise time to bandwidth of signals.

$$\text{frequency} = \frac{0.35}{\text{rise time}}$$

The following graph shows the relationship between the ratio of rise times

$$\frac{\text{signal rise time}}{\text{oscilloscope rise time}}$$

and the measurement error. The measurement error is calculated by using the sum of the squares as shown.

$$\text{Meas } T_r = \sqrt{(\text{Scope } T_r)^2 + (\text{Signal } T_r)^2}$$

As an example, a 250 MHz oscilloscope (rise time 1.4 ns) should accurately and repeatably measure a signal with a 4.2 ns rise time with an error of less than 5.0%.

**Digitizing Rate:** The digitizing rate is primarily of interest in single-shot oscilloscopes. In these instruments the ability to capture and represent a waveform is directly related to the sampling interval, signal conditioning and digital signal processing. All HP single-shot oscilloscopes limit the bandwidth to  $\frac{1}{4}$  the sample rate, and they employ digital signal processing techniques that provide accurate voltage and timing measurements.

### Measurement Error vs. Bandwidth Margin

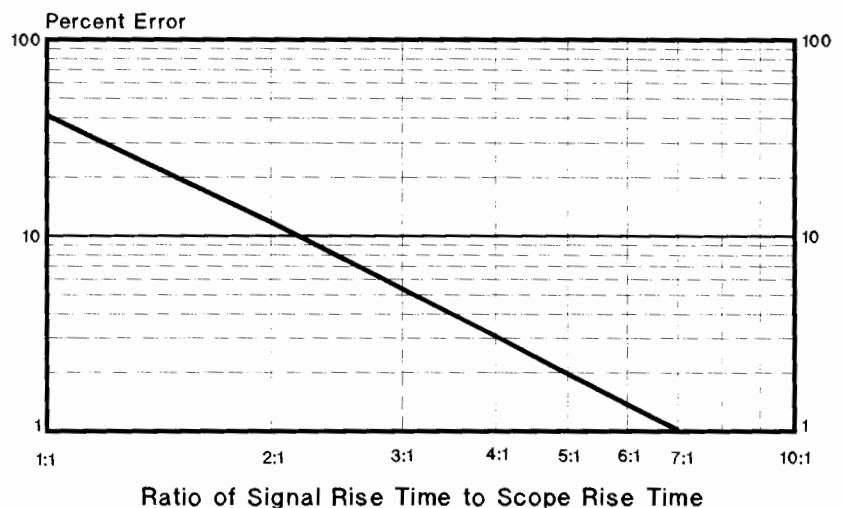

# ELECTRONIC COUNTERS

## Our Highest Performance Universal Systems Counter

### HP 5335A

- A high performance 200 MHz/2 ns Universal Counter
- Built-in automatic rise time, duty cycle, pulse width, slew rate and phase measurements
- Advanced automatic triggering capabilities
- HP-IB plus math and statistics functions standard

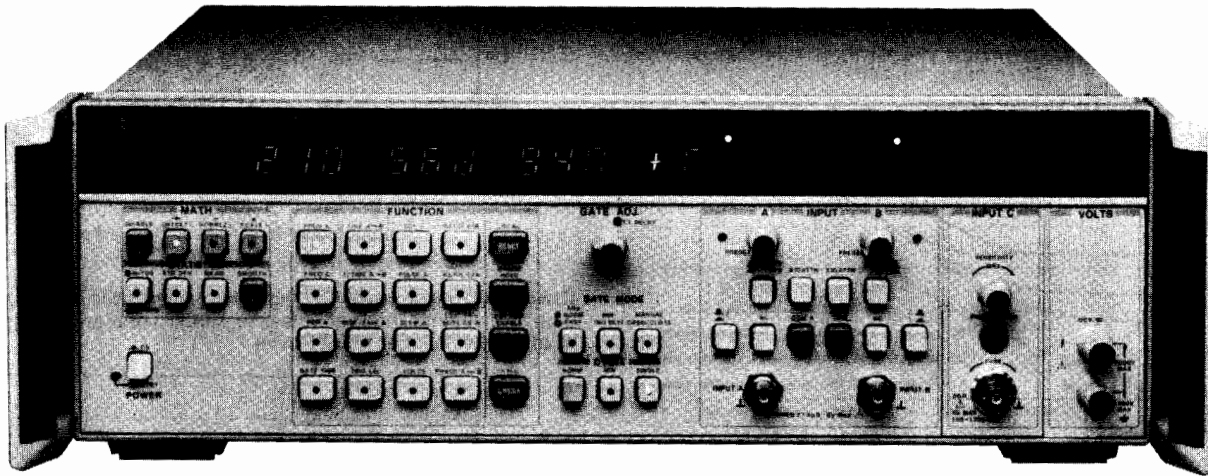

HP 5335A

#### Remarkable Automatic Measurement Power

The HP 5335A is an advanced universal counter with automatic measurement power built in. Designed either for bench or systems applications, the counter has 16 front-panel measurement functions, plus four "phantom" functions, all automatically selected by push button or by HP-IB. These twenty functions, plus greatly expanded arming and triggering capability, make the HP 5335A a most powerful universal counter. In addition, math and statistics features, matched Channel A and B input amplifiers, and HP-IB are all included in the standard unit, making the HP 5335A easily the most advanced universal counter available at its price.

#### Pulse Characterization Measurements

The HP 5335A possesses the expected universal measurements, and does them better than ever before. Beyond the expected measurement set, the HP 5335A has the ability to automatically measure waveform characteristics for various applications. Op amp characterization is one area where a number of measurements are needed to define the amplifier's performance. Using the HP 5335A and a signal source, rise and fall times, output slew rate, and propagation times can be measured with one test set-up. Also, duty cycle can be measured to see the distortion on a square wave through the amplifier due to different rising and falling slew rates. Phase measurements are also push-button selectable and automatically performed by the counter.

#### Complete Triggering Capability

To get good measurement results, a counter must properly trigger on the input signal. The HP 5335A employs both manual and automatic trigger modes to quickly and easily set the right trigger points.

#### Manual Triggering

The counter has a  $\pm 5$  Vdc range to help reduce input attenuator use for most input signals, including TTL.

#### Automatic Triggering

Two auto trigger modes help you trigger automatically. Just press *auto trig* or select auto trig on the HP-IB and the counter automatically selects 10%-90% rise/fall time trigger points, 50% phase trigger points, or the preset value of your choice. Then it tracks the signal's dc offset continuously to stay on the right trigger point. Option 040 allows programmability of trigger levels via HP-IB.

#### Trigger Level DVM

Built into the basic counter. Just press TRG LVL to see both input channel trigger levels displayed.

#### A Full Set of Universal Measurement Functions

In addition to waveform characterization features, the HP 5335A has an extremely wide set of measurement functions covering frequency, time, events and volts. These functions let you characterize signals quicker and more thoroughly than ever before possible.

#### Frequency

Frequency is the most common measurement performed by counters. The HP 5335A measures to 200 MHz in Channel A, 100 MHz in Channel B, and 1.3 GHz in its optional Channel C. Due to the counter's advanced design and reciprocal measurement technique, resolution is a constant 9 digits per second of gate time across its entire measurement range.

#### Time

In a universal counter, a time interval measurement equates to a stopwatch measurement started and stopped by unique events. Precision is dependent on the counter's circuitry.

To ensure precision, the HP 5335A has matched custom input amplifiers to greatly reduce trigger errors that might be produced if the start and stop signals were amplified differently. Further, the counter employs an analog interpolation technique that turns its 10 MHz clock into the equivalent of a 1 GHz time base. The HP 5335A is thus able to resolve single shot time interval measurements to better than 2 nanoseconds (100 ps with averaging). This analog interpolation eliminates the need found in some counters for a phase-modulated (jittered) time base for time interval average measurements.

#### Math and Statistics

Averaging techniques are often used to extend the resolution of a counter. For averaging, the HP 5335A provides sample sizes of  $N = 100$  or  $N = 1,000$ . Best of all, averaging can be employed for all measurements except phase. In addition to mean, and selection of sample size, the counter takes standard deviations of the current measurement for the sample size selected.

Math functions are another built-in feature that provide operator convenience. These functions let you convert the display into direct indications of parameters like flow, speed, pressure, and temperature. Additionally, the counter remembers the offset, scale, and normalize factors for each measurement function.

**Data output**

**Normal operation:** ten readings/second, formatted.  
**High speed mode:** up to 140 readings/second (55 readings/second with Option 700), unformatted.  
**HP-IB interface functions:** SH1, AH1, T5, TE0, L4, LE0, SR1, RL1, PP0, DC1, C0, E2 (see page 578).

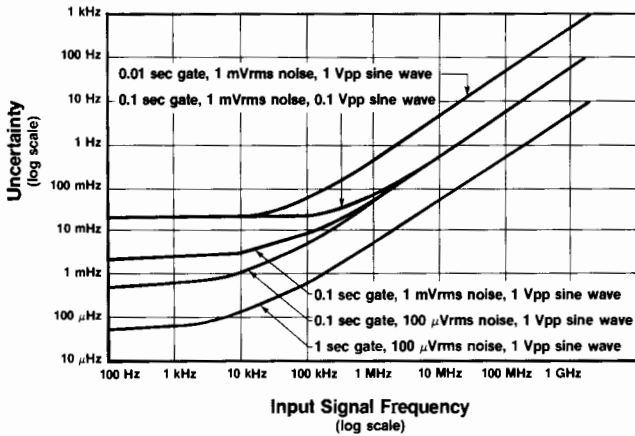

**Graph 1, Frequency Resolution Error:** Noise on the input signal and internal uncertainties affect frequency and period measurements.

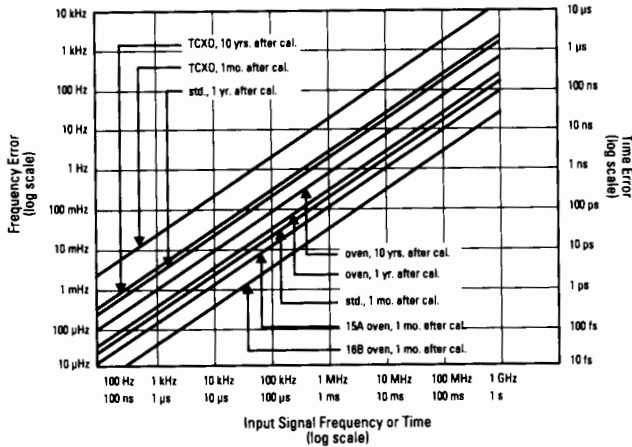

**Graph 2, Time Base Error:** crystal environment and aging affects all measurements.

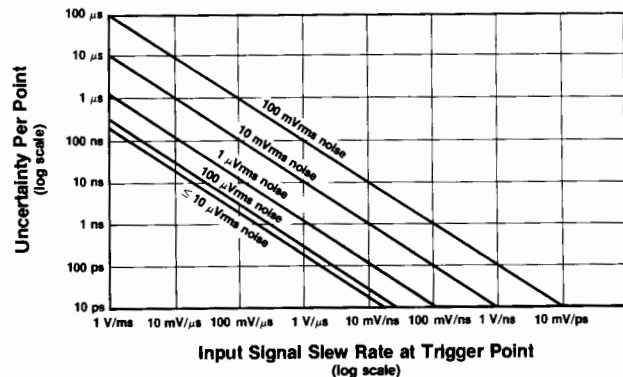

**Graph 3, Input Noise Trigger Error:** Noise on the input signal affects both the start and stop points of all time interval measurements.

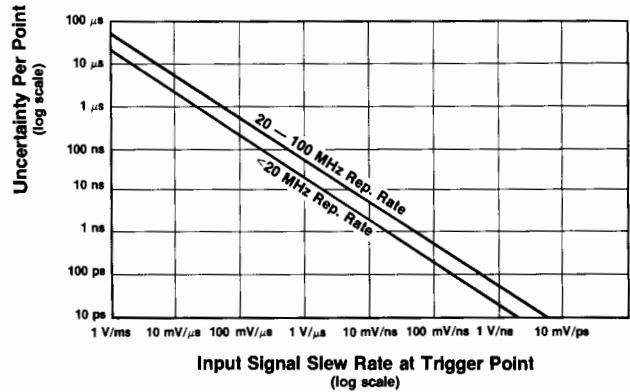

**Graph 4, Trigger Level Timing Error:** Affects the start and stop points of all time-interval measurements. Total error is the larger of the two trigger point errors.

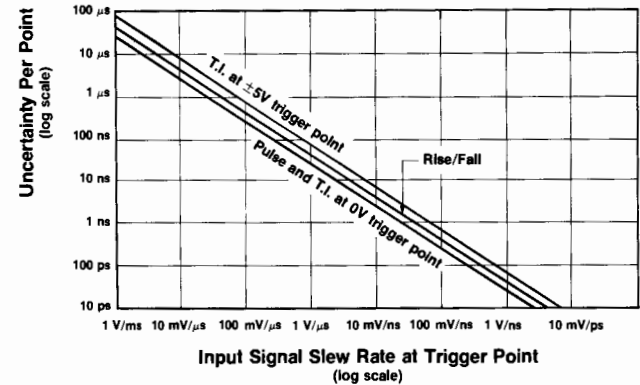

**Graph 5, Trigger Level Setting Error:** Affects both the start and stop points of all time interval measurements.

**HP 5334A**

Contact your local HP sales office for information regarding the HP 5334A Universal Counter.

**Options**

**Option 010 High Stability Time Base (Oven)**

**Frequency:** 10 MHz.  
**Aging Rate:**  $5 \times 10^{-10}$ /day after 24-hour warm up.

**Option 030 1300 MHz C Channel**

**Range:** 90 MHz to 1300 MHz.  
**Sensitivity:** 15 mV rms (-23.5 dBm) sine wave, 90 MHz to 1000 MHz. 75 mV rms (-9.5 dBm) sine wave, 1000 MHz to 1300 MHz.  
**Resolution and accuracy:** same as Frequency A and B.

**Option 700 internal CIIL interface (MATE)**

**Measurement functions provided:**  
 Frequency A, B, and C; Period A, Time Interval A to B, Ratio A/B, Totalize A, Rise/Fall Time A, Pulse Width A, Read Levels A and B (ac/dc voltage and trigger).

**Programmable controls:**

Channel A and B: Trigger Level, Auto Trigger, Coupling, Trigger, Slope, Impedance, Attenuator, Common.  
 External Arm: External Arm Select, Slope.  
 General: Gate Time  
**Measurement data output rate:** 2.5 readings/second.

**Ordering Information**

HP 5334A Universal Counter

HP 5334B Universal Counter

Opt 010 Oven Oscillator

Opt 030 Channel C

Opt 060 Rear Terminals

Channel A,B and ARM in parallel with front inputs.

Option 030 at rear panel only.

Opt 700 Internal MATE programming

Opt W30 Extended repair service. See page 723.

Opt W32 Calibration service. See page 723.

☎ For same-day shipment, call HP DIRECT at 800-538-8787.

**Price**

\$4550

\$2195

+ \$800

+ \$550

+ \$125

+ \$450



# ELECTRONIC COUNTERS

## 100 MHz Universal Counters

HP 5334A and 5334B

- Two matched 100 MHz input channels; optional C Channel to 1.3 GHz
- 9 digits per second resolution from 1 Hz to 1.3 GHz
- 2 ns time interval resolution, 200 ps with averaging
- Automatic rise/fall time, pulse width and ac/dc voltage measurements
- Complete HP-IB programmability standard
- MATE interface optional

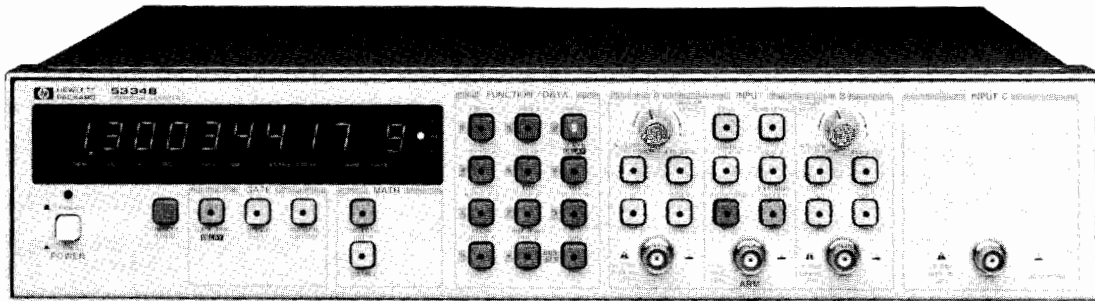

HP 5334B

DESIGNED FOR  
MATE  
SYSTEMS

### HP 5334B Universal Counter

#### Expanded Universal Counter Capability for Bench or System

- Rise/fall time, pulse width measurements at the push of a button.
- Measure the ac/dc voltage of the input signal.
- Offset, normalize, and average measurements for greater usability of results.
- Auto triggering and auto attenuation for user convenience.

#### As well as

- 100 MHz frequency and period measurements with resolution of 9 digits per second of gate time.
- Time interval and time interval delay to 2 ns resolution, 200 ps with averaging.
- Full HP-IB programmability standard with optional rear inputs for system applications. Make up to 140 readings per second.
- 1.3 GHz C Channel, MATE Interface, and High Stability Oven Time Base options.
- External arming/gating for synchronizing measurements to external events.

#### Condensed Specifications

##### Input Characteristics (channels A and B)

###### Range

**dc coupled:** 0 to 100 MHz.

**ac coupled:** 1 M $\Omega$ , 30 Hz to 100 MHz; 50 $\Omega$ , 1 MHz to 100 MHz.

###### Sensitivity

15 mV rms sine wave to 20 MHz, 35 mV rms sine wave to 100 MHz.

100 mV peak-to-peak at a minimum pulse width of 5 ns.

###### Dynamic range (X1)

45 mV to 5 V peak-to-peak, to 20 MHz.

100 mV to 2.5 V peak-to-peak, to 100 MHz.

###### Trigger level range

**Manual (auto trigger off):** continuously adjustable over  $\pm 5.1$  V ( $\times$  ATTN), displayed in 20 mV steps ( $\times$  ATTN).

**Preset:** 0V NOMINAL in Sensitivity Mode.

###### Auto trigger

**dc coupled:** 100 Hz to 100 MHz.

**ac coupled:** 1 M $\Omega$ , 100 Hz to 100 MHz; 50  $\Omega$ , 1 MHz to 100 MHz.

**Trigger slope:** independent selection of + or - slope.

**Impedance:** 1 M $\Omega$  or 50  $\Omega$ , NOMINAL, switch selectable.

###### Attenuator

**Manual:**  $\times 1$  or  $\times 10$  NOMINAL, switch selectable.

**Auto:** attenuator automatically switched when in auto trigger.

**Low pass filter:** 100 kHz NOMINAL, Channel A, switchable.

###### External arm

**Sensitivity:** 500 mV peak-to-peak at Min. pulse width of 50 ns.

**Signal operating range:** -5 V dc to +5 V dc.

**Slope:** independent selection of START and STOP ARM slopes: +, -, or OFF.

##### Frequency A and Frequency B

**Range:** .001 Hz to 100 MHz.

**Resolution:** See graph 1.

**Accuracy:**  $\pm$  Resolution  $\pm$  Time Base Error (Graph 2).

##### Period A

**Range:** 10 ns to 10<sup>3</sup> s (single gate), 10 s (100 GATE AVERAGE)

**Resolution, accuracy:**  $\Delta$ FREQ [PER]/FREQ (Graph 1 and 2)

##### Time interval A to B

**Range:** -1 ns to 10<sup>3</sup> (single shot), 10 s (100 GATE AVERAGE).

**LSD:** 1 ns (100 ps using 100 GATE AVERAGE).

**Resolution:**  $\pm$  LSD  $\pm$  noise trigger error (graph 3)  $\pm$  1 ns rms.

**Accuracy:**  $\pm$  Resolution  $\pm$  time base error (graph 2)  $\pm$  trig level timing error (Graph 4)  $\pm$  trig level setting error (graph 5)  $\pm$  2 ns.

##### Time interval delay

Selectable delay can be inserted between START and STOP of Time Interval A to B. Inputs during delay are ignored. Delay Range is 1 ms to 99.999 s.

##### Ratio A/B

**Range:** .001 Hz to 100 MHz both channels.

**LSD:**  $4 \times$  RATIO/[FREQ A  $\times$  GATE TIME].

**Resolution and accuracy:**  $\pm$  LSD  $\pm$  [B Trig Error (Graph 3)/GATE TIME].

##### Totalize

**Range:** 0 to 10<sup>12</sup> -1.

**Resolution and accuracy:** 1 count of input signal.

##### Pulse width A

**Range:** 5 ns to 10 ms.

**LSD, resolution, accuracy:** same as time interval A to B except  $\pm$  2 ns in Accuracy deleted.

##### Rise/fall time A

**Range:** 30 ns to 10 ms.

**Minimum amplitude:** 500 mV peak-to-peak.

**Dynamic range:** 500 mV to 40 V peak-to-peak.

**LSD, resolution, accuracy:** same as time interval A to B.

##### ac/dc voltage

Max. and min. peaks or dc level of Channel A or Channel B input are displayed.

**Frequency range:** dc, 100 Hz to 20 MHz.

**Dynamic range:** 0-40 V peak-to-peak;  $\pm 51$  Vdc.

**Resolution:**  $\times 1$ : 20 mV  $\times 10$ : 200 mV

##### Time base

**Frequency:** 10 MHz.

**Aging rate:**  $< 3 \times 10^{-7}$  per month.

##### Math

**Display =** (Measurement/Normalize) + Offset.

**Entry range:**  $\pm 1 \times 10^{-10}$  to  $\pm 9.9999999999 \times 10^9$ .

**Single cycle:** one measurement per push of RESET.

**100 gate average:** 100 measurements accumulated and average value displayed. Adds one digit of resolution to measurements and reduces resolution error by 10.

##### Hewlett-Packard Interface Bus

**Programmable controls:** all front-panel controls and functions, except power on/stby switch.

**Trigger level:** set Channel A or B in 20 mV steps ( $\times$  ATTN).

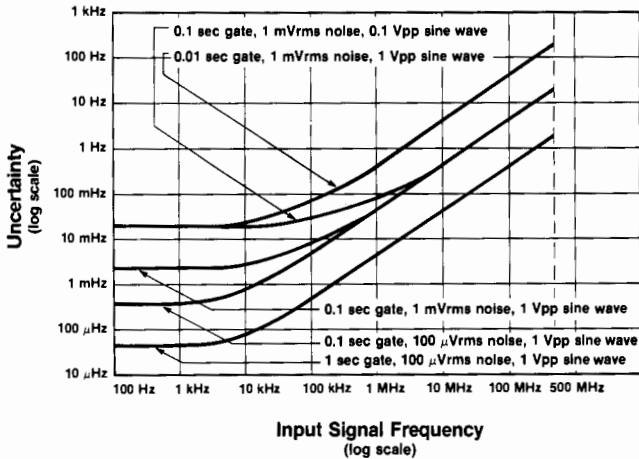

Graph 1, Frequency Resolution Error: Noise on the input signal and internal uncertainties affect Frequency and Period measurements. Longer gate times will reduce this error. (For Period, invert and find the  $\Delta F/F$ , then multiply by the Period. This yields Period Uncertainty ( $\Delta P$ ).

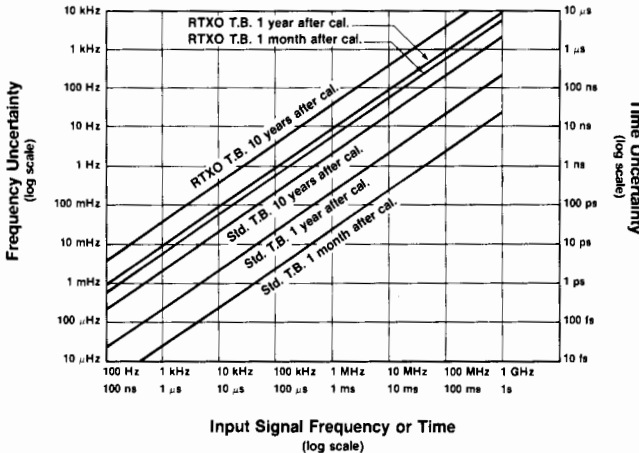

Graph 2, Time-Base Error: Environment and aging of the crystal affects all measurements. Frequent calibration and a better time base will reduce this error.

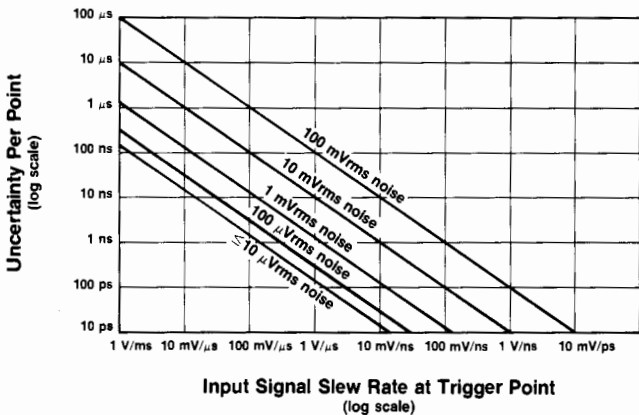

Graph 3, Input Noise Trigger Error: Noise on the input signal affects both the Start and Stop points of all time interval measurements. Averaging will reduce this error.

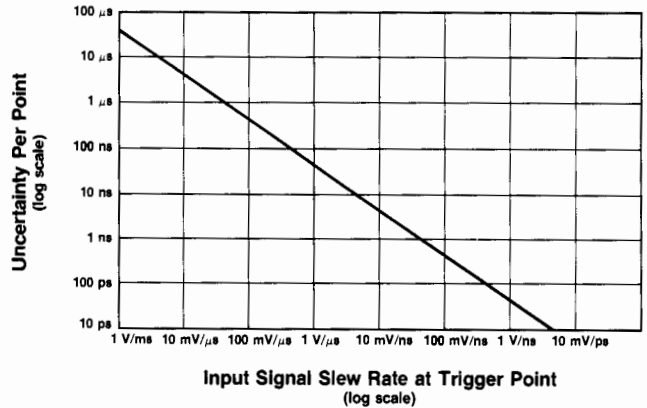

Graph 4, Trigger Level Timing Error: Affects the Start and Stop points, total error is the larger of the two. Input calibration will reduce this error.

**Time Base (cont.)**

**External frequency standard input:** input voltage  $>1.0$  V rms into  $1\text{ k}\Omega$  required from source of 1, 2, 2.5, 5 or 10 MHz  $\pm 5 \times 10^{-8}$  ( $\pm 5 \times 10^{-6}$  for option 001).

**Frequency standard output:**  $>1$  V rms into  $50\ \Omega$  at 10.0 MHz sine wave.

**General**

**Display:** 11-digit LED display and sign.

**Gate time:** 1000 s to 100 ns in decade steps;  $<50$  ns in MIN position.

**Measurement speed**

Mode of Operation	Readings per Second
Normal Operation (Max sample rate)	10
Externally armed	500
Externally gated	500
Computer dump	9,000

**Overflow:** asterisk is illuminated when display is overflowed.

**Sample rate:** continuously variable from  $<0.1$  s to  $>5$  s with front-panel control. In HOLD position the last reading is maintained until the counter is reset.

**External arm input:** counter can be armed by a  $-1.0$  V signal applied to the rear panel  $50\ \Omega$  input.

**External gate input:** same conditions as for EXT ARM.

**Gate output:**  $>1$  V into  $50\ \Omega$ .

**Operating temperature:**  $0^\circ\text{C}$  to  $55^\circ\text{C}$ .

**Power requirements:** 100/120/220/240 V rms  $+5\%$   $-10\%$  48 to 66 Hz, maximum power 250 VA.

**Weight:** 17 kg (37 lb).

**Size:** 132.6H x 425W x 495 mmD (5.22" x 16.75" x 19.5").

**Ordering Information**

HP 5345A* Plug-In Counter	\$14,500
Opt 011 HP-IB includes remote programming	+ \$1,500
Opt 012 HP-IB similar to Opt 011, but also includes slope and trigger level controls	+ \$1,600
Opt 908 Rack Flange Kit, HP 5060-8740	+ \$65
HP 10595A Board Extender Kit: For troubleshooting	\$1,100

\*For same day shipment, call HP DIRECT at 800-538-8787.

\*See page 127 for Microwave extensions.

# ELECTRONIC COUNTERS

## Our Fastest Universal Systems Counter

### HP 5345A

- 500 MHz Direct Count, Conversion Plug-Ins to 110 GHz
- 2 ns Single Shot Resolution, 2 ps Averaged
- 25 mV Sensitivity to 500 MHz
- Up to 9000 readings/second over HP-IB

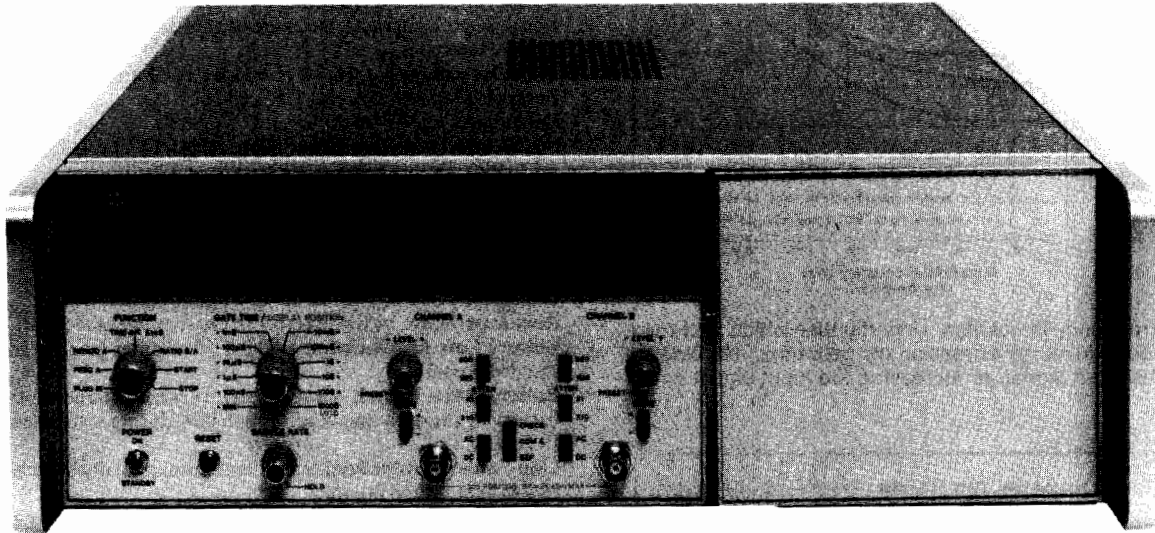

HP 5345A



## HP 5345A Electronic Counter

### Versatile, High-Speed Measurement Power

- High resolution pulsed Frequency measurements and pulse profiling to 110 GHz with the HP 5355A and HP 5356A/B/C/D.
- Rapid 2 ns resolution Time Interval measurements for jitter characterization.
- High throughput Frequency, Period, Ratio, Totalize, and Scale measurements to 500 MHz.

### HP 5345A Condensed Specifications

#### Input channels A and B

**Range:** 0 to 500 MHz dc coupled 50  $\Omega$  and 1 M $\Omega$ ; 4 MHz to 500 MHz ac coupled, 50  $\Omega$ ; 200 Hz to 500 MHz ac coupled, 1 M $\Omega$ .

**Impedance:** selectable, 1 M $\Omega$  shunted by less than 45 pF or 50  $\Omega$  (nominal).

**Sensitivity (X1):** 50 $\Omega$ , 25 mV rms sine wave and 75 mV p-p pulse. 1M $\Omega$ , 25 mV rms sine wave and 75mV p-p pulse to 300 MHz; 50 mV rms sine wave and 150 mV p-p pulse to 500 MHz.

**Trigger level:** adjustable over  $\pm 2.0$  V dc.

**Output:** rear-panel BNC connectors bring out CHAN A TRIG LEVEL and CHAN B TRIG LEVEL for convenient DVM monitoring.

#### Common Input

**Range:** ac coupled 50  $\Omega$ , 4 MHz to 400 MHz; ac coupled 1 M $\Omega$ , 300 Hz to 400 MHz; dc coupled, 0 to 400 MHz.

**Impedance:** 50  $\Omega$  remains 50  $\Omega$ ; 1 M $\Omega$  becomes 500 k $\Omega$  shunted by <80 pF.

**Sensitivity (X1):** 50  $\Omega$ , 50 mV rms sine wave and 150 mV p-p pulse. 1M $\Omega$ , 25 mV rms sine wave and 75 mV p-p pulse to 50 MHz; 75 mV rms sine wave and 150 mV p-p pulse to 200 MHz; 120 mV rms sine wave and 360 mV p-p pulse to 400 MHz.

#### Frequency A

**Range:** 0.00005 Hz to 500 MHz.

**Resolution:** See Graph 1.

**Accuracy:**  $\pm$  Resolution  $\pm$  Time-Base Error (Graph 2).

#### Period A

**Range:** 2 ns to 20,000 s.

**Resolution and accuracy:**  $\Delta$ Freq [Per]/Freq (Graphs 1 and 2).

**Time interval/time interval average**

**Range:** 10 ns to 20,000 s.

**Minimum dead time:** 10 ns.

**Trigger pulse width:** 1 ns (typical) minimum width input at minimum voltage input.

#### Resolution

**Time Interval:** 2 ns  $\pm$  Noise Trigger Error (Graph 3).

**Time Interval Average:**  $\pm$  T.I. Resolution  $\pm$  2 picoseconds.

$\sqrt{\text{intervals averaged}}$

**Accuracy:**  $\pm$  Resolution  $\pm$  Time Base Error (Graph 2)  $\pm$  Trigger Level Timing Error (Graph 4)  $\pm$  700 ps.

#### Ratio B/A

**Range:** both channels accept dc to 500 MHz.

**LSD:** Ratio/[Freq B x Gate Time].

**Resolution and accuracy:**  $\pm$  LSD  $\pm$  [A Trigger Error (Graph 3)/Gate time] x Ratio.

#### Start/Stop

**Range:** both inputs dc to 500 MHz.

**Modes:** A, A  $\pm$  B determined by rear-panel switch.

#### Scaling

**Range:** dc to 500 MHz.

**Scaling factor:** selectable by GATE TIME setting. Scaling factor equals GATE TIME setting/ $10^{-9}$  seconds.

**Input:** input signal through channel A.

**Output:** output frequency equals input frequency divided by scaling factor.

#### Time base

**Standard high stability oven**

**Frequency:** 10 MHz.

**Aging rate:**  $< 5 \times 10^{-10}$  per day.

**Short term:**  $< 1 \times 10^{-11}$  for 1 s average.

**Temperature:**  $< 7 \times 10^{-9}$ , 0 $^{\circ}$ C to 55 $^{\circ}$ C.

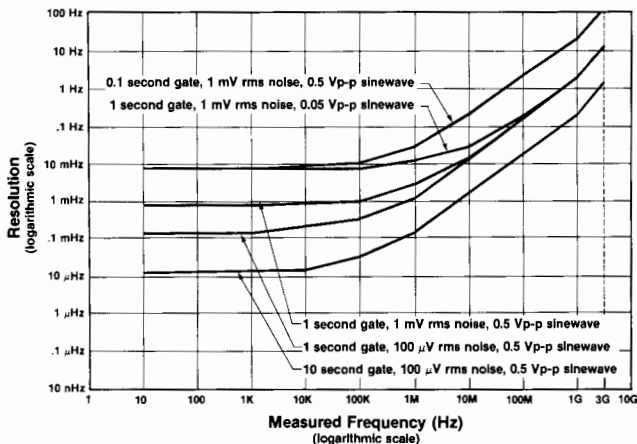

Graph 1. Frequency Resolution. Uncertainties which limit resolution can be reduced by increasing the gate time, reducing the noise on the input signal, or increasing the input signal amplitude.

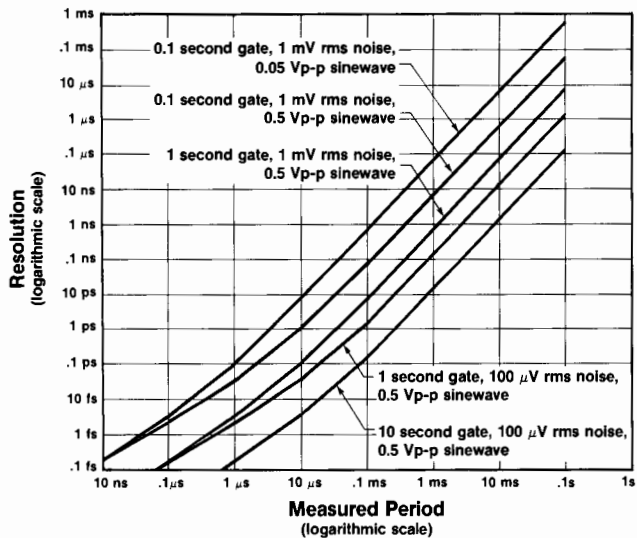

Graph 2. Period Resolution. Uncertainties which limit resolution can be reduced by increasing the gate time, reducing the noise on the input signal, or increasing the input signal amplitude.

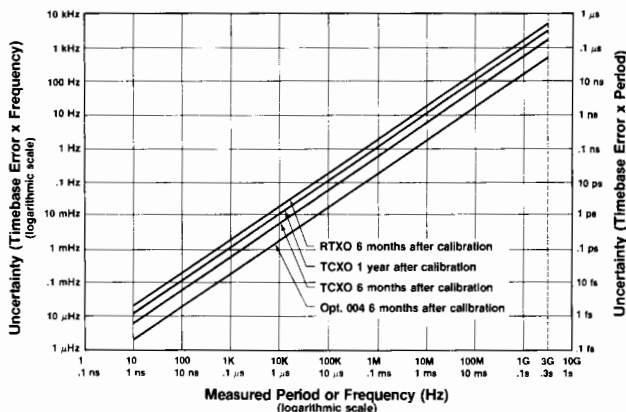

Graph 3. Frequency and Period Uncertainty due to Timebase Error. Timebase error can be reduced by calibrating the timebase more frequently, or by using a timebase with a better aging rate.

**I/O Interface**

**HP-IB Standard**

**Programmable Functions:** Frequency A, Frequency B, Period A.  
**Programmable Controls:** ATTN A, FILTER A, MAN LEVEL A, MAN LEVEL A/B (HP 5384A/85A Only), Gate Time.

**Display:** Normal, Increment, Decrement (digits displayed); Remote, Local; any 12-character message can be displayed on the LCD via a system controller.

**Data Output:** output will be maximum resolution/gate time.

**Format:** 17 characters plus CR and LF.

**Rate:** 4 readings/s maximum at 0.1 s gate.

**HP-IB Interface Functions:** SH1, AH1, T5, TE0, L4, LE0, SR1, RL1, PP0, DC1, DT1, C0, E1 (see page 579).

**Talk Only:** Set with address switch = 31.

**Battery Pack (Option 005 - HP 5384A/85A Only)**

**Battery Type:** sealed lead-acid.

**Capacity:** 4 hours (typ.) at 25°C without Option 004.

**Recharge Time:** 16 hours (typ.) in the standby mode.

**Battery Low Annunciator:** enabled 20 minutes prior to instrument shutdown nominally.

**Battery Save Switch (rear panel):** prevents discharge of interval battery by the oven timebase, Option 004, during instrument standby (STBY).

**Line Failure Protection:** instrument automatically switches to battery in case of line failure.

**Weight:** Option 005 adds 1.4 kg (3 lb) to instrument weight.

**General**

**Check:** 10 MHz self-test.

**Gate Times:** 0.1, 1, or 10 seconds (nominal).

**Display:** 12-digit alphanumeric liquid crystal.

**Display Digits (variable):** frequency 3 to 11; period 3 to 8.

**Timebase Output:** 10 MHz, 25 mV p-p (nominal) into 50 ohm.

**External Timebase Input:** 10 MHz, 0.5 V rms into 500 ohm; 15 V (dc + ac peak) maximum.

**Operating Temperature:** 0° to 50°C.

**Power Requirements**

**ac:** selectable, 18 VA max. (30 VA max., HP 5386A) 115 V + 10%, -25%; 230 V + 10%, -15%: 48 - 66 Hz; 115 V ± 10%: 380 - 420 Hz.

**dc:** (HP 5384A/85A Only): 9 - 15 V dc, 1.0 A maximum.

**Weight**

**HP 5384A/85A:** net, 2.2 kg (4.8 lb). Shipping, 4.1 kg (9 lb).

**HP 5386A:** net, 3.4 kg (7.8 lb). Shipping 5.3 kg (11.9 lb).

**Size:**

**HP 5384A/85A:** 212 mmW x 98 mmH x 276 mmD (8 3/8 in. x 3 3/8 in. x 10 7/8 in.); **HP 5386A:** 212.3 mmW x 88.1 mmH x 421.6 mmD (8 1/2 in. x 3 1/2 in. x 16 1/2 in.).

**Ordering Information**

HP 5384A Frequency Counter 225 MHz \$1590.00

HP 5385A Frequency Counter 1.0 GHz \$1995.00

HP 5386A Frequency Counter 3.0 GHz \$3780.00

Opt 004 High Stability Ovenized Timebase + \$550.00

Opt 910 Additional Operating/Service Manual + \$20.00

Opt W30 Extended repair service. See page 723.

Opt W32 Calibration service. See page 723.

**HP 5384A/85A only**

Opt 001 High Stability TCXO (HP 5384A)\* + \$150.00

Opt 005 Battery Pack + \$300.00

Side Handle Kit: HP 5061-1171 \$50.00

Rack Mount Kit (single): HP 5060-0173 \$90.00

Rack Mount Kit (dual): HP 5060-0174 \$77.50

Vinyl Carrying/Operating Case: HP 34110A \$82.00

\*TCXO time base is standard with HP 5385A/86A

**HP 5386A only:**

Front Handle Kit: HP 5062-3988 \$50.00

Rack Mount Kit (single): HP 5062-3972 \$51.00

Rack Mount Kit (dual): HP 5062-3974 and 5061-9694 \$55.00

For same day shipment, call HP DIRECT at 800-538-8787.

# ELECTRONIC COUNTERS

## Low Cost Counters for Frequency Measurements

HP 5384A, 5385A, 5386A

- Frequency measurements to 3 GHz (HP 5386A)
- Up to 11 digits of resolution, 9 digits per second
- -23.5 dBm sensitivity



HP 5386A: 10 Hz to 3 GHz (pictured above).  
 HP 5385A: 10 Hz to 1 GHz (not shown).  
 HP 5384A: 10 Hz to 225 MHz (not shown).

### HP 5384A/5385A/5386A Frequency Counters

The HP 5384A/85A/86A are HP's lowest priced system frequency counters. They provide outstanding measurement performance for bench, field, and systems applications. Combining wide frequency range, high resolution, high sensitivity, and HP-IB compatibility, these counters compare with instruments which cost much more.

**Portable:** The half-rack-width package makes the HP 5384A/85A/86A portable and saves rack or bench space.

**Versatile Display:** The twelve-digit, liquid-crystal display has larger characters than other LED displays and is easier to read in sunlight. The added feature of remote display extends the usefulness of these counters beyond that of simply making and displaying frequency measurements. User-friendly messages, prompts and measurement units can now be displayed.

**Low Cost Of Ownership:** Integrated design and extensive self-tests result in greater reliability, easier serviceability, and ultimately lower cost of ownership.

### Performance

If your frequency measurement needs are below 3 GHz, the HP 5386A will provide you with the basic performance of traditional microwave counters, at about half the price. The HP 5386A measures frequencies from 10 Hz to 3 GHz with only two input ports, instead of the three ports found with other counters. The high-frequency input measures frequencies from 100 MHz to 3 GHz with -23.5 dBm sensitivity (15 mV rms). In addition, prescaling techniques offer peak-to-peak FM tolerance of at least 100 MHz for your communications applications. You can select the number of digits displayed from 3-to-11 to blank meaningless digits from an unstable signal source. The HP 5386A also solves your systems problems with full remote programmability (via HP-IB standard feature) and remote display capabilities. The high-stability timebase option will lengthen the required calibration period (for kHz accuracy at 3 GHz) from six months to a full year.

### Applications

The HP 5386A fits well in the following application areas for local oscillator, IF, and radio transmitter frequency measurements:

- Military and private communications
- TACAN, DME, and Identify Friend or Foe
- Global Positioning System
- MDS Television

- HP-IB standard
- Systems performance and portability

### Condensed Specifications

**Input Channel A (HP 5384A/85A/86A):** 1 M $\Omega$  // 25 pF.

**Range:** 10 Hz to 100 MHz.

**Sensitivity:** 15 mV rms sine wave 50 Hz (10 Hz for HP 5386A) to 100 MHz; 45 mV peak-to-peak 5 ns minimum pulse width; HP 5384A/85A only: 25 mV rms sine wave 10 Hz to 50 Hz.

**Dynamic range:** 45 mV to 4 V peak-to-peak X attenuator setting.

**Attenuator:**  $\times 1$  or  $\times 20$  nominal above 50 Hz input.

**Low pass filter:** 100 kHz nominal 3 dB point.

**Manual trigger level:** variable, -0.1 V to +0.1 V  $\times$  attenuator.

**Damage level  $\times 1$ :** 10 - 200 Hz 350 V (dc + ac peak).

0.2 - 420 kHz 170 V (dc + ac peak).

0.42 - 10 MHz ( $5 \times 10^7$  V rms Hz)/FREQ.

> 10 MHz 5 V rms.

$\times 20$ : < 1 MHz, Same as  $\times 1$ ; > 1 MHz, 50 V rms.

**Input channel B (HP 5384A):** 50 ohm.

**Range:** 50 to 225 MHz.

**Sensitivity:** 10 mV rms 50 to 200-MHz; 15 mV rms 200 to 225 MHz.

**Dynamic range:** 10 mV to 1 V rms.

**Manual attenuator:** variable,  $\times 1$  to  $\times 5$  (0 to 14 dB) nominal.

**Damage level:** 350 V dc + 5 V rms ac.

**Input Channel B (HP 5385A):** 50 ohm, fused.

**Range:** 90 to 1000 MHz.

**Sensitivity:** 10 mV rms (-27 dBm) 100-1000 MHz; 15 mV rms (-23.5 dBm) 90 - 100 MHz.

**Dynamic range:** 10 mV to 7 V rms (-27 to +30 dBm).

**Manual attenuator:** variable,  $\times 1$  to  $\times 18$  (0 to 25 dB) nominal.

**Damage level:** ac > 1 MHz + 30 dBm (7 V rms).

ac < 1 MHz 2 V rms, dc  $\pm$  5 V.

**Input channel B (HP 5386A):** 50 ohm nominal, VSWR 2.5, typical.  
**Range:** 100 MHz to 3 GHz, prescaled; (90 MHz to 3.5 GHz, typical).

**Coupling:** ac.

**Sensitivity:** 15 mV rms (-23.5 dBm); 5 mV rms (-33.0 dBm) typical.

**Dynamic range:** 15 mV rms to .5 V rms (-23.5 dBm to +7 dBm); 5 mV rms to .5 V rms (-33.0 dBm to +7 dBm), typical.

NOTE: Manual attenuator not active for channel B.

### Frequency A and B

**Range channel A:** 10 Hz - 100 MHz.

**Range channel B:** (HP 5384A) 50 MHz - 225 MHz; (HP 5385A) 90 MHz - 1.0 GHz; (HP 5386A) 100 MHz - 3 GHz.

**LSD displayed:** 10 Hz to 1 nHz.

**Accuracy:**  $\pm$  Resolution  $\pm$  Time base Error  $\times$  Frequency (see Graphs 1 and 3).

### Period A

**Range:** 10 ns to 0.1 s.

**LSD displayed:** .001 fs to 10 ns.

**Accuracy:**  $\pm$  Resolution  $\pm$  Time base Error  $\times$  Period (see Graphs 2 and 3).

### Time base

**Standard HP 5384A:** 10 MHz.

**Aging rate:**  $< 3 \times 10^{-7}$ /mo.

**Temperature:**  $< 5 \times 10^{-6}$ , 0 $^\circ$  to 50 $^\circ$ C, ref. 25 $^\circ$ C.

**Line voltage:**  $< 1 \times 10^{-7}$  for  $\pm 10\%$  variation.

**Standard HP 5385A/86A, Option 001 (HP 5384A):** TCXO, 10 MHz.

**Aging rate:**  $< 1 \times 10^{-7}$ /mo.

**Temperature:**  $< 2 \times 10^{-6}$ , 0 $^\circ$  to 40 $^\circ$ C, ref. 25 $^\circ$ C.

**Line voltage:**  $< 5 \times 10^{-8}$  for  $\pm 10\%$  variation.

### Oven Time base (Option 004)

**Frequency:** 10 MHz.

**Aging rate:**  $< 3 \times 10^{-8}$ /mo. after 30 days continuous operation.

**Temperature:**  $< 1 \times 10^{-7}$ , 0 $^\circ$  to 50 $^\circ$ C, ref. 25 $^\circ$ C.

**Line voltage:**  $< 2 \times 10^{-9}$  for  $\pm 10\%$  variation.

**Battery operation (HP 5384A/85A only):** the instrument operates for 3 hours (typical) with Option 004. In STBY, the oven will operate continuously for 24 hours (typical).

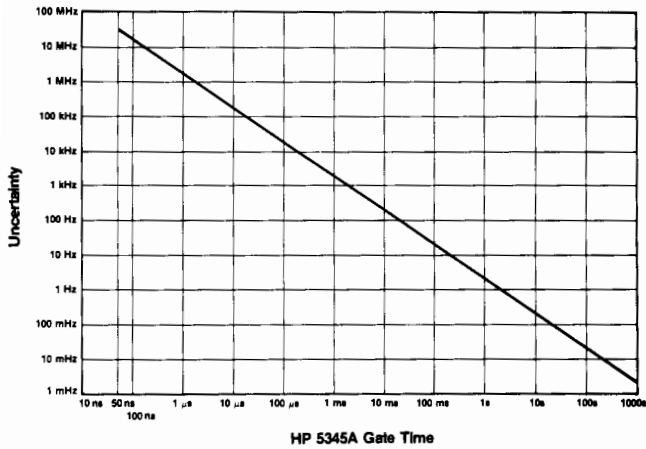

Graph 1. Uncertainty (2 × LSD) due to selected 5345A gate time.

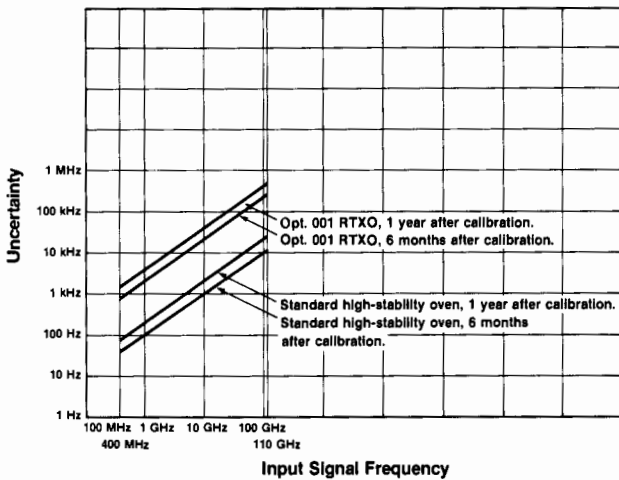

Graph 2. Uncertainty, due to time-base error. Time-base error can be reduced by calibrating the time base more frequently

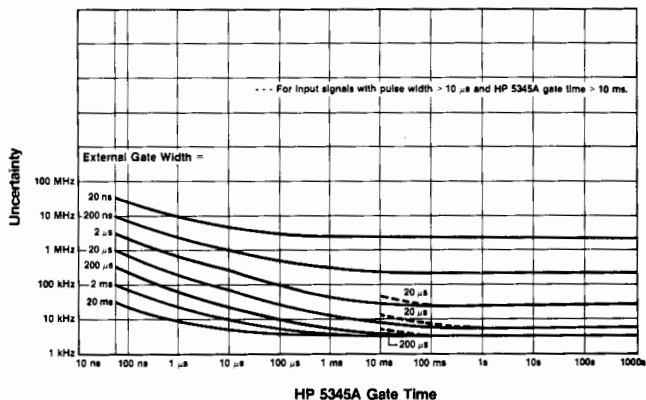

Graph 3. Uncertainty due to jitter (rms jitter) and gate error  

$$\left( \frac{.04}{\text{EXT GATE WIDTH}} \right) \pm 3 \text{ kHz}$$

**Input Specifications**

- 5355A 0.4 - 1.6 GHz (condensed)
- Sensitivity:** -15 dBm.
- Maximum input:** +5 dBm.
- Impedance:** 50 Ω nominal.
- Damage level:** +24 dBm peak (fuse in BNC connector).
- Pulse width:** 150 ns to 1 s
- Pulse repetition rate:** 100 Hz to 2 MHz.

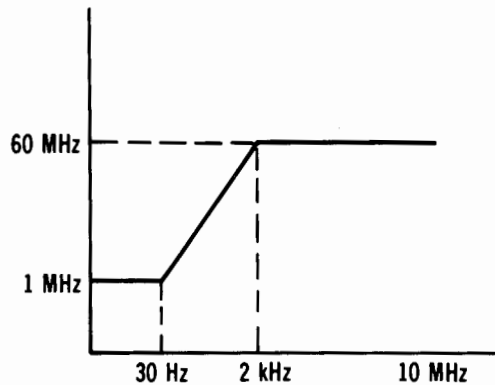

Figure 6 HP 5356D FM Tolerance

**Ordering Information**

	<b>Price</b>
<b>HP 5345A</b> Electronic Frequency Counter	\$14,500
<b>HP 5355A</b> Automatic Frequency Converter	\$10,000
<b>HP 5356A</b> 18 GHz Frequency Converter	\$3,100
<b>HP 5356B</b> 26.5 GHz Frequency Converter	\$3,100
<b>HP 5356C</b> 40 GHz Frequency Converter	\$4,000
<b>HP 5356D</b> 36-110 GHz Harmonic Mixer Driver	\$8,500

**Options for HP 5345A**

<b>Opt 011</b> HP-IB includes remote programming	+\$1,500
<b>Opt 012</b> HP-IB similar to Opt 011, but also includes slope and trigger level controls	+\$1,600
<b>Opt 700*</b> Test Module Adapter (TMA) for MATE System	+\$5,750
<b>Opt 906</b> Rack Flange Kit, HP 5060-8740	+\$65

**Options for HP 5356A**

<b>Opt 001</b> High Pass Filter	+\$320
<b>Opt 006</b> Limiter	+\$600

**Options for HP 5356B**

<b>Opt 001</b> 18-26.5 GHz Waveguide (WR-42)	+\$1,050
<b>Opt 006</b> Limiter	+\$520

**Options for HP 5356C**

<b>Opt 001</b> 26.5-40 GHz Waveguide (WR-28)	+\$940
--	--------

**Options for HP 5356D** (requires an HP 5355A with S/N prefix greater than 2620 - xxxxx and one of the following mixer options)

<b>Opt 005</b> (two HP 5061-5458 parts) 2 cables to connect HP 5356D to HP 1197Q/U/V or W	+\$230
<b>Opt 050</b> (HP 11970Q) 36-50 GHz Harmonic Mixer	+\$1,700
<b>Opt 060</b> (HP 11970U) 40-60 GHz Harmonic Mixer	+\$1,850
<b>Opt 075</b> (HP 11970V) 50-75 GHz Harmonic Mixer	+\$2,250
<b>Opt 110</b> (HP 11970W) 75-110 GHz Harmonic Mixer	+\$2,500

☎ For same day shipment, call HP DIRECT at 800-538-8787.

\* Must be ordered with Opt 12 and an HP 5355A

# ELECTRONIC COUNTERS

## Pulse/CW Microwave Frequency Counter (Cont'd)

### Condensed Specifications

#### Input Specifications (pulse and CW mode)

	HP 5356A	HP 5356B	HP 5356C	HP 5356D
Frequency Range	1.5-18 GHz	1.5-26.5 GHz	1.5-40 GHz	36-110 GHz
Sensitivity				
1.5-12.4 GHz	-20 dBm	-20 dBm	-25 dBm	---
12.4-18 GHz	-15 dBm	-15 dBm	-20 dBm	---
18-26.5 GHz	---	-15 dBm	-20 dBm	---
26.5-34 GHz	---	---	-15 dBm	---
34-40 GHz	---	---	-10 dBm	---
36-50 GHz	---	---	---	-20 dBm
40-60 GHz	---	---	---	-15 dBm
50-75 GHz	---	---	---	-10 dBm
75-95 GHz	---	---	---	-7 dBm
95-105 GHz	---	---	---	-5 dBm
105-110 GHz	---	---	---	-3 dBm
③ Maximum Input				
1.5-12.4 GHz	+5 dBm	+5 dBm	+5 dBm	---
12.4-18 GHz	+5 dBm	+5 dBm	+15 dBm	---
18-26.5 GHz	---	+5 dBm	+15 dBm	---
26.5-40 GHz	---	---	+15 dBm	---
36-110 GHz	---	---	---	+5 dBm
① Damage Level	+25 dBm peak	+25 dBm peak	+25 dBm peak	+24 dBm peak +20 dBm CW
Impedance	50 Ω NOMINAL	50 Ω NOMINAL	50 Ω NOMINAL	Waveguide
SWR (TYPICAL)				
1.5-10 GHz	<21	<21	<21	---
10-18 GHz	<31	<31	<31	---
18-26.5 GHz	---	<31	<31	---
26.5-34 GHz	---	---	<31	---
34-40 GHz	---	---	<51	---
36-110 GHz	---	---	---	<31
Connector	N Male	SMA Male	APC 3.5 Male	Waveguide

① HP 5356A/B See Option 006 for higher damage protection to +39 dBm

② 1.5-6 GHz. +0 dBm (+5 dBm, TYPICAL)

③ 6-12.4 GHz. +5 dBm

#### CW Mode

	HP 5356A/B/C Auto Mode	HP 5356A/B/C/D Man Mode	HP 5356D Auto Mode
FM Tolerance	5356A/B: 15 MHz p-p (60 MHz p-p in special FM mode), rate: dc - 10 MHz 5356C: 60 MHz p-p, rate: dc - 10 MHz	80 MHz p-p rate: dc - 10 MHz	Fig. 6
AM Tolerance	Any modulation index provided the minimum signal level is greater than the counter sensitivity.		50%
Multiple Signal Discrimination	Automatic Amplitude Discrimination (AAD) Automatically measures largest signal provided signal is 8 dB (TYPICAL) greater than any signal within 500 MHz and 20 dB (TYPICAL) greater than any signal over the full frequency range of the head		15 dB TYP
Acquisition Time (TYPICAL)	HP 5356A/B = 400 ms HP 5356C = 1.4 s	15 ms	④ 100 ms
Measurement Time (TYPICAL)	Gate Time ≤ 100 ms: Acquisition time + 4 × HP 5345A GATE TIME + 5345A Sample Rate + 125 ms. Gate Time > 100 ms: Acquisition time + HP 5345A GATE TIME + HP 5345A Sample Rate + 35 ms		
Tracking Rate	---		100 MHz/s (TYPICAL)
LSD Displayed	1 Hz ÷ HP 5345A Gate Time		
Resolution	±2 × LSD ±10 <sup>-10</sup> rms × FREQ		
Accuracy	±2 × LSD ±1 × 10 <sup>-10</sup> rms × FREQ ± time base error × FREQ		

④ 100 ms (input level -5 to +5 dBm).

300 ms (input level -15 to -5 dBm).

400 ms (input level -20 to -15 dBm).

#### Pulse Mode

	HP 5356A/B/C/D Input Auto Mode	HP 5356A/B/C/D Input Man Mode
FM Tolerance (TYPICAL)	50 MHz p-p Chirp	80 MHz p-p Chirp
Acquisition Time (TYPICAL)	<ul style="list-style-type: none"> <li>HP 5356A/B/C Input Man Mode: 0</li> <li>HP 5356A/B Input Auto Mode: <math>100 \mu\text{s} \div (\text{EXT GATE WIDTH} \times \text{PRF}) \div 650 \text{ ms}</math> for EXT GATE ≤ 100 μs (2 ÷ PRF) + 650 ms for EXT GATE &gt; 100 μs</li> <li>HP 5356C Input Auto Mode: <math>(8 \div \text{PRF}) + 1.55\text{s} + 100 \mu\text{s} \div (\text{EXT GATE WIDTH} \times \text{PRF})</math> for EXT GATE ≤ 100s (10 ÷ PRF) + 1.55s for EXT GATE &gt; 100 μs</li> <li>HP 5356D -5 to +5 dBm: (X) = 2.5</li> <li>HP 5356D -15 to -5 dBm: (X) = 3.5</li> <li>HP 5356D -20 to -15 dBm: (X) = 4.5</li> </ul> $(X)s + 2 \left( \frac{100 \mu\text{s}}{\text{EXT GATE WIDTH} \times \text{PRF}} \right)$ For EXT GATE ≤ 100 μs $(X)s + \frac{2}{\text{PRF}}$ For EXT GATE > 100 μs	
Calibration Time	$\left( \frac{\text{HP 5345A GATE TIME}}{\text{EXT GATE WIDTH} \times \text{PRF}} \right) + 75 \text{ ms}$ Performed during 10 consecutive measurements when PULSE Mode is selected, after any front panel change, or when the EXTERNAL GATE width changes by more than 12%. Only calibrates if External Gate is <100 μs.	
Measurement Time (TYPICAL)	Acquisition Time + Calibration Time + HP 5345A SAMPLE RATE + HP 5345A GATE TIME or 100 μs (whichever is greater)	Acquisition Time + Calibration Time + HP 5345A SAMPLE RATE + 60 ms + (1 μs + HP 5345A GATE TIME) ÷ EXT GATE WIDTH × PRF
Pulse Width Min:	100 ns (150 ns, HP 5356D with Opt. 110)	75 ns
Max:	20 ms	20 ms
Pulse Repetition Frequency Min:	50 Hz	50 Hz
Min: (HP 5356D only)	500 Hz	500 Hz
Max:	2 MHz	2 MHz
Minimum On/OFF RATIO	25 dB TYPICAL	
Maximum Video Feed-Through	15 mV p-p TYPICAL for rf burst rise and fall times > 10 ns for HP 5356A/B/C. No limitation for HP 5356D (Waveguide beyond cutoff).	
Minimum EXT GATE WIDTH	20 ns	
LSD Displayed	1 Hz ÷ HP 5345A GATE TIME	
Resolution	±2 × LSD ± 100 Hz rms ± (1 ÷ √HP 5345 GATE TIME × EXT GATE TIME WIDTH) ④	
Accuracy	$\pm 2 \times \text{LSD} \pm 100 \text{ Hz rms} \pm (1 \div \sqrt{\text{HP 5345 GATE TIME} \times \text{EXT GATE TIME WIDTH}}) \text{ ④}$ $\pm \frac{04}{\text{EXT GATE WIDTH}} \pm 3 \text{ KHz}$ $\pm \text{Time base error} \times \text{FREQ}$	

④ For (HP 5345 GATE TIME) ≥ 10 ms and PULSE WIDTH ≥ 10 μs, use

±100 Hz ± (A ÷ √HP 5345 GATE TIME × EXT GATE WIDTH)

A=3, except for W band, where A=7

For EXT GATE signals generated by the HP 5355A, the EXT GATE WIDTH equals the input PULSE WIDTH minus 30 ns (TYPICAL) for the HP 5356A/B/C/D input and equals input PULSE width minus 65 ns (TYPICAL) for the HP 5355A 0.4-1.5 GHz input.

# ELECTRONIC COUNTERS

## Pulse and CW Microwave Frequency Counters

HP 5345A/5355A/5356A,B,C,D

- Pulse microwave measurements, 400 MHz to 110 GHz
- CW measurements, dc to 110 GHz
- -25 dBm sensitivity
- 100 Hz measurement resolution
- 75 nanoseconds minimum pulse width
- 20 nanoseconds minimum external gate

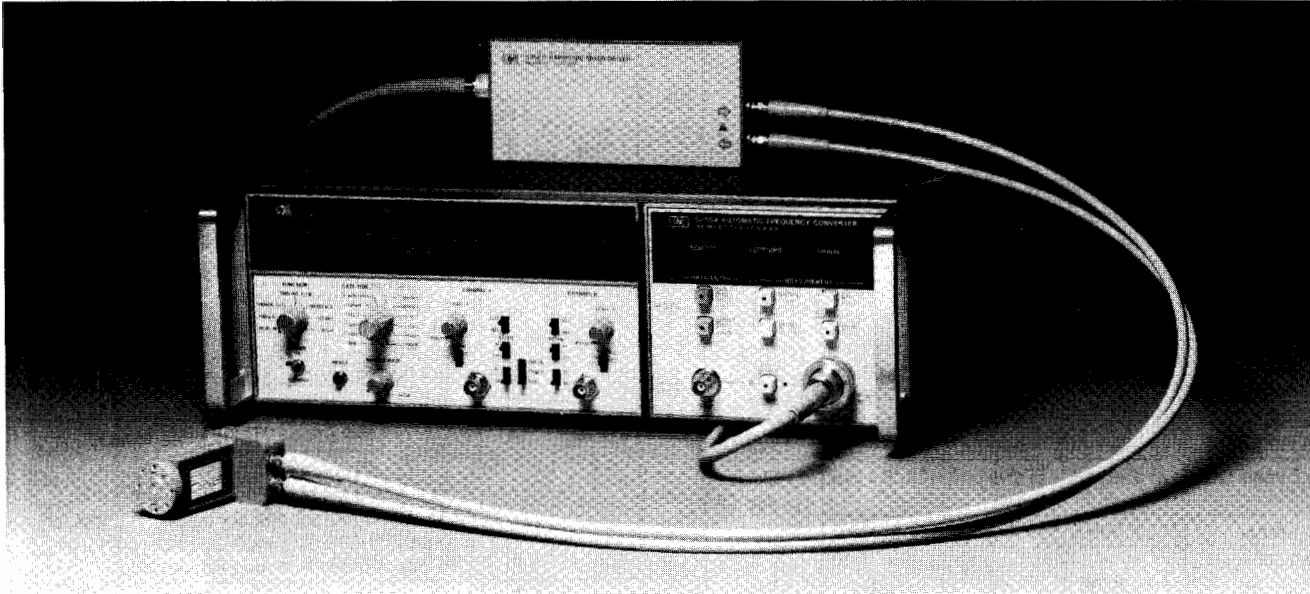

Extending the frequency range of CW and pulse measurements to 100 GHz.



DESIGNED FOR MATE SYSTEMS

### Pulse and CW Measurements to 110 GHz

HP 5355A Automatic Frequency Converter/5345A Counter, together with the HP 5356A, 5356B, 5356C, 5356D Frequency Converter Heads, provide pulse and CW frequency measurement capability to 18, 26.5, 40, and 110 GHz respectively. The HP 5355A's internal microprocessor controls the measurement algorithm, computes the input microwave frequency, and displays the result on the HP 5345A with 11 digits of resolution.

### Automatic Pulse Detection

This 110 GHz counter is a versatile tool for characterizing pulsed signals. Internal pulse-detection circuitry (Figure 1) can detect incoming RF bursts as short as 75 nanoseconds and generate a measurement gate for the counter. With this internally-generated detection gate, the counter can then measure the average frequency of the RF burst.

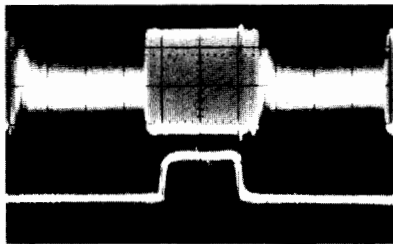

Figure 1. Automatic Pulse Detection

### Sensitivity, FM Tolerance, Automatic Amplitude Discrimination

HP's pulse counters have sensitivity performance to -25 dBm, making measurement of low-level microwave and millimeter-wave signals reliable and accurate. For signals with frequency modulation, these counters also offer high peak-to-peak amplitude discrimination automatically measures the signal with the highest amplitude.

### Exceptional Resolution, High Accuracy

You can select the measurement gate time of this counter from 50 nanoseconds to 1000 seconds. Increasing the measurement gate time increases the resolution of measurement results. In fact, this counter can measure a 110 GHz signal with resolution down to 100 Hz and accuracy as good as 3 kHz in pulse mode. This performance can improve to 1 Hz in CW mode.

Even if your application requires narrow external gates, the counter can still achieve fine resolution through an automatic frequency averaging scheme (Figure 2). When the measurement gate is longer than the external gate, the counter will automatically take several measurements of the repetitive signal. It will then average the results to yield better resolution. The measurement process is completely automatic—making the counter easy to work with.

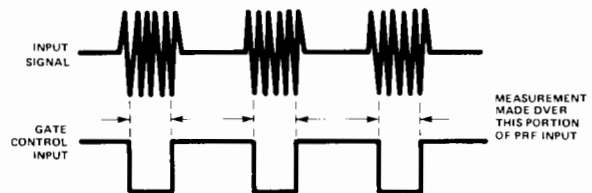

Figure 2. Frequency averaging to increase resolution

### Systems Performance, 9000 Measurements/Second

These counters are fully programmable over HP-IB. Measurement throughput of 9000 measurements/second saves you money by reducing test time.



# ELECTRONIC COUNTERS

## Pulse/CW Microwave Frequency Counter (cont'd)

### Summary Specifications

#### Functions

Frequency (Pulse or CW), frequency profiling, PRF, PRI, pulse width, and offtime

#### Input characteristics

	Input 1 (50 Ω)	Input 2 (1 MΩ)	Input 2 (50 Ω)
Frequency range	500 MHz-20, 26.5, 40 GHz	10 Hz-80 MHz	10 MHz-525 MHz
Sensitivity		25 mV <sub>rms</sub>	25 mV <sub>rms</sub>
0.5-12.4 GHz	-28 dBm		
12.4-20 GHz	-23 dBm		
0.5-26.5 GHz (opt. 026, 040)	-20 dBm		
26.5-40 GHz (opt. 040)	dBm = 0.37 × f(in GHz)-29.8		

#### Frequency (INPUT 1)

##### Automatic & manual acquisition:

500 MHz - 20 GHz;  
500 MHz - 26.5 GHz (opt. 026);  
500 MHz - 40 GHz (opt. 040)

**Least significant digit:** 1 MHz to 1 Hz for frequency, 0.001 Hz for PRF.

##### Pulse frequency measurements

**Pulse width (minimum):** manual mode- 60 ns; auto mode- 100 ns

**Pulse rep freq:** minimum-1 Hz; maximum- 2 MHz

**Measurement time, resolution, accuracy:** see datasheet

##### CW frequency measurements

**FM tolerance:** 55 MHz p-p

**Tracking speed (fast acquisition):** 800 MHz/s

**Acquisition time:** manual mode- <40 ms; automatic mode, fast acq.- <100 ms

**Gate times (1 Hz resolution):** 200 to 1000 ms

**Measurement time:** ≥8.5 ms, (in Dump Mode)

**Accuracy:** See datasheet

#### Pulse parameters (INPUT 1)

	Pulse width	PRI	Offtime	PRF
Min/Max	60 ns/ 10 ms	500 ns/1 s	400 ns/1s	1 Hz/2 MHz
LSD	(PW < 1 ms)- 1 ns; (PW ≥ 1 ms)- 100 ns			to 0.001 Hz
Accuracy (100 ave.)	±(20 ns + time base uncertainty × measurement) ± LSD		± (20 ns) × (PRF) <sup>2</sup> ± LSD ± time base uncertainty	

#### Profile (INPUT 1)

**Frequency range (min/max for Y axis):** 500 MHz/40 GHz

**FM chirp tolerance (Max span for Y axis):** 50 MHz p-p

**Time range (min/max span for X axis):** 100 ns/10 ms

**Time resolution:** 1 ns

**Internal gate width:** minimum: 11 to 23 ns

typical minimum: 14 ns

**External gate width (minimum):** manual acquisition 20 ns

auto acquisition 60 ns

**Number of data points:** Up to 100

#### Profile frequency measurements

**Printers supported:** HP 2225A, HP 2227B, HP 3630A, opt. 002

**Profile phase measurements:** see Application Note 377-4 for details. Computer required.

#### Frequency (INPUT 2)

**Range:** 10 Hz to 525 MHz

**Accuracy:** 0.001 Hz to 1 Hz

**Resolution/LSD:** 0.001 Hz to 1 Hz

#### Options

**Option 001 oven time base:** aging rate < 5 × 10<sup>-10</sup> per day

**Options 006, increased damage level:** pulsed- + 50 dBm (100 watts) peak; CW- +39 dBm (8 watts)

**Option 010 oven time base:** aging rate < 7 × 10<sup>-10</sup> per week

**(Standard time base:** aging rate < 1 × 10<sup>-7</sup> per month)

**Option 026:** frequency extensions for input 1 to 26.5 GHz

**Option 040:** frequency extension for input 1 to 40 GHz

#### Ordering Information

	Price
HP 5361B Pulse/CW Microwave Counter	\$11,900
Opt 001 Oven Time Base	+\$950
Opt 006 Microwave Limiter	+\$950
Opt 010 High Stability Time Base	+\$1,500
Opt 026 26.5 GHz Frequency Extension	+\$2,600
Opt 040 40 GHz Frequency Extension	+\$7,000
Opt 700 MATE Interface	+\$750
Opt 908 Rackmount kit for use with front handles removed	+\$34
Opt 910 Additional operating and programming manual	+\$80
Opt 913 Rackmount kit for use with supplied front handles	+\$83
Opt 915 Service Manual	+\$200
Opt W30 Extended repair service. See page 723.	+\$315
Opt W32 Calibration service. See page 723.	+\$525

## Built-in Profiling Reduces Costs and Simplifies Measurements

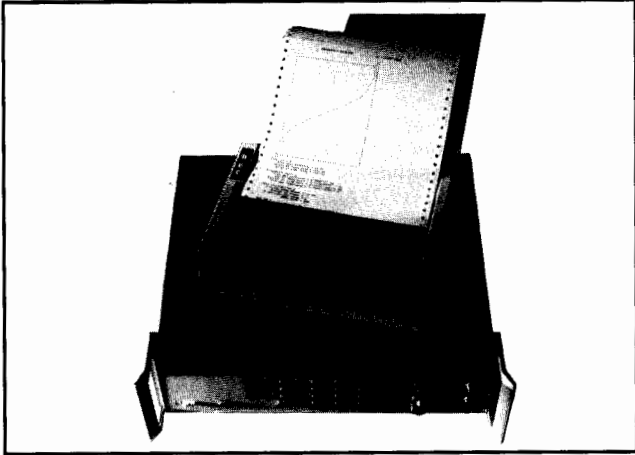

**Figure 2.** Have the power of a frequency profiling system on your bench with the HP 5361B and a printer.

### Demanding designs require you to know more about your signals

Frequency profiling is becoming more important as demands are increased on radar, EW, transponder, and communication equipment. Unwanted frequency perturbations on a switching voltage controlled/ digitally tuned oscillator (VCO/DTO) degrade performance. If the linearity of a chirp deviates too much from the desired characteristics, the range side lobes will be out of spec. Characterizing frequency transients, modulation, and linearity is key to lowering costs and increasing performance in future systems.

#### Built-in profiling is inexpensive

Previously, frequency profiling required a microwave counter, pulse generator, computer, software, and much interconnection. The PROFILE function provides the capability to make frequency measurement inside a pulse with no extra equipment, other than a printer. The printer is used to output a plot of the frequency vs. time (see figure 2).

#### Easy-to-use because it is automatic

An external gate is not needed for pulsed signals. Pushing the PROFILE key starts the profiling function. The signal is acquired, the pulse width measured, then frequency profiling is started. When the profile is finished, it is sent to the printer for a permanent hardcopy.

#### The most accurate method of frequency profiling

Gating error is an inherent part of most counter architectures. This can be a small but consistent error of less than 100 ps. The algorithms and hardware associated with PROFILE reduce this gating error to a negligible amount providing more accurate measurements.

### The Cost-effective Choice for Manufacturing and Service

Test software to control the HP 5361B can be written two different ways. The counter can be controlled by easy to remember English-like commands, or Hewlett-Packard's Interactive Test Generator (ITG, see below).

#### ITG: The easiest way to generate test software—use a mouse

Interactive Test Generator (ITG) can be used to generate test software for the HP 5361B. This allows using a mouse for easy code generation for a rack of HP instruments. The mouse is used to invoke different functions on graphical front panels, displayed on a computer.

#### High-speed throughput lowers production costs

The counter can also produce results at rates up to 100 measurements per second. The improved efficiency saves you time and money by letting you test more devices for a given time.

### Extended calibration cycles keep the HP 5361B working and out of the calibration lab

The only periodic maintenance required for the HP 5361B is time-base calibration. Complete internal calibration is performed at power up or upon command. To keep the counter out of the calibration lab even longer, Option 001 or 010 can be included. Option 010 extends the calibration cycle to five years, and still provide kHz measurement accuracy on a 40 GHz frequency measurement.

### The Power Required for R&D on Tomorrow's Radars, VCOs, and DTOs Measures simple parameters easily; flexible enough for complex signals

The HP 5361B makes frequency, timing, and profiling measurements at the touch of a button. The counter also makes more complex measurements. You can measure the carrier frequency of agile signals, staggered PRIs, or the frequency transients in a pulsed or CW signal.

### Frequency modulation on the pulse (FMOP) is easy and inexpensive to quantify

Frequency profiling a radar chirp to determine linearity or characterizing the droop when turning on a high power stage is easy with the HP 5361B's PROFILE function and uses much less equipment.

### One counter measures radar pulse parameters and the STALO

The HP 5361B features state-of-the-art pulse microwave measurements without sacrificing its CW performance. This counter can characterize your radar pulse, and has the needed features for measurements that require high-CW precision, such as testing the Stable Local Oscillator (STALO). The counter measures with 1 Hz resolution up to 40 GHz.

### Resist input burnout with a high damage level

Option 006 extends the damage level to +50 dBm for pulses of 1  $\mu$  second and less, or approximately +40 dBm for CW signals. The standard damage level, and damage level above 26.5 GHz, is +25 dBm, more than enough for lower power applications.

### The right mix of features simplifies VCO and DTO testing

The HP 5361B has features to accurately and easily test VCOs and DTOs. PROFILE lets you measure the step response with gate widths down to 11 ns. Post-tuning drift and settling time can also be measured in this way. Fast Track is useful for measuring tuning linearity because it tracks a signal that is moving at up to 800 MHz per second. The counter outputs results at up to 100 readings per second.

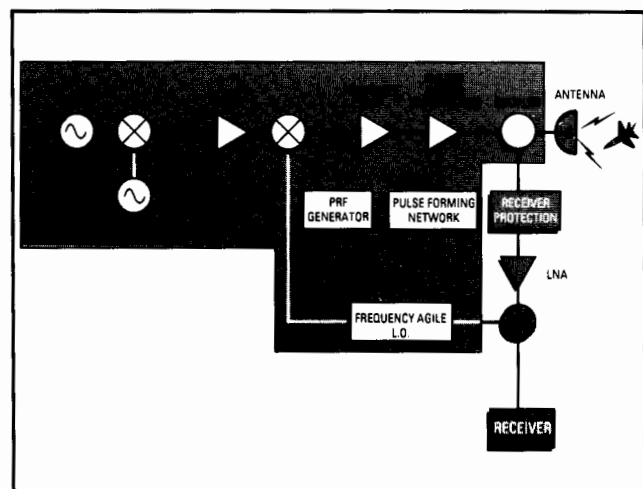

**Figure 3.** Measure all your signals, from the STALO to the output pulse, with the HP 5361B.

# ELECTRONIC COUNTERS

## Pulse/CW Microwave Frequency Counter

### HP 5361B

- Frequency extensions to 26.5 GHz, 40 GHz, and built-in frequency profiling
- Measure frequency (pulsed or CW), PRI, PRF, pulse width, offtime, and frequency profiles directly

DESIGNED FOR  
MATE  
SYSTEMS

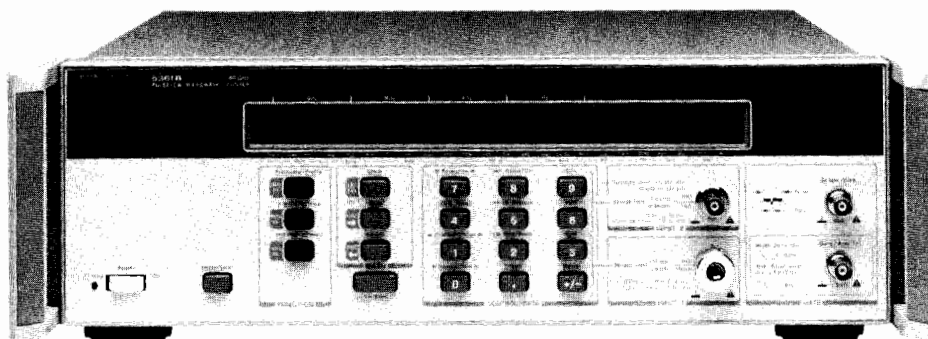

HP 5361B

### HP 5361B Universal Counter

#### Make All Your Frequency Measurements with One Microwave Counter

The HP 5361B was designed for both high precision pulse and CW performance. It is the only pulse/CW microwave counter with frequency of frequency modulation profiling built-in. Characterize systems or components of radar, EW, and communications. Lower your equipment cost by eliminating the need for a separate CW counter, pulse generator, and computer.

#### Precision pulse measurement provides accuracy to spare

The HP 5361B measures 40 GHz pulsed microwave signals with up to 1 Hz resolution. Six separate pulse microwave measurements are available to characterize your signals: frequency, PRF, PRI, pulse width, off-time, and frequency profiling.

#### True CW performance at no extra cost

Count CW signals from 10 Hz to 40 GHz, with 1 Hz resolution. Resolution improves to 0.001 Hz at 100 kHz. Other CW counter features include Fast Track and Low FM Rate. Fast Track enables the counter to measure a signal that is sweeping at up to 800 MHz/s when characterizing a VCO or DTO. Low FM Rate allows measurements on a signal that is varying slowly in frequency.

#### Frequency profiling made easy and inexpensive

Intentional or unintentional FM on your carrier, such as a chirp, is easy to measure and plot with the HP 5361B and a printer. The function **Profile**, with a printer, makes it possible to accurately determine the frequency vs. time characteristics of your pulsed or CW signal, replacing a computer, pulse generator, and much software.

#### Automatic measurements simplify testing.

The HP 5361B's "suite" of automatic features, Auto-Suite, is designed to make your testing easier. The counter performs many automatic operations that must be done manually in other counters. All you need to do is connect your signal and choose the function, and the counter does the rest. Automatic features include the following:

**Auto-Calibration-** A major calibration is performed internally at power up, or on command. No external connections are needed.

**Auto-Assess-** Determines if the signal is pulsed or CW and shifts to the correct measurement routines.

**Auto-Acquire-** Automatically acquires a signal from 500 MHz to 40 GHz.

**Auto-Gate-** Sets the gate width for CW signals (dependent on the selected resolution). Pulsed signals are provided a gate width calculated to minimize measurement errors.

**Auto-PRF-** Allows you to measure the carrier frequency of signals with stable or changing PRIs, from 2 MHz to 50 Hz. A low-PRF mode enables measurements to 1 Hz PRF.

- 1 Hz resolution on pulsed and CW signals
- Up to +50 dBm pulse level protection (optional)
- 60 ns minimum pulse width
- Measurements down to 1 Hz PRF

**Auto-Position-** Positions the gate inside the microwave pulse so that turn-on and turn-off transients do not corrupt the measurement.

**Auto-Track-** After a CW signal has been acquired, the HP 5361B tracks a signal sweeping up to 800 MHz per second in Fast Track.

**Auto-Resolution-** No calculator needed. You set the resolution and the counter calculates the number of pulses to average for the true requested resolution. And smoothing improves resolution.

**Auto-Indicate-** Displays the measurement and indicates whether the signal is pulsed or CW.

#### Scope-View gives you confidence in externally gated measurements

View the exact position of the measurement on any 100 MHz oscilloscope. For externally gated measurements, there is always a concern that the gating signal may not coincide with the microwave pulse. Scope-View enables you to easily set up an externally gated measurement because you can see the downconverted pulse with a dc offset at the actual measurement interval.

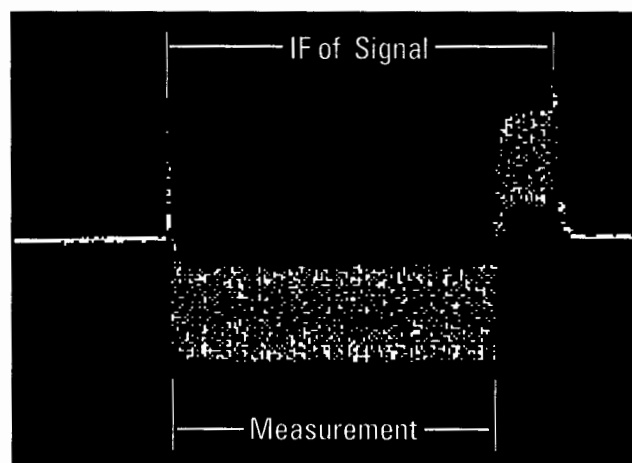

Figure 1. Set up externally gated measurements with confidence using Scope-View.

# ELECTRONIC COUNTERS

## Automatic Microwave Counters

HP 5340A

123

- Single input 10 Hz to 18 GHz
- Automatic amplitude discrimination
- High sensitivity -35 dBm

- Optional extension to 23 GHz
- High AM and FM tolerance
- Exceptional reliability



HP 5340A



### HP 5340A Frequency Counter

The HP 5340A Frequency Counter is an easily used, versatile instrument for direct measurement of frequencies from 10 Hz through 18 GHz via a single input connector.

The exceptional sensitivity of this instrument enhances measurement in the microwave field, where signals are commonly low-level and connected via directional coupler or lossy devices.

Access to the HP Interface Bus via Option 011 provides a flexible systems interface. The ability to program octave range through this input reduces acquisition time to less than 40 ms (typical).

### HP 5340A Specifications

#### Signal Input

##### Input 1

**Range:** 10 Hz to 18 GHz.

**Symmetry:** sinewave or squarewave input (40% duty factor, worst case).

**Sensitivity:** -30 dBm, 10 Hz to 500 MHz; -35 dBm, 500 MHz to 10 GHz; -25 dBm, 10 to 18 GHz.

**Dynamic range:** 37 dB, 10 Hz to 500 MHz; 42 dB, 500 MHz to 10 GHz; 32 dB, 10 GHz to 18 GHz.

**Impedance:** 50  $\Omega$ .

**VSWR:** <2:1, 10 Hz-12.4 GHz; <3:1, 12.4-18 GHz.

**Connector:** precision Type N.

**Coupling:** dc to load, ac to instrument.

**Damage level:** +30 dBm.

Total power (ac + dc) not to exceed 1 watt. See Option 006 for up to +39 dBm protection.

**Acquisition time:** <150 ms mean typical.

##### Input 2

**Range:** 10 Hz-250 MHz direct count.

**Sensitivity:** 50 mV rms. 150 mV p-p pulses to 0.1% duty factor; minimum pulse width 2 ns.

**Impedance:** 1 M $\Omega$  shunted by <25 pF.

**Connector:** type BNC female.

**Coupling:** ac.

**Maximum input:** 200 V rms, 10 Hz to 100 Hz; 20 V rms, 100 Hz to 100 kHz; 2 V rms, 100 kHz to 250 MHz.

**Automatic amplitude discrimination:** automatically selects the strongest of all signals present (within 250 MHz to 18 GHz phase-lock range), providing signal level is: 6 dB above any signal within 200 MHz; 10 dB above any signal within 500 MHz; 20 dB above any signal, 250 MHz-18 GHz (typical performance).

**Maximum AM modulation:** any modulation index as long as the minimum voltage of the signal is not less than the sensitivity specification.

#### Time Base

**Crystal frequency:** 10 MHz.

#### Stability

**Aging rate:** < $3 \times 10^{-7}$  per month.

**Short term:** < $5 \times 10^{-10}$  rms for 1 second averaging time.

**Temperature:** < $\pm 2 \times 10^{-6}$  over the range of 0°C to 50°C.

**Line variation:** < $\pm 1 \times 10^{-7}$  for 10% line variation from nominal.

**Output frequency:** 10 MHz,  $\geq 2.4$  V square wave (TTL compatible) available from rear panel BNC.

**External time base:** requires 10 MHz approximately 1.5 V p-p sine wave or square wave into 1 k $\Omega$  via rear panel BNC. Switch selects either internal or external time base.

**Optional time base (opt 001) aging rate:** < $5 \times 10^{-10}$  per day after 24-hour warm-up for less than 24 hour off-time.

#### General

**Accuracy:**  $\pm 1$  LSD  $\pm$  time-base error.

**Resolution:** front-panel switch selects 1 Hz to 1 MHz.

**Display:** eight digit LED with positioned decimal point and appropriate measurement units of kHz, MHz, or GHz.

**Self check:** counts and displays 10 MHz for resolution chosen.

**Sample rate:** controls time between measurements. Continuously adjustable from 50 ms typical to 5 seconds. HOLD position holds display indefinitely. RESET button resets display to zero and activates a new measurement.

**HP-IB interface functions:** SH1, AH1, T1, L2, SL1, RL2, PP0, DC1, DT1, C0, E1 (see page 574).

**Operating temperature:** 0°C to 50°C.

**Power:** 115 V or 230 V +5%, -10%, 48-66 Hz, 100 VA.

**Weight:** net, 11.3 kg (25 lb). Shipping, 14.1 kg (31 lb).

**Size:** 88.2 H x 425 W x 467 mm D (3.47" x 16.75" x 18.39")

#### Ordering Information

	Price
HP 5340A Frequency Counter	\$18,100
Opt 001 High Stability Time Base	+ \$950
Opt 002 Rear Panel Connectors	+ \$230
Incompatible with Option 006. Consult factory special to combine these Options.	
Opt 005 Frequency Extension to 23 GHz	+ \$690
Incompatible with Option 006. Consult factory special to combine these Options.	
Opt 006 Limiter Input Protection (+39 dBm)	+ \$865
Incompatible with Option 002 & Option 005. Consult factory special to combine these Options.	
Opt 011 Remote Programming-Digital Output (HP-IB)	+ \$725
Opt 908 Rack Flange Kit	+ \$65
Opt 1A3 Bellcore CLEI Barcode Sticker	\$30

# ELECTRONIC COUNTERS

## Automatic Microwave Counters

HP 5342A & 5343A

### Optional Time Base (option 001)

**Crystal frequency:** 10 MHz.

#### Stability

**Aging rate:**  $<5 \times 10^{-10}$ /day after 24-hour warmup.

**Temperature:**  $<7 \times 10^{-9}$  over the range  $0^{\circ}\text{C}$  to  $50^{\circ}\text{C}$ .

**Short term:**  $<1 \times 10^{-10}$  for 1 second averaging time.

**Line variation:**  $<1 \times 10^{-10}$  for 10% change from nominal.

**Warm-up:**  $<5 \times 10^{-9}$  of final value 20 minutes after turn-on, at  $25^{\circ}\text{C}$ .

### Amplitude Measurement (opt 002) (HP 5342A only)

#### Input 1

**Frequency range:** 500 MHz–18 GHz.

**Dynamic range (frequency and level)**

–22 dBm to +22 dBm 500 MHz to 12.4 GHz

–15 dBm to +22 dBm 12.4 GHz to 18 GHz

**Maximum operating level:** +22 dBm.

**Damage level:** +25 dBm, peak.

**Resolution:** 0.1 dBm.

**Accuracy:**  $\pm 1.5$  dB (excluding mismatch uncertainty).

**SWR:**  $<2:1$  Typical (amplitude measurement).

$<5:1$  Typical (frequency measurement).

**Measurement time:** 100 ms + frequency measurement time.

**Display:** simultaneously displays frequency to 1 MHz resolution and level. (Option 011 provides full frequency resolution on HP-1B).

#### Input 2 (50 $\Omega$ impedance only)

**Frequency range:** 10 MHz–520 MHz.

**Dynamic range (frequency and level):** –17 dBm to +20 dBm.

**Damage level:** +24 dBm.

**Accuracy:**  $\pm 1.5$  dB (excluding mismatch uncertainty).

**SWR:**  $<1.8:1$  Typical

**Measurement time:** 100 ms + frequency measurement time.

**Display:** simultaneously displays frequency and input level.

### Extended Dynamic Range (opt 003) (HP 5342A only)

**Frequency range:** 500 MHz to 18 GHz.

**Sensitivity:** 500 MHz to 12.4 GHz: –22 dBm.  
12.4 GHz to 18 GHz: –15 dBm.

**Maximum operating level:** +22 dBm.

**Dynamic range:** 500 MHz to 12.4 GHz: 44 dB.  
12.4 GHz to 18 GHz: 37 dB.

**Damage level:** +25 dBm, peak.

**SWR:**  $<5:1$ .

### Microwave Limiter (option 006)

#### Input 1

**Frequency range:** HP 5342A: 500 MHz – 18 GHz.

HP 5343A: 500 MHz – 26.5 GHz.

**Sensitivity:** HP 5342A: 500 MHz – 12.4 GHz: –21 dBm.

12.4 GHz – 18 GHz: –15 dBm.

HP 5343A: 500 MHz – 12.4 GHz: –30 dBm.

12.4 GHz – 18 GHz: –24 dBm.

18 GHz – 26.5 GHz: –18 dBm.

**Maximum operating level:** +7 dBm.

**Damage level:** 500 MHz – 6 GHz: +39 dBm (8W).

6 GHz – 18 GHz: +36 dBm (4W).

(HP 5343A only) 18 GHz – 26.5 GHz: +34.8 dBm (3W).

**SWR:** 2.5:1, 500 MHz – 10 GHz.

3.5:1, 10 GHz – 18 GHz/26.5 GHz.

**Note:** Option 006 is incompatible with Option 002, Option 003, and Option 005 for HP 5342A. Please consult factory special to combine Options 005 and 006.

#### General

**Accuracy:**  $\pm 1$  LSD  $\pm$  time-base error.

**Resolution:** front panel push buttons select 1 Hz to 1 MHz.

**Display:** 11 digit LED display, sectionalized to read GHz, MHz, kHz, and Hz.

**Self-check:** selected from front panel pushbuttons displays 75 MHz for resolution chosen.

**Frequency offset:** selected from front panel pushbuttons. Displayed frequency is offset by entered value to 1 Hz resolution.

**Frequency multiply:** (HP 5343A only) (mx  $\pm$ b) measured data is multiplied by any integer up to 99. Offset can then be added or subtracted. Front-panel selectable.

**Totalize (HP 5343A only):** input 2 can totalize at rates up to 520 MHz. Readout on the fly is controlled by front panel or HP-1B.

**Sample rate:** variable from less than 20 ms between measurements to HOLD which holds display indefinitely.

**IF out:** rear panel BNC connector provides 25 MHz to 125 MHz output of down-converted microwave signal.

**Power requirements:** 100/120/220/240 V rms, +5%, –10%, 48–66 Hz; 100 VA max.

**Weight:** net 9.1 kg (20 lb). Shipping 12.7 kg (28 lb).

**Size:** 133 H x 213 W x 498 mm D (5.25" x 8.38" x 19.6").

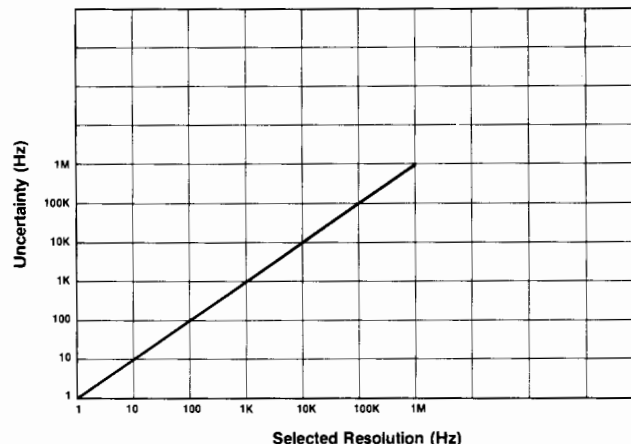

Graph 1. Uncertainty due to selected resolution.

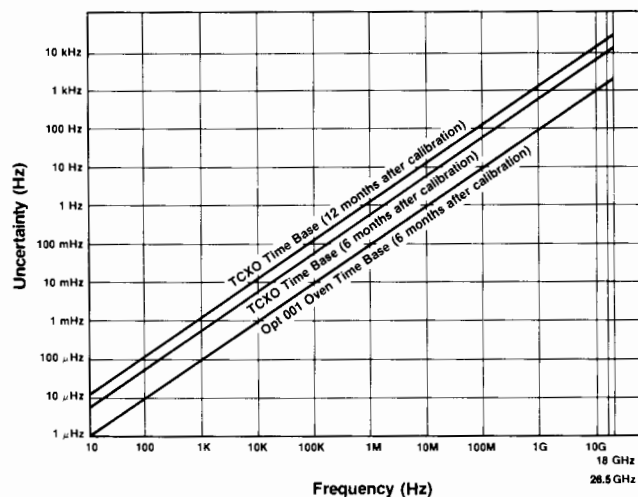

Graph 2. Uncertainty due to time base error can be reduced by calibrating the time base more frequently, or by using a time base with a lower aging rate.

### Ordering Information

HP 5342A Frequency Counter

**Price**

\$11,000

HP 5343A Frequency Counter

\$12,600

### Options and Accessories (both models)

Opt 001 High Stability Time Base

+ \$900

Opt 002 Amplitude Measurement (HP 5342A Only)

+ \$2,500

Opt 003 Extended Dynamic Range (HP 5342A Only)

+ \$795

Opt 004 Digital-To-Analog Converter

+ \$400

Opt 005 Frequency Extension to 24 GHz (HP 5342A Only)

+ \$500

Opt 006 Limiter Input Protection (+39 dBm)

+ \$850

Opt 011 Digital Input/Output (HP-1B) (Cable Not Incl)

+ \$550

Opt 908 Rack Mounting Adapter Kit

+ \$100

Opt 1A3 Bellcore CLEI Barcode Sticker

+ \$30

For a comparable product, see the HP 5347 counter/power meter on page 118.

HP K70-59992A: Rack Mounting Adapter Kit With Slot for access to front connectors from rear.

HP 10842A: Extender Board Kit

\$800

# ELECTRONIC COUNTERS

## CW Microwave Frequency Counters

### HP 5342A, 5343A

- Automatic measurements to 18 GHz/26.5 GHz
- Portability
- Wide FM tolerance

- Amplitude measurement in dBm (HP 5342A Option 002)
- High input sensitivity
- Digital-to-analog converter (Option 004)

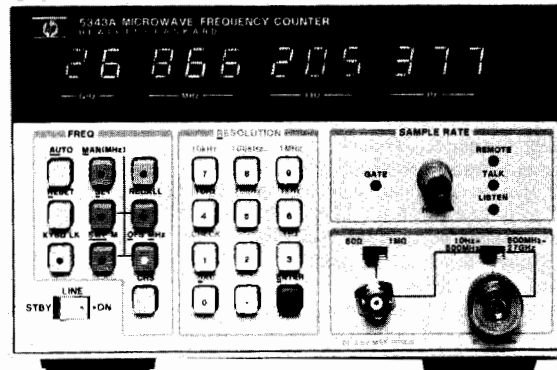

HP 5342A

### HP 5342A & 5343A Microwave Counters

#### Portability

The HP 5342A and HP 5343A Microwave Counters provide automatic frequency measurement to 18 or 26.5 GHz in highly portable packages. The operating range of the HP 5342A can be extended to 24 GHz with Option 005.

#### Amplitude Measurements (Option 002, HP 5342A only)

Option 002 adds the ability to measure and display the power level of the input in dBm. The 11-digit LED display presents amplitude measurement to 0.1 dBm resolution. Also, the same option extends the instrument's dynamic range to enable frequency measurements to +22 dBm.

#### FM Tolerance

Measuring a carrier frequency while it is being frequency modulated has broad appeal in the communication industry and elsewhere. Both the HP 5342A and HP 5343A can tolerate peak-to-peak FM deviation to 50 MHz.

#### Digital-To-Analog Converter (Option 004)

Option 004 lets you convert any three consecutive displayed digits (frequency or amplitude) into an analog voltage output on the rear panel. This makes the monitoring of microwave-oscillator-frequency drift easy to make with only a stripchart recorder.

#### Scaling and Offset Functions

The versatility of the microprocessor-controlled keyboard allows you to perform math functions by means of a few key strokes. Frequency values to 1 Hz resolution can be added to or subtracted from the measured frequency for IF offset application. The HP 5343A also offers an  $mx \pm b$  mode for both scaling and offset functions.

### HP 5342A Specifications

#### Signal Input

##### Input 1

**Frequency range:** HP 5342A: 500 MHz to 18 GHz

HP 5343A: 500 MHz to 26.5 GHz

**Sensitivity:** HP 5342A: 500 MHz to 12.4 GHz: -25 dBm

12.4 GHz to 18 GHz: -20 dBm

HP 5343A: 500 MHz to 12.4 GHz: -33 dBm

12.4 GHz to 18 GHz: -28 dBm

18.0 GHz to 26.5 GHz: -23 dBm

**Maximum input:** +7 dBm (See Option 002, 003 for higher levels).

**Impedance:** 50, nominal.

**Connector:** HP 5342A: Precision Type N female.

HP 5343A: APC 3.5 male with collar.

**Damage level:** +25 dBm, peak (See Option 006 for +39 dBm protection).



HP 5343A

**Coupling:** dc to load, ac to instrument.

**SWR:** < 2:1, (Typical) 500 MHz-10 GHz

< 3:1, (Typical) 10 GHz-18 GHz/26.5 GHz

**FM tolerance:** switch selectable (rear panel)

**Wide:** 50 MHz p-p worst case.

**Normal:** 20 MHz p-p worst case.

**Narrow:** (HP 5343A only) 6 MHz p-p worst case.

For Modulation Rates from dc to 10 MHz.

**AM tolerance:** any modulation index provided the minimum signal level is not less than the sensitivity specification.

**Automatic amplitude discrimination:** automatically measures the largest of all signals present, providing that signal is 6 dB above any signal within 500 MHz; 20 dB above any signal, 500 MHz-18 /26.5 GHz.

#### Modes of Operation

**Automatic:** counter automatically acquires and displays highest level signal within sensitivity range.

**Manual:** center frequency entered to within  $\pm 40$  MHz of true value.

#### Acquisition Time

##### Automatic Mode

Narrow FM 200 ms worst case (HP 5343A only)

Normal FM 530 ms worst case

Wide FM 2.4 s worst case

**Manual mode:** 80 ms after frequency entered.

#### Input 2

**Frequency range:** 10 Hz to 520 MHz direct count.

**Sensitivity: 50  $\Omega$ :** 10 Hz to 520 MHz: 25 mV rms.

**1 M $\Omega$ :** 10 Hz to 25 MHz: 50 mV rms.

**Impedance:** selectable 1 M $\Omega$ , <50 pF or 50  $\Omega$  nominal.

**Coupling:** ac.

**Connector:** type BNC female.

**Maximum input 50  $\Omega$ :** 3.5 V rms (+24 dBm) or 5 V dc, fuse protected

**1 M $\Omega$ :** 200 V dc + 5 V rms.

#### Time Base

**Crystal frequency:** 10 MHz.

#### Stability

**Aging rate:**  $< 1 \times 10^{-7}$ /month.

**Temperature:**  $< \pm 1 \times 10^{-6}$  over the range 0°C to 50°C.

**Short term:**  $< 1 \times 10^{-9}$  for 1 second averaging time.

**Line variation:**  $< \pm 1 \times 10^{-7}$  for 10% change from nominal.

**Output frequency:** 10 MHz,  $\geq 2.4$  V square wave (TTL compatible) 1.5 p-p V into 50  $\Omega$  available from rear panel BNC.

**External time base:** requires 10 MHz, 3.0 V p-p sine wave or square wave into 1 k $\Omega$  via rear panel BNC connector. Switch selects either internal or external time base.

# ELECTRONIC COUNTERS

## Microwave Counter/Power Meter (cont'd)

### Counter Specifications

#### Input 1

**Frequency range:** HP 5347A: 500 MHz - 20.0 GHz  
HP 5348A: 500 MHz - 26.5 GHz

#### Sensitivity:

**HP 5347A/48A:** 500 MHz - 12.4 GHz: -32 dBm  
(-35 dBm typical)  
12.4 GHz - 20.0 GHz: -27 dBm  
(-32 dBm typical)

**HP 5348A:** 20.0 GHz - 26.5 GHz: -20 dBm (-27 dBm typical)

**Maximum input:** +7 dBm

**Damage level:** +25 dBm, peak

**Connector:** HP 5347A: N(f)  
HP 5348A: APC 3.5(m)

**Coupling:** ac

**Accuracy:**  $\pm$ LSD  $\pm$ time base error x frequency  
Accuracy specification applies from 0°C to 50°C when using internal time base, 0°C to 55°C with external time base.

**Resolution:** 1 Hz or 10 kHz, selectable

**Tracking speed:** resolution = 1 Hz, speed = 1 MHz/s  
resolution = 10 kHz, Speed = 1 GHz/s

**Acquisition time:** resolution = 1 Hz, Time < 125 ms  
resolution = 10 kHz, Time < 60 ms

**Maximum deviation:** 20 MHz p-p, automatic mode

**Maximum FM rate:** 10 MHz

**AM tolerance:** any modulation index provided the minimum signal level is not less than the sensitivity specification.

**TCXO time base:** see page 116 for specifications

**External time base:** 10 MHz, 0.7 V min. to 8 V max p-p sine wave or square wave into >1 K $\Omega$  shunted by < 30 pF, via front panel BNC connector.

#### Option 006 microwave level limiter

##### Damage Level

500 MHz - 6 GHz: 39 dBm  
6 GHz - 18 GHz: 36 dBm  
18 GHz - 26 GHz: 34.8 dBm

##### Sensitivity, reduced by:

500 MHz - 12.4 GHz: 3 dBm  
12.4 GHz - 20.0 GHz: 4 dBm  
20.0 GHz - 26.0 GHz: 5 dBm

#### Input 2

**Frequency range:** 10 Hz - 525 MHz

**Sensitivity:** 25 mV rms (15 mV rms typical)

**Impedance:** 1 M $\Omega$  nominal shunted by < 70 pF (10 Hz - 80 MHz) or 50 $\Omega$  nominal (10 MHz - 525 MHz)

**Maximum input:** +10 dBm (50 $\Omega$  input), 1 V rms (1 M $\Omega$  input)

**Connector:** BNC (f)

**Coupling:** ac

**Resolution:** 1 Hz or 10 kHz, selectable

### Power Meter Specifications

**Frequency range:** 10 - 26.5 GHz, sensor dependent

**Power range:** -70 dBm - +20 dBm (100 pW - 100 mW), sensor-dependent

**Power sensors:** HP 8481A, HP 8481D, HP 8484A, HP 8485A  
The HP 8481D is a direct replacement for the HP 8484A

**Dynamic range:** 50 dB in 10 dB steps

**Display units:** Watts, dBm

**Resolution:** 0.01 dB in logarithmic mode, 0.1 % of full scale in linear mode.

#### Accuracy

**Instrumentation:**  $\pm$ 0.02 dB or  $\pm$ 0.5%

**Zero Set (digital setability of zero):**  $\pm$ 0.5 % of full scale on most sensitive range

#### Power reference

**Power output:** 1.00 mW. Factory set to  $\pm$ 0.7 % traceable to U.S. National Institute of Standards.

**Accuracy:**  $\pm$ 1.2% worst case ( $\pm$  0.9% RSS) for one year.

### General

**Diagnostics:** rear panel or HP-IB selectable, service diagnostics and user information

**Data output:** 90 measurements per second, counter -varies with frequency

(10 kHz resolution, DUMP MODE)

18 measurements per second, power meter

**HP-IB Interface Functions:** SH1, AH1, T5, L4, SR1, RL1, DC1, DT1, E1 (see page 578)

**Operating temperature:** 0°C to 55°C

**Power requirements:** 50 VA maximum

**Line select:** 100V (90 - 105Vac rms; 47.5 440 Hz);  
115/120V (104 - 126Vac rms; 47.5 -440 Hz);  
220V (198 - 231Vac rms; 47.5 - 66 Hz);  
230/240V (207 -252Vac rms; 47.5 -66 Hz)

**External dc:** 12 to 26Vdc, 40 W, binding post

**Battery (Option 002):** 1-2 hours of operation (typical), 12 hours to charge (typical)

**Accessories supplied:** power cord, Operating/Programming Manual, power sensor cable (HP 11730)

**Size:** 144 H x 325 W x 456 D (5.66" x 12.8" x 18.0")

**Weight:** 9.1kg (20lb); with battery, 10.4kg (23lb)

### Ordering Information

HP 5347A 20 GHz Counter/Power Meter

HP 5348A 26.5 GHz Counter/Power Meter

#### Options for HP 5347A and HP 5348A

Opt 002 Battery Pack	+ \$400
Opt 006 Microwave Level Limiter	+ \$950
Opt 011 HP-IB Interface	+ \$300
Opt 070 Soft Carrying Case	+ \$295
Opt 913 Rack Mount Kit	+ \$390
Opt 915 Service Manual	+ \$150
Opt 916 Addition Operating/Programming Manual	+ \$75
Opt W30 (HP 5347A) Extended repair service. See page 723.	+ \$190
Opt W30 (HP 5348A) Extended repair service. See page 723.	+ \$215
Opt W32 (HP 5347A/48A) Calibration service. See page 723.	+ \$870

#### Power sensors

HP 8481A Power sensor	\$650
HP 8481D Power sensor	\$900
HP 8484A Power sensor	\$1,000
HP 8485A Power sensor	\$950

#### HP Power sensor cables

HP 11730A 1.5 meters (5 ft) sensor cable	\$90
HP 11730B 3.0 meters (10 ft) sensor cable	\$100
HP 11730C 6.1 meters (20 ft) sensor cable	\$140
HP 11730D 15.2 meters (50 ft) sensor cable	\$200
HP 11730E 30.5 meters (100 ft) sensor cable	\$265
HP 11730F 61.0 meters (200 ft) sensor cable	\$425

#### Additional equipment available:

Transit Case 9211-2650

(See page 712)

☎ For same-day shipment, call HP DIRECT at 800-538-8787.

**Five Function Keys Simplify Operation**

Extra functions that can get in the way of making quick and easy power and frequency measurements, were designed out of the HP 5347A and HP 5348A counter/power meters. As a result, only five function keys are required to make accurate frequency and power measurements. With only five keys, the chances of getting an incorrect reading due to instrument set-up is almost eliminated.

You will find that little or no time is required to learn how to use these instruments. And, in case it is needed, a one-page guide for getting started is shipped with every instrument.

**No Need for Calibration Tables**

Average calibration tables have already been entered for you in the HP 5347A and HP 5348A. They are permanently stored in memory. You no longer need to spend valuable time trying to correctly enter power sensor calibration tables. Using average calibration tables results in only a slight reduction in overall measurement accuracy.

With the HP 5347A and 5348A, you do not need to enter the frequency used to make a power measurement. Simply take advantage of the built-in frequency counter to measure frequency. With the press of a single key, the frequency measurement is stored for use in the power measurement. The stored frequency is then used to access the power sensor calibration factor in the permanently stored calibration factor versus frequency tables.



One easy-to-use instrument makes the job quicker and more convenient.



The internal battery allows measurements without cumbersome electrical cords.

**Internal Battery for Cordless Measurements**

An optional internal battery allows you to make cordless measurements for up to two hours. When you are in the field, you do not need a power cord. Just walk right up to the output port and make your measurement.

An external dc input is available for even greater flexibility in choosing a power source. At times it might be more convenient to operate the instrument from a dc supply.

**A Rugged Package for Tough Environments**

These instruments are designed to survive the harsh transportation and operation environments common to portable applications. Their membrane front panels keep dirt and moisture from entering the instruments. An optional soft carrying case stores accessories, protects the unit during transit, and frees your hands to make measurements.

**For Benchtop and ATE Systems Too**

You will find that having frequency and true power measurements in a single portable package saves valuable bench space in a manufacturing environment. The ease-of-use features will also be greatly appreciated.

A rackmount kit and HP-IB option are available for using the HP 5347A or HP 5348A in an ATE system.



# ELECTRONIC COUNTERS

## Microwave Counter/Power Meter

HP 5347A, 5348A

- Quick and easy power and frequency measurements
- Portable
- Battery operation
- Built-in sensor calibration tables
- Supports HP's power sensors



HP 5348A with optional soft carrying case and HP 8485A power sensor

### HP 5347A and HP 5348A Microwave Counter/Power Meter

The HP 5347A and HP 5348A microwave counter/power meters offer the convenience of a single instrument that meets both your frequency and power measurement needs. The HP 5347A counter/power meter makes these measurements to 20 GHz, and the HP 5348A to 26.5 GHz. Both counter/power meters offer the accuracy and resolution that previously required a stand-alone counter and a separate power meter.

Measurements are easy. The HP 5347A and 5348A are designed for ease of use; they have only five function keys. They are rugged, lightweight, and battery powered.

#### True Power Meter Performance

As a power meter, the HP 5347A and 5348A offer excellent dynamic range, linearity, and accuracy. They use the same proven power sensors used with Hewlett-Packard's stand-alone power meters. Power sensors and accurate, wide range measurements go hand in hand.

Power measurements can be made from  $-70$  dBm to  $+20$  dBm over a 10 MHz to 26.5 GHz frequency range, depending on the sensors used. Exceptional power meter linearity and low sensor SWR combine to give you outstanding measurement accuracy. The instrumentation accuracy is  $\pm 0.5\%$  in linear mode or  $\pm 0.02$  dB in logarithmic mode, making power meter uncertainty a negligible part of your total measurement error.

#### Outstanding Frequency Measurements

The frequency counter offers performance that rivals Hewlett-Packard's highest performance, stand-alone CW microwave counters. The HP 5347A measures frequency from 10 Hz to 20 GHz, and the HP 5348A from 10 Hz to 26.5 GHz. You can select either 1 Hz or 10 kHz resolution while measuring signals down to  $-35$  dBm.

#### Portable, Easy-to-Use

The HP 5347A and 5348A come in a rugged, lightweight, and portable package. Several features have been designed-in for quick and easy, portable measurements. An internal battery option, for example, provides up to two hours of cordless measurements.

#### Designed for Measurement Ease

How many times have you purchased test equipment only to find that you never use most of the available functionality? The excess functionality only clutters the front panel and makes measurements difficult. Hewlett-Packard recognizes the importance of quick and easy measurements to field service personnel. The HP 5347A and HP 5348A are designed for ease of use.

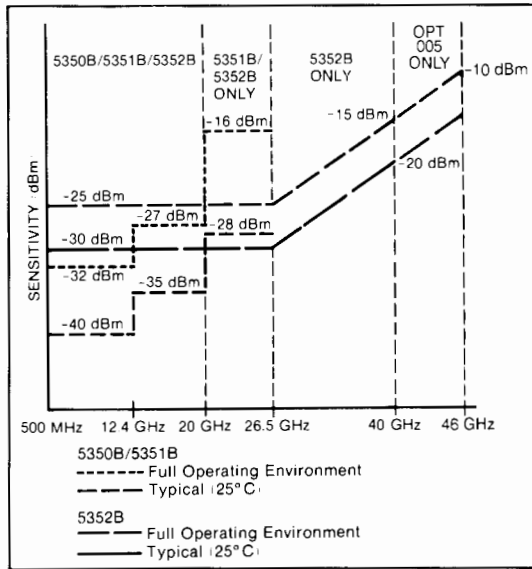

Graph 1. Sensitivity

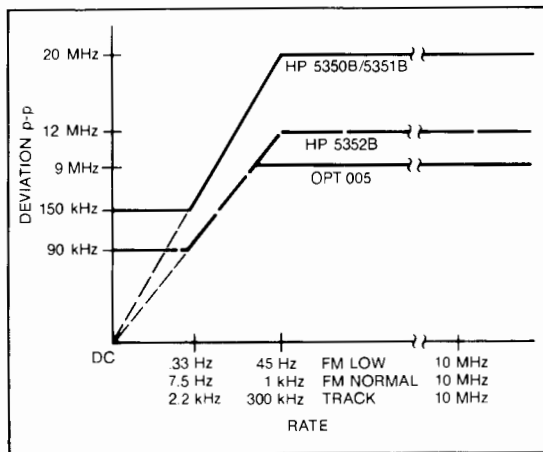

Graph 2. FM Rate Tolerance

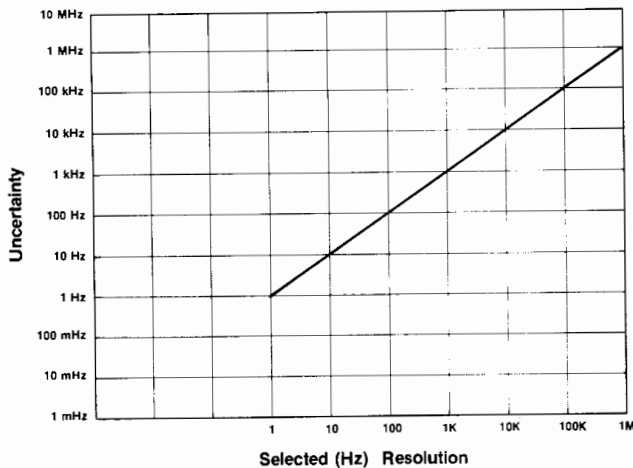

Graph 3. Input 1 uncertainty due to selected resolution

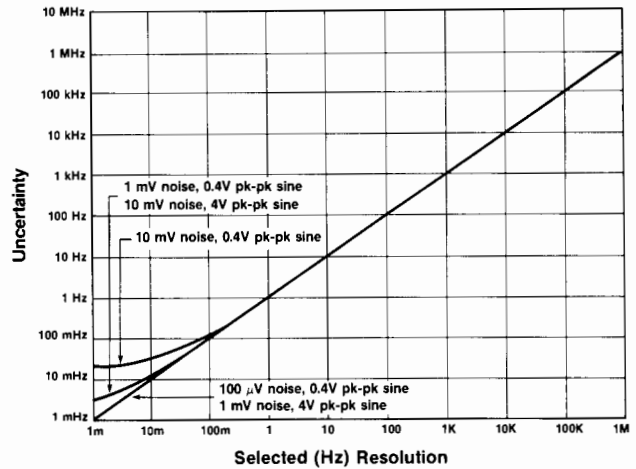

Graph 4. Input 2 uncertainty due to selected resolution and trigger error.

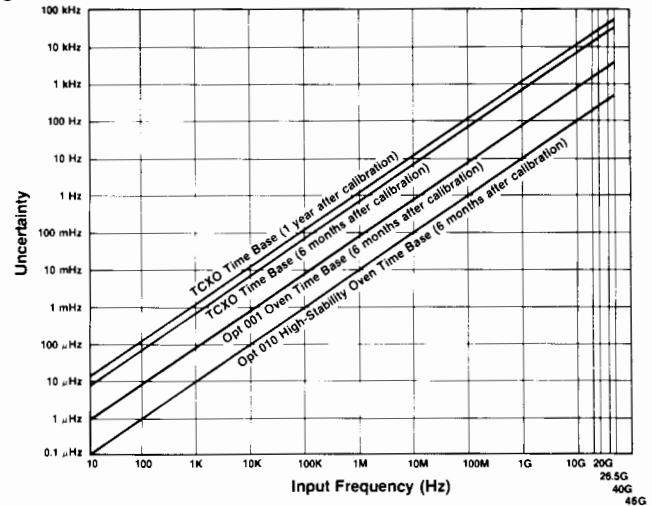

Graph 5. Uncertainty due to time-base error. Time-base error can be reduced by calibrating the time base more frequently, or by using a time base with a slower aging rate.

**Ordering Information**

<b>HP 5350B</b> 20 GHz Microwave Frequency Counter	<b>Price</b> \$5,500
<b>HP 5351B</b> 26.5 GHz Microwave Frequency Counter	\$6,600
<b>HP 5352B</b> 40 GHz Microwave Frequency Counter	\$10,000
<b>Opt 001</b> Oven Time Base	+\$750
<b>Opt 002</b> Rear Panel Inputs (HP 5350B/51B only)	+\$300
<b>Opt 005</b> Frequency Extension to 46 GHz (HP 5352B only)	\$3,900
<b>Opt 006</b> Microwave Level Limiter (HP 5350B/51B only)	+\$700
<b>Opt 010</b> High Stability Oven Time Base	+\$1,500
<b>Opt 700</b> MATE Programming	\$500
<b>Opt 910</b> Additional Operating & Service Manual	+\$75
<b>Opt 908</b> Rack Mount Kit for use with front handles removed	+\$32.50
<b>Opt 913</b> Rack Mount Kit for use with supplied front handles	+\$35
<b>Opt 1A3</b> Bellcore CLEI Barcode Sticker	+\$30
<b>Opt W30</b> Extended repair service. See page 723.	+\$160

**Additional Equipment Available:**

- Transit Case (HP 9211-2643)
  - Waveguide (3" straight) adapter WR28-APC3.5 (HP 05356-20217)
  - Waveguide (3" straight) to coaxial adapter WR42-APC3.5 (HP 05356-20216)
  - Adapter - In series APC 3.5 Male to Male (HP 1250-1748)
  - Adapter - In series APC 3.5 Female to Female (HP 1250-1749)
- ☎ For same-day shipment, call HP DIRECT at 800-538-8787.

# ELECTRONIC COUNTERS

## High-Performance CW Microwave Frequency Counters (cont'd)

### HP 5350B/5351B/5352B Specifications

#### Input 1

**Frequency range:** HP 5350B: 500 MHz to 20 GHz  
 HP 5351B: 500 MHz to 26.5 GHz  
 HP 5352B: 500 MHz to 40 GHz  
 Option 005: 500 MHz to 46 GHz

**Sensitivity**, in dBm (specification/typical performance @ 25°C)

**HP 5350B/5351B: 500 MHz to 12.4 GHz:** -32/-40; Option 002: -31/-39; Option 006: -29/-37.

**HP 5350B/5351B: 12.4 GHz to 20 GHz:** -27/-35; Option 002: -25/-33; Option 006: -23/-31.

**HP 5351B: 20 GHz to 26.5 GHz:** -16/-28; Option 002: -13/-25; Option 006: -11/-23.

**HP 5352B: 500 MHz to 26.5 GHz:** -25/-30; 26.5 GHz to 46 GHz, linear decrease to -10/-15.

**Maximum input:** +7 dBm.

**Damage level:** +25 dBm; HP 5350B/5351B Option 006: 500 MHz to 6 GHz + 39 dBm; 6 GHz to 18 GHz + 36 dBm; 18 GHz to 26.5 GHz + 34.8 dBm.

**SWR (typical):** 500 MHz to 10 GHz 2:1; Option 002/006 2.5:1.  
 10 GHz to 26.5 GHz 3:1; Option 002/006 3.5:1.  
 26.5 GHz to 46 GHz 3.5:1.

**Coupling:** dc to 50Ω termination, ac to instrument.

**Connector:** Precision Type N female (HP 5350B)  
 APC-3.5 male with collar (HP 5351B/HP 5352B)  
 APC-2.4 male with collar (Option 005)

**Accuracy:** ± 1 LSD ± time-base error × frequency; see graphs 3, 5.

**Residual stability:** when counter and source use common 10 MHz time base or counter uses external higher stability time base, .3 LSD rms typical for resolution 1 Hz - 1 kHz at 25°C; HP 5352B .7 LSD typical 26.5 - 40 GHz; LSD = least significant digit.

**Resolution:** selectable 1 Hz to 1 MHz.

**FM Tolerance** (see Graph 2: FM Rate Tolerance)

**Maximum deviation:** Auto 20 MHz p-p (HP 5350B/HP 5351B)  
 12 MHz p-p (HP 5352B)  
 9 MHz p-p (Option 005)  
 Manual: 60 MHz p-p (HP 5350B/HP 5351B)  
 55 MHz p-p (HP 5352B)  
 55 MHz p-p (Option 005)

**Maximum FM rate:** 10 MHz.

#### Tracking Speed

**Fast-acquisition track:** 1 GHz/s.

**Normal FM rate:** 1 MHz/s.

**Low FM rate:** 80 kHz/s.

**AM tolerance:** any modulation index provided the minimum signal level is not less than the sensitivity specification.

#### Modes of Operation

**Automatic:** counter automatically acquires and displays highest level signal within sensitivity range.

**Manual:** center frequency must be entered to within ± 20 MHz or input frequency; ± 3 MHz worst case below 1 GHz; increases measurement and data output rate.

**Automatic amplitude discrimination:** automatically measures the largest of all signals present, providing that signal is >6 dB (typical) above any signal within 500 MHz; >20 dB (typical) above any signal within 500 MHz to 20 (46) GHz.

#### Acquisition time

**Automatic mode:** fast-acquisition track: <60 ms.  
 normal FM rate: <125 ms.  
 low RM rate: <1.25 s

**Manual mode:** <20 ms.

	TCX0	Option 001	Option 010
Aging Rate	1 X 10 <sup>-7</sup> per month	5 X 10 <sup>-10</sup> per day	2 X 10 <sup>-8</sup> per year
Short Term	1 X 10 <sup>-9</sup> per s	1 X 10 <sup>-10</sup> per s	1 X 10 <sup>-10</sup> per s
Temperature 0 - 50	1 X 10 <sup>-6</sup>	1 X 10 <sup>-9</sup>	1 X 10 <sup>-9</sup>
Line 10% change	1 X 10 <sup>-7</sup>	1 X 10 <sup>-10</sup>	1 X 10 <sup>-10</sup>
Warm up to <5 X 10 <sup>-9</sup> @ 25°C		10 minutes	10 minutes

Time Base (10 MHz).

#### Input 2

**Frequency range:** 10 Hz to 525 MHz.

#### Mode of Operation

**50Ω:** 10 MHz to 525 MHz.

**1MΩ:** 10 Hz to 80 MHz.

**Sensitivity:** full operating environment:

**50Ω:** 10 MHz to 525 MHz, 25 mV rms: 15 mV typical @ 25°C;

**1MΩ:** 10 Hz to 80 MHz, 25 mV rms: 15 mV typical @ 25°C;

Gate Time = 1/resolution: 1 ms minimum.

**Resolution:** selectable 1 Hz to 1 MHz.

**High resolution:** 1MΩ mode: 0.001 Hz for <100 kHz input; 0.01 Hz for <1 MHz input; 0.1 Hz for <10 MHz input; 1 Hz for >10MHz input: 1 second gate.

**Accuracy:** (See Graphs 4 & 5). ±1 LSD

$$\left( \frac{\pm 1.4 \times \text{Trigger Error}^{(1)} \pm \text{Time Base}}{\text{Gate Time}} \right) \times \text{Frequency}$$

**Impedance:** selectable 1M Ω nominal shunted by <70 pF or 50 Ω nominal.

**Coupling:** ac.

**Connector:** replaceable fuse, type BNC female.

**Maximum input:** 50Ω: +10 dBm; 1M Ω: 1V rms.

**Damage level:** 50Ω or 1MΩ dc - 5 kHz: 250 V (dc + ac peak); >5 kHz: 5.5 V rms (+ 28 dBm) + 1.25 X 10<sup>6</sup> V rms/FREQ.

**Panel label:** 5.5 V rms (+ 28 dBm).

**Time base output:** 10 MHz and 1 MHz, 2.4 V square wave ac coupled into 1kΩ: 1.5V p-p into 50Ω; available from rear panel BNC connectors whenever the instrument has ac power connected.

**External time base:** 1, 2, 5 or 10 MHz, 0.7 V min to 8 V max. p-p sine wave or square wave into > 1KΩ shunted by < 30 pF, via rear-panel BNC connector. External reference automatically selected when signal is present.

#### General

**Display:** segmented 24-character alphanumeric LCD (backlighted).

**Keyboard:** set-up stored in STBY mode.

**Self-check:** tests for correct circuit operation.

**Diagnostics:** front-panel or HP-IB selectable, Display and Keyboard Lockout, Service Diagnostics and User Information.

**Data output:** over HP-IB bus; varies with Frequency and Resolution.

**Auto mode:** >100 readings/s, 10 kHz resolution, no math functions, "DUMP" mode.

**Manual mode:** >120 readings per second formatted at 10 kHz resolution, no math functions "DUMP MODE".

**Math functions:** result = measurement x scale + offset.

**Offset:** measurement is offset by entered value.

**Scale:** measurement is multiplied by entered value.

**Smooth:** displayed resolution is determined using exponential averaging; displays only stable digits.

**Sample rate:** variable from less than 50 ms between measurements to HOLD, which holds the display indefinitely or until trigger occurs.

**Display rate:** 5/s, variable over HP-IB.

**Overload indication:** "OVRLOAD" A user message.

**Sleep mode:** input 1 emissions reduced to <-70 dBm typical when sleep mode or input 2 is selected.

**IF output:** rear panel BNC provides 30 - 110 MHz down-converted microwave signal at >-20 dBm into 50 Ω, ac coupled.

**HP-IB interface functions:** functions and diagnostics are programmable; address-set at front panel, default switches on rear panel; teach/learn programming; IEEE 728 compatible command structure; function subset SH1, AH1, T5, L4, SR1, RL1, PP0, DC1, DT1, C0, E1 (see page 574).

**Reset/local:** returns to local control.

**Operation temperature:** 0° C to 50° C.

**Power requirements:** 100 VA max.

**Line select:** 100 V (90-105 Vac rms; 47.5 - 440 Hz).  
 115/120 V (104/126 Vac rms; 47.5 - 440 Hz).  
 220 V (198-231 Vac rms; 47.5 - 66 Hz).  
 230/240 V (207-252 Vac rms; 47.5 - 66 Hz).

**Accessories furnished:** power cord, manual.

**Size:** 133H × 425 W × 358 mmD (5¼" × 16¾" × 14")

**Weight:** 11 kg (24 lb).

(1) Trigger Error  $\sqrt{e_1^2 + e_n^2}$  s rms

Input Slew Rate in V/s at Trigger Point

Where  $e_1$  = effective rms noise of counter's input channel (100 μV typical)

$e_n$  = rms noise of the input signal for a 500 MHz bandwidth

# ELECTRONIC COUNTERS

Our Newest, High-Performance CW Microwave Frequency Counters

HP 5350B, 5351B, 5352B

115

- Frequency coverage from 10 Hz to 46 GHz, without an external mixer
- 2.4 mm connector available with Option 005
- Exceptional sensitivity to  $-40$  dBm
- 1 GHz/second tracking speed
- 60-millisecond acquisition time
- 100 measurements/second over HP-IB in automatic mode
- Two years of extended hardware support with Option W30

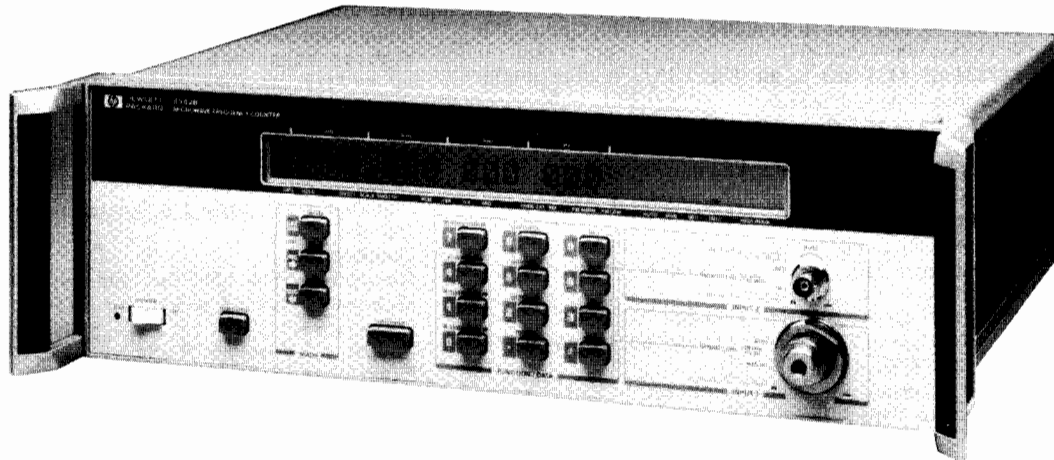

DESIGNED FOR  
MATE  
SYSTEMS

The HP 5352B, shown above, is a member of the new HP 5350 CW microwave counter family

## HP 5350B/5351B/5352B Microwave Frequency Counters

The HP 5350B/5351B/5352B are automatic CW Microwave Frequency Counters that measure to 20, 26.5, and 46 GHz respectively. With resolution as fine as 1 Hz, these counters provide you with fast and precise frequency measurements.

By integrating all microwave components onto a single hybrid GaAs circuit, these counters offer you high performance at low prices. Wide frequency coverage, exceptional sensitivity, fast tracking speed, high measurement throughput, and wide FM tolerance are but a few of the high-performance features that you get with these low-cost counters.

With a built-in microprocessor, the HP 5350B/5351B/5352B also have math capabilities such as measurement scaling and offset. These functions are useful when you need indirect measurement results. Also, automatic amplitude discrimination automatically measures frequency of the highest-amplitude signal in a multi-signal environment. Other convenience features include diagnostic routines that let you perform tests on the counter for general information and troubleshooting.

The HP 5350B/5351B/5352B are ideal components for test systems. They are easy to program and their English-like commands simplify systems integration by reducing your programming effort. Their high measurement throughput also saves you money by reducing test time. In automatic test systems, the programmable alphanumeric liquid-crystal display (LCD) can serve as a message center; and if operational security is a concern, keyboard and display lockout can be activated. In noise-sensitive environments, you can put these counters in the SLEEP mode to reduce kickback noise to as low as  $-70$  dBm.

### Direct Inputs to 46 GHz, Providing Low-cost Solutions for your Expanding Needs

The HP 5350B/5351B/5352B provide a full range of high-performance, low-cost products to meet your expanding measurement needs. The HP 5350B and HP 5351B measure frequency from 10 Hz to 20 GHz and 26.5 GHz respectively. The HP 5352B, which extends input capability to 40 GHz (46 GHz with Option 005), now lets you make measurements in the millimeter-wave range directly – without having to purchase expensive mixers.

### Exceptional Sensitivity, Making Direct Measurement of Low-Level Signals Possible

As these counters have input sensitivity to  $-40$  dBm ( $-30$  dBm for HP 5352B), accurately measuring your low-energy signals becomes a simple task. For example, you no longer need expensive microwave amplifiers to make low-level measurements. Also, you no longer have to worry about signal attenuation by the probe when you make frequency measurements at different nodes within your circuit. These conveniences simplify measurements in applications such as receiver front-end testing.

### Reduced Acquisition Time, Significantly Improving Your Measurement Throughput

With acquisition time reduced to 60 milliseconds in automatic, fast-acquisition tracking mode (20 milliseconds in manual mode), these high-speed microwave counters can significantly improve your measurement throughput.

In bench-top applications, this high-speed throughput gives you fast measurement response. The liquid-crystal display (LCD) will update measurements rapidly to shorten your evaluation time. For applications that require fast measurement response to source tuning, these counters are ideal solutions.

In systems environments, the counters' fast measurement throughput also contributes to your overall system efficiency. Delivering more than 100 measurements/second over HP-IB in automatic mode, the counters' systems performance saves you money by reducing test time.

### 1 GHz/second Tracking Speed, Accurately Measuring Your Fast-Moving Signals

Fast acquisition also offers you fast tracking speed. With acquisition time below 60 milliseconds, these counters can track source drift to 1 GHz/second effortlessly. For example, in measuring the response of a voltage-controlled oscillator (VCO) to voltage-source tuning, these counters will track the changing frequency rapidly to measure the transfer characteristics.

### Option W30 Provides you with Convenient Service and Support For the Second and Third Year of Ownership

In addition to the one-year service that HP normally provides for all of its instruments, Option W30 gives you two additional years of support at the time of purchase. This optional support reflects HP's commitment to product reliability and customer satisfaction.

# ELECTRONIC COUNTERS

## Accessories

HP 10855A, 10856A

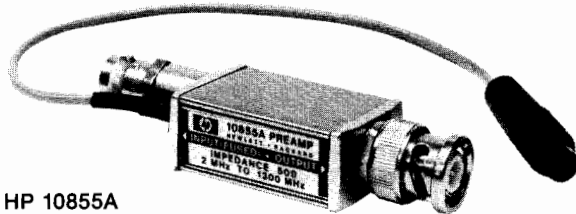

HP 10855A

### HP 10855A 2-1300 MHz Preamp

The HP 10855A Preamp provides a minimum of 22 dB gain from 2 MHz to 1300 MHz to enhance measurements of very low-level signals. The  $\pm 1.5$  dB flat response reduces distortion in non-sinusoidal waveforms. The HP 10855A operates conveniently with a variety of HP measuring instruments having probe power outlets, or will work with the HP 1122A Probe Power Supply. The HP 5334A/5335A Option 030 and HP 5328B Option 031 counters all measure frequency to 1300 MHz and are compatible for use with the HP 10855A.

### HP 10855A Specifications

**Frequency range:** 2 MHz-1300 MHz.

**Gain (minimum):** 22 dB; 24 dB typical.

**Gain flatness across full frequency range:**  $\pm 1.5$  dB.

**Noise figure:** <8.5 dB typical.

Output power for 1 dB gain compression: 0 dBm.

**Harmonic distortion:** -30 dB for -15 dBm output, typical.

Output for <-66 dB harmonic distortion: -25 dBm, typical.

**VSWR:** <2.9, typical.

**Impedance:** 50  $\Omega$  nominal.

**Reverse isolation:** >45 dB.

**Maximum input:** 3.5 V rms (+24 dBm), fuse protected.

### Ordering Information

HP 10855A 2-1300 MHz Preamp

HP 10856A Low Pass Filter Kit

☎ For same-day shipment, call HP DIRECT at 800-538-8787

### Price

\$800 ☎

\$450

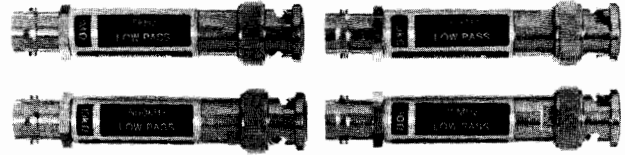

HP 10856

### HP 10856A Low Pass Filter Kit

The four low pass filters of the HP 10856A filter kit are recommended for use with any HP frequency counter to reduce high frequency noise or unwanted signals that cause frequency or period measurement errors. Further applications for the kit include reducing noise (trace fuzz) in oscilloscope and spectrum analyzer displays.

### HP 10856A Specifications

Cut Off Frequency (NOMINAL)	5 KHz	50KHz	500 KHz	15 MHz
Input Impedance (NOMINAL)	1 M $\Omega$	100 k $\Omega$	10 k $\Omega$	50 $\Omega$
Signal Rejection, 100 MHz to 500 MHz	>40 dB	>40 dB	>40 dB	>20 dB

**Roll-off:** 20 dB per decade.

**Attenuation:**  $\times 2$ , reduces signal voltage by a factor of 2.

**Output impedance:** for use with 1 M $\Omega$  input instruments.

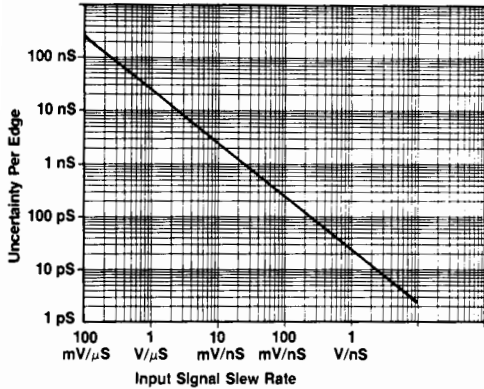

Graph 1. Trigger level timing error varies with input signal slew rate. Uncertainty is associated with both start and stop edges.

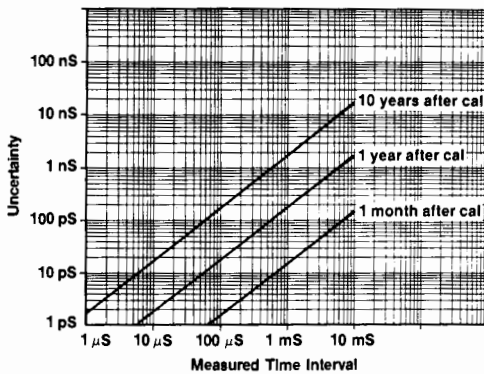

Graph 2. Time base crystal aging affects a time interval or pulse width measurement.

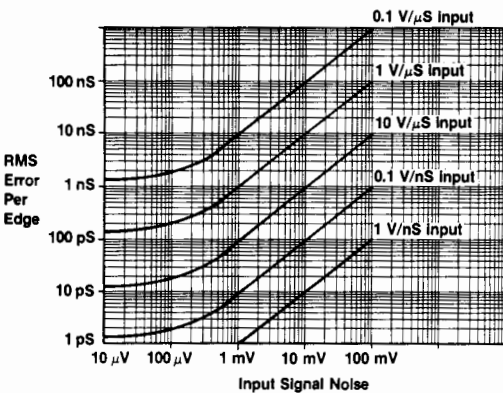

Graph 3. Noise on the input signal will add uncertainty to a time interval measurement. Averaging will reduce the effects of random noise.

**For more information**

Ask your local HP sales representative for the following literature for more details on the HP 5370B Time Interval Counter and the HP J06-59992A Time Interval Calibrator. See page 737 for your local HP sales office.

HP 5370B Technical Data Sheet Literature Number 5952-7915  
 HP J06-59992A Technical Data Sheet Literature Number 5952-7837

**Product Note 5370B-2** "Better than 100 ps Accuracy in HP 5370B Time Interval Measurements Through Bias Error Reduction" Literature Number 5952-7834.

**Product Note 5370B-3** "High Throughput Picosecond Characterization of Pulse Parameters" Literature Number 5952-7769

**Application Note 191-7** "High-Speed Timing Acquisition and Statistical Jitter Analysis" Literature Number 5952-7908.

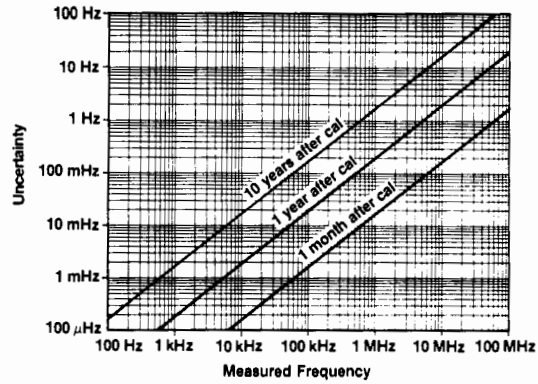

Graph 4. Time base crystal aging affects Frequency and Period measurements. You can further reduce the uncertainty by using an atomic frequency standard.

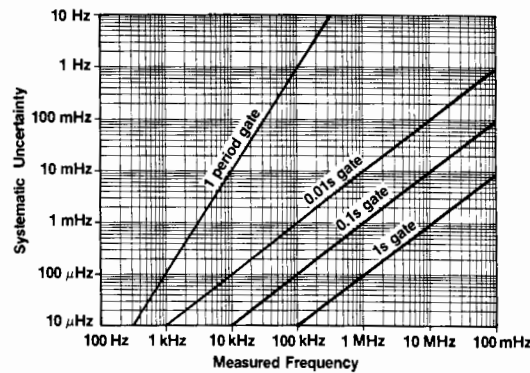

Graph 5. Internal uncertainties affect Frequency and Period measurements.

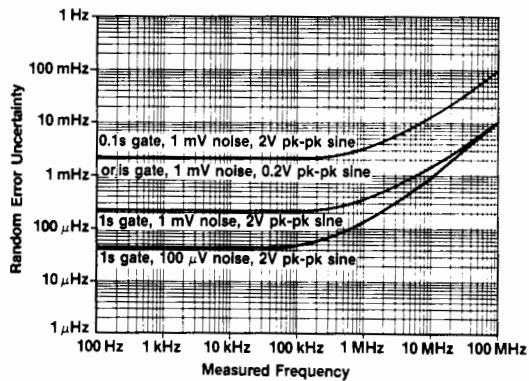

Graph 6. Noise on the input signal will add uncertainty to a Frequency or Period measurement. Longer gate times and averaging will reduce the effects of random noise.

**Ordering Information**

	<b>Price</b>
HP 5370B Time Interval Counter	\$13,300
Opt 913 (5370B Rack Flange Kit - use with supplied front handles)	+ \$30
Opt 908 (5370B Rack Flange Kit - without supplied front handles)	+ \$33
Opt W30 Extended repair service. See page 723.	
Opt W32 Calibration Service. See page 723	
HP 10870A HP 5370B Service Kit Accessory	+\$1,200
HP J06-59992A Time Interval Calibrator	+ \$3,000

# ELECTRONIC COUNTERS

## Universal Time Interval Counter

HP 5370B

- 20 ps single-shot LSD
- $\pm 100$  ps accuracy achievable
- 8000 measurements/s possible
- Built-in statistics functions
- Positive, zero and negative time
- Frequency and period to 100 MHz

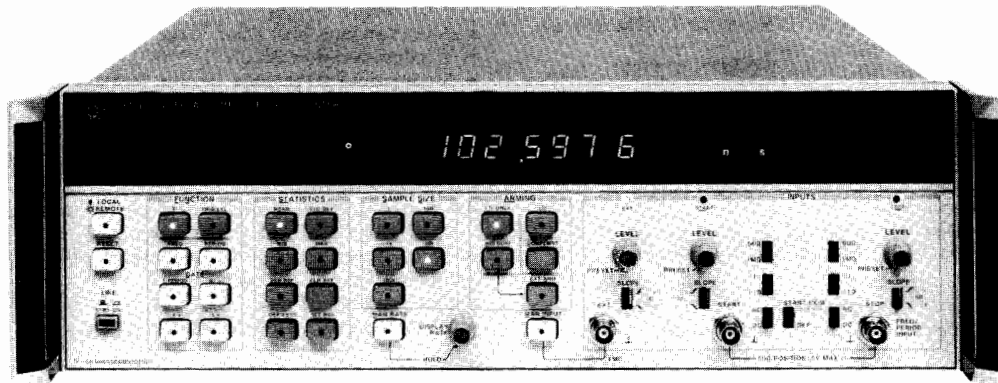

HP 5370B

### Increase Productivity with the HP 5370B's Precision and Measurement Speed

- IC tester performance verification
- Fast IC characterization
- Disk drive manufacture
- Digital communications - jitter analysis
- Radar/laser ranging calibration
- Nuclear systems
- Calibration labs

### Use the full range of functions

**Time Interval:** you can get 20 ps single shot LSD on time intervals from zero to 10 s, including negative time (where the STOP channel event occurs before the START channel event).

**Frequency:** measure up to 100 MHz with 11 digits of resolution in one second. Choose gate times down to one period; use one period with average mode and access the powerful STATISTICS capabilities.

**Period:** measure period average from one to 100k samples and use STATISTICS.

**Statistics:** will reduce your external computations, reduce random errors and improve measurement throughput.

**Sample size:** you can select 1, 10, 1k, 10k or 100k samples from the front panel, or 1 to 65,536 samples over HP-IB. For the selected sample size you can compute:

- Mean
- Standard Deviation
- Minimum
- Maximum

### Select the time interval you want from complex waveforms

Use the extremely flexible arming and gating to select: +TI or  $\pm$ TI with internal arming, external arming - no hold-off, or with external arming - external hold-off.

### Program all major capabilities of the HP 5370B over HP-IB

Data output rates:

- up to 8000 readings/second in fast binary mode - 125  $\mu$ s dead time.
- 10 to 20 readings/second fully formatted - 330  $\mu$ s dead time.

### Time Interval Measurement Characteristics

#### Range

$\pm$ TI: -10 to +10 seconds, including zero.

+TI: 10 ns to 10 seconds.

**Resolution:** measurement resolution will depend on input signal noise and slew rate. Refer to Graph 3 for characteristic curves.

#### Accuracy

Time interval measurement accuracy is influenced by internal systematic uncertainties, trigger level timing error for each trigger edge, and timebase aging in addition to resolution or random uncertainties. Graphs 1 and 2 show characteristic systematic uncertainties for the HP 5370B. These uncertainties may be reduced to less than 10 ps by calibration with the HP J06-59992A Time Interval Calibrator. Careful calibration and averaging will result in accuracies to  $\pm 100$  ps.

#### Frequency and Period Measurement Characteristics

##### Range

Frequency: 0.1 Hz to 100 MHz

Period: 10 ns to 10 seconds

**Resolution:** measurement resolution will depend on input signal noise as well as measurement gate time. Refer to Graph 6 for characteristic curves.

##### Accuracy

Accuracy is influenced by internal uncertainties, timebase aging, and noise on the input signal. Graphs 4 and 5 show the contributions of timebase aging and internal uncertainties to measurement accuracy. Periodic timebase calibration will minimize uncertainty due to timebase aging. Internal uncertainties and noise effects may be reduced by selecting longer gate times, or averaging results.

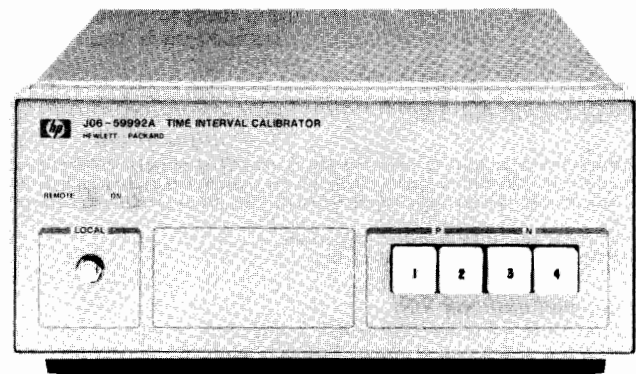

The J06-59992A Time Interval Calibrator gives you the ability to remove systematic errors from your measurement system, so that the 5370B can measure with uncertainties of  $\pm 100$  ps.

## HP 5371A and HP 5372A Performance Summary

### Basic Performance

- Continuous measurements to a 10 MHz Rate (13.3 MHz rate using the HP 5372A fast measurement mode)
- 125 mHz to 500 MHz frequency range. 100 MHz to 2 GHz Channel C (HP 5372A only)
- -4.0 to +4.0 second time interval range, including 0 seconds.
- 150 ps rms single-shot time interval resolution, 10 digits per second frequency resolution.
- 1 ns minimum input pulsewidth
- 2 mV trigger level resolution
- Auto-trigger capabilities
- Selection of input pods: 50Ω, 1 MΩ, or 10 KΩ active.

### Arming and Triggering Capabilities

- Measurement holdoff by time, events, or signal edge.
- Measurement sample by time, events, signal edge, or parity.
- Arm on any of three input channels: external arm, input A, or input B.

### Measurements

Function	Range
Frequency A <sup>1</sup> ,B <sup>1</sup>	125 mHz to 500 MHz 8 kHz to 500 MHz <sup>3</sup>
Frequency C <sup>1</sup> (HP 5372A only)	100 MHz to 2 GHz
Frequency A&B,A&C,B&C,A+B, A+C,B-A,C-A,B+C,C-B, A/B,B/A, A/C,C/A,B/C,C/B	250 mHz to 500 MHz (A and B) 16 kHz to 500 MHz (A and B) <sup>3</sup> 100 MHz to 2 GHz (C)
Period A <sup>1</sup> ,B <sup>1</sup>	2 ns to 8 seconds 2 ns to 131 μs <sup>3</sup>
Period C <sup>1</sup> (HP 5372A only)	500 ps to 10 ns
Period A&B,A&C,B&C,A+B, A+C,B-A,C-A,B+C,C-B, A/B,B/A, A/C,C/A,B/C,C/B	2 ns to 4.0 seconds (A and B) 2 ns to 65 μs (A and B) <sup>3</sup> 500 ps to 10 ns (C)
Totalize A,B,A&B,A+B A-B,B-A,A/B,B/A	0 to 2 <sup>32</sup> -1 events, each channel
Time Interval A,B,A->B,B->A	10 ns to 8.0 seconds 10 ns to 131 μs <sup>3</sup>
Continuous Time Interval A <sup>1</sup> ,B <sup>1</sup>	100 ns to 8.0 seconds 75 ns to 131 μs <sup>3</sup>
± Time Interval A,B,A->B,B->A	-4.0 seconds to +4.0 seconds including 0 seconds -65 μs to +65 μs including 0 seconds <sup>3</sup>
Rise and Fall Time A <sup>2</sup> Positive and Negative Pulsewidth A <sup>2</sup>	1 ns to 100 μs (auto-trigger) 1 ns to 1 ms (auto-trigger)
Duty Cycle A <sup>2</sup>	0% to 100 % for pulsewidths > 1ns and periods < 1ms (auto-trigger)
Phase A rel B, B rel A Peak Amplitudes A,B	0 to >± 360 degrees 1 kHz to 200 MHz, 200 mV p-p to 2V p-p

<sup>1</sup> Maximum sample rate for these measurements is 10 MHz (100 ns), and up to 13.3 MHz (75 ns) using the HP 5372A fast measurement mode. For all other measurements, maximum sample rate is 5 MHz (200 ns) in the normal measurement mode and 7.7 MHz (135 ns) in the fast measurement mode.

<sup>2</sup> Requires 8 ns setup time between each measurement.

<sup>3</sup> Fast Measurement Mode values (HP 5372A only).

### Analysis Features

- Time variation of measurements: frequency vs. time, time interval vs. time, and phase vs. time. Averaged plots of time variation to improve vertical resolution are obtainable using the HP 5372A.
- Histogram
- Fast Time-interval histogram (HP 5372A only, histograms computed at measurement rate)

- Event timing plots
- Limit test
- Statistics: mean, minimum, maximum, standard deviation, variance, rms.
- Allan variance, root Allan variance.
- Window margin analysis (HP 5372A only)
- Modulation parameters: center frequency, peak-peak deviation, modulation rate.

### HP-IB Performance

- Up to 20,000 measurements/second throughput (HP 5371A), 25,000 for HP 5372A (binary format)
- Three output formats: ASCII, floating point, or binary
- English-like HP-IB commands
- Full programmability
- Direct graphics output to printer or plotter

## HP 5364A Microwave Mixer/Downconverter

### Performance Summary

- 2 GHz to 18 GHz input frequency range
- 10 MHz to 500 MHz IF output range
- 2.2 GHz to 18 GHz local oscillator input range
- Built-in manual attenuator
- 73 dB RF input dynamic range for pulse signals, 53 dB for CW signals
- APC 3.5(m) connectors for RF and LO inputs
- <7.5 ns video output risetime
- Less than 1 ns group delay over 500 MHz IF output range

### HP 53700A Continuous Measurement Software

This software consists of compiled subroutines that simplify and speed binary programming with the HP 5371A and HP Series 300 computers. Sample programs demonstrating these routines are included. Software is supported with the HP 5371A only.

### Ordering Information

HP 5371A Frequency and Time Interval Analyzer	\$23,250
HP 5372A Frequency and Time Interval Analyzer	\$28,300

Both the HP 5371A and HP 5372A include 2 HP 54002A 50 Ω input pods. The HP 5372A also includes 1/2 day application consulting.

### Options

<b>Opt 060</b> Rear Panel Inputs (50Ω BNC) for channels A and B. 1 MΩ BNC for external arm. Deletes front panel inputs.	\$0
<b>Opt W30</b> Extended Repair Service. See page 723.	Contact HP
<b>Opt W32</b> Calibration Service. See page 723.	Contact HP
<b>Additional options for HP 5372A only</b>	
<b>Opt 001</b> Delete 1/2 Day Application Consulting	-\$610
<b>Opt 020</b> FastPort Data Output	+\$1,515
<b>Opt 030</b> 2 GHz Channel C (if rear panel input is desired, order opt 090).	+\$2,020
<b>Opt 090</b> Rear Panel Inputs for channels A,B, and C. 1 MΩ BNC for External Arm, 50 Ω BNC for channels A and B, type N connector for C. Deletes front panel inputs.	+\$2,020

HP 5364A Microwave Mixer/Detector	\$13,000
HP 53700A Continuous Measurement Software (Supported with HP 5371A only.)	\$1,200

### Accessories

HP 54001A 1 GHz Miniature Active Probe/Pod (10:1, 10 KΩ)	\$765
HP 54003A 1 MΩ Pod (with 10:1 scope probe)	\$665
HP J06-59992A Time Interval Calibrator	\$3000



# ELECTRONIC COUNTERS

## Frequency and Time Interval Analyzers (Cont'd)

HP 5371A, 5372A

### Select the Frequency and Time Interval Analyzer that Meets Your Needs

Hewlett-Packard offers two Frequency and Time Interval Analyzers to analyze your signals in the Modulation Domain.

Based on the same technology, the HP 5372A is a complete superset of the HP 5371A. The table below summarizes the capabilities of each.

Feature	HP 5371A	HP 5372A
Frequency Range	125 MHz to 500 MHz	125 MHz to 500 MHz
2 GHz Channel C Input	N/A	Optional
Maximum Measurement Rate	10 MHz (100 ns)	10 MHz (100 ns) 13.3 MHz (75 ns)*
Maximum Measurement Memory	1K Front Panel, 4K HP-IB Binary Mode	8K Front Panel and HP-IB
Time Variation Display (Measurements vs. Time)	YES	YES
Averaged Time Variation Display Capability	N/A	YES
Histogram Display	YES	YES
Fast Time-Interval Histogram	N/A	Histograms computed at a 10 MHz rate (13.3 MHz*)
Event Timing Display	YES	YES
Time Deviation Measurement (Timing Jitter)	N/A	YES
Phase Deviation Measurement	N/A	YES
FastPort Interface (direct output of measurement data)	N/A	Optional
Measurements Referenced to External Trigger	N/A	YES
Pre-Trigger Capability	N/A	YES
Time-Interval Detect Capability	N/A	YES
Multiple Blocks Displayed on Time Variation Graph	N/A	YES
Measurement Inhibit Input	N/A	YES
Modulation Parameters (pk-pk deviation, rate, center)	YES	YES
Statistics, Math and Limit Test	YES	YES
Window Margin Analysis	N/A	YES
Adjustable Input Sensitivity	N/A	YES
Direct Output to HP-IB Printer/Plotter	YES	YES
Display Update Rate (100 measurements)	1 update/s	2 updates/s

\*HP 5372A features a fast measurement mode which increases measurement speed to 13.3 MHz (75ns). Note that the maximum time interval in this mode is 131  $\mu$ s.  
N/A=not available

**Powerful Radar Signal Characterization**

Combining the HP 5364A microwave mixer/detector with the HP 5371A or HP 5372A frequency and time interval analyzers, and a local oscillator gives you the ability to extend the modulation domain to 18 GHz.

The HP 5364A microwave mixer/detector is designed to ensure downconversion with minimal distortion and group delay over its 500 MHz IF bandwidth. You can provide your own local oscillator, or you can use an HP source such as the HP 8671A synthesized CW generator, the HP 8673C synthesized signal generator, or the HP 8673E synthesized signal generator. In addition to the IF channel, the HP 5364A provides a video detector output to trigger the HP 5371A or HP 5372A. The video output can also be used to directly measure pulse width, rise and fall time, and PRF/PRI.

Radar chirp-linearity is easily characterized in the modulation domain. The HP 5364A microwave mixer/detector can be used to downconvert the chirp to baseband, maximizing measurement resolution. A frequency vs. time display clearly shows deviation from linearity. The HP 5372A features display-averaging, which can dramatically improve the resolution of measurements on repetitive signals.

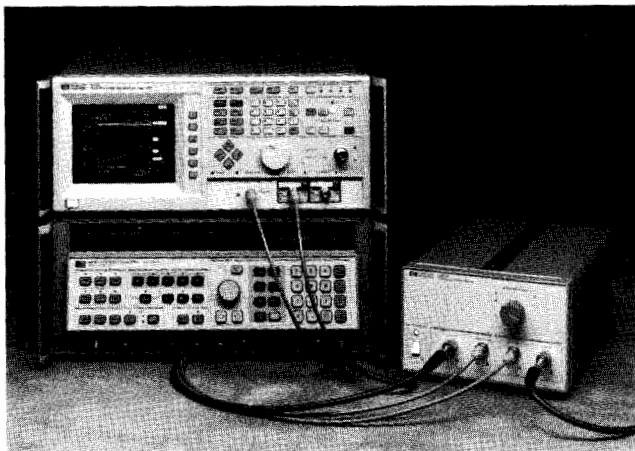

Use the HP 5364A microwave mixer/detector (shown right) with the HP 5371A or HP 5372A to bring the modulation domain to microwave frequencies between 2 and 18 GHz.

**Characterize Motion Control Systems**

Pulse encoders used in motion control systems deliver pulse streams that correspond to position - either linear or rotary. Position and velocity analysis can be done by characterizing the timing of pulses delivered by the encoder.

Continuous time-interval and frequency measurements with the HP 5371A or HP 5372A give you new insight into positioning system performance. Variations in velocity or rotational non-linearities can easily be analyzed by viewing the time variation display; a plot of velocity versus time. For closed-loop systems, factors such as system dampening, overshoot, and response time can be quickly verified - independent of the system's control.

- Rotational or linear velocity vs. time profiles
- Position control analysis
- Analyze dampening, overshoot, and response time

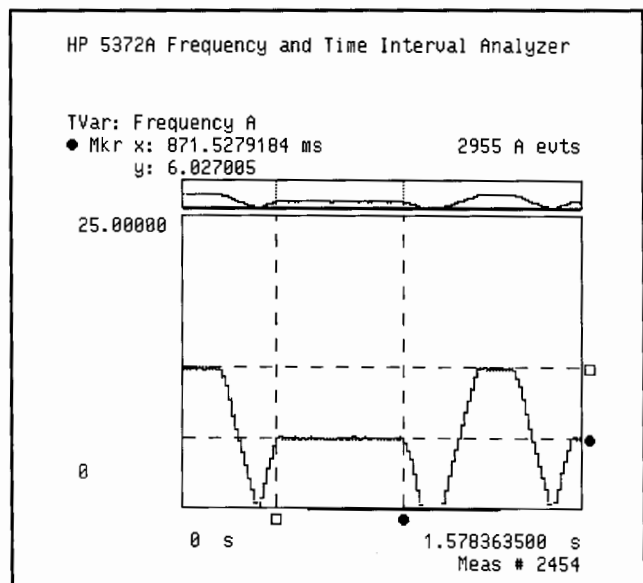

The velocity (frequency) vs time graph allows easy analysis of the print sweep and double-speed return of a motion-control servo used in a graphics printer.

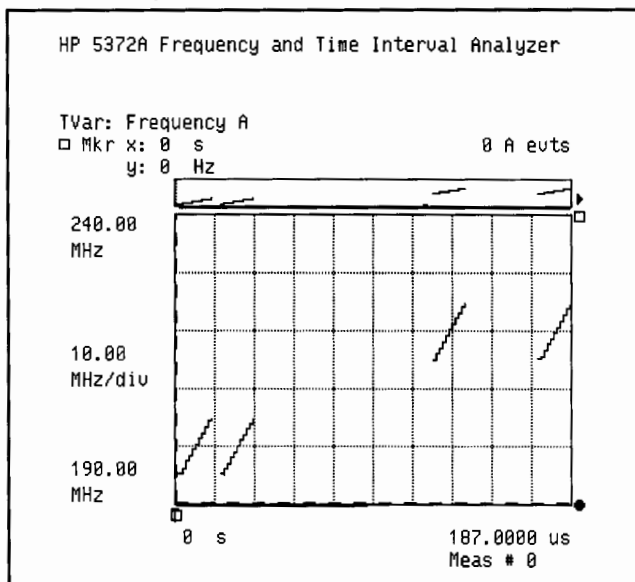

The power of modulation domain analysis can be seen with this HP 5372A frequency vs time graph of a frequency chirp on an agile carrier with a varying PRI.

# ELECTRONIC COUNTERS

## Frequency and Time Interval Analyzers (cont'd.)

HP 5371A, 5372A

### Flexible Jitter Spectrum Analysis for Digital Communications

The HP 5371A and HP 5372A frequency and time interval analyzers can be used to characterize jitter or phase noise in digital communications and other serial data systems. The HP 5371A measures and displays the variations of period jitter with time or in a histogram. The HP 5372A adds the capability to display jitter as the variation of the significant instants from the ideal timing position (time deviation function).

When you add a computer and analysis, you can make jitter spectrum measurements at any clock rate (including non-standard rates) with higher resolution than current jitter test sets. The jitter bandwidth to be examined can be in excess of 2 MHz. In addition to jitter spectrum, jitter transfer function and adjustable weighting filters can be added to processing software to extend system performance. (Analysis software is available from Data Physics Corporation.)

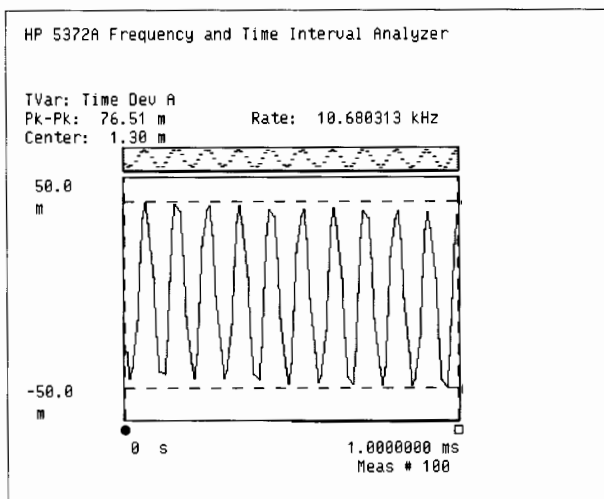

Jitter as a function of time. A strong periodic component can be seen in this jitter vs. time graph. The rate of the jitter is displayed, as well as peak-peak jitter in Unit Intervals.

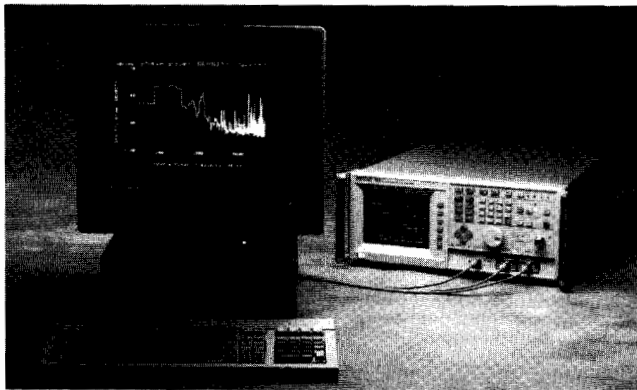

Software available from Data Physics Corporation gives you jitter spectrum and transfer function computations from HP 5371A or HP 5372A data. Weighting filters are also available.

### A Clear Picture of Agile Signals

Characterization of agile transmitters is difficult in the time or frequency domains. Pseudorandom selection of the carrier means repetitive techniques are inadequate to properly characterize an agile radio's performance. 'Golden receiver' or back-to-back testing, where transmitters and receivers are tested in pairs, give little quantitative information about the radio's performance.

The modulation domain provides a clear view of these agile signals. Parameters such as dwell time, hop rate, and carrier settling time can be obtained from the graphic display. Modulation parameters such as peak-to-peak deviation, center frequency, and modulation rate can easily be displayed as well.

A histogram of frequencies is a clear measure of random usage of the frequency spectrum. Flat histogram characteristics indicate that channels are used with equal probability, providing the highest resistance to jamming and communication security.

- Direct frequency vs. time profiles of agile signals
- Characterize switching time, settling time, and hopping rate
- Examine modulation on agile carriers

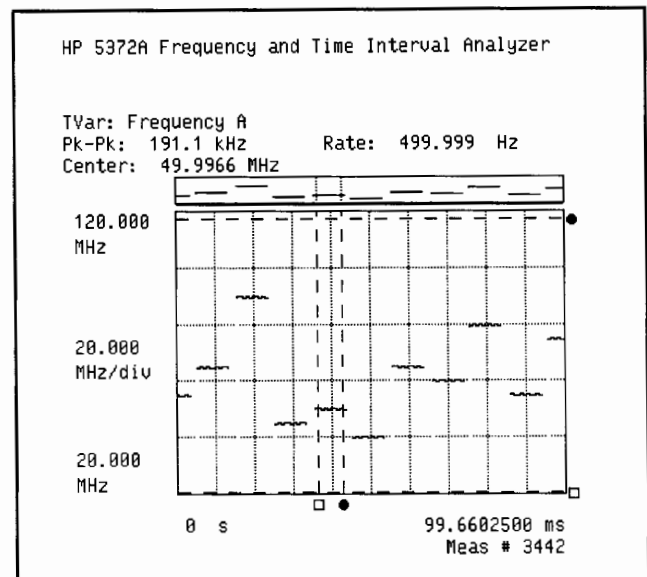

In addition to dwell time and hop sequence, the modulation characteristics on the agile carrier can easily be examined using the HP 5371A or HP 5372A time variation graph.

### Window Margin Analysis for Disk and Tape Drive Characterization

The HP 5372A features hardware data reduction to sort time interval measurements into histograms as fast as 13.3 million measurements per second. You can analyze data as a histogram, or you can have the HP 5372A display window margin information directly. This gives you a fast and accurate method of viewing a drive's overall timing performance in R&D or in production.

You can use the time interval detect capability of the HP 5372A to monitor for timing errors. An inhibit input allows you to gate out sector header, ECC, and servo fields to measure only in data fields.

The HP 5372A can be configured to measure data-to-data as fast as every 75 ns. For faster systems, a random event sampling mode ensures that histogram information is equally sampled across all code spacings.



The HP 5372A displays window margin information directly for disk and tape drive testing.

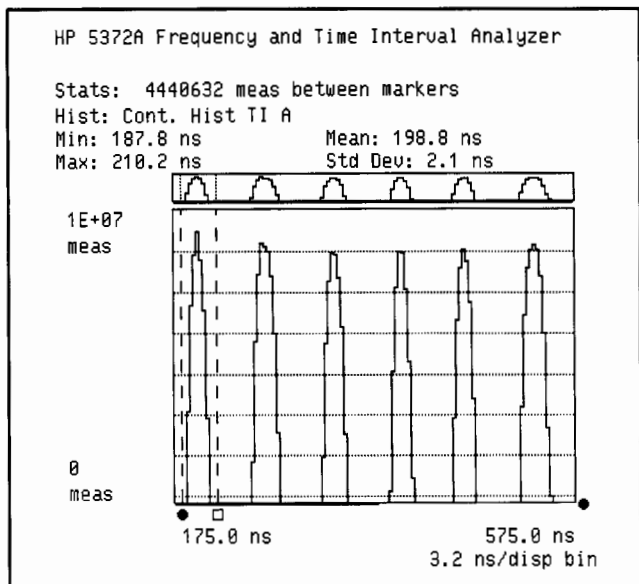

Flexible graphic capabilities let you retrieve statistical information for any single distribution of this RLL (2,7) histogram.

### Direct VCO Characterization With Frequency vs Time Displays

Voltage-controlled oscillators are a key component in many electronic systems. VCO switching and settling characteristics directly affect total system performance. Switching and settling measurements have traditionally been made using discriminators and a storage oscilloscope, but the modulation domain simplifies this characterization by directly showing frequency or phase settling versus time. You can view the step response and easily characterize ringing and overshoot, settling time, and post-tuning drift. The optional 2 GHz Channel C on the HP 5372A extends VCO analysis to cover 100 MHz to 2 GHz frequency steps. The HP 5364A Microwave Mixer/Detector lets you analyze VCO's operating between 2 GHz and 18 GHz.

- Frequency vs. time profiles of VCO switching transients
- Examine settling time, frequency overshoot, and ringing
- Characterize VCO stability and post-tuning drift

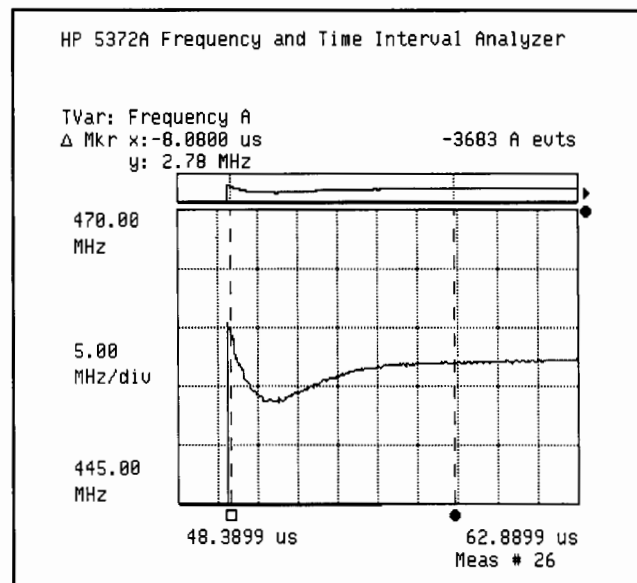

A plot of frequency vs time simplifies VCO switching and post-tuning drift analysis.

# ELECTRONIC COUNTERS

## Frequency and Time Interval Analyzers

### HP 5371A, 5372A

- dc to 18 GHz continuous frequency profiling capability
- Built-in statistical and graphical analysis
- Characterize frequency, phase, and time-interval versus time
- Fast time-interval histogram analysis
- Pre-trigger display and time-interval detect
- 150 ps rms single-shot resolution, 2 ps resolution with averaging



HP 5371A and 5372A

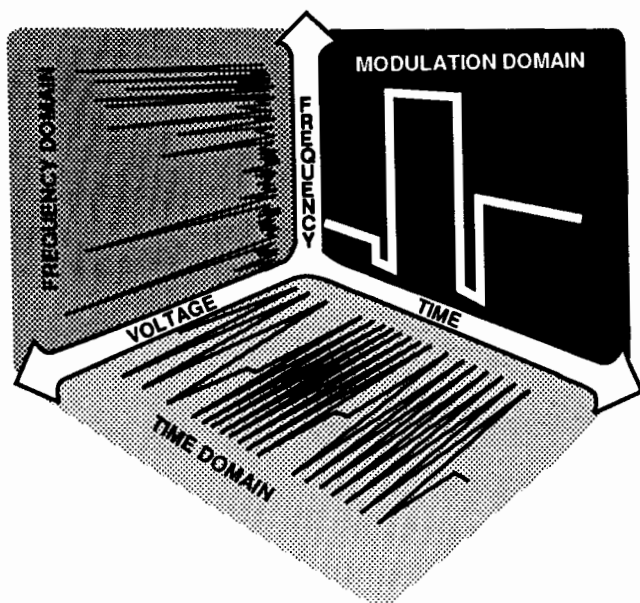

### The Modulation Domain Gives You a New View of Complex Signals

Better ways to analyze your complex signals don't come along often. Hewlett-Packard brings you the Modulation Domain: a view of frequency, phase, or time-interval measurements vs. time. A way of seeing data that is intuitive and insightful. It's the missing piece of the puzzle. The oscilloscope shows you amplitude (voltage) vs. time: the time domain. The spectrum analyzer shows you amplitude vs. frequency: the frequency domain. The HP 5371A and HP 5372A Frequency and Time Interval Analyzers show you measurements vs. time in the Modulation Domain:

- Frequency vs. time
- Phase vs. time
- Time-interval vs. time

### Powerful Insight into Frequency, Phase, or Time Interval Performance

If you need to characterize:

- Data storage products
- Radar systems
- Communication systems
- Electromechanical systems
- Frequency stability
- VCO's
- Frequency agile systems

Hewlett-Packard's frequency and time interval analyzers can show you frequency and timing information that traditional techniques miss.

### Counter Selection Guide

Model	Frequency Range (Extension)	Freq. Resolution (1s Gate Time)	Sensitivity	Time-Interva Res. (Single-Shot/Averaging)	Additional Features	Page	Price
-------	-----------------------------	---------------------------------	-------------	---	---------------------	------	-------

#### Precision Time-Interval

HP 5370B	100 MHz	11 Digits	35 mV	100 ps/0.3 ps	HP-IB standard, statistics	112	\$13,300
----------	---------	-----------	-------	---------------	----------------------------	-----	----------

#### CW Microwave

HP 5350B	20 GHz	1 Hz	-40 dBm		HP-IB standard, MATE optional	115	\$5,500
HP 5351B	26.5 GHz	1 Hz	-40 dBm		HP-IB standard, MATE optional	115	\$6,600
HP 5352B	40 GHz (46 GHz)	1 Hz	-30 dBm		HP-IB standard, MATE optional	115	\$10,000
HP 5343A	26.5 GHz	1 Hz	-33 dBm		HP-IB optional	121	\$12,600
HP 5340A	18 GHz (23.6 GHz)	1 Hz	-35 dBm		HP-IB optional	121	\$18,300

#### CW Microwave/Power Meter

HP 5347A	20GHz	1 Hz	-32 dBm		HP-IB optional, battery optional, -70 dBm to +20 dBm power range	118	\$7,950
HP 5348A	26.5GHz	1 Hz	-32 dBm		HP-IB optional, battery optional, -70 dBm to +20 dBm power range	118	\$8,950
HP 5342A	18 GHz (24.5 GHz)	1 Hz	-25 dBm		HP-IB optional, -25 dBm to +22 dBm amplitude measurement optional	121	\$11,000

#### Pulsed/CW Microwave

HP 5361B	20 GHz	1 Hz	-32 dBm		HP-IB standard, MATE optional, full microwave pulse measurements, automatic pulse profiling	124	\$11,900
HP 5355A	1.6 GHz (110 GHz)	Requires HP 5345A	-25 dBm	Requires HP 5345A	Requires HP 5345A	127	\$10,000
HP 5356A	18 GHz		-20 dBm			127	\$3,100
HP 5356B	26.5 GHz		-20 dBm			127	\$3,100
HP 5356C	40 GHz		-25 dBm			127	\$4,000
HP 5356D	110 GHz		-20 dBm			127	\$10,200

#### RF Frequency

HP 5384A	225 MHz	9 Digits	15 mV		HP-IB standard, battery optional	130	\$1,590
HP 5385A	1 GHz	9 Digits	15 mV		HP-IB standard, battery optional	130	\$1,995
HP 5386A	3 GHz	9 Digits	-33 dBm		HP-IB standard	130	\$3,780

#### Performance Universal

HP 5334B	100 MHz (1.3 GHz)	9 Digits	15 mV	2 ns/200 ps	HP-IB standard, MATE optional, auto pulse characterization	134	\$2,195
VXI E1420A	200 MHz (Opt. High Freq. channel)	9 Digits	25 mV	2 ns/200 ps	VXI-compatibility	624	\$3,450
HP 5335A	200 MHz (1.3 GHz)	9 Digits	25 mV	2 ns/100 ps	HP-IB standard, dc DVM optional, auto pulse characterization	136	\$5,000
HP 5328B	100 MHz (1.3 GHz)	1 Hz	25 mV	10 ns/10 ps	HP-IB standard, dc DVM optional	139	\$6,570
HP 5345A	500 MHz (see HP 5355A/HP 5356A/B/C/D above)	9 Digits	25 mV	2 ns/2 ps	HP-IB standard, MATE optional, microwave measurements via HP 5355A/HP 5356A/B/C/D	132	\$14,650

#### Basic Universal

HP 5314A	100 MHz	1 Hz	25 mV	100 ns	battery optional	143	\$690
HP 5315A	100 MHz (1 GHz)	7 Digits	10 mV	100 ns/10 ps	battery optional	140	\$1,295
HP 5316B	100 MHz (1 GHz)	7 Digits	10 mV	100 ns/10 ps	HP-IB standard	140	\$1,595

#### Accessories

HP J06-59992A	Time-Interval Calibrator	Allows time-interval calibration to remove systematic errors from a measurement system.			112	\$3,000
---------------	--------------------------	---	--	--	-----	---------

# ELECTRONIC COUNTERS

## General Information

### The Modulation Domain Gives You a New View of Complex Signals

Better ways to analyze your complex signals don't come along often. HP brings you the Modulation Domain: a view of frequency, phase or time-interval measurements vs. time. A way of seeing data that is intuitive and insightful.

Modulation Domain is the missing piece of the puzzle. The oscilloscope shows you amplitude (voltage) vs. time: the time domain. The spectrum analyzer shows you amplitude vs. frequency: the frequency domain. The HP 5371A and HP 5372A Frequency and Time Interval Analyzers show you measurements vs. time in the Modulation Domain:

- Frequency vs. time
- Phase vs. time
- Time interval vs. time

### Improve Your Measurement Analysis

A wide range of applications can benefit from this kind of capability.

Jitter measurements in digital communications systems, disk and tape drives, and mechanical systems are dramatically improved. For example, view periodicity in jitter—a hint at the source of the problem.

The Modulation Domain makes it simple to study step response for voltage-controlled

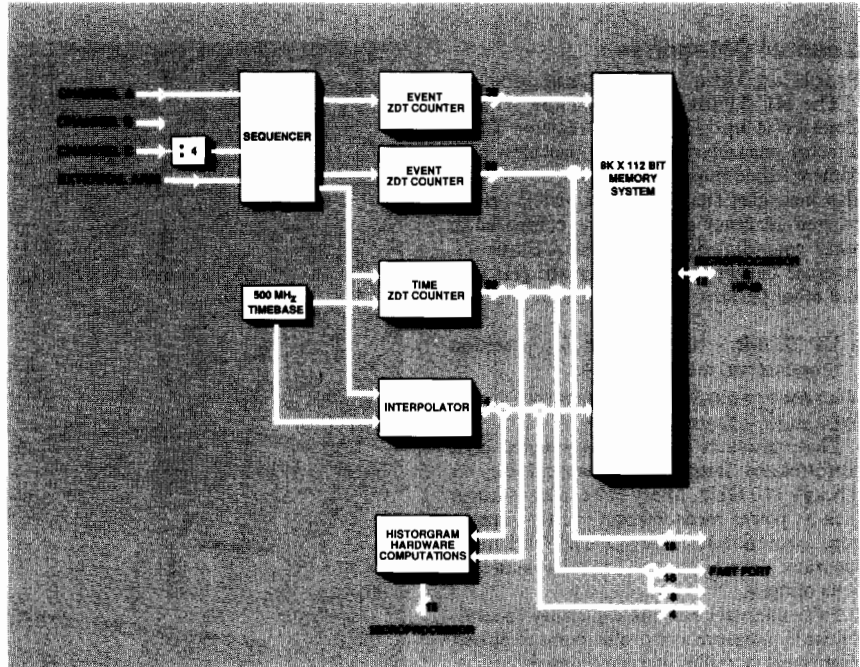

A new approach to the traditional counter block diagram lets the HP 5372A make continuous measurements without a loss of precision.

oscillator characterization. You can easily characterize the frequency hopping performance of an agile transmitter. Chirp linearity and phase switching in radar systems are simplified using frequency or phase vs. time displays.

Discover a new way to see your signals—a new perspective that helps you solve elusive problems or fine-tune product performance. Sharpen your competitive edge with the HP 5371A or HP 5372A.

### Modulation Domain Analyzer Selection Guide

Model	Frequency Range (Extension)	Single-Shot Freq. Res. (1s Gate)	Time-Interval Resolution (Single-Shot/Averaging)	Maximum Continuous Meas. Rate (Meas/s)	Memory Size	Output Result/s	Analysis and Display	Page	Price
-------	-----------------------------	----------------------------------	--	--	-------------	-----------------	----------------------	------	-------

#### Modulation Domain Analyzers

HP 5371A	500 MHz (18 GHz <sup>2</sup> )	10 digits	150 ps/1 ps	10x10 <sup>6</sup>	1000	HP-IB: to 20,000	Frequency and Time vs. Time Graph Software Histogram Event Timing Graph Numeric Display	106	\$23,250
HP 5372A	500 MHz (2 GHz) (18 GHz <sup>2</sup> )	10 digits	150 ps/1 ps	14x10 <sup>6</sup>	8000	HP-IB: to 20,000 Fastport: to 14x10 <sup>6</sup>	As 5371A plus: Hardware Histogram Frequency and Time vs. Time Avg. Pre-Triggering Time Dev. (Jitter) Phase Deviation	106	\$28,300

#### Accessories

HP J06-59992A	Time-Interval Calibrator	Allows time-interval calibration to remove systematic errors from a measurement system.	111	\$3,000
HP 5364A	Microwave Mixer/Detector	Extends measurement range to include 2 to 18 GHz.	111	\$13,000

<sup>2</sup>Requires HP 5364A

## Counter Categories

### Precision Time Interval Counter

The HP 5370B Universal Time Interval Counter is optimized for precision time-interval measurements and provides phenomenal time-interval resolution of 20 ps. It also measures frequency and period (at increased accuracy per unit time compared to other counters) dc to 100 MHz. Statistics, external trigger, systems interface (HP-IB) and other features are all standard.

- **HP 5370B** - the standard for precision time-interval measurements.

### Microwave and Millimeterwave Frequency Counters

These products provide fundamental high performance frequency measurements, dc through 110 GHz. Many enhancing features such as power measurement, battery operation, systems interface (HP-IB), and high-accuracy time bases are available standard or as options.

Pulse counters add the capability to automatically measure and profile burst or pulsed microwave or millimeterwave signals.

Most current microwave and millimeterwave frequency counters:

- **HP 5361B** - the profiling pulsed/CW microwave frequency counter.
- **HP 5347A/5348A** - portable CW microwave plus precision power measurements for telecommunications service.
- **HP 5350B/5351B/5352B** - the CW microwave trio that spans 10 Hz to 46 GHz.

### Basic RF Frequency Counters

These low-cost products provide frequency measurements dc through 3 GHz for bench and systems use. (HP-IB is standard.) The reciprocal (high accuracy) measurement technique is used, battery and extended-accuracy time base are available.

Most current RF frequency counters:

- **HP 5384A** - the economy counter for systems and field service.
- **HP 5385A** - economy, systems, field service and higher frequency too.
- **HP 5386A** - 3 GHz low end, low price, small size.



Hewlett-Packard offers a full range of electronic counters from RF and microwave to basic and high performance universal counters.

### Basic and Performance Universal Counters (Counter/Timers)

Universal counters, sometimes called counter/timers, combine the ability to measure frequency and time intervals. Many models also provide the capability to measure period, ratio, statistics, voltage, and totalize. The higher performance products provide complete, automatic characterization of rise time, pulse width and other signal parameters. Many options such as, frequency extension, voltage measurement, portable battery operation, higher performance time bases, and systems capability (HP-IB) are also available to customize the product to your specific needs.

Most current universal counters:

- **HP 5314A** - an affordable portable.
- **HP 5315A** - the high-performance portable.
- **HP 5316B** - the low-cost systems counter.
- **HP 5334B** - high performance at a moderate price.
- **HP 5335A** - top performance in universal counters.

### For More Information

Selecting a counter can be as simple as making a choice from the Selection Guide on the following pages. However, specific details of your application or characteristics of your signal (such as sensitivity, slew rate, etc.) might affect your selection. Therefore, specific details on each product are presented on the pages following the Selection Guide.

Also, tutorial application notes (Electronic Counter Series) on many important technical issues affecting counters and counter applications are available for your aid in selection. These application notes will increase your knowledge about counters and your confidence in selecting the right product for your application.

#### Application Note AN 200

"Fundamentals of Electronic Counters"

#### Application Note AN 200-1

"Fundamentals of Microwave Frequency Counters"

**Application Note AN 200-2** (information on counter time bases)

"Fundamentals of Quartz Oscillators"

#### Application Note AN 200-3

"Fundamentals of Time Interval Measurements"

#### Application Note AN 200-4

"Understanding Frequency Counter Specifications"



# ELECTRONIC COUNTERS

## General Information

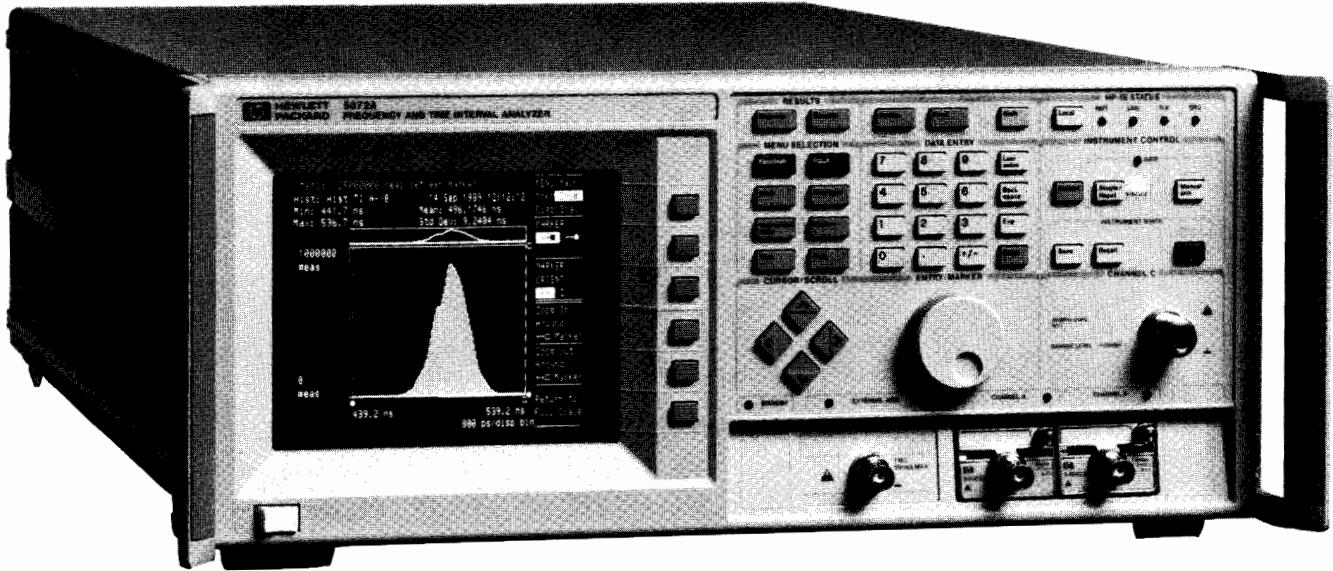

The HP 5372's revolutionary Modulation Domain technology is HP's most recent breakthrough in frequency, phase and time interval measurement and analysis.

### Electronic Counters - Introduction

Hewlett-Packard offers the broadest line of electronic counters and counter/timers (27 models) in the industry. From the beginning of counting in the 1940's Hewlett-Packard has pioneered the major technologies that make possible today's modern electronic counters and frequency and time interval analyzers.

#### Applications

The use of various types of electronic counters for measuring and analyzing frequency, phase and time interval signal characteristics is common in most technical industries. The opportunity to choose from 27 different products to find the optimum product for a specific application will result in your best and most cost effective solution. The result of a Hewlett-Packard choice will be an ideal application and performance fit resulting in greater value.

HP counters offer:

- High measurement accuracy
- Fast system throughput/HP-IB capability
- Low cost of ownership
- Ease of use
- Data reduction on many models
- Triggering simplicity

#### Recent Product Introductions

HP introduces new products every year in an effort to provide the most advanced solutions available. The HP 5361B Pulse/CW Microwave Frequency Counter with built-in profiling provides an ideal and unique measurement solution for radar design engineers. The HP 5347A and HP 5348A portable CW Microwave Frequency Counters with a built-in precision power meter offer a portable and easier-to-use service tool for the telecommunications industry.

The HP 5372A Frequency and Time Interval Analyzer provides extremely powerful

measurement and analysis (often not possible before) to designers of disk and tape drives, agile radios, radars, components such as phase-locked loops and voltage controlled oscillators, and telecommunications products. The extremely powerful HP 5372A is the second product in a new measurement area made possible by the latest innovation in counting technology: "continuous count".

A new full performance universal counter is now available for VXI systems. The HP E1420A is a C-sized card with an outstanding 200 MHz frequency range and 2 ns time interval performance. With exceptional measurement speed and a standardized message-based software interface, the HP E1420A is the ideal systems counters. (See page 624 for more information.)

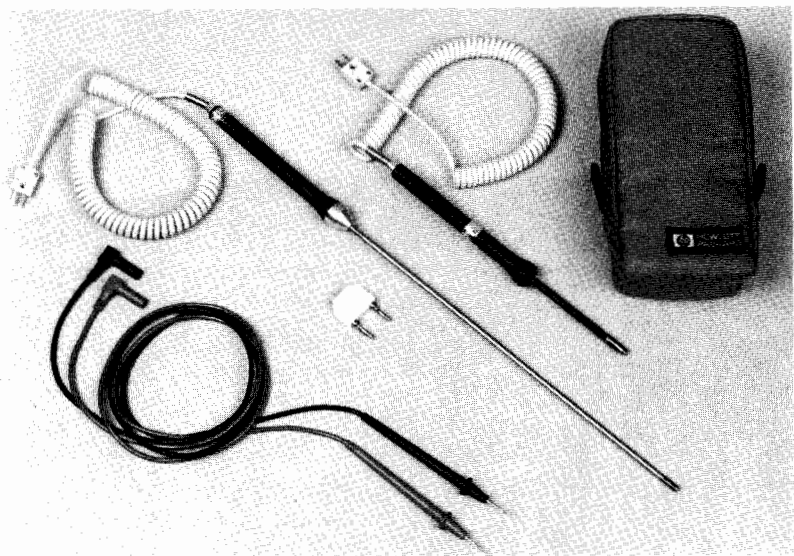

Accessories for handheld multimeters

**Specifications**

23°C ±5°C, <80%RH

Function	Range	Resolution	Accuracy <sup>1</sup> ±(%rdg + number of digits)	
			E2373A	E2377A E2378A
dc voltage	300 mV	100 µV	0.5%+2	0.3%+2
	3V	1 mV	0.7%+1	0.3%+2
	30V	10 mV	0.7%+1	0.4%+1
	300V	100 mV	0.7%+1	0.4%+1
	1000V	1V	0.7%+1	0.4%+1
ac voltage	3V	1 mV	1.2%+4	1.0%+3 <sup>2</sup>
	30V	10 mV	1.2%+4	1.0%+3 <sup>2</sup>
	300V	100 mV	1.2%+4	1.0%+3 <sup>2</sup>
	750V	1V	1.2%+4	1.0%+3 <sup>2</sup>
	dc current	300µA	100 nA	...
3 mA		1 µA	...	1.0%+2
30 mA		10 µA	1.0%+2	1.0%+2
300 mA		100 µA	1.5%+2	1.5%+2
10A		10 mA	1.5%+2	1.5%+2
ac current	300 µA	100 nA	...	2.0%+5
	3 mA	1 µA	...	2.0%+5
	30 mA	10 µA	2.0%+5	2.0%+5
	300 mA	100 µA	2.0%+5	2.0%+5
	10A	10 mA	2.0%+5	2.0%+5
Resistance	300Ω	100mΩ	0.7%+2	0.7%+2
	3 k Ω	1 Ω	0.7%+1	0.7%+1
	30 k Ω	10 Ω	0.7%+1	0.7%+1
	300 k Ω	100 Ω	0.7%+1	0.7%+1
	3 M Ω	1 k Ω	1.5%+1	0.7%+1
	30 M Ω	10 k Ω	3.0%+1	2.0%+1

**Input resistance (dc voltage):** 300mV range >1000MΩ  
 3V range 11MΩ  
 30-1kV ranges 10MΩ

**Maximum input:** 1,000V dc or 750V ac rms

**Continuity check:** 300Ω range; approx. 20Ω threshold

**Temperature test:** -20°C to 700°C with 1° resolution (not E2373A)

**Diode test:** 0.6 mA test current, ±(3%+2 mV) resolution

1) One digit corresponds to the range's resolution

2) 40-500Hz range

	E2373A	E2377A	E2378A
Size			
Height	164mm (6.5")	176mm (6.95")	186mm (7.4")
Width	76mm (3.0")	80mm (3.15")	89mm (3.4")
Depth	33mm (1.3")	45mm (1.4")	45mm (1.4")
Net weight	0.24kg (0.53lb)	0.31kg (0.68lb)	0.45kg (0.99lb)

**Ordering Information**

	<b>Price</b>
<b>HP E2373A Multimeter</b>	(1 ea.) \$99
	(2-5) \$96
	(6-9) \$94
	(10+) \$93
<b>HP E2377A Multimeter</b>	(1 ea.) \$169
	(2-5) \$164
	(6-9) \$161
	(10+) \$159
<b>HP E2378A Multimeter</b>	(1 ea.) \$189
	(2-5) \$183
	(6-9) \$180
	(10+) \$178
<b>HP E2301A Surface Thermocouple Probe</b>	\$120
<b>HP E2302A Airflow Thermocouple Probe</b>	\$75
<b>HP E2303A Thermocouple Probe Adapter</b>	(1 ea.) \$12
	(2+) \$10
<b>HP E2304A Handheld Multimeter Carrying Case</b>	\$19
<b>HP E2305A Replacement Test Leads, 2 pair</b>	\$15

☎ For same-day shipment, call HP DIRECT 800-538-8787

# DIGITAL MULTIMETERS

## 3<sup>1</sup>/<sub>2</sub> Digit Handheld Multimeters

HP E2373A, E2377A, E2378A

- Excellent standard feature set
- Choice of general purpose or rugged model
- 0.3% or 0.7% basic DCV accuracy
- 3-year standard warranty on all models
- 3200 count analog/digital display
- All models in stock



HP E2373A, E2377A, and E2378A

### E2300 Series Handheld Multimeters

The HP E2300 Series of handheld multimeters meet the requirements of your portable basic measurement applications. Standard features on all three models include the following features:

- dc and ac volts, dc and ac current, resistance, audible continuity and diode test
- Maximum 1 kV dc, 750V rms, 10A
- Selection of auto-ranging or manual range hold
- Large 3200 count digital display (samples approx. 2 times/sec.) with 32-segment analog bar (samples approx. 12 times/sec.)
- Display annunciators for all functions (except temperature on E2377A and E2378A), also for low-battery indication, overload, range hold and data hold (E2377A and E2378A)
- Built-in tilt stand and three terminal input jacks
- One-year calibration cycle
- Three-year warranty

### Three Models to Choose From

The basic HP E2373A multimeter is ideal for troubleshooting applications. It offers all the standard features listed above, along with a basic DCV accuracy of 0.7%. Audible continuity and a choice of autoranging or manual ranging make this low-cost meter an excellent and economical choice.

For more exacting tasks on the bench or in the field, the HP E2377A has a basic DCV accuracy of 0.3% and a 1kHz bandwidth. It also adds a data hold function and a temperature function to the solid feature set of the HP E2373A. The temperature function is built-in and can be used with any K-type thermocouple probe.

For outside use and rougher applications, the HP E2378A adds a rugged case to the feature set and accuracy of the HP E2377A. It has all of the same functions and accuracy as the HP E2377A, and is encased in a yellow, splash-proof case.

Refer to the comparison chart in the next column to determine which of the three models best suits your needs.

	E2373A	E2377A	E2378A
Basic dc accuracy	0.7%	0.3%	0.3%
Basic ac accuracy	1.2%	1%	1%
Maximum ac bandwidth	500 Hz	1 kHz	1 kHz
Audible continuity and diode test	Yes	Yes	Yes
Data hold function	No	Yes	Yes
Temperature function	No	Yes	Yes
Input protection up to 300 mA range	0.5A/250V	0.5A/250V	0.5A/250V
10A range	unfused	15A/250V	15A/250V
Power supply (alkaline batteries)	AA(1.5V)x2	AAA(1.5V)x2	AAA(1.5V)x2
Battery life (minimum)	2500h	1000h	1000h

### Standard Accessories are Included

All three meters come with alkaline batteries, spare fuse(s), operating manual and test leads.

### Always in Stock

All three meter models and their accessories are always in stock. Please contact HP for information on quantity price breaks on orders of two or more.

### Additional Accessories

To extend the measurement capability of your handheld multimeter, a variety of accessories are available. These are described below: **HP E2301A** Surface Thermocouple Probe, K-type (-130°C to 260°C; accuracy is greater of  $\pm 2.2^\circ\text{C}$  or 0.75% of reading.) Note: must also order E2303A, Thermocouple Probe Adapter.

**HP E2302A** Airflow Thermocouple Probe, K-type (for range and accuracy, see E2301A.) Note: must also order E2303A, Thermocouple Probe Adapter.

**HP E2303A** Thermocouple Probe Adapter (Uncompensated, banana to K-type connector.) For use with E2377A or E2378A multimeters and any K-type thermocouple probe.

**HP E2304A** Handheld Multimeter Carrying Case (padded, water-resistant nylon case with 2-zipper closing and inside pocket)

**HP E2305A** Replacement test leads (right angle), 2 pair  
For additional multimeter accessories, refer to page 99.

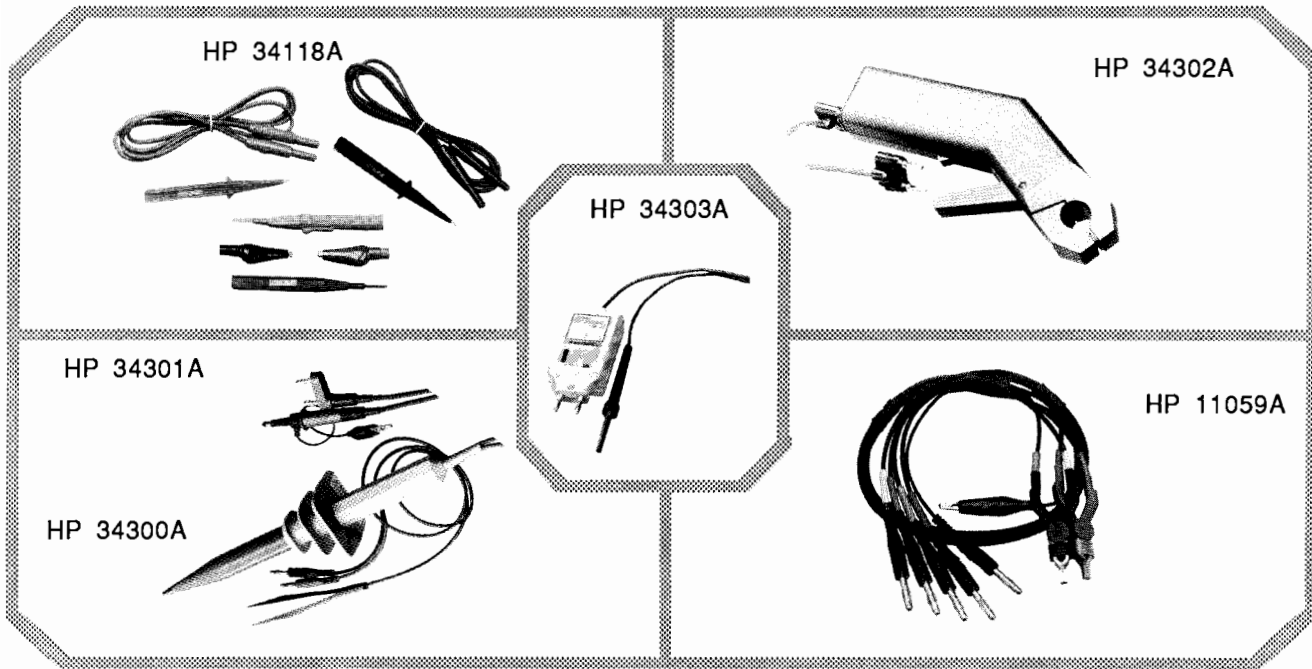

### HP 34301A RF Detector Probe

This probe detects high frequency signals for voltage measurements. The probe can be used with any dmm having a 10 M Ω input.

**Bandwidth:** 100 kHz - 700 MHz

**Voltage range:** 0.25 V - 50 Vrms

**Accuracy:** 100 kHz - 500 MHz, ±1 dB

500 MHz - 700 MHz, ±3 dB

**Input capacitance:** approx. 5 pF

**Maximum ac input:** 50 Vrms

**Transfer ratio:** 1 Vdc output for 1 Vrms input

### HP 34302A Clamp-on AC/DC Current Probe

A clamp-on probe used for measuring ground currents, power supply ripple, or current distribution in systems. This probe allows you to measure ac, dc and ac+dc currents without breaking the circuit.

**Ranges:** ± 10 A dc or 10 A ac

± 100 A dc or 100 A ac

**Frequency response:** dc to 1 kHz

**Recommended load:** >3.0 k Ω

**Rated output:** ± 1.0 V dc at 10 A

± 1.0 V dc at 100 A

**Aperture size:** 19 mm

**Accuracy:** ±2% of rated output

### HP 34300A 40 kV AC/DC High Voltage Probe

A probe for use with any dmm having an input resistance of 10 M Ω. Maximum input (at sea level): 40 kV (dc + peak ac), derated 1% of voltage rating per 100 meters in rise from sea level.

**Voltage division ratio:** 1000:1

**Bandwidth:** dc to 300 Hz

**Input resistance:** 1 G Ω

**Division ratio accuracy:** ±2% (DC, 1000:1, 10 M Ω termination)

### HP 11060A Surface Mount Device Test Probe

Designed for SMD testing, the tweezer design of this probe provides an easy method to access and measure SMD resistive networks. Not to be used over 42 volts peak.

### HP 34303A Temperature Probe

Temperature measurements are read directly in degrees C or F on dmm's having a minimum input impedance of 10 k Ω. The probe is a temperature-to-voltage transducer with a forward-biased diode providing calibrated linear output. A standard dual banana plug output connector provides universal connection to dmm's. A 9 volt battery is required for operation and is not included.

**Temperature range:** -58° to 302 °F;  
-50° to 150 °C

**Output:** 10 mV/° C or °F

**Resolution:** 0.01 °C or °F

**Accuracy:** ±3.0°F;±1.7°C

### HP 11059A Kelvin Probe Set

Works with any dmm with 4-wire ohms. Circuit connection is performed with two gold-plated flat tweezers with special gripping surfaces to ensure precise contact to the components being measured. An alligator clip and lead are provided for either grounding or guarding. Instrument connection is through banana plugs. Not to be used over 42 volts peak.

### Ordering Information

	Price
HP 11002A Test Leads (banana - alligator)	\$22
HP 11003A Test Leads (banana - alligator & probe)	\$22
HP 11053A Low Thermal Lug-Lug Jumper Set	\$29
HP 11058A Low Thermal Banana-Banana Jumper Set	\$29
HP 11059A Kelvin Probe Set	\$135
HP 11060A Surface Mount Device Test Probe	\$24
HP 11062A Kelvin Clip Set	\$26
HP 11096B High Frequency Probe	\$239
HP 11174A Low Thermal Lug-Banana Jumper Set	\$29
HP 34110A Carrying Case for 1/2 Rack Size Instruments	\$82
HP 34111A DC High Voltage Probe	\$265
HP 34118A Test Lead Kit	\$30
HP 34119A High Voltage Probe	\$130
HP 34300A 40 kV AC/DC High Voltage Probe	\$90
HP 34301A RF Detector Probe	\$80
HP 34302A Clamp-on AC/DC Current Probe	\$250
HP 34303A Temperature Probe	\$120

☎ For same day shipment, call HP DIRECT at 800-538-8787.

# DIGITAL MULTIMETERS

## Bench, General Purpose and Wide Bandwidth

### HP 3466A/3400A

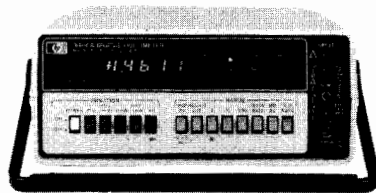

HP 3466A

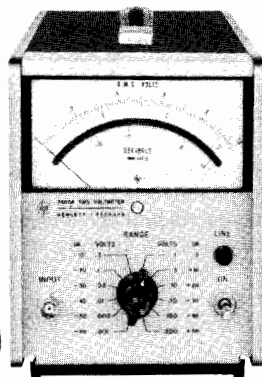

HP 3400A

### HP Model 3466A

The HP 3466A is a 4 1/2 digit autoranging multimeter offering six functions ACV, DCV, ACI, DCI, Ohms, and Diode Test. ACV and ACI measurements are true rms with selectable ac or dc coupling. Available with rechargeable batteries or ac power only, it offers 1  $\mu$ volt and 1 mOhm sensitivity with zero adjustment on the lowest ranges to compensate for external offsets.

### Specifications

#### DC Voltage

Range	Maximum Display	Accuracy: 1 year. 15 to 30 deg. C $\pm$ (% of reading + # of counts)
20 mV	$\pm$ 19.999	0.05 + 3
200 mV	$\pm$ 199.99	0.04 + 2
2 V	$\pm$ 1.9999	0.03 + 1
20 V	$\pm$ 19.999	0.03 + 1
200 V	$\pm$ 199.99	0.035 + 1
1200 V	$\pm$ 1199.9	0.035 + 1, <700 V input
1200 V	$\pm$ 1199.9	0.055 + 1 >700 V input

#### AC Voltage (true-rms responding, true-rms calibrated)

Frequency Range	Accuracy: 1 year. 15 to 30 deg. C $\pm$ (% of reading + # counts)
20 to 30 Hz	2 + 50
30 to 50 Hz	1 + 30
50 Hz to 10 kHz	0.3 + 20
10 to 20 kHz	1 + 40
20 to 100 kHz	2 + 150

**Maximum input:** (ac+dc)V: $\pm$  1200 Vdc, 1700 V (dc + peak ac); acV:  $\pm$ 600 V dc, 1700V(peak ac + dc);  $10^7$  volt-Hz max.

**Crest Factor:** 4:1 at full scale.

#### Resistance

**Ranges:** 20 Ohm to 20 MOhm in 7 ranges

**Input Protection:** 250V or 350V (dc + peak ac).

Range	Accuracy: 1 year. 15 to 30 deg. C $\pm$ (% of reading + # counts)
20 to 200 Ohm	0.08 + 2
2 kOhm to 200 kOhm	0.03 + 1
2000 kOhm	0.04 + 1
20 MOhm	0.15 + 1

#### Current

**Maximum Input:** current: 2 A (fused protected). Voltage: 250 V

#### DC Current

Range	Accuracy: 1 year. 15 to 30 deg. C $\pm$ (% reading + # counts)
200 $\mu$ A, 2mA, 20mA	0.07 + 2
200 mA	0.15 + 2
2000 mA	0.5 + 2

#### AC Current

Range	Frequency	Accuracy: 1 year. 15 to 30 deg.C $\pm$ (% reading + # counts)
200 $\mu$ A to 200 mA	20 to 30 Hz	2.0 + 50
	30 Hz to 10 kHz	0.9 + 35
2000 mA	20 to 30 Hz	2.0 + 50
	30 Hz to 10 kHz	1.2 + 20

#### Ordering Information

**HP 3466A Digital Multimeter.** Standard configuration in a streamlined portable case with handle, ac line power, batteries and charger, and test leads.

**Opt 001** streamlined portable case, ac line power only - \$75

**Opt 002** Rack and Stack case, ac line power only. (Rack mount kit not included.) - \$10

☎ For same-day shipment, call HP DIRECT at 800-538-8787.

#### Price

\$1290 ☎

### HP Model 3400A

The HP 3400A is a true rms analog voltmeter. Six-decade frequency coverage makes the HP 3400A extremely flexible for audio and RF measurements up to 10 MHz and permits the measurement of broadband noise and fast risetime pulses.

Pulses or other non-sinusoids with crest factors up to 10:1 can be measured full scale. Plots of measured data and higher resolution measurements can be produced by connecting a dmm to the convenient rear-panel dc output which produces a linear 0 to 1 volt output proportional to the meter deflection.

### Specifications

**Voltage Range:** 1 mV to 300 V full scale, 12 ranges.

**dB Range:** -72 to + 52 dBm (0 dBm = 1 mW into 600 Ohm).

**Frequency range:** 10 Hz to 10 MHz.

**Response:** responds the rms value (heating value) of the input signal for all waveforms.

**Meter accuracy:** % of full scale (20 to 30 deg. C)\*

10 Hz	50 Hz	1 MHz	2 MHz	3 MHz	10 MHz
5%	1%	2%	3%	5%	

**AC to DC converter accuracy:** % of full scale (20 to 30 deg. C)

10 Hz	50 Hz	1 MHz	2 MHz	3 MHz	10 MHz
5%	0.75%	2%	3%	5%	

\* TC: 0.1% from 0 to 20 and 30 to 55 deg.C

**Crest Factor:** (ratio of peak to rms amplitude of input signal): 10:1 at full scale.

**Input impedance:** from 0.001 to 0.3V range: 10 MOhm shunted by <50 pF. 1.0 to 300 V range: 10 MOhm shunted by < 20 pF, ac coupled input.

**Output:** negative 1 V dc into open circuit at full scale deflection, proportional to meter deflection from 10 to 100% of full scale. 1 mA maximum; nominal source impedance is 1 kOhm. Output noise is <1mV rms.

**Accessories furnished:** 10110A adapter, BNC to dual banana jack.

#### Ordering Information

**HP 3400A RMS Voltmeter**

#### Price

\$2195

**Opt 001** expands the dB scale by placing it on the top of the meter. +\$60

Rear terminals in parallel with front terminals and linear log scale uppermost on the meter face are available on special order.

**Opt 508** extends range to 20 MHz +\$200

**Temperature coefficient:** 0°C to 55°C, 5½ digits, auto zero ON.  
± (% of reading + number of counts)/°C.

Range	Temperature Coefficient
0.3 V, 30 V	0.0008 + 0.5
3 V, 300 V	0.0007 + 0.05

**Noise rejection:** in dB, with 1 kΩ imbalance in Lo lead. AC rejection for 50, 60 Hz ±0.1%. Auto zero ON.

Display	AC NMR	AC ECMR	DC CMR
5½ digits	80	150	140
4½ digits	59	130	140
3½ digits	0	70	140

**Maximum reading rate with HP-41CV:** 2 readings/second.

**Resistance** (2-wire Ω, 4-wire Ω)

**Input Characteristics**

Range	Maximum Reading (5½ digit)	Resolution		
		5½ digit	4½ digit	3½ digit
300 Ω	301.000 Ω	1 mΩ	10 mΩ	100 mΩ
3 kΩ	3.01000 kΩ	10 mΩ	100 mΩ	1 Ω
30 kΩ	30.1000 kΩ	100 mΩ	1 Ω	10 Ω
300 kΩ	301.000 kΩ	1 Ω	10 Ω	100 Ω
3 MΩ	3.01000 MΩ	10 Ω	100 Ω	1 kΩ
30 MΩ	30.1000 MΩ	100 Ω	1 kΩ	10 kΩ

**Input protection** (non-destructive): ± 350 V peak.

**Measurement accuracy:** ±(% of reading + number of counts). Auto zero ON. 5½ digit display. 4-wire ohms.

Range	TCal* ±1°C 24 Hour	TCal* ±5°C	
		90 Day	1 Year
300 Ω	0.0045 + 4	0.012 + 4	0.017 + 5
3 kΩ-300 kΩ	0.0035 + 2	0.011 + 2	0.016 + 2
3 MΩ	0.0052 + 2	0.011 + 2	0.016 + 2
30 MΩ	0.036 + 2	0.066 + 2	0.078 + 2

**Current Through Unknown**

Range	300 Ω	3 kΩ	30 kΩ	300 kΩ	3 MΩ	30 MΩ
Current	1 mA	1 mA	100 μA	10 μA	1 μA	100 nA

**Maximum open circuit voltage:** 6.5 V

**AC Voltage** (true RMS responding)

**Input Characteristics**

Range	Maximum Reading (5½ digit)	Resolution		
		5½ digit	4½ digit	3½ digit
0.3 V	0.301000 V	1 μV	10 μV	100 μV
3 V	3.01000 V	10 μV	100 μV	1 mV
30 V	30.1000 V	100 μV	1 mV	10 mV
300 V	301.000 V	1 mV	10 mV	100 mV

**Input impedance:** 1 MΩ ±1% shunted by <60 pF.

**Maximum input voltage** (non-destructive): 301 Vrms or 450 V peak.

**Measurement accuracy:** ±(% of reading + number of counts) Auto zero ON. 5½ digit display. Accuracy is specified for sinewave inputs only, >10% of full scale.

**1 Year, TCal ±5°C**

Frequency	Ranges		
	0.3V	3 V, 30 V	300 V
20-50 Hz	1.14 + 163	1.14 + 102	1.18 + 102
50-100 Hz	0.46 + 163	0.46 + 103	0.5 + 102
100 Hz-20 kHz	0.29 + 163	0.26 + 102	0.33 + 102
20-50 kHz	0.56 + 247	0.41 + 180	0.55 + 180
50-100 kHz	1.74 + 882	1.05 + 825	1.26 + 825
100 k-300 kHz	10.1 + 3720 (30 V range only)		

**Crest factor:** >4:1 at full scale.

**DC Current Input Characteristics**

Range	Maximum Reading (5½ digit)	Resolution		
		5½ digit	4½ digit	3½ digit
3 A	± 3.01000 A	10 μA	100 μA	1 mA

**Maximum input** (non-destructive): 3 A from <250 V source; fuse protected.

**Measurement accuracy:** ±(% of reading + number of counts). Auto zero ON. 5½ digit display.

Range	TCal ±5°C	
	90 Days	1 Year
3 A, <1 A input	0.14 + 6	0.17 + 6
3 A, >1 A input	1.0 + 30	1.0 + 30

**AC Current** (true RMS responding)

**Input Characteristics**

Range	Maximum Reading (5½ digit)	Resolution		
		5½ digit	4½ digit	3½ digit
0.3 A	0.301000 A	1 μA	10 μA	100 μA
3 A	3.01000 A	10 μA	100 μA	1 mA

**Maximum input** (non-destructive): 3 A from <250 V source; fuse protected.

**Measurement accuracy:** ±(% of reading + number of counts). Auto zero ON. 5½ digit display. Accuracy specified for sinewave inputs only, >10% of full scale.

**1 Year, TCal ±5°C**

Frequency	Ranges	
	0.3 A	3 A
20-50 Hz	1.77 + 163	2.5 + 163
50-1 kHz	1.1 + 163	1.8 + 163
1 k-10 kHz	1.0 + 163	1.7 + 163
10 k-20 kHz	1.14 + 163	1.84 + 163

**General Information**

**Operating temperature:** 0 to 55°C

**Humidity range:** 95% RH, 0 to 40°C

**Power:** ac line 48 to 440 Hz, 86 to 250 V, (see configuration)

**Battery:** (Opt 001) Rechargeable lead-acid; minimum continuous operation for 5 hours at 25°C; recharge time is 16 hours with HP 3468A/B off and 36 hours with HP 3468A/B on.

**Size:** HP 3468A: 98.4 H x 238.1 W x 276.2 mm D (3.88" x 9.38" x 10.88"). 3468B: 89 H x 213 W x 275 mm D (without feet), 3.5" x 8.38" x 10.83".

**Weight:** HP 3468A/B—2.1 kg (4.63 lb); HP 3468A/B with Opt 001—3.1 kg (6.83 lb).

**Configuration** order one power and frequency option at no charge from below.

**Opt 315** 100 V, 50 Hz; **Opt 335** 220 V, 50 Hz

**Opt 316** 100 V, 60 Hz; **Opt 336** 220 V, 60 Hz

**Opt 325** 120 V, 50 Hz; **Opt 345** 240 V, 50 Hz

**Opt 326** 120 V, 60 Hz; **Opt 346** 240 V, 60 Hz

**Ordering Information**

**HP 3468A DMM** in Streamlined Portable Case with HP-IL and test probes.

**HP 3468B DMM** in Rack and Stack Case with HP-IL and test probes.

**Options and Accessories**

**HP 3468A/B Option W30**, add 3 year Extended Hardware Support \$25

**HP 3468A/B Option 001**, add Rechargeable Battery Pack \$182

**HP 3468B Option 401**, add Side Handle Kit (HP P/N 5061-1171) \$45

**HP 3468B Option 907**, add Front Handle Kit (HP P/N 5061-1170) \$65

**HP 3468B Option 908**, add Rackmount Kit for a Single Instrument (HP P/N 5060-0173) \$60

**HP P/N 5060-0174 Rackmount Kit** for rack mounting two instruments side-by-side \$87.50

☎ For same day shipment, call HP DIRECT 800-538-8787.

**Price**

\$820 ☎

\$820 ☎

# DIGITAL MULTIMETERS

## High Performance 5½ to 3½ Digit Bench DMM

HP 3468A/B

- Five functions
- Electronic calibration
- 5½ to 3½ digits

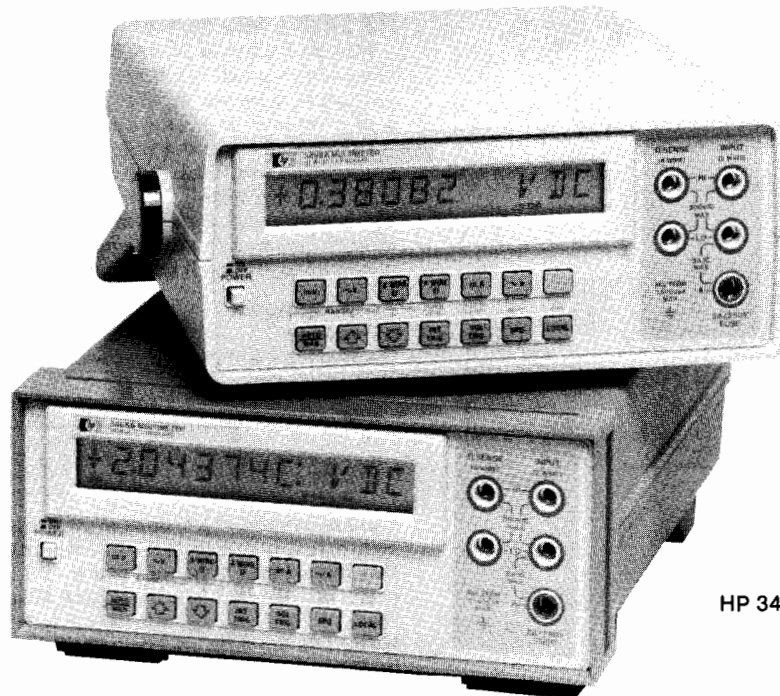

HP 3468A

HP 3468B

### Description

The HP Models 3468A/B are autoranging 5½ to 3½ digit DMMs, with the five functions of dc volts, true RMS ac volts, 2- and 4-wire ohms, dc current and true RMS ac current. They are low-cost, highly reliable DMMs which can be completely calibrated electronically, either manually from the front panel or remotely in an automatic calibration system. Remote calibration is made possible by the built-in HP-IL (Hewlett-Packard Interface Loop) interface which provides complete programmability of functions, ranges and modifiers.

The HP 3468A comes in a streamlined portable package with a handle for convenient carrying, whereas the HP 3468B comes in a plastic system case for easy rack mounting. Both are available with a rechargeable battery and battery charging circuitry for portable measurements.

### High Performance

The HP 3468A/B have 5 functions with selectable 5½, 4½ or 3½ digit resolution. DC and true RMS ac voltage measurements are provided from 0.3 volt full scale range with 1 µV sensitivity up to 300 volts. The bandwidth of the true RMS ac converter is from 20 Hz to 100 kHz on all ranges and up to 300 kHz on the 30 V range. Either 2 or 4-wire ohms measurements can be selected with a maximum range of 30 MΩ. Both dc and true RMS ac current capability is provided up to 3 A. All functions on the HP 3468A/B incorporate fast autoranging. The HP 3468A/B use an integrating analog to digital conversion technique for high noise rejection. The selectable 3½, 4½ or 5½ digits of resolution allows flexibility for choosing speed or noise rejection.

### Electronic Calibration

Complete calibration of the HP 3468A/B is done electronically, either manually from the front panel or remotely in an automatic calibration system. There are no internal adjustments necessary. Complete calibration of all functions is done without removal of the instrument's covers, thus saving valuable time and reducing cost. The calibration procedure for the HP 3468A/B involves connecting a calibration standard to the input, then pressing three keystrokes to store one calibration constant in CMOS RAM for each range and function.

When the HP 3468A/B make a measurement, each reading is corrected according to the calibration constants that have been stored. The internal CMOS RAM used in the HP 3468A/B is powered by a lithium battery to create a non-volatile memory capable of holding the calibration constants for more than ten years.

### Battery

The optional battery pack includes a rechargeable battery and the battery charger circuitry for up to five hours of continuous measurements.

### Specifications

#### DC Voltage Input Characteristics

Range	Maximum Reading (5½ digit)	Resolution		
		5½ digit	4½ digit	3½ digit
0.3 V	±0.301000 V	1 µV	10 µV	100 µV
3 V	± 3.01000 V	10 µV	100 µV	1 mV
30 V	± 30.1000 V	100 µV	1 mV	10 mV
300 V	± 301.000 V	1 mV	10 mV	100 mV

**Input resistance:** 0.3 V, 3 V ranges: >10<sup>10</sup> Ω  
30 V, 300 V ranges: 10 MΩ ±1%

**Maximum input voltage** (non-destructive)

Hi to Lo: 301 Vrms or 450 V peak

Hi or Lo to Earth Ground: ±500 V peak

**Measurement accuracy:** ±(% of reading + number of counts).  
Auto zero ON. 5½ digits.

Range	TCal*±1°C 24 Hour	TCal*±5°C	
		90 Day	1 Year
0.3 V	0.005 + 4	0.009 + 5	0.02 + 5
3 V	0.0035 + 2	0.0072 + 2	0.0181 + 2
30 V	0.005 + 3	0.009 + 3	0.02 + 3
300 V	0.0055 + 2	0.009 + 2	0.02 + 2

\*TCal is the temperature of the environment where the 3468A/B was calibrated. Calibration should be performed with the temperature of the environment between 20°C and 30°C.

- 5½/6½-digit DVM with auto cal
- High speed 3½ digit system voltmeter

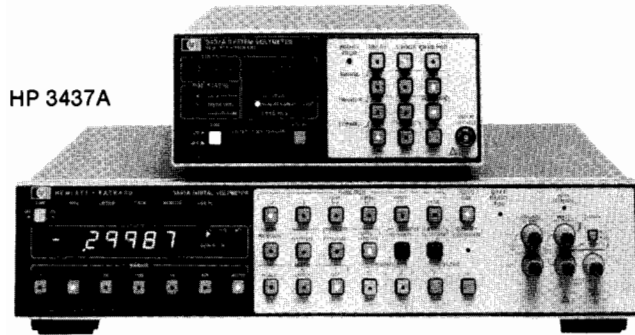

HP 3437A

HP 3455A

### HP 3437A Multimeter

The Hewlett-Packard 3437A System Voltmeter is designed for systems. It is a 3½-digit, high-speed dc voltmeter with sample and hold. The standard unit measures dc volts, provides trigger delay, burst reading capability and Hewlett-Packard Interface Bus (HP-IB).

There are three dc floating input ranges: 0.1 V, 1.0 V and 10.0 V full scale with a maximum display of "1998." Sample and Hold allow the HP 3437A to be an instantaneous reading voltmeter. The trigger delay can be set from 0.1 μs to 1.0 second and the number of readings can be set from 0 to 9999 readings.

#### Specifications

**Static Accuracy (90 days, 23°C ± 5°C)**

**10 V range:** ±(0.05% of reading + 1.6 counts).

**Static accuracy temperature coefficient (0°C–50°C):** ±(0.002% reading + 0.05 counts) / °C.

#### Input Characteristics

**10 V range:** R = 1 MΩ ± 20%; C < 75 pF.

**Maximum input voltage high to low on all ranges:** < ±30 V peak.

**Maximum voltage low to chassis:** ±42 V peak.

**Maximum reading rate (remote, N Rdgs. > 1, and a zero delay listener)**

**ASCII:** 3600 readings/s.

**Packed:** 5700 readings/s.

**Input Bandwidth (3 dB) 1 V and 10 V range:** 1.0 MHz.

#### General

**Operating temperature:** 0 to 55°C.

**Storage temperature:** -40°C to 75°C.

**Humidity range:** < 95% R.H., 0°C to 40°C.

**Power:** 100 V, 120 V, 220 V, 240 V +5%, -10%, 48 Hz to 440 Hz line operation, < 42 VA.

**Size:** 88.9 H x 212.7 W x 527.1 mm D (3½" x 8⅜" x 20¾").

**Weight:** net, 5.6 kg (12 lb 4 oz). Shipping, 7.6 kg (16 lb 12 oz).

#### Ordering Information

HP 3437A System Voltmeter

Opt W30 extended repair service. See page 723.

#### Price

\$4395

+ \$95

### HP 3455A Multimeter

Hewlett-Packard's 3455A Digital Voltmeter is a 5½ to 6½-digit integrating voltmeter for bench or systems applications. The standard instrument measures dc volts, ac volts, and resistance. HP-IB and auto or manual ranging are also standard.

DC measurements can be made with up to 1 μV sensitivity. Ohms measurements are made with either a 2-wire and 4-wire mode. The high resolution (6½-digit) mode gives dc and ohms measurements with greater than 1 part per million resolution. The standard true rms ac to dc converter measures sinusoid and complex signals with crest factors up to 7:1 at full scale from 30 Hz to 1 MHz.

#### Specifications

##### DC Voltage

**Accuracy** ± (% of reading + counts), 6½ digit mode

24 hrs: 23°C ± 1°C		
Range	24 Hrs.	90 Days
1 V	0.003 + 4	0.006 + 4
10 V	0.002 + 3	0.005 + 3
100 & 1000 V	0.004 + 3	0.007 + 3

**Input resistance:** 0.1 V through 10 V range: > 10<sup>10</sup> ohms. 100 V and 1000 V range: 10 megohm ± 0.1% with Auto Cal. "off."

**Maximum input voltage:** High to low input terminals: ±1000 V peak; Guard to chassis: ±500 V peak; Guard to low terminal: ±200 V peak.

**NMR at 50 or 60 Hz ± 0.1%:** > 60 dB.

**ECMR with 1 kΩ unbalance in low lead at dc:** > 160 dB

##### ac voltage (rms converter)

##### Input impedance

**Front terminals:** 2 MΩ ± 1% shunted by less than 100 pf.

**Rear terminals:** 2 MΩ ± 1% shunted by less than 75 pf.

##### Maximum input voltage

High to low terminals: ±1000 volts peak; 10<sup>7</sup> VHz max.

Guard to chassis: ±500 V peak; Guard to low terminal: ±200 V peak.

**Crest factor:** 7:1 at full scale.

**Accuracy:** [± % of reading + counts] (ac coupled)

Fast acV	300 Hz to 20 kHz	20 kHz to 100 kHz	100 kHz to 250 kHz	250 kHz to 500 kHz	500 kHz to 1 MHz
	30 Hz to 20 kHz				
90 days 23°C ± 5°C	0.05 + 50	0.50 + 100	2.00 + 250	5.00 + 500	6.00 + 3100

##### Resistance

**Accuracy** ± (% of reading + counts) 4-wire, 6½ digit mode

24 hours: 23°C ± 1°C		
Range	24 Hours	90 Days
1 kΩ	0.0025 + 4	0.0035 + 5
10 kΩ	0.0045 + 4	0.0060 + 5
100 kΩ	0.0020 + 5	0.0035 + 6
1000 kΩ	0.0120 + 4	0.0135 + 5
10,000 kΩ	0.1000 + 4	0.1000 + 5

##### Maximum Readings per Second for Remote Operations.

Function	50 Hz	60 Hz
dcV	22	24
Ohms	11	12
acV (rms)	1.1	1.3
Fast acV (rms)	12	13

#### General

**Power:** 100 V, 120 V, 240 V +5% -10%, 48-400 Hz; < 60 VA.

**Size:** 88.9 H x 425.5 W x 527.1 mm D (3.5" x 16.75" x 20.75").

**Weight:** net, 9.38 kg (20.7 lb); shipping, 11.8 kg (26 lb).

#### Ordering Information

HP 3455A Digital Voltmeter

Opt 001 average converter

#### Price

\$7295

- \$97



# DIGITAL MULTIMETERS

## 6½ to 3½ Digit HP-IB DMM with High Stability

### HP 3456A

- Up to 330 readings per second
- 100 nanovolt resolution

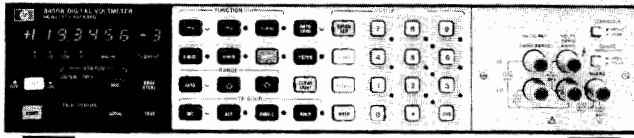

### Description

This fully guarded, integrating Digital Multimeter is designed for bench or systems. The HP Model 3456A measures dc, true RMS ac voltage and resistance.

Measurement speed and accuracy can be enhanced for a specific application, using the HP 3456A's selectable integration time (up to 100 power line cycles). An operator can select up to 330 readings/second for high speed bursts or one reading every fifteen minutes for periodic measurements. Resolution of 100 nanovolts at 48 readings/second (6½ digits) to 10 microvolt resolution at 330 readings per second (3½ or 4½ digits) can be selected.

With good repeatability and 100 nanovolt sensitivity, accuracy on the ten volt range is  $\pm 0.0008\% + 2$  counts over a 24-hour period at  $23^\circ\text{C} \pm 1^\circ\text{C}$ .

Four full-scale, true rms ac voltage ranges are provided, with reading speeds up to 12 readings per second over a 10 Hz to 250 kHz frequency range. Best accuracy is 0.05%. Crest factor is greater than seven at full scale.

With the HP 3456A's program memory and reading storage capability, the HP 3456A can take measurements and store them while a computer performs some other task.

Another system feature of the HP 3456A is its hardware scanner advance capability for scanned or multiplexed system applications. As soon as the HP 3456A's measurement cycle is complete, a TTL signal is available to trigger a variety of switching instruments.

### Specifications

#### DC Voltage

Range	Maximum Reading (5½ digit)	6½ digit	Resolution 5½ digit	4½ digit	Input Resistance	Maximum Input Voltage
0.1 V	.119999 V	100 nV	1 $\mu\text{V}$	10 $\mu\text{V}$	$>10^{10} \Omega$	$\pm 1000$ V peak
1.0 V	1.19999 V	1 $\mu\text{V}$	10 $\mu\text{V}$	100 $\mu\text{V}$	$>10^{10} \Omega$	
10.0 V	11.9999 V	10 $\mu\text{V}$	100 $\mu\text{V}$	1 mV	$>10^{10} \Omega$	
100.0 V	119.999 V	100 $\mu\text{V}$	1 mV	10 mV	10 M $\Omega \pm 5\%$	
1000.0 V	1000.00 V	1 mV	10 mV	100 mV	10 M $\Omega \pm 5\%$	

Measurement accuracy:  $\pm$  (% of reading + number of counts).

RANGE	24 hour: $23^\circ\text{C} \pm 1^\circ\text{C}$		90 days: $23^\circ\text{C} \pm 5^\circ\text{C}$		1 year: $23^\circ\text{C} \pm 5^\circ\text{C}$	
	6½ digit ( $\geq 10$ PLC)	6½ digit (1 PLC)	6½ digit ( $\geq 10$ PLC)	6½ digit (1 PLC)	6½ digit ( $\geq 10$ PLC)	6½ digit (1 PLC)
0.1 V	.0022 + 24	0.0024 + 32	0.0026 + 24	0.0027 + 32	0.0034 + 24	0.0035 + 32
1.0 V	0.0009 + 4	0.0012 + 5	0.0016 + 4	0.0017 + 5	0.0024 + 4	0.0025 + 5
10.0 V	0.0008 + 2	0.0011 + 3	0.0015 + 2	0.0016 + 3	0.0023 + 2	0.0024 + 3
100.0 V	0.0011 + 3	0.0014 + 4	0.0018 + 3	0.0019 + 4	0.0026 + 3	0.0027 + 4
1000.0 V	0.0011 + 2	0.0013 + 3	0.0016 + 2	0.0017 + 3	0.0024 + 2	0.0025 + 3

$\pm \text{Add } .02 \left( \frac{\text{Input Voltage}}{1000} \right)^2$  % to % of reading.

#### AC RMS Voltage (AC, AC + DC)

Range	Maximum Reading (5½ digit)	6½ digit	Resolution 5½ digit	4½ digit	Input Impedance	Maximum Input Voltage
1.0 V	1.19999 V	1 $\mu\text{V}$	10 $\mu\text{V}$	100 $\mu\text{V}$	1 M $\Omega \pm 5\%$	$\pm 1000$ V peak
10.0 V	11.9999 V	10 $\mu\text{V}$	100 $\mu\text{V}$	1 mV	shunted by $<90$ pF	(700 V rms)
100.0 V	119.999 V	100 $\mu\text{V}$	1 mV	10 mV		10 <sup>8</sup> VHZ
1000.0 V	700.00 V	1 mV	10 mV	100 mV		

- 100 micro-ohm to 1.0 gigaohm

Measurement accuracy:  $\pm$  (% of reading + number of counts).  
90 days:  $23^\circ\text{C} \pm 5^\circ\text{C}$

Integration Time In Power Line Cycles	Frequency In Hz					
	10 to 20	Filter Off → 20 to 30	400-20k 30-20k	20k to 50k 20k to 50k	50k to 100k 50k to 100k	100k to 250k 100k to 250k
$>1^*$ (6 Digit) <sup>2</sup>	.47 + 450	.35 + 500	.07 + 730	.17 + 1700	.55 ± 2900	5.0 + 6500
.1~ (5 Digit)	.48 + 90	.36 + 53	.08 + 73	.18 + 173	.56 + 293	5.0 + 653
.01~ (4 Digit)	.56 + 10	.41 + 7	.13 + 9	.23 + 19	.61 + 31	5.1 + 67

\*Frequencies  $> 100$  kHz are specified for 1.0 V and 10 V ranges only.

<sup>2</sup>Integration time in power line cycles (PLC). For 5½ digits, multiply counts by 0.1. For 4½ digits, multiply counts by 0.01.

#### Resistance (2 W $\Omega$ , 4 W $\Omega$ , 2 WOC $\Omega$ , 4 WOC $\Omega$ )

Range	Maximum Reading (5½ digit)	6½ digit	Resolution 5½ digit	4½ digit	Current Through Unknown
100 $\Omega$	119.999 $\Omega$	100 $\mu\Omega$	1 m $\Omega$	10 m $\Omega$	1 mA
1 k $\Omega$	1199.99 $\Omega$	1 m $\Omega$	10 m $\Omega$	100 m $\Omega$	1 mA
10 k $\Omega$	11.9999 k $\Omega$	10 m $\Omega$	100 m $\Omega$	1 $\Omega$	100 $\mu\text{A}$
100 k $\Omega$	119.999 k $\Omega$	100 m $\Omega$	1 $\Omega$	10 $\Omega$	50 $\mu\text{A}$
1 M $\Omega$	1199.99 k $\Omega$	1 $\Omega$	10 $\Omega$	100 $\Omega$	5 $\mu\text{A}$
10 M $\Omega$	11.9999 M $\Omega$	10 $\Omega$	100 $\Omega$	1 k $\Omega$	500 nA
100 M $\Omega$	119.999 M $\Omega$	100 $\Omega$	1 k $\Omega$	10 k $\Omega$	$<500$ nA <sup>1</sup>
1 G $\Omega$	1000.00 M $\Omega$	1 k $\Omega$	10 k $\Omega$	100 k $\Omega$	$<500$ nA <sup>1</sup>

<sup>1</sup>Ohms measure is a 500 nA current source in parallel with a 10 M $\Omega$  resistance.

Measurement accuracy:  $\pm$  (% of reading + number of counts).

RANGE	24 hour: $23^\circ\text{C} \pm 1^\circ\text{C}$		90 days: $23^\circ\text{C} \pm 5^\circ\text{C}$	
	6½ digit ( $\geq 10$ PLC)	6½ digit (1 PLC)	6½ digit ( $\geq 10$ PLC)	6½ digit (1 PLC)
100 $\Omega$	0.003 + 24	0.003 + 32	0.004 + 24	0.004 + 32
1 k $\Omega$	0.002 + 4	0.003 + 5	0.003 + 4	0.004 + 5
10 k $\Omega$	0.002 + 4	0.003 + 5	0.003 + 4	0.004 + 5
100 k $\Omega$	0.002 + 2	0.003 + 3	0.003 + 2	0.004 + 3
1 M $\Omega$	0.006 + 2	0.006 + 3	0.007 + 2	0.007 + 3
10 M $\Omega$	0.041 + 2	0.041 + 3	0.042 + 2	0.042 + 3
100 M $\Omega$	1.3 + 1	1.3 + 1	1.8 + 1	1.8 + 1
1 G $\Omega$	11 + 1	11 + 1	16 + 1	16 + 1

#### Ratio

Type: dc/dc, ac/dc, or (ac + dc)/dc

Method: 4-wire with Volts Lo input common

$$\text{Ratio} = \frac{\text{Signal Voltage}}{\text{Ref. Hi Voltage} - \text{Ref. Lo Voltage}}$$

#### Reading Rate

Integration Time In Power Line Cycles (PLC)	Rates (rdgs/second)			
	Auto Zero Off		Auto Zero On	
	60 Hz	50 Hz	60 Hz	50 Hz
0.01 (4½ digit)	330	290	210	180
0.10 (5½ digit)	210	180	120	100
1.00 (6½ digit)	48	40	25	20
10.00 (6½ digit)	5.8	4.8	2.9	2.4
100.00 (6½ digit)	.57	.47	.29	.24

#### Memory

Reading store: Store up to 350 readings.

Program memory: can execute an internal program which controls instrument configuration and measurement sequence.

#### General

Operating temperature: 0 to  $50^\circ\text{C}$

Humidity Range: 95% R.H., 0 to  $40^\circ\text{C}$

Power: 100/120/220/240 V +5%, -10%, 48 Hz to 400 Hz line operation, 45 VA max.

Size: 88.9 H x 425.5 W x 527.1 D (3½" x 16¾" x 20¾")

Weight: net, 10.49 kg (23.13 lb.); shipping, 13.35 kg (29.38 lb.)

#### Ordering Information

HP 3456A digital voltmeter

Opt 050: Noise rejection for 50 Hz

Opt 060: Noise rejection for 60 Hz

Opt W30: 3 year hardware support. See page 723.

Price

\$5695

\$0

\$0

+\$120

**Temperature coefficient:** 0° to 55°C, 5½ digits, auto zero ON. ±(% of reading + number of counts)/°C

Range	Temperature Coefficient
30 mV	0.0028 + 5.0
300 mV	0.0005 + 0.5
3 V	0.0004 + 0.05
30 V	0.0006 + 0.5
300 V	0.0004 + 0.05

**Noise rejection:** in dB with 1 kΩ imbalance in Lo lead; ac rejection for 50, 60 Hz ± 0.1%. Auto zero ON.

Display	ac NMR	ac ECMR	dc CMR
5½ digits	80	150	140
4½ digits	59	130	140
3½ digits	0	70	140

**Maximum Reading Rates** (readings/s.)

Line Frequency	Auto Zero and Display	Resolution		
		3½ digits	4½ digits	5½ digits
60 Hz	Off	90	35	4.4
	On	60	20	2.3
	Off	85	30	3.7
50 Hz	On	50	17	1.9

**AC Voltage** (true rms) **Input Characteristics**

Range	Maximum Reading (5½ Digit)	Resolution		
		5½ Digit	4½ Digit	3½ Digit
300 mV	303.099 mV	1 µV	10 µV	100 µV
3 V	3.03099 V	10 µV	100 µV	1 mV
30 V	30.3099 V	100 µV	1 mV	10 mV
300 V	303.009 V	1 mV	10 mV	100 mV

**Input impedance:** 1 MΩ ± 1% shunted by <60 pF  
**Maximum Input Voltage** (non-destructive):  
 Hi to Lo: 303 Vrms or 450 V peak  
 Hi or Lo to Earth Ground: ±500 V peak  
**Measurement accuracy:** ±(% of reading + number of counts). Auto zero ON. 5½ digit display. Accuracy is specified for sinewave inputs only, >10% full scale.

**1 Year, T<sub>Cal</sub>\* ± 5°C**

Frequency	Ranges		
	300 mV	3 V, 30 V	300 V
20-50 Hz	1.14 + 163	1.14 + 102	1.18 + 102
50-100 Hz	0.46 + 163	0.46 + 103	0.50 + 102
100 Hz-20 kHz	0.20 + 120	0.20 + 70	0.24 + 70
20-50 kHz	0.38 + 205	0.26 + 140	0.42 + 140
50-100 kHz	1.20 + 840	0.87 + 780	0.98 + 780
100-300 kHz	10.1 + 3720 (30 V range only)		

**Crest factor:** >4:1 at full scale  
**Common mode rejection:** with 1 kΩ imbalance in Lo lead, >70 dB, at 60 Hz  
**Maximum reading rates:** 3½ or 4½ digits, 1.4 readings/s; 5½ digits, 1.0 readings/s. First reading is correct within 70 counts of final value when triggered coincident with step input. Add 0.6 seconds for each range change.

**Resistance** (2-wire Ω, 4-wire Ω) **Input Characteristics**

Range	Maximum Reading (5½ Digit)	Resolution		
		5½ Digit	4½ Digit	3½ Digit
30 Ω	30.3099 Ω	100 µΩ	1 mΩ	10 mΩ
300 Ω	303.099 Ω	1 mΩ	10 mΩ	100 mΩ
3 kΩ	3.03099 kΩ	10 mΩ	100 mΩ	1 Ω
30 kΩ	30.3099 kΩ	100 mΩ	1 Ω	10 Ω
300 kΩ	303.099 kΩ	1 Ω	10 Ω	100 Ω
3 MΩ	3.03099 MΩ	10 Ω	100 Ω	1 kΩ
30 MΩ	30.3099 MΩ	100 Ω	1 kΩ	10 kΩ

**Input protection** (non destructive): Hi to Lo: ±350 V peak; Hi or Lo to Earth Ground: ±500 V peak.

**Measurement accuracy:** ±(% of reading + number of counts). Auto zero ON. 5½ digit display. 4-wire ohms.

Range	T <sub>Cal</sub> * ± 5°C		
	24 Hour	90 Day	1 Year
30 Ω	0.023 + 35	0.027 + 41	0.034 + 41
300 Ω	0.0045 + 4	0.012 + 5	0.017 + 5
3 k-300 kΩ	0.0035 + 2	0.011 + 2	0.016 + 2
3 MΩ	0.0052 + 2	0.011 + 2	0.016 + 2
30 MΩ	0.036 + 2	0.066 + 2	0.078 + 2

**Current Through Unknown**

Range	30 Ω	300 Ω	3 kΩ	30 kΩ	300 kΩ	3 MΩ	30 MΩ
Current	1 mA	1 mA	1 mA	100 µA	10 µA	1 µA	100 nA

**DC Current Input Characteristics**

Range	Maximum Reading (5½ Digit)	Resolution		
		5½ Digit	4½ Digit	3½ Digit
300 mA	± 303.099 mA	1 µA	10 µA	100 µA
3 A	± 3.03099 A	10 µA	100 µA	1 mA

**Maximum input** (non-destructive): 3 A from <250 V source; fuse protected.

**Measurement accuracy:** ±(% of reading + number of counts). Auto zero ON. 5½ digit display.

Range	T <sub>Cal</sub> * ± 5°C	
	90 Days	1 Year
300 mA	0.11 + 40	0.15 + 40
3 A (<1 A)	0.14 + 6	0.17 + 6
3 A (>1 A)	1.0 + 30	1.0 + 30

**Maximum burden at full scale:** 1 V (3 A range), 0.1 V (0.3 A range)

**AC Current** (true rms responding) **Input Characteristics**

Range	Maximum Reading (5½ Digit)	Resolution		
		5½ Digit	4½ Digit	3½ Digit
300 mA	303.099 mA	1 µA	10 µA	100 µA
3 A	3.03099 A	10 µA	100 µA	1 mA

**Maximum input:** (non-destructive): 3 A from <250 V source; fuse protected.

**Measurement accuracy:** ±(% of reading + number of counts). Auto zero ON. 5½ digit display. Accuracy is specified for sinewave inputs only, >10% of full scale.

**1 Year, T<sub>Cal</sub>\* ± 5°C**

Frequency	Ranges	
	300 mA	3 A
20-50 Hz	1.54 + 163	2.24 + 163
50-1 kHz	0.81 + 163	1.50 + 163
1 k-10 kHz	0.72 + 163	1.42 + 163
10 k-20 kHz	0.86 + 163	1.56 + 163

**Maximum burden at full scale:** 1 V RMS (3A range)

**General**

**Operating temperature** 0 to 55°C  
**Humidity range** 95% R.H., 0 to 40°C  
**Power** ac line 48 to 440 Hz; 86 to 250 V, 25 VA max.  
**Size** 102 mm H x 215 mm W x 356 mm D (4" x 8" x 14"); 3½ in. H without feet.  
**Weight** 3 kg (6.5 lb)  
**HP-IB Interface Functions** SH1, AH1, T5, TE0, L4, LE0, SR1, RL1, PP0, DC1, DT1, C0

**Ordering Information**

HP 3478A Multimeter	<b>Price</b> \$995
Choose one power option (no charge):	
Opt 315 100 V, 50 Hz; Opt 335 220 V, 50 Hz	\$0
Opt 316 100 V, 60 Hz; Opt 336 220 V, 60 Hz	\$0
Opt 325 120 V, 50 Hz; Opt 345 240 V, 50 Hz	\$0
Opt 326 120 V, 60 Hz; Opt 346 240 V, 60 Hz	\$0
Opt W30 extended repair service. See page 723.	+\$35
Opt 907 Front Handle Kit (5061-0088)	+\$51
Opt 908 Rack Mount Kit (5061-0072)	+\$54
Opt 910 Extra Manuals (03478-90008 and 03478-90009)	+\$22

For same-day shipment, call HP DIRECT at 800-538-8787

# DIGITAL MULTIMETERS

## Low Cost 3½ to 5½ Digit HP-IB Multimeter HP 3478A

- 5 measurement functions
- Up to 90 readings/s

- Electronic calibration
- 100 nanovolt resolution

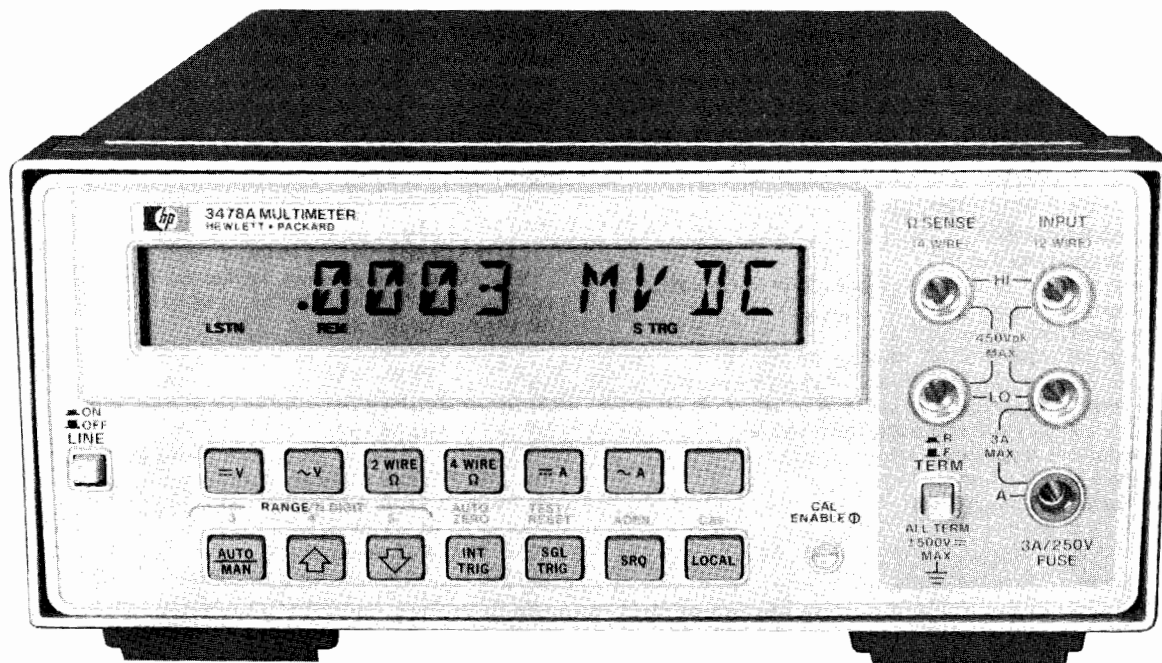

HP 3478A

### Description

The HP 3478A is a low cost, full function, reliable DMM for system measurements. Selectable 3½ to 5½ digit resolution and 5 autoranging functions offer flexibility in automated testing. The HP 3478A measures dcV, true rms acV, 2- and 4-wire resistance, and dc and ac current. Simple, fast electronic calibration eliminates all adjustments to provide a lower cost of ownership.

### Low Cost of Ownership

The combination of an extremely reliable DMM with complete electronic calibration and self-test gives you low cost of ownership. The proven reliability of the HP 3478A is so good that Hewlett-Packard offers you two additional years of hardware service (Option W30) for less than four percent of the purchase price of the DMM.

### Performance

Selectable speed and resolution provide the right capability for your measurement. The HP 3478A can perform production tests or acquire experimental data at 90 readings/s with 3½ digit resolution, or take 35 readings/s with 130 dB of noise rejection using 4½ digits. The 5½ digit mode offers 100 nVdc and 100 μΩ resolution for precise measurements. True rms with 300 kHz bandwidth and 4:1 crest factor provides reliable measurements of ac signals. Fast autoranging makes the first reading useful and accurate.

### Designed for Systems

Switchable front/rear inputs permit flexible system connections. The Voltmeter Complete output and External Trigger input allow synchronization of the HP 3478A with a scanner for fast multiplexed measurements without the delay of software commands. The test program can write prompt messages or results on the alphanumeric display. The operator can respond by pressing the HP 3478A's SRQ key to interrupt the controller and start the next test. Built-in self-test capability assures proper operation.

### Electronic Calibration

Complete calibration of the HP 3478A is accomplished without any internal adjustment or removing the instrument's covers. Either manually, from the front panel, or automatically over HP-IB, calibration is fast and easy. Connect your standards to the HP 3478A and, during calibration, the calibration constants are stored in the

HP 3478A's non-volatile memory. The result is less calibration error and lower calibration costs.

### Specifications

#### DC Voltage

##### Input Characteristics

Range	Maximum Reading (5½ digit)	Resolution		
		5½ digit	4½ digit	3½ digit
30 mV	±30.3099 mV	100 nV	1 μV	10 μV
300 mV	±303.099 mV	1 μV	10 μV	100 μV
3 V	±3.03099 V	10 μV	100 μV	1 mV
30 V	±30.3099 V	100 μV	1 mV	10 mV
300 V	±303.099 V	1 mV	10 mV	100 mV

**Input resistance:** 30 mV, 300 mV, 3 V ranges:  $>10^{10} \Omega$   
30 V, 300 V ranges:  $10 \text{ M}\Omega \pm 1\%$

**Maximum input voltage** (non-destructive): Hi to Lo: 303 Vrms or 450 V peak; Hi or Lo to Earth Ground:  $\pm 500 \text{ V peak}$

**Measurement accuracy:**  $\pm(\%$  of reading + number of counts). Auto zero ON.

#### 5½ Digit Mode

Range	$T_{\text{Cal}} \pm 1^\circ \text{C}$			$T_{\text{Cal}} \pm 5^\circ \text{C}$		
	24 Hour	90 Day	1 Year	24 Hour	90 Day	1 Year
30 mV	0.025 + 40	0.0275 + 40	0.035 + 40	0.025 + 40	0.0275 + 40	0.035 + 40
300 mV	0.004 + 4	0.005 + 5	0.007 + 5	0.004 + 4	0.005 + 5	0.007 + 5
3 V	0.003 + 2	0.004 + 2	0.006 + 2	0.003 + 2	0.004 + 2	0.006 + 2
30 V	0.004 + 3	0.005 + 4	0.007 + 4	0.004 + 3	0.005 + 4	0.007 + 4
300 V	0.004 + 2	0.005 + 2	0.007 + 2	0.004 + 2	0.005 + 2	0.007 + 2

\* $T_{\text{Cal}}$  is the temperature of the environment where the HP 3478A was calibrated. Calibration should be performed with the temperature of the environment between  $20^\circ \text{C}$  and  $30^\circ \text{C}$ . 24 hour accuracy relative to calibration standards.

**4½ and 3½ digit mode:** accuracy is the same as 5½ digit mode for % of reading; use 1 count for number of counts on all ranges except 30 mV, use 4 counts.

**Math Functions:** The HP 3457A performs the following math functions on the measurements—NULL, SCALE, OFFSET, RMS FILTER, SINGLE POLE FILTER, THERMISTOR LINEARIZATION, DB, DBM, % ERROR, PASS?FAIL LIMIT TESTING, and STATISTICS. Two math functions may be used at one time.

**General Specifications**

**Operating Temperature:** 0 to 55° C  
**Warmup Time:** one hour to all specifications except where noted  
**Humidity Range:** 95% RH, 0 to 40° C  
**Storage Temperature:** -40 to +75° C  
**Power:** 100/120/220/240 V ±10%, 48 Hz - 66 Hz, 220 V, ±10%, 48 Hz to 66 Hz. Fused at .2A (115 V) or 0.08 A (230 V), <30 VA.  
**Size:** 89 H (without removable feet) x 425 W x 292mm D (3.5" x 16.75" x 11.5"). Height (with removable feet): 100 mm (4"). Allow 76mm (3") additional depth for wiring.  
**Net Weight:** 5.05 kgm (11.1 lbs)  
**Shipping Weight:** 9.3 kgm (20.5 lbs)

**Plug-in Options**

**HP 44491A Armature Relay Multiplexer Assembly Input Characteristics:** Eight two-wire armature relay channels and two current/actuator channels. Maximum voltage (terminal-to-terminal or terminal to chassis) 250 Vrms. Maximum current (per channel) -1.0 A DC or AC. Thermal Offset - 3μ V. Closed channel resistance (end of relay life) - <2 Ohms. Maximum switching and measurement speed - 33 channels/second.

**HP 44492A Reed Relay Multiplexer Assembly Input Characteristics:** Ten two-wire reed relay channels. Maximum voltage (terminal-to-terminal or terminal-to-chassis) - 125 V peak. Thermal offset - 3 μV. Closed channel resistance (end of relay life) - <4 Ohms. Specified for <100 kHz ac volts and frequency operation. Maximum switching and measurement speed - 300 channels/second.

**HP 44497A High Voltage Attenuator Assembly Input Characteristics:** Two relay channels, channel 1 devoted to high voltage measurements. Maximum High-to-Low voltage of 1000 volts dc or ac rms. Maximum Low-to-Earth voltage of 350 V Peak Non-destructive Overload voltage of 1700 V Peak, 1200 volts dc. Attenuator accuracy to be added to HP 3457A range and function accuracy for total accuracy.

dc	0.030% of reading
20 Hz - 1 kHz	2.8% of reading
1 kHz - 10 kHz	10.0% of reading

Note: One year accuracy applies to Tcal ±5%, NPLC=1 or greater. Specifications are for low-to-earth voltage less than 0.1 times the High-to-Earth voltage.

**Ordering Information**

	<b>Price</b>
<b>HP 3457A Multimeter</b>	<b>\$3100</b>
*HP 44491A Armature Relay Multiplexer Assembly	\$545
*HP 44492A Reed Relay Multiplexer Assembly	\$545
*HP 44497A High Voltage Attenuator Assembly	\$545
Opt 401 Side Handle Kit (5061-1171)	+\$45
Opt 700 CIIL Language	+\$1000
Opt 907 Front Handle Kit (5061-1170)	+\$70
Opt 908 Rack Flange Kit (5061-1168)	+\$35
Opt 909 Rack Flange and Front Handle Kit (5061-1169)	+\$85
Opt 910 Extra Operating and Service Manual	+\$110
Option W30 Extended repair service. See page 723.	+\$80

**Accessories**

HP 44490A Rack Slide Kit for 30 inch depth racks	\$250
HP 44493A Screw Terminal Connector for HP 44491A includes strain relief and housing	\$65
HP 44494A Screw Terminal Connector for HP 44492A includes strain relief and housing	\$65
HP 34118A Test Lead Kit	\$30
HP 34301A RF Detector Probe, 100 kHz to 700 MHz	\$80
HP 34300A 40 kV ac/dc Probe, dc to 300 Hz	\$90
HP 34119A High Voltage Probe, 1000:1, ac & dc Voltage Divider for up to 5000V	\$130
HP 44414A: Four Thermistor Pack	\$63

\*Plug-in options may be ordered and shipped separately without a HP 3457A mainframe. Unless otherwise specified, the optional plug-in accessories will be shipped with the HP 3457A mainframe.

☎ For same-day shipment, call HP DIRECT at 800-538-8787.

Armature Relay (44491A)

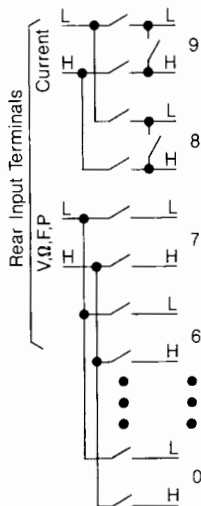

Reed Relay (44492A)

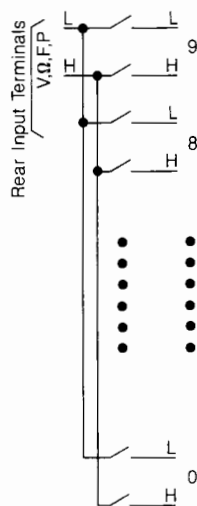

# DIGITAL MULTIMETERS

3<sup>1</sup>/<sub>2</sub> to 6<sup>1</sup>/<sub>2</sub> Digit DMM with Extended Resolution to 7<sup>1</sup>/<sub>2</sub> Digits (cont'd)

HP 3457A

## Abbreviated Technical Specifications

90 day, Tcal ± 5 deg. C

### DC Voltage

Range	Maximum Reading	Best 6 <sup>1</sup> / <sub>2</sub> Digit Accuracy <sup>1</sup> ± (% Rdg + Cnts)		
		% of Reading	Count Error	Input Resistance
30 mV	30.03000 mV	0.0040	365	10 GΩ
300 mV	303.0000 mV	0.0025	39	10 GΩ
3.0 V	3.030000 V	0.0017	6	10 GΩ
30.0 V	30.30000 V	0.0035	19	10 MΩ
300.0 V	303.0000 V	0.0050	6	10 MΩ

1. After 1 hr warm-up, integration time 100 PLC. Tcal is the temperature of the calibration environment between 18 and 28 deg C.

### DC Current

Range	Maximum Reading	Best 6 <sup>1</sup> / <sub>2</sub> Digit Accuracy <sup>1</sup> ± (% Rdg + Cnts)		
		% of Reading	Count Error	Input Resistance
300 μA	303.0000μA	0.02	104	1000Ω
3 mA	3.030000 mA	0.02	104	100Ω
30 mA	30.30000 mA	0.02	104	10Ω
300 mA	303.0000 mA	0.07	204	1Ω
1.0A	1.000000 A	0.07	604	0.1Ω

1. After 1 hr warm-up, integration time 100 PLC. Tcal is the temperature of the calibration environment between 18 and 28 deg C.

### Resistance (2 and 4 wire ohms)<sup>2</sup>

Range	Maximum Reading	Best 6 <sup>1</sup> / <sub>2</sub> Digit Accuracy <sup>1</sup> ± (% Rdg + Cnts)		
		% of Reading	Count Error	Current Output
30 Ohm	30.30000 Ohm	0.0065	315	1 mA
300 Ohm	303.0000 Ohm	0.0045	34	1 mA
3 kOhm	3.030000 kOhm	0.0035	6	1 mA
30 kOhm	30.30000 kOhm	0.0035	6	100 μA
300 kOhm	303.0000 kOhm	0.0040	7	10 μA
3 MOhm	3.030000 MOhm	0.0055	12	1 μA
30 MOhm	30.30000 MOhm	0.0250	80	100nA
300 MOhm <sup>3</sup>	303.0000 MOhm	1.6	1000	100nA
3.0 GOhm <sup>3</sup>	3.030000 GOhm	16.0	1000	100nA

- After 1 hr warm up, integration time 100 PLC. Tcal is the temperature of the calibration environment between 18 and 28 deg C.
- For two-wire ohms, add 200m Ohms to count error specifications.
- For two-wire ohms only, Accuracy is specified following autocal (ACAL), under stable conditions (±1 deg C).

**Maximum Reading Rates (DCV, DCI, and Resistance up to 30 kOhm)<sup>2</sup>**

Power Line Cycles <sup>3</sup>	Maximum # of Digits	Readings per Second-60Hz (50Hz)		
		Auto Zero On	Auto Zero Off	NMR
.0005	3 <sup>1</sup> / <sub>2</sub>	300	1350	0
.005	4 <sup>1</sup> / <sub>2</sub>	280	1250	0
.1	5 <sup>1</sup> / <sub>2</sub>	140 (128)	360 (312)	0
1.0	6 <sup>1</sup> / <sub>2</sub>	26 (22)	53 (45)	60dB
10	7 <sup>1</sup> / <sub>2</sub> <sup>4</sup>	2.5 (2.0)	4.8 (4.0)	80dB
100	7 <sup>1</sup> / <sub>2</sub> <sup>2</sup>	.25 (0.2)	0.5 (0.4)	90dB

- Using Math HIRES mode.
- Reading rates are specified with zero delay, fixed range, display off, and front panel off. The output is to internal reading memory using single integer format and internal timer.
- Integration Time in Power Line Cycles (PLC).

**Common Mode Rejection (dB):** (1 kOhm unbalance in low lead) DC ECMR 140 dB; AC ECMR: <1 PLC, 76 dB; AC ECMR >1 PLC 156 dB, for 50, 60 Hz ±.08%.

### True RMS ACV and (AC+DC)V

**Bandwidth:** 20 Hz to 1 MHz

**Crest Factor:** 3.5 to 1 at full scale

**Common Mode Rejection:** (1 kOhm unbalance in LO): >76 dB, DC to 60 Hz

**Accuracy:** (90 day)

Accuracy specified for sine wave inputs, >10% of range. DC component <10% of AC component after 1 hr warm-up and within one week of autocal. Integration time = 10 PLC. AC Band set to <400 Hz. DC coupled mode requires 2 hour warm-up.

Range	Maximum Reading	(100 Hz to 20 kHz) Best 5 <sup>1</sup> / <sub>2</sub> Digit Accuracy ± (% Rdg + Cnts)			
		AC Coupled % of Reading	Count Error	DC Coupled % of Reading	Count Error
30mV	32.50000mV	0.13	116	0.17	364
300mV	325.0000mV	0.13	116	0.17	364
3.0V	3.250000 V	0.13	116	0.17	364
30.V	32.50000 V	0.13	116	0.17	364
300V	303.0000 V	0.19	116	0.23	364

### True RMS ACI and (AC+DC)I

**Bandwidth:** 20 Hz to 100 kHz Crest Factor: 3.5 to full scale

**Accuracy:** (90 day)

Accuracy specified for sine wave inputs, >10% of range. DC component <10% of AC component after 1 hr warm-up and within one week of autocal. Integration time = 10 PLC. AC Band set to <400 Hz. DC coupled mode requires 2 hour warm-up.

Range	Maximum Reading	(100 Hz to 20 kHz) Best 5 <sup>1</sup> / <sub>2</sub> Digit Accuracy ± (% Rdg + Cnts)			
		AC Coupled		DC Coupled	
		% of Reading	Count Error	% of Reading	Count Error
30mA	32.50000mA	0.25	290	0.3	1600
300mA	325.0000mA	0.25	290	0.3	1600
1.0A	1.000000 A	0.35	290	0.4	1600

### Reading Rates (ACV and ACI)<sup>1</sup>

Power Line Cycles	Maximum # of Digits	Readings per Second .60 Hz (50 Hz)	
		Input <400 Hz (Slow Response)	Input >400 Hz (Fast Response)
.0005	3 <sup>1</sup> / <sub>2</sub>	1	9.5
.005	4 <sup>1</sup> / <sub>2</sub>	1	9.5
.1	5 <sup>1</sup> / <sub>2</sub>	1 (1)	9.25 (9.2)
1	6 <sup>1</sup> / <sub>2</sub>	1 (1)	7.25 (6.9)
10	6 <sup>1</sup> / <sub>2</sub>	0.7 (0.65)	2.0 (1.7)
100	6 <sup>1</sup> / <sub>2</sub>	0.2 (0.17)	0.25 (0.2)

1. Reading rates are specified with preprogrammed delays, fixed range, and Auto Zero on.

**Frequency and Period:** Measures the frequency or period of the ac component of the ac or dc coupled voltage or current input. The counter uses a reciprocal counting technique to give constant resolution independent of input frequency.

**Input Impedance:** Refer to AC voltage and current specifications.

**Frequency Range:** 10 Hz to 1.5 MHz (voltage input)  
10 Hz to 100 KHz (current input)

**Period Range:** .1 s to 667 ns (voltage input)  
.1 s to 3.33 us (current input)

**Sensitivity:** 10 mV or 100 μA (sinewave)

**Triggering:** Triggers and counts on zero crossings

**Accuracy:** (1 year)

Frequency	Period	± % of Reading
10 Hz to 400 Hz	.1 s to .025 s	0.05
400 Hz to 1.5 MHz	.025 s to 667 ns	0.01

**Maximum Reading Rate:** 2.0 rdgs/s for integration time of 1 PLC, AC Band >400 Hz, delay zero and math off, and fixed range.

**Memory:** 2139 available bytes that can be partitioned into 3 segments, one devoted to storing measurements, one devoted to storing measurement subprograms, and one devoted to storing instrument states.

# DIGITAL MULTIMETERS

3<sup>1</sup>/<sub>2</sub> to 6<sup>1</sup>/<sub>2</sub> Digit DMM with Extended Resolution to 7<sup>1</sup>/<sub>2</sub> Digits

HP 3457A

89

- Over 1350 readings/sec at 3<sup>1</sup>/<sub>2</sub> digits
- Seven Functions—dcV, acV, dcl, acI, ohms, Frequency and Period

- Three plug-in multiplexer options
- dc sensitivity to 10 nanovolts
- Outstanding combination of performance and price

DESIGNED FOR  
MATE  
SYSTEMS

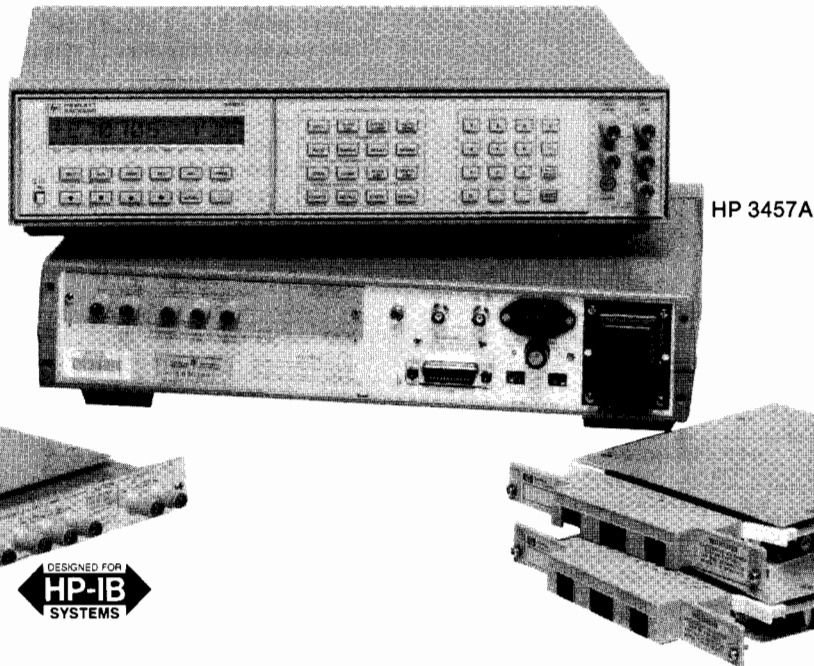

## HP 3457A Digital Multimeter

The HP 3457A has seven functions with 3<sup>1</sup>/<sub>2</sub> to 6<sup>1</sup>/<sub>2</sub> digits of resolution extendable to 7<sup>1</sup>/<sub>2</sub> digits at reading rates from 1 reading every 2 seconds to 1350 rds/s and basic DC volts accuracy as good as 5 ppm. In addition, the input of the HP 3457A can be expanded up to ten channels with either of the optional plug-in multiplexer assemblies. On the bench, the front panel operation is extremely flexible and comprehensive. In systems, the Hewlett-Packard Interface Bus (HP-IB) is standard.

## Powerful Measurement Management

The HP 3457A combines superb analog measuring capability with equally powerful measurement management. More than 1000 readings or whole measurement sequences can be stored in the HP 3457A for convenient and fast measurement throughput. The present dmm setup can be stored in the non-volatile state memory for convenient reconfiguration of the dmm.

Additional power from math functions can be obtained by using PASS/FAIL limit testing, NULL, SCALE, THERMISTOR linearization, and others. The power of total electronic calibration, including ac volts, makes it easy to maintain instrument performance.

## System Features

Keeping with HP's long tradition of systems oriented digital multimeters, the HP 3457A has all the systems features you've come to expect plus more to make interfacing to your computer even easier—features like flexible formatting of ASCII, 16 bit binary, or 32 bit binary data and buffer memory so that you can take measurements with the HP 3457A at its highest speed. In addition, you'll find the VOLT METER COMPLETE output and EXTERNAL TRIGGER input signals ideal for synchronizing other instrumentation with the HP 3457A. Finally, programmable front-rear terminal switching lets you measure two separate inputs without a scanner.

## Hewlett-Packard Multimeter Language (HPML)

Another first for the HP 3457A DMM is an easy-to-use dmm language—HPML. Designed so that software written for today's multimeter will fit tomorrow's, HPML only asks you to define the parameters necessary to accomplish your measurement. For example, if you want to make a measurement on a 9 volt dc signal with 0.01% resolution, the command sequence is "DCV,9,.01".

## Control Interface Intermediate Language (CIIL)

With Option 700, the HP 3457A responds to standardized DMM CIIL commands via HP-IB. Physically and functionally identical to the standard HP 3457A, Option 700 adds the CIIL command set with a built-in Test Module Adapter (TMA) to the DMM's standard HPML. The HP 3457A is further enhanced by adding the functions of ac and dc current measurement through CIIL through HP-IB.

## Three Rear-Panel Plug-In Options

Either one of three different optional assemblies may be used with the HP 3457A for different measurement capabilities. Using the multiplexer assemblies will enable up to ten signal channels to be scanned either sequentially or randomly. All of the functional capability offered through the normal front and rear input terminals is available for multiple inputs. Using the high voltage assembly allows single channel measurement of either ac or dc voltages at the rear panel.

For measurement flexibility, the HP 44491A Armature Relay Multiplexer Assembly offers eight two-wire channels and two current/actuator channels. Under software control, the eight two-wire channels can be reconfigured to four 4-wire ohm channels. The two current channels offer automatic make-before-break switching so that the path for current as high as 1.5 A is never broken. In addition, these two channels can be used as external device actuator channels. Each channel can switch up to 150 V. The general purpose multiplexer can close a channel and make a measurement at a maximum rate of 33 channels per second.

For higher speed scanning, the HP 44492A Reed Relay Multiplexer Assembly offers ten two-wire channels. The HP 44492A is useful for switching Vdc, Vac, two wire ohms, frequency and period measurement signals with a maximum amplitude of 125 V. The Reed Relay Multiplexer can close a relay and make a measurement at a maximum rate of 300 channels per second.

For measurement of voltages up to 1414 V peak, the HP 44497A High Voltage Assembly offers a 1000:1 attenuator input (channel 1) for the high voltage measurements. In addition, the other rear terminal input (channel 0) can be utilized to perform conventional Vdc, Vac, two-wire and four-wire ohms, period, frequency, dcl, and acI measurements. Using the HP 44497A with HP 3457A in the 6<sup>1</sup>/<sub>2</sub> digit mode will yield a resolution of 1 mV for a 1000 V input. Implementing the MATH Scale function will have the HP 3457A LCD display the measurement results in the correct units of kilovolts.

# DIGITAL MULTIMETERS

## A System Multimeter with Both High Speed and Accuracy (cont'd)

HP 3458A

### AC Voltage (Synchronously Sub-sampled Mode)

Range	Full Scale	Maximum Resolution	Input Impedance	Accuracy		Conditions
				24 hr to 2 Year 40 Hz to 1 kHz (% of Reading + % of Range)		
10 mV	12.00000	10 nV	1 MΩ ±15% with <140 pF	0.02 + 0.011		<ul style="list-style-type: none"> <li>Specifications apply full scale to 10% of full scale, dc &lt;10% of ac, sine wave input, crest factor = 1.4. Within 24 hours and ±1°C of last ACAL.</li> <li>Peak (ac + dc) input limited to 5 x full scale for all ranges in ACV function.</li> <li>Add 2 ppm of reading additional error for HP factory traceability of 10 V dc to US NIST.</li> </ul>
100 mV	120.0000	100 nV	1 MΩ ±15% with <140 pF	0.007 + 0.002		
1 V	1.200000	1 μV	1 MΩ ±15% with <140 pF	0.007 + 0.002		
10 V	12.00000	10 μV	1 MΩ ±2% with <140 pF	0.007 + 0.002		
100 V	120.0000	100 μV	1 MΩ ±2% with <140 pF	0.02 + 0.002		
1000 V	1050.000	1 mV	1 MΩ ±2% with <140 pF	0.04 + 0.002		

### Maximum Input

	Rated Input	Non-Destructive
HI to LO	±1000 V pk	±1200 V pk
LO to Guard	±200 V pk	±350 V pk
Guard to Earth	±500 V pk	±1000 V pk
Volt-Hz Product	1 x 10 <sup>8</sup>	

### Front/Rear Panel Description

#### Display

- Bright, easy-to-read, vacuum fluorescent display
- 16-character alphanumeric display to easily read data, messages, and commands

#### Standard function/range keys

- Simple to use, for bench measurements of dcV, acV, Ohms, current frequency and period
- Select autorange or manual ranging

#### Menu command keys

- Immediate access to eight common commands
- Shifted keys allow simple access to complete command menu

#### Numeric/user keys

- Numeric entry for constants and measurement parameters
- Shifted keys (f0 through f9) access up to ten user-defined setups.

#### Volts/ohms/ratio terminals

- Gold-plated tellurium copper for minimum thermal emf
- 2-wire or 4-wire Ohms measurements
- dc/dc or ac/dc ratio inputs

#### Current measurement terminals

- Easy fuse replacement with fuseholder built into terminal

#### Guard terminal and switch

- For maximum common mode noise rejection

#### Front-rear terminal switch

- Position selects front or rear measurement terminals

### External Output

- Programmable TTL output pulse with 5 modes for flexible system interface

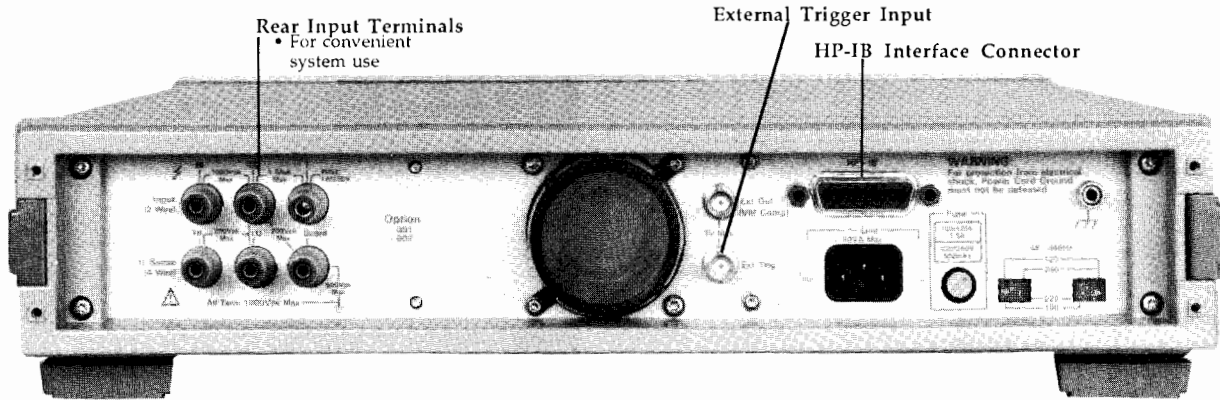

### Throughput

#### Maximum Reading Rates

- 100,000 readings/s at 4½ digits (16 bits)
- 50,000 readings/s at 5½ digits
- 6,000 readings/s at 6½ digits
- 60 readings/s at 7½ digits
- 6 readings/s at 8½ digits

#### Measurement System Speed

- 100,000 readings/s over HP-IB or with internal memory
- 110 autoranges/s
- 200 function or range changes/s
- Post-processed math from internal memory

### Ordering Information

HP 3458A Multimeter (with HP-IB, 20 kbytes reading memory, and 8 ppm stability)	\$6110
Opt 001 Extended Reading Memory (Expands total to 148k bytes)	+\$530
Opt 002 High Stability (4 ppm/year) Reference	+\$1000
Opt 005 Waveform Analysis Library for HP Series 300 Computers with BASIC 4.0 or greater	+\$400
Opt W30 Two additional years Return-to-HP hardware support. See page 723.	+\$160
Opt 700 CIIL Language	+\$1000
Opt 907 Front Handle Kit	+\$60
Opt 908 Rack Flange Kit	+\$35
Opt 909 Rack Flange Kit (with handles)	+\$85

DC Voltage				Accuracy		Transfer Accuracy	
Range	Full Scale	Maximum Resolution	Input Impedance	1 Year (ppm of Reading + ppm of Range)	Conditions	10 Min Tref ±0.5°C (ppm of Reading + ppm of Range)	Conditions
100 mV	120.00000	10 nV	10 GΩ	9 + 10	<ul style="list-style-type: none"> <li>Specifications for NPLC 100 within 24 hours and ±1°C of last ACAL; TCAL +5°C.</li> <li>For High stability (Option 002) subtract 1.5 ppm of Reading from 90 day, and 4 ppm of Reading from 1 or 2 year accuracy.</li> <li>Add 2 ppm of reading additional error for HP factory traceability of 10 V dc to US NIST. Traceability error is the absolute error relative to National Standards associated with the source of last external calibration.</li> </ul>	0.5 + 0.5	<ul style="list-style-type: none"> <li>NPLC = 100</li> <li>Following 4 hour warm-up. Full scale to 10% of full scale.</li> <li>Measurements on the 1000 V range are within 5% of the initial measurement value and following measurement setting.</li> <li>Tref is the starting ambient temperature.</li> <li>Measurements are made on a fixed range using accepted metrology practices.</li> </ul>
1 V	1.20000000	10 nV	10 GΩ	8 + 1		0.3 + 0.1	
10 V	12.0000000	100 nV	10 GΩ	8 + 0.2		0.05 + 0.05	
100 V	120.000000	1 μV	10 MΩ ±1%	10 + 0.3		0.5 + 0.1	
1000 V	1050.00000	10 μV	10 MΩ ±1%	10 + 0.1		1.5 + 0.05	

**Noise Rejection (dB)<sup>1</sup>**

	AC NMR <sup>2</sup>	AC ECMR	DC ECMR
NPLC <1	0	90	140
NPLC ≥1	60	150	140
NPLC ≥10	60	150	140
NPLC ≥100	70	160	140
NPLC = 1000	80	170	140

<sup>1</sup>Applies for 1 kΩ unbalance in the LO lead and ±0.1% of the line frequency currently set for LFREQ.

<sup>2</sup>For line frequency ±1%, ACNMR is 40 dB for NPLC ≥1, or 80 dB for NPLC ≥ 100. For line frequency ±5%, ACNMR is 65 dB for NPLC ≥ 100.

**Maximum Input**

	Rated Input	Non-Destructive
HI to LO	±1000 V pk	±1200 V pk
LO to Guard	±100 V pk	±350 V pk
Guard to Earth	±500 V pk	±1000 V pk

**Resistance**

Range	Accuracy Four-Wire Ohms <sup>1</sup>	
	One Year (ppm of Reading + ppm of Range)	Conditions
10 Ω	15 + 5	<ul style="list-style-type: none"> <li>100 power line cycle integration, offset compensation on.</li> <li>Within 24 hours and ±1°C of last ACAL; Tcal ±5°C.</li> <li>Add 3 ppm of reading additional error for HP factory traceability of 10 kΩ to US NIST. Traceability is the absolute error relative to National Standards associated with the source of last external calibration.</li> </ul>
100 Ω	12 + 5	
1 kΩ	10 + 0.5	
10 kΩ	10 + 0.5	
100 kΩ	10 + 0.5	
1 MΩ	15 + 2	<ul style="list-style-type: none"> <li>Add 3 ppm of reading additional error for HP factory traceability of 10 kΩ to US NIST. Traceability is the absolute error relative to National Standards associated with the source of last external calibration.</li> </ul>
10 MΩ	50 + 10	
100 MΩ	500 + 10	
1 GΩ	0.5% + 10	

<sup>1</sup>Two-Wire Ohms Accuracy Add 250 mΩ to the four-wire ohms accuracy.

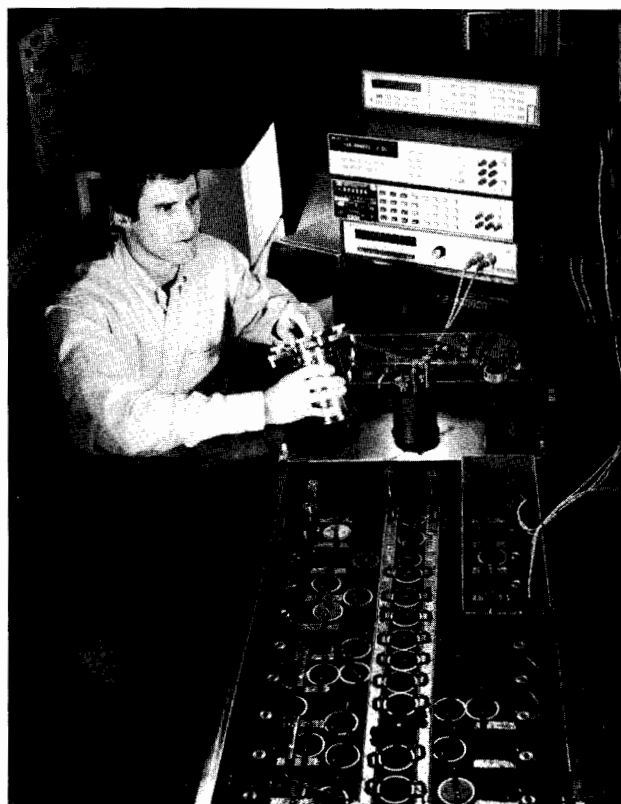



# DIGITAL MULTIMETERS

## A System Multimeter with Both High Speed and High Accuracy

### HP 3458A

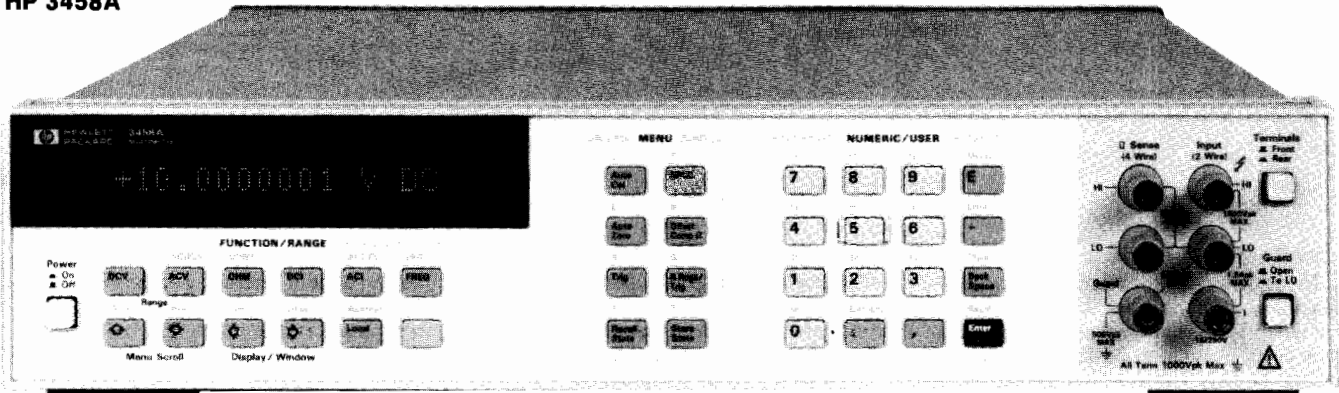

DESIGNED FOR  
MATE  
SYSTEMS



HP 3458A

The HP 3458A multimeter shatters long-standing performance barriers of speed and accuracy on the production test floor, in R&D, and in the calibration lab. The HP 3458A is simply the fastest, most flexible, and most accurate multimeter ever offered by Hewlett-Packard. In your system or on the bench, the HP 3458A saves you time and money with unprecedented test system throughput and accuracy, seven function measurement flexibility, and low cost of ownership.

Select a reading rate of 100,000 readings per second for maximal test throughput. Or achieve highest levels of precision with up to 8½ digits of measurement resolution and 0.1 part per million transfer accuracy. Add to this, programming compatibility through the Hewlett-Packard Multimeter Language (HPML) and the HP 3458A's simplicity of operation and you have the ideal multimeter for your most demanding applications.

### High Test System Throughput

#### Faster Testing

- Up to 100,000 readings/s
- Internal test setups >200/s
- Programmable integration times from 500 ns to 1 s

#### Greater Test Yield

- More accuracy for tighter test margins
- Up to 8½ digits resolution

#### Longer Up-Time

- Two-source (10V, 100kΩ) calibration, including ac
- Self-adjusting, self-verifying auto-calibration for all functions and ranges, including ac

### High Resolution Digitizing

#### Greater Waveform Resolution and Accuracy

- 16 bits at 100,000 samples/sec
- 18 bits at 50,000 samples/sec
- 12 MHz bandwidth
- Timing resolution to 10 ns
- Less than 100 ps time jitter
- Over 75,000 reading internal memory

#### Flexible Digitizing Software

- Powerful, easy-to-use analysis software for HP 9000 Series 200/300 Computers
- Subprograms for waveform acquisition, data transfer, FFT, IFT, and data presentation

### Calibration Lab Precision

#### Superb Transfer Measurements

- 8½ digits resolution
- 0.1 ppm dc Volts linearity
- 0.1 ppm dc Volts transfer capability
- 0.01 ppm rms internal noise

#### Extraordinary Accuracy

- 0.6 ppm for 24 hours in dc Volts
- 2.2 ppm for 24 hours in Ohms
- 100 ppm mid-band ac Volts
- 8 ppm (4 ppm optional) per year voltage reference stability

### HP 3458A Multimeter Performance Features

#### DC Volts

- 5 ranges: 0.1 V to 1000 V
- 8½ to 4½ digit resolution
- Up to 100,000 readings/s (4½ digits)
- Maximum sensitivity: 10 nV
- 0.6 ppm 24 hour accuracy
- 8 ppm (4 ppm optional)/year voltage reference stability

#### Ohms

- 9 ranges: 10Ω to 1GΩ
- Two-wire and four-wire Ω with offset compensation
- Up to 50,000 readings/s (5½ digits)
- Maximum sensitivity: 10μΩ
- 2.2 ppm 24 hour accuracy

#### AC Volts

- 6 ranges: 10 mV to 1000 V
- 1 Hz to 10 MHz bandwidth
- Up to 50 readings/s with all readings to specified accuracy
- Choice of sampling or analog true rms techniques
- 100 ppm best accuracy

#### DC Current

- 8 ranges: 100 nA to 1 A
- Up to 3,500 readings/s (5½ digits)
- Maximum sensitivity: 1 pA
- 13 ppm 24 hour accuracy

#### AC Current

- 5 ranges: 100 μA to 1 A
- 10 Hz to 100 kHz bandwidth
- Up to 50 readings/s
- 500 ppm 24 hour accuracy

#### Frequency and Period

- Voltage or current ranges
- Frequency: 1 Hz to 10 MHz
- Period: 100 ns to 1 s
- 0.01% accuracy
- ac or dc coupled

### Low Cost of Ownership

In addition to flexibility and multi-functional capability, HP DMMs are noted for reliability. From concept to implementation, every phase of designing and manufacturing DMMs has resulted in extremely reliable products. Your DMM reliability is directly reflected in test system up-time and

your total cost of ownership. As a result, we offer electronic no-pots calibration to maximize your system up-time. Designed-in modularity and self-test capabilities keep repair time and costs to a minimum.

The reliability of HP products is so good that we offer three years of hardware support

for all of our system DMMs at a low incremental price. Therefore, you can expect HP's reliability and support to keep your test system up and running for a long time. As a result of HP's commitment to quality, you can benefit by reducing your total cost of ownership when purchasing HP DMMs.

HP Model	HP 3458A page 86	HP 3457A page 89	HP 3478A page 92	HP 3456A page 94	HP 3437A page 95	HP 3455A page 95	HP 3468A/B page 96	HP 3466A page 98	HP E2377A/ E2378A page 100
<b>dc voltage</b>									
Accuracy 1 yr best full scale (parts per million)	5.1 (Opt 002)	27	67	25	2300	130	187	350	3667
Resolution (nanovolts)	10	10	100	100	100,000	1000	1000	1000	100,000
Maximum reading rate at 5 1/2 digits (readings per second)	50,000	360	4.4	210	—	24	3.7	4.7	—
Maximum range (volts)	1000	1000 (HP 44497A)	300	1000	10	1000	300	1200	1000
<b>Resistance</b>									
Accuracy 1 yr best full scale (parts per million)	10.5	52	167	86	—	50	160	300	
Resolution (microhms)	10	10	100	100	—	1	1000	1000	
<b>ac voltage</b>									
Bandwidth	1 Hz to 10 MHz	20 Hz to 1 MHz	20 Hz to 300 kHz	20 Hz to 250 kHz	—	30 Hz to 250 kHz	20Hz to 300 kHz	20 Hz to 100 kHz	40 Hz to 1 kHz
<b>Functions</b>	dc & ac V, 2- & 4-wire $\Omega$ , offset-compensated $\Omega$ , dc & ac I, frequency, period, math, test-sequence storage, ratio, 20 kbytes reading memory, digitizing, & HP-IB	dc & ac V, 2- & 4-wire $\Omega$ , offset-compensated $\Omega$ , dc & ac I, frequency, period, math, test-sequence storage, 1 kbyte reading memory, & HP-IB	dc & ac V, 2- & 4-wire $\Omega$ , dc & ac I, & HP-IB	dc & ac V, 2- & 4-wire $\Omega$ , offset-compensated $\Omega$ , math, ratio, HP-IB	dc V, HP-IB	dc & ac V, 2- & 4-wire $\Omega$ , math, HP-IB	dc & ac V, 2- & 4-wire $\Omega$ , dc & ac I, HP-IL	dc & ac V, 2-wire $\Omega$ , Ohms zero adjust, dc & ac I, diode test	dc & ac V, dc & ac I 2-wire $\Omega$ , diode test, audio continuity, temp (K-Type), & data hold
<b>Options</b>	Opt 001 Expanded reading memory to 148 kbytes, Opt 002 High stability (4 ppm/yr), Opt 005 Waveform analysis library Opt 700 CILL Language Opt W30 3 yr hardware support	Opt 700 CILL Opt W30 3 yr hardware support 44497A 1000 V attenuator 44491A Armature relay mux 44492A Reed relay mux	Opt W30 3 yr hardware support	Opt 050 - noise rejection for 50 Hz Opt 060 - noise rejection for 60 Hz Opt W30 - 3 yr hardware support	Opt W30 3 yr hardware support	Opt 001 average converter	Opt 001 rechargeable battery pack Opt W30 3 yr. hardware support	Opt 001 streamlined portable case	E2301A surface thermocouple probe K-Type E2302A airflow thermocouple probe K-Type E2303A thermocouple probe adapter E2305A replacement test leads
<b>Price</b>	\$6,110	\$3,100	\$995	\$5,695	\$4,395	\$7,295	\$820	\$1,580	\$169/189

# DIGITAL MULTIMETERS

## General Information

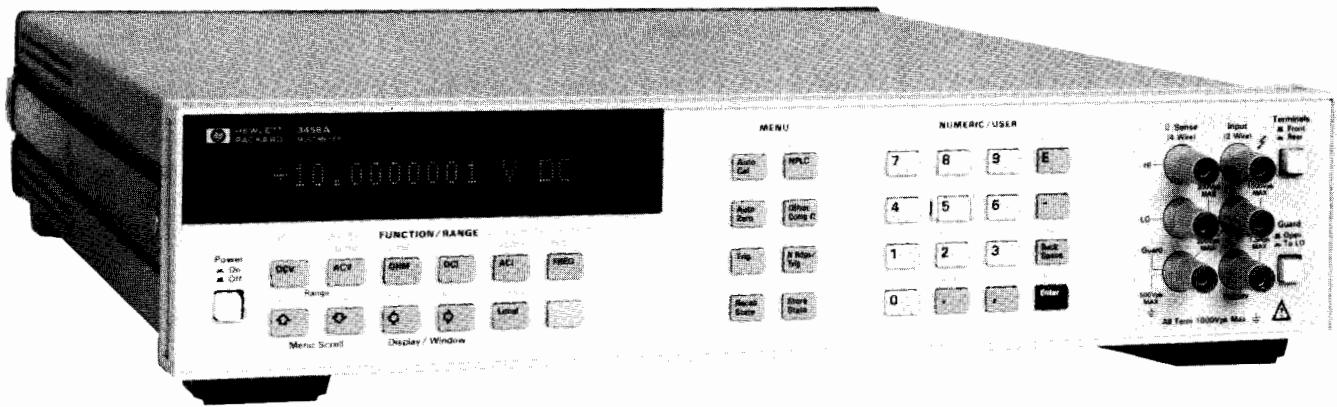

### Digital Multimeters

Hewlett-Packard offers a wide range of digital multimeters (DMMs) to meet test and measurement requirements. HP has a DMM with the measurement capability you need for data acquisition, production or research testing.

The combination of precise measurement and versatile configuration capabilities in HP DMMs gives you meaningful measurements of your product or process. This enables you to interpret results and make decisions that improve productivity and quality. You can perform dc and ac tests of voltage and current, and measure resistance using two or four terminals. Frequency and period measurements are also available on some multimeters.

Measurement-driven applications in calibration and metrology/standards labs need the accuracy and stability of the HP 3458A. The digitizing capabilities of the HP 3458A

also enable you to use this multimeter in high-resolution digitizing applications.

Computer-aided production testing requires a wide variety of functions, resolutions, and speeds; the HP 3457A fits those needs. Many of your bench measurement problems are handled by the HP 3468A/B, a high-performance 5 $\frac{1}{2}$ -digit, five-function DMM.

For low-cost HP-IB systems, the HP 3478A provides five measurement functions with the performance to meet many system requirements. For portable troubleshooting, the HP E2300 series of handheld multimeters offers you HP quality in a 3 $\frac{1}{2}$ -digit handheld.

### Measurement Performance Tradeoffs

In some applications, measurement speed is the most important requirement. Other applications demand high accuracy, high reso-

lution, and excellent noise rejection. Often your requirements are somewhere in-between. HP's innovative integration techniques used in most of its DMMs can trade speed for resolution, which adds measurement flexibility.

HP's integrating DMMs offer the fastest reading rates available with power line-related noise rejection. Integration selection (number of power line cycles) is the key to performance tradeoffs in HP's system DMMs. For example, reading rates are maximized by decreasing resolution and the number of power line cycles. Conversely, accuracy and resolution are improved by increasing the number of power line cycles. In short, HP allows you to choose the resolution, accuracy, and noise rejection needed, while maximizing measurement speed.

### High Throughput Reduces Test Time

For system applications, you can increase throughput using DMMs like the HP 3458A. This system DMM is HP's throughput leader when you need to change functions and ranges often to obtain all of your measurements. The ability to change functions and ranges quickly while taking measurements is a good way to view measurement throughput. Several of HP's system DMMs share this common strength to help you improve your throughput and your profits.

Most of HP's system DMMs have a Voltmeter Complete pulse output for incrementing channels on external scanners or switches, without the delay of a computer command. An external trigger input is ideal for synchronizing your DMM to your measurement. Interrupt capability allows your system to run more efficiently, since your computer need only provide control when requested by the DMM. Flexible triggering enables you to properly synchronize measurements with your device-under-test.

Features such as pass/fail limit testing in the HP 3457A and HP 3458A, program memory, and reading storage minimize the computer interaction with the DMM and can help you speed-up your system.

## Specifications

### Inputs

Number of channels: 3  
 Type of input: floating, guarded  
 Sensitivity: 5 mV to 100 V full scale  
 Sensitivity ranges: 41,000  
 Zero offset:  $\pm 2$  full scale or  $\pm 100$  V maximum  
 Zero offset ranges: approximately 5% or range steps  
 Input impedance: 1 M $\Omega$ , shunted by 45 pf (nominal)  
 Maximum input voltage: 200 V dc or peak  
 Maximum source resistance: 10 k $\Omega$   
 Common mode rejection ratio: 140 dB dc; 100 dB ac @ 60 Hz with 1 k $\Omega$  unbalance in LOW terminal and most sensitive range (at 25°C)

### Electrical accuracy (@ 25°C, $\pm 1$ scale offset maximum):

Constant inaccuracy  
 1 V to 100 V range:  $\pm 0.15\%$  of range  
 5 mV to 500 mV range: increases from  $\pm 0.15\%$  of range @ 500 mV to  $\pm 0.26\%$  of range @ 5 mV  
 Reading inaccuracy:  $\pm 0.055\%$  of reading

### Temperature coefficient

Constant inaccuracy  
 1 V to 100 V range:  $\pm 0.012\%$  of range/degree C  
 5 mV to 500 V range: increases from  $\pm 0.012\%$  or range/degree C @ 500 mV to  $\pm 0.044\%$  of range/degree C @ 5 mV  
 Reading inaccuracy:  $\pm 0.01\%$  of reading/degree C

### Timebase

Buffer mode  
 Range: 30 milliseconds to 24 hours  
 Number of ranges: 4,700  
 Direct mode  
 Range: 1 second to 24 hours  
 Number of ranges: 3,700  
 Accuracy:  $\pm 0.1\%$

### Dynamic Performance

Slewing speed (Nominal)  
 Direct mode: 127 cm/s (50 in/s)  
 Plotting mode: 75 cm/s (30 in/s)  
 Acceleration (Nominal): 2 g constant  
 Bandwidth ( $\geq 3$ dB): 3 kHz for all full scale ranges  $\geq 20$  mV  
 2.6 kHz for all full-scale ranges  $< 20$  mV  
 Peak capture: 250  $\mu$ s at fastest timebase range

### Memory per Channel

Size: 1000 words  
 Resolution: 12-bits

### Trigger Characteristics

Internal trigger: Inside or outside window to capture decaying repetitive signals, inside resets with each reverse transition; Above or below level, selectable over the full-scale range in 1.0% of range increments (NOMINAL); Source, channel 1  
 External trigger: BNC connector, TTL level or contact closure to ground  
 Manual trigger: Available from front-panel controls  
 Display: Up to 100% pre-trigger capture, up to 24 hour post-trigger delay before measurement start

## Supplemental Characteristics

**Writing system:** 6-pen carousel with automatic pen capping  
 Fiber-tip pens for paper or transparencies

### Digital plotting

Intelligence: over 40 HP-GL instructions; five built-in character sets including ANSI ASCII, HP 9825, French/German, Scandinavian, Spanish/Latin America Front-panel controls: P1, P2; pen position cursors; pen selection Interface modes (user selectable): listen only; listen/talk

### Media types

Paper, overhead transparency film  
 Sizes (switch-selectable): A4/A (210 x 297 mm, 8.5 x 11 in); A3/B (297 x 420 mm, 11 x 17 in)

### Programming

HP-IB control of all recorder and plotter functions  
 Software lockable front panel

### Scope output

Allows use of X-Y oscilloscope to preview buffer contents  
 Connectors: 2 BNC, vertical and horizontal  
 Output:  $-10$  V to 10 V (0 V corresponds to origin on chart); refreshed every 15 ms  
 Resolution: 10-bit

### Digital voltmeter (DVM) mode

Allows panel display of dc voltage levels on selected channel input Sampling rate: 1/s (NOMINAL)

### Pen position data display

Allows cursor to move pen along Data Display plotted buffer data on selected channel, value shown on display, and coordinate pair can be printed at selected points.

### External pen lift control

BNC connector, TTL level or contact closure to ground

### Analog-to-digital

Max. sampling rate: 33.3 k samples/s  
 Max. streaming rate over HP-IB:

	ASCII	Binary
1 channel	167/s	500/s
1 channel plus trigger	143/s	333/s
3 channels	59/s	167/s
3 channels plus trigger	59/s	167/s

### Real-time clock

Functions: second, minute, hour, day, year  
 Controls: front-panel set, battery (lithium) backup  
 Accuracy:  $\pm 4$  sec/day @ 25°C

### Environmental power requirements

Operating temperature: 0-55°C  
 Source: 100, 120, 220, 240 V ac  $-10\%$ ,  $+5\%$   
 Frequency: 48-66 Hz  
 Consumption: 140 W

### Size

205.5H x 575.0W x 465.0mmD (8.1" x 22.6" x 18.3")

### Weight



Net, 15.7 kg (34.5 lbs); shipping, 23.6 kg (18.3 lbs)

## Accessories Supplied

	Part Number
Interfacing and Programming Manual	07090-90001
Operator's Manual	07090-90002
Pocket Guide	07090-90004

An assortment of pens and media are also shipped with each HP 7090A unit. Paper size and power cord are determined by destination.

## Ordering Information

	Price
HP 10833A HP-IB (IEEE-488) 1-meter cable	\$80 
HP 10833B HP-IB (IEEE-488) 2-meter cable	\$90 
HP 7090A measurement plotting system	\$5500
Option 910 (duplicate set of manuals)	+\$100
HP 17090A/B/C measurement graphics software	
Option 630 (3.5 inch disk size)	\$700
Option 655 (5.25 inch disk size)	\$700

 For same-day shipment, call HP DIRECT at 800-538-8787.

# PLOTTERS & RECORDERS

## Measurement Plotting System

HP 7090A

- Floating and guarded inputs
- dc to 3 kHz bandwidth, 33.3 kHz sampling rate
- 3 channels with simultaneous sampling

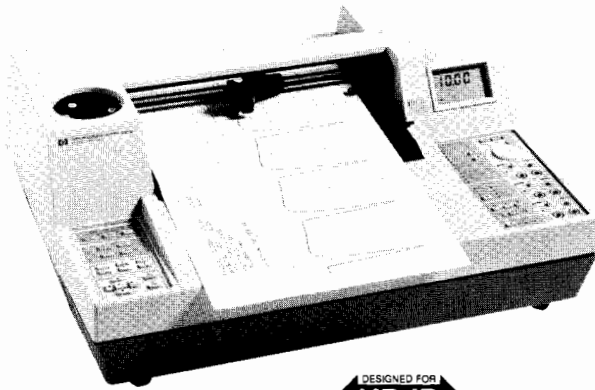

HP 7090A

The HP 7090A is designed for low-frequency (<3 kHz) measurement, analysis, and documentation. It merges several technologies - waveform recording, digital plotting, analog recording, and automated measurement - to provide a powerful solution to a broad range of measurement applications. It significantly increases the ability to measure and display low-frequency phenomena and substantially improves real-time recording and digital plotting, in one low-cost system.

### Signal Capture

Simultaneous sampling on each of three channels, 12-bit resolution, bandwidth of dc to 3 kHz (33.3 k samples/s maximum), and 1000 word memory per channel allow high resolution measurement, storage, and display.

### Flexible Triggering

The HP 7090A has six trigger modes, which allow virtually any signal change to initiate signal capture, even decaying repetitive signals such as faults in a power line voltage, or in a transducer's carrier. Combined with pre-trigger capability, these trigger modes make the HP 7090A Measurement Plotting System ideal for turn-on/off characterization, fault monitoring and mechanical motion analysis.

### A System Component

All panel functions are programmable via the HP-IB interface. Data can be transferred from the internal 1 k-buffers or streamed in real time from the analog-to-digital converters at up to 500 points/s. In addition, the menu-driven HP 17090 measurement graphics software package is available for properly configured HP 9000 Series 200 and 300 computers (BASIC only). The software allows easy data manipulation, storage and retrieval, and system integration.

### Versatile Capabilities

As the name implies, the HP 7090A measurement plotting system is also a high-performance digital plotter. It is ideal for a graphics dump from a smart instrument (e.g., from an HP spectrum analyzer) or as part of an HP-IB system; you can also use the HP 7090A to take an X-Y dump from an analog instrument (e.g. from an HP spectrum analyzer system). With the HP 7090A, hand annotation is unnecessary. The 7090A annotates setup conditions, date and time, selected data points from memory, and trigger information. It draws user-defined axes and grids, eliminating the need for pre-printed graph paper. The HP 7090A even lets you plot overhead transparencies for technical presentations.

- 12-bit resolution, 1 k buffer/channel
- 6 trigger modes with up to 100% pre-trigger capture
- Full programmability and data transfer over HP-IB

### Applications

**Analog recording:** Electrical, chemical, mechanical and medical fields all benefit from recording real-time X-Y and Y-T relationships. As an analog recorder, the HP 7090A has sensitivity to 5 mV full scale and 41,000 calibrated ranges for easy and quick calibration to measurement units. The HP 7090A's superior dynamic performance and high sensitivity provide users the versatility and accuracy required in laboratory environments.

**Capturing low frequency electrical transients:** General diagnostic monitoring (such as looking for relative timing sequences) and fault monitoring (capturing pre-trigger data for intermittent failure analysis) are natural applications for the HP 7090A.

**Measuring phase relationships:** The simultaneous sampling on all channels is ideal for measuring current/voltage phase relationships in power systems.

**Analog instrument/digital system link:** The HP 7090A can integrate an analog instrument into an HP-IB system; the HP 7090A, with a controller can digitize output voltages from analog instruments for HP-IB system data entry.

**Mechanical and electromechanical testing:** Applications in which transducers convert velocity, acceleration, force, temperature or torque to voltage are a good fit for the HP 7090A. These applications have a maximum output frequency below 3 kHz. The HP 7090A's flexible trigger capabilities make it useful for one-shot electromechanical events such as clutch and mechanism engagements.

**Electromechanical control systems:** The HP 7090A can measure the response of a system to a stimulus; a typical use would be exciting the system with a step function and using the measured response to determine damping ratio and the natural frequency of the control system.

**Material testing:** The HP 7090A can record classic stress-strain curves, particularly those obtained from destructive testing. The data is stored in a buffer, so even though the sample has been destroyed, the data can be viewed and rescaled in several different ways.

**Automatic test:** When linked to an HP 9000 Series 200 computer, the HP 7090A is a good, inexpensive learning tool for small companies considering automatic test systems. Applications include environmental and production line testing and proof of performance records.

### Measurement Graphics Software

HP 17090 measurement graphics software is designed to access the full capabilities of the HP 7090A Measurement Plotting System and integrate it into computer system applications. This software is compatible with properly configured Series 200 and Series 300 computers. The computer system must have ten softkeys, a knob, and separate displays for alpha characters and graphics. The main user interface with this software is through 10 softkeys on the computer's keyboard and a knob.

**Program capabilities:** There are six main functional areas of Measurement Graphics Software:

- measurement setup
- measurement
- display
- annotation
- storage and retrieval
- data manipulation

Measurement Graphics Software helps you use the HP 7090A's features easily and efficiently, and it provides storage, annotation and data transformation capabilities not available on the HP 7090A unit alone.

**Friendly, menu-driven interface:** Each menu allows the user to view several parameters simultaneously. Series 200 and 300 softkeys and cursor-control knob minimize keyboard input, and the "help" softkey displays the available choices and ranges for each parameter setting.

- Save time storing and recalling waveforms
- Quickly modify and utilize waveforms
- Save time when generating arbitrary waveforms
- No programming necessary

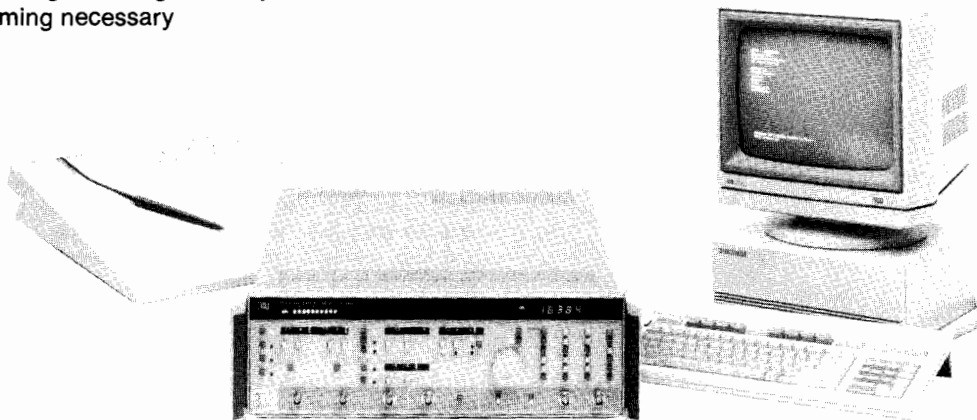

HP 5182S



This signal was recorded from a floppy disk read head.

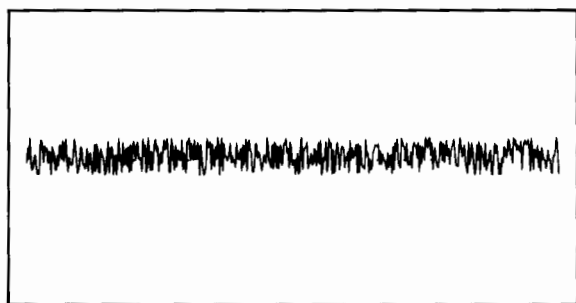

The signal is combined with noise generated from built-in function.

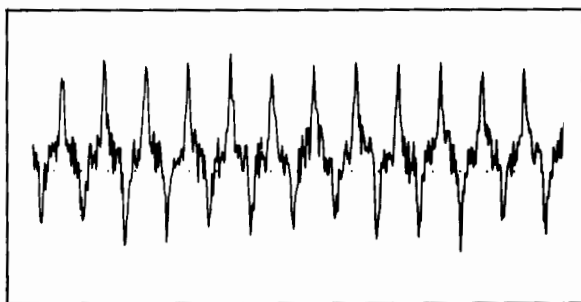

It is used to test the sensitivity of read recovery circuits.

## HP 5182A, 5182S Waveform Generation

### Save Time Generating Specialized Waveforms

The HP 51820A software is a powerful set of tools for creating specialized waveforms. Modify captured waveforms or define new ones with the HP 46087A graphics tablet (part of the HP 5182S system). Simply press a SOFTKEY to send waveforms to the HP 5182A for replay or disc for storage. Since the HP 51820A is a complete package (no programming is required), you are productive immediately.

The software is driven by a main menu and three submenus: draw, process and I/O. Because it is only two levels deep, you will not get lost in multiple levels of menus.

### Waveform Capture, Modification and Playback

Modify captured waveforms and play them back into the device you are testing. Rather than waiting for a glitch to occur randomly, you can draw one and see the circuit response immediately.

Waveforms can also be modified by processing. Simple functions like offset and gain are built into the SOFTKEY MENU. There are also SOFTKEYS for adding or multiplying two waveforms together.

More complicated processing like calculus and convolution can be accomplished by modifying the user-equation subroutines. Four SOFTKEYS are reserved for your own equations. The software comes with the equations programmed to generate sine waves, triangle waves, square waves and random noise.

### Arbitrary Waveform Generation

There are three ways to create the waveforms you need. You can recall waveforms from the library, including sine waves, square waves,  $\text{SIN}(X)/X$ , Gaussian pulses, exponentials and more. You can calculate waveform samples with equations. Third, you can draw or trace waveforms with the graphics tablet. Choose the method that will get you the signal you need in the shortest time.

### Ordering Information

HP 5182S waveform generation system

Price

\$0

HP 51820A waveform generation software

\$1,525

To ensure coordination of shipments and compatibility of instruments, computers and software, use the system model number when ordering individual components including peripherals such as printers and plotters. Obtain HP 51820A and HP 51800A data sheets and a HP 5182S ordering guide from your local sales office. See page 737.

# OSCILLOSCOPES & WAVEFORM ANALYZERS

## Waveform Recorder/Generator, 20 MHz, 10 Bits, 16K Word Memory

### HP 5182A

- 16K nonvolatile waveform memory
- Fully programmable via HP-IB
- Quickly transfer waveforms to/from computer

- Easily simulate complex, real signals
- Record single-shot, replay repetitively

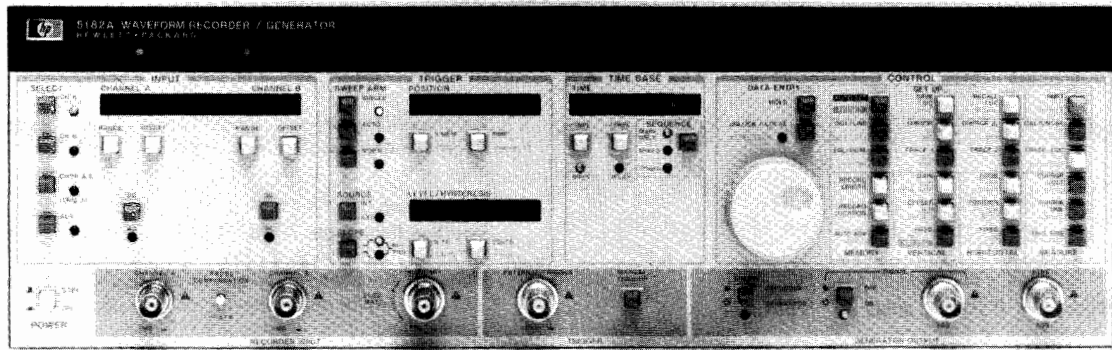

### Duplicate Infrequent Waveforms When You Need Them

Recreate your single-shot signals with HP 5182A waveform recorder/generator. Also create repetitive signals by playing back a single recording again and again with no time gap between replays.

Now you can test your circuits with the actual signal you record rather than a theoretical one. "What if" testing can be done by adding a computer to modify and store the waveforms. An HP Series 200/300 technical computer, HP 9111A graphics tablet and an HP 5182A comprise the HP 5182S waveform generation system.

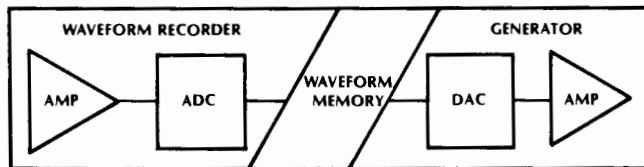

### A Waveform Recorder/Generator is a High-Speed Digital "Tape" Recorder

The "tape" is silicon memory. At 20 M samples per second, it can store 819  $\mu$ s, 819 seconds at 20 samples per second. This digitized waveform can be played back once, or over and over again with no time gap. For example, you can accurately store 16 separate lines of video, or a single sector of data from a floppy disk drive. The video signal can generate color bar patterns to test video circuits. The disk signal can be used to test read-recovery circuits.

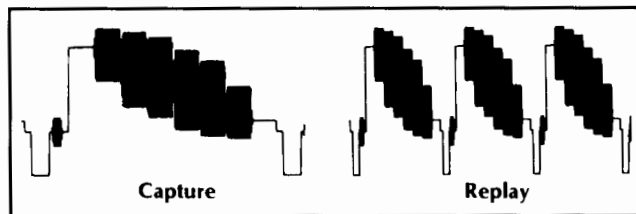

### Capture and Save in the Field, Replay on the Bench

Continuous (battery backed up) waveform memory allows you to record up to 32 waveforms on site. Remove the power and carry the HP 5182A back to the lab. Now you can play them back to test your circuits or for further analysis. Attach the HP 5182A to an HP Series 200/300 technical computer and you can store the waveforms on disk, process them further and modify them for "what if" testing.

### Simulate Expensive, Single-Shot Experiments

Some experiments can be very time-consuming and expensive to repeat, for example, biomedical experiments, measurements of explosions, and propagation experiments such as radar and sonar. With the

HP 5182A you can capture a signal accurately when it occurs, then switch to generator mode, to replay it any time you need it.

A sync pulse is generated once per playback cycle for synchronizing other equipment.

### Generator Section Specifications

#### Peak output voltage (for full-scale waveform) into 50 ohms

Range	Vernier Range Min	Max	Vernier Step Size
5.12 V	520 mV	5.12 V	40 mV
512 mV	52 mV	512 mV	4 mV
51.2 mV	5.2 mV	51.2 mV	0.4 mV

**Max. output voltage into open circuit:** 10 V (NOMINAL).

**Output offset:** -5.12 V to +5.11 V in 10 mV steps into 50 ohms.

**AC performance:** Noise: -65 dBc.

**Harmonic distortion (dc to 1 MHz):** -48 dBc.

**Spurious (sample rate related):** -40 dBc TYPICAL.

**Output risetime:** 100 ns max. (10% to 90%).

**Amplifier bandwidth (-3dB):** 10 MHz (NOMINAL)

**DC performance (10 bits resolution per sample)**

**Differential nonlinearity:** <1 LSB (Monotonic).

**Integral nonlinearity:** <3 LSB.

**Offset accuracy:** 100 mV (20-30°C).

**Absolute accuracy:** 1% of p-p full scale range (20-30°C).

**Internal trigger:** Output automatically triggered when armed.

**External trigger:** Slope, level, hysteresis, width, impedance, coupling and maximum input same as for Recorder. (See page 78.).

**Insertion delay:** 250 ns max.

#### Time base modes

**Main only:** Available in Single, Auto, and Normal Sweep Arm modes.

**Mixed (main, delay):** Available in Single and Normal Sweep Arm modes.

**Memory size:** 16384 10-bit words; Segmentation: 1,2,4,8,16 or 32 equal length blocks. Generation: Data may be generated from any memory block. Within any one block, a portion of the waveform may be generated by setting the starting point and stopping point. An even number of points is always output.

**Sync output:** Voltage: 0 to -0.75 V NOMINAL into 50 ohms, Pulse Width: One sample interval with the falling (first) edge active (or approximately 100  $\mu$ s when the sync pulse is past the stop position, and Sweep Arm is Single or Normal). Position: Settable from first point in the record to the last point. If the sync position is set outside the limits of the Start and Stop Position markers, the output record is extended to include the Sync Position by assigning a dc voltage (equal to the nearest Start/Stop Position marker) to the waveform between the Start/Stop Position marker and the sync position.

### Ordering Information

HP 5182A waveform recorder/generator

### Price

\$31,700

# OSCILLOSCOPES & WAVEFORM ANALYZERS

## Waveform Recorder/Measurement System

HP 5180A, 5180S, 51800A

79

- 16K memory records up to 32 waveforms
- Accurately digitizes transient signals
- Up to 1 million words/s data transfer

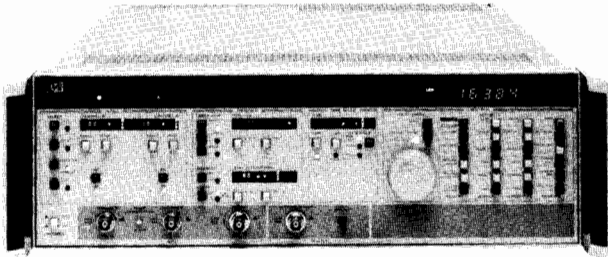

HP 5180A



### HP 5180A, HP 5180A, and HP 51800A

#### High Quality Samples Every 50 Nanoseconds

The HP 5180A waveform recorder digitizes and stores single-shot or repetitive signals. Voltage waveforms are digitized at sampling rates up to 20 M sa/s (50 ns/sample). Each voltage sample is encoded into a 10-bit word and stored into the memory. These precise voltages (and times) can be read from the front panel with cursors.

**Accurately Digitize Transients** - The shape of fast attack and decay single-shot waveforms is preserved because the higher frequency components are accurately digitized. (See HP Product Note 5180-2.)

#### View Single-shot or Repetitive Signals Quickly

The HP 5180A controls external XYZ displays and hardcopy devices to show the contents of memory records without the need for a computer. Zoom and Gain features expand displayed waveforms horizontally or vertically to look in detail at a selected portion of a waveform. There are two methods of transferring data from the HP 5180A to a computer for analysis: HP-IB and DMA. Direct memory access (DMA) can transfer data at a rate up to 1 million words/second, depending on the computer.

The HP 5180A can begin recording a signal at one sampling rate and then switch to another. The switch point is selectable. Set one timebase at a faster sample rate to record more detail, and set the other at a slower rate to conserve memory space.

#### Automatic Time Domain Measurements

Make time domain measurements on single-shot or repetitive waveforms with the HP 51800A Waveform Measurement Library. The library is a collection of programs designed to make measurements on signals captured by the HP 5180A Waveform Recorder and HP 5182A waveform recorder/generator. Instruments are controlled by sub-programs. All you do is chain them together to make the measurements you need.

#### HP 5180A Specifications

See HP 5180A Waveform Recorder data sheet (Pub 5952-7722D) for more information.

#### Channel A and B Inputs

**Maximum sensitivity:** 200  $\mu$ V.

**Input attenuator range:**  $\pm$ 100 mV to  $\pm$ 10 V (full scale).

**Input offset voltage:**  $\pm$  selected Voltage Range.

**Amplifier bandwidth (-3 dB):** dc to 40 MHz (dc coupling).

10 Hz to 40 MHz (ac coupling).

**Input impedance (nominal):** 1 M $\Omega$  || 40 pF (10 V range).

1 M $\Omega$  || 35 pF (other ranges).

**Damage level:**  $\pm$ 12 V above 1 kHz.

#### Dynamic Performance (at 1 MHz)

**Harmonic and spurious distortion:** -50 dBc

**Effective bits:** 7.8

#### Triggering

**Internal trigger:** level and sensitivity selectable over input voltage range.

**External trigger:** level selectable over  $\pm$ 2.5 V range.

**Trigger position:** -100% to +9999% of memory.

#### Timebase

**Internal timebase:** 20 MHz internal timebase allows sample rates between 50 ns and 50 ms in a 1-2-5 sequence.

**External timebase:** external timebase signals between 1 MHz and 20 MHz may be used. Internal divide ratio between 1 and  $10^6$  in a 1, 2, 5 sequence.

#### Memory

**Size:** 16,384 10-bit words.

**Segmentation:** memory may be divided into 1, 2, 4, 8, 16, or 32 equal-length records.

#### Outputs

**XYZ CRT monitor outputs:** X, Y deflection voltages (NOMINAL) -1 to 0V into 50  $\Omega$ . X requires 1 MHz bandwidth input; Y requires 5 MHz bandwidth input. Z voltage (NOMINAL) is 0 to 2 V into 1 k $\Omega$  (0 to 1V into 50  $\Omega$ ), selectable positive or negative going blanking pulse. Z requires 1.25 MHz bandwidth input.

**HP-IB:** all front panel function values selectable via HP-IB. Data I/O in ASCII or binary; maximum 3 Kbyte/second rate, depending on controller. "Talk only" to HP-GL plotters available even if no controller is used.

**DMA:** direct memory access allows fast parallel data transfer; maximum 1M word/second, depending on controller.

#### General

**Operating temperature:** 0°C to 55°C.

**Power requirements:** 100/120/220/240 volts +5%, -10%; 48 to 66 Hz. Max power dissipation 500 VA.

**Weight:** net, 22 kg (48 lb); shipping, 25 kg (53 lb).

**Size:** 142 H x 426 W x 574 mm D (5 $\frac{5}{8}$ " x 16 $\frac{3}{4}$ " x 23").

#### Ordering Information

HP 5180A waveform recorder

**Price**

\$27,200

HP 5180S waveform measurement system

\$0

To ensure coordination of shipments and compatibility of instruments, computers and software, use the system model number when ordering the individual components, including peripherals such as printers and plotters. Obtain an HP 51800A data sheet and HP 5180S ordering guide from your local sales office. See page 737.

HP 51800A Waveform Measurement Library

\$1,525

Opt 910 Additional Manuals

+\$150

#### Accessories for HP 5180A

HP 10871B service kit

\$6,350

HP 10873A Rackmount kit

\$210

HP 10874A Slide mount kit

\$265

HP 10875A 4.8 m DMA cable

\$255

HP 10875B 1.0 m DMA cable

\$255

To ensure coordination of shipments and compatibility of instruments and peripherals such as printers, plotters, and disk drives, it is important that you request the appropriate data sheets and ordering guides from your local sales office.



# OSCILLOSCOPES & WAVEFORM ANALYZERS

## Waveform Recorder

HP 5183A

- 72 dB of dynamic range for analysis
- New high measurement throughput BASIC driver software
- Systems of up to 64 channels
- Adaptive sample rate
- 256K words per channel optional memory
- Differential input

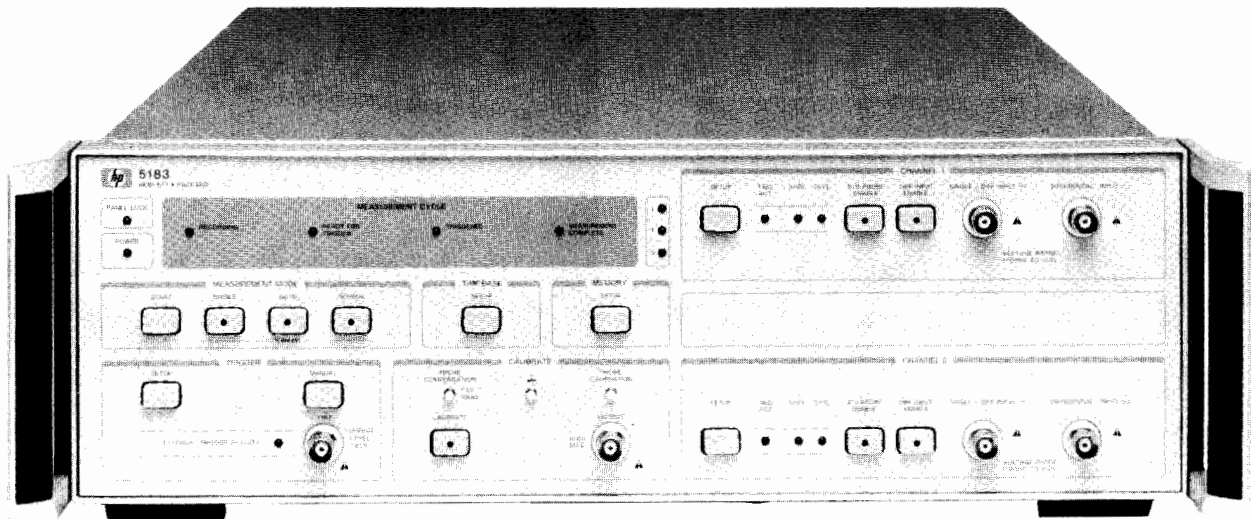

HP 5183A

### HP 5183A Waveform Recorder High Throughput for Automated Measurements

The HP 5183A is not a stand-alone instrument; it functions as a digitizing front end to a computer. HP BASIC driver software, optimized for speed, helps to set up, take measurements, and transfer data at high speeds to an HP 9000 Series 200/300 workstation or HP Vectra PC. The HP 5183A's auto-advance feature can yield up to 70 measurements (1K words) per second with re-arm time as short as 13 ms. Trigger features allow data acquisition that was previously either impossible, or required complex external trigger circuitry. The optional 512K word memory allows long continuous records to be acquired. In one channel operation, channel one can be configured to have 512K samples with option 512 installed. Adaptive Sample Rate gives the benefit of catching glitches that would ordinarily escape detection.

#### Enhanced trigger capability

As with the other Hewlett-Packard waveform recorders, post- and pre-triggering are available. This permits viewing of the trigger point, the events leading up to the trigger point, or events that occur long after the trigger has occurred. Dropout trigger provides the capability to trigger on the absence of a signal. The recorder can be configured with auto advance to capture up to 256 1K records showing dropouts, when Option 512 is installed.

Delay trigger is used in the following manner. A trigger event occurs at the external trigger input. Then, when a user defined delay elapses, the recorder will wait for the proper internal trigger and record in the operator defined environment. This can be used for recording signals such as a specific sector on a magnetic disk, using the index pulse as the external trigger, and the approximate delay to the proper sector.

#### ASR (Adaptive Sample Rate - Option 301)

ASR provides rapid sampling only when it is needed, conserving memory where possible. With this option, the recorder samples at a slow speed until high-frequency energy is detected. When this occurs, the timebase switches to a higher speed to capture the high-frequency signal, returning to the slower speed when the high-frequency component ceases. For some signals, particularly those with low duty cycles, the maximum effective memory length can be increased (by a factor approaching 64) to approximately 30 million words.

### HP 5183A Condensed Specifications\*

#### Channel 1 and 2 inputs

**Maximum sensitivity (nominal):** 50  $\mu$ V.

**Input attenuator ranges:**  $\pm$  100 mV to  $\pm$  50 V (full scale).

**Input offset voltage:**  $\pm$  200% of input attenuator range.

**Input bandwidth (nominal):** (-1 dB) 1 MHz, (-2 dB) 3 MHz with filter (10 pole), (-4 dB) 1 MHz, (-65 dB) 3 MHz.

**Input impedance (nominal):** 1M $\Omega$  in parallel with 45 pF.

**CMRR at 10 kHz:** 60 dB on 100 mV to 1 V ranges.

**Damage level:**  $\pm$  5 V (dc plus peak ac) on 100 mV to 1 V ranges. 400% of range (dc plus peak ac) on 2 V to 50 V ranges.

#### Dynamic Performance at 1 MHz Signal Input after Calibration

**Harmonic and spurious distortion:**  $\leq$  65 dBc.

**Effective bits:** 10.0 at 95% of full scale range.

#### Triggering Characteristics

**Internal trigger:** level and sensitivity selectable over input voltage range.

**External trigger:** level selectable over  $\pm$  5V range, in mV increments.

**Internal source:** Channel 1, Channel 2.

**Measurement control:** auto, normal, single, manual trigger.

**Settable:** level, hysteresis, position.

**Slope:** +, -, or bi-trigger (internal only).

**Trigger position:** -100% to +6400% of record length.

#### Time Base

**Internal time base:** 4 MHz internal time base allows sample rates between 250 ns and 4 s, in 250 ns increments.

**External time base:** 1, 4 or 10 MHz.

**External encode:** 1  $\mu$ Hz to 2.1 MHz or 1.9 MHz to 4 MHz.

#### Memory

64K words per channel standard; with option 512, 256K words per channel, also configurable as a single 512K word record for channel 1.

#### Ordering Information

HP 5183A waveform recorder 2-channel (includes an interconnect cable and software for control and data transfer on the HP 200 and 300 series computers).  
Requires host computer for operation.

Opt 301 adaptive sample rate

Opt 512 512K word memory

**Price**

\$14,500

+\$3,450

+\$5,750

\*See HP 5183A Recorder Data Sheet (Pub 5952-7933D) for more information.

- Clamped or unclamped video output.
- Trigger output for line and frame.
- For most standard broadcast composite video systems
- Compatible with most analog & digitizing scopes

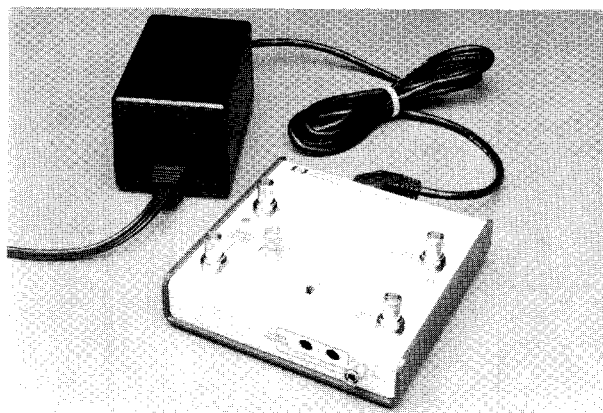

**HP 1133A TV/Video Sync Pod**

The HP 1133A TV/video sync pod is an accessory that provides users with TV sync triggering for most analog or digitizing oscilloscopes. It features clamped or unclamped video outputs that can be viewed on the oscilloscope's vertical channels and trigger outputs that can synchronize the oscilloscope to video frame and individual lines.

The pod itself is packaged in a case approximately 14x14x4.5 cm (5.5x5.5x1.75") and is powered by a separate ac power module. The pod features a loop-thru input (two female BNC) which can be driven from a 75 ohm source, or for probing high impedance circuits, from a 1-10 megohm probe. The loop-thru feature allows 75 ohm signal to be looped through the TV/video pod then connected to a video monitor or other 75 ohm device. Clamped or unclamped video outputs are designed to drive a high impedance probe (1-10 megohm) connected to the oscilloscope input.

The HP 1133A is compatible with broadcast standards M, N, C, B, G, H, I, D, K, K1, and L systems.

**Characteristics**

Video input: ac coupled with an RC of 1 megohm shunted by approximately 10 pF.

Bandwidth: Approximately 10 MHz

Maximum input voltage: 40 Volts (dc plus peak ac)

Frame output is phase locked to the leading edge of the third field synchronizing pulse on field one, to the leading edge of the second pulse on field two. Frame output goes high on field one, and low on field two.

There is a switch for positive or negative sync pulse polarity.

A gain control adjusts for signal amplitude at BNC input.

Gain from input BNC to unclamped output is approximately 2.5 to 50.

**Ordering Information**

Note: The 1133A must be ordered with a power supply option.

HP 1133A TV/Video Sync Pod	\$275
Opt ABA Power supply for U.S.A., 120V, nema 515P plug	\$0
Opt ABB Power supply for Europe, 220V CEE7-VII plug	\$0
Opt ABJ Power supply for Japan, 100V nema 515P plug	\$0
Opt ABU Power supply for United Kingdom, 240V BS1363 plug	\$0

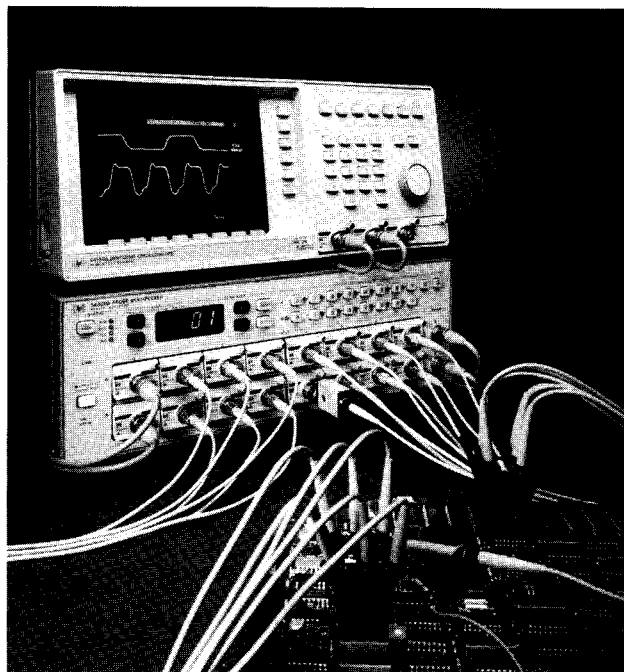

**HP 54300A PROBE MULTIPLEXER**

**Multi-input Tool For 50Ω Instrumentation**

The HP 54300A is a programmable, dual eight-to-one probe multiplexer designed to expand the input capability of instrumentation with 50Ω inputs. The unique strength of this multiplexer is its configurability. The user may select from three different input pods: two high-frequency, high-impedance probes, or a 50Ω BNC input for terminated line applications.

The HP 54300A features full HP-IB programmability as well as simple front-panel control. It has internal non-volatile memory for storing lists of switching steps. Switch lists can be advanced step-by-step from a front-panel button, over the HP-IB (i.e., IEEE-488) or for data logging applications, through a TTL pulse entered at the rear panel.

**HP 54001A 1 GHz Active Mini-probe Pod**

This pod, with its built-in probe, offers 1 GHz bandwidth with 10kΩ/2 pF input loading. It uses HP's mini-tip probe for easy access in compact circuits, and features both high-bandwidth and high-impedance at the probe tip.

**HP 54002A 50Ω BNC Pod**

This pod should be used with terminated 50Ω systems. Output from the multiplexer using this pod is <2 dB down at >1 GHz. The 54002A is also useful with divider probes such as the HP 10020A.

**HP 54003A 300 MHz 1 MΩ Probe Pod**

This pod, with a 10:1 detachable mini-tip probe, has 1 MΩ resistive and 8 pF capacitive loading. It is valuable when resistance is a more significant loading factor than capacitance, such as in operational amplifier measurements. If desired, the probe can be removed from its pod to provide a 1 MΩ approximately 10 pF BNC input.

**Ordering Information**

HP 54300A dual 8:1 probe multiplexer	\$8500
Includes one operating and programming manual. Each HP 54300 accepts up to 16 input pods in any combination. Pods must be ordered separately.	
Opt 908 Rackmount flange kit	+\$35
HP 54001A 1 GHz miniature active probe pod	\$765
HP 54002A 50Ω BNC input pod	\$130
HP 54003A 1MΩ 10:1 probe pod	\$665

# OSCILLOSCOPES & WAVEFORM ANALYZERS

## Oscilloscope Probes And Accessories (cont'd)

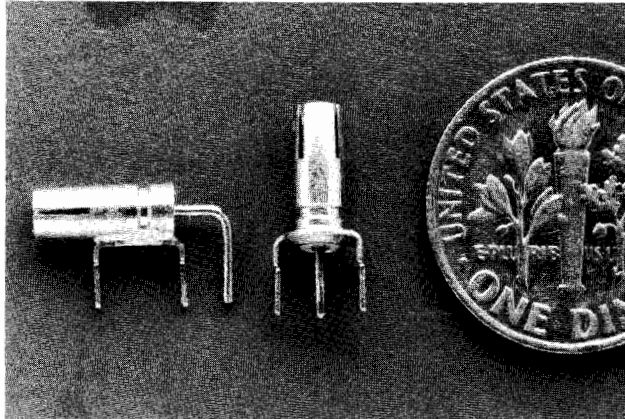

### HP 1250-1737 PC Board Mini Probe Socket

The HP 1250-1737 PC board mini probe socket is ideal for breadboard circuit applications where it is desirable to make a reliable circuit connection between the mini probe tip and a test circuit (Soldering the tip itself into place is not recommended.) The HP 1250-1737 is also useful in production PC board applications as an oscilloscope test point. The probe plugs into the socket parallel to the PC board.

### HP 1250-1918 PC Board Vertical Mini Probe Socket

The HP 1250-1918 is similar to the 1250-1737 (above) except that it is designed for attaching the probe vertically to the board rather than horizontally.

### HP 10024A/10211A IC Test Clip

The HP 10024A IC test clip provides easy probing of 14- and 16-pin dual in-line packages and includes four insulated circuit interface pins. Additional circuit interface pins are available (see Ordering Information) in packages of twelve pins. Each pin has a tip on each end so that probes such as those on HP logic analyzers can be connected for fast, functional checks of circuit operation.

The HP 10211A dip clip is similar in operation to the HP 10024A, but accesses 24-pin dual in-line package IC.

## Probe Accessories

### Terminations

HP 10100C: 50 ohm  $\pm 1\%$  BNC male to BNC female feedthrough termination.

### Standard Probe Tip Adapters

HP 10229A hook tip adapter: retractable pincer tip provides firm connection to circuit nodes. Recommended accessory for HP 10020A resistive divider kit.

### Ordering Information

	Price
HP 1250-1737 PC board mini probe socket	\$6.75
HP 1250-1918 PC board mini probe socket (vertical)	\$8.25
HP 10024A IC test clip (with 4 circuit interface pins)	\$20.00
HP 10024-69501 interface pin kit for HP 10024A; includes 12 interface pins.	\$55.00
HP 1250-1454 BNC-to-mini probe adapter	\$15.00
HP 10211A dip clip	\$81.00
HP 10229A retractable hook tip adapter	\$20.00
HP 10100C 50 ohm feedthrough termination	\$40.00

### Transportation Accessories

The following transportation accessories are available for the HP 54500 series and HP 16500 series.

HP 1540-1066 soft carrying case	\$135
HP 9211-2645 transit case	\$430
HP 5061-6183 front-panel cover	\$35

## Testmobiles

The low-priced HP 1180A testmobile cart is designed for HP 54500, HP 54200 digitizing oscilloscopes, and HP 1630, HP 1650 logic analyzers. A quick-connect strap enables users to easily remove or replace the scope on the cart. The large casters give excellent stability and smooth maneuverability. The top shelf tilt angle is adjustable to optimize the oscilloscope's viewing angle. The back of the cart has power cord storage and mounting provisions for a five-outlet U.S. power strip (not included, order part number HP 92199B). For larger, heavier instruments, use the HP 1008A (see specifications below).

### Testmobile Specifications

	HP 1008A	HP 1180A
Height	930 mm (36.6 in)	890 mm (35.0 in)
Overall width	759 mm (29.8 in)	475 mm (18.7 in)
Width of tray	473 mm (18.6 in)	456 mm (18.0 in)
Tilt tray angle	$\pm 30^\circ$	+30°
Max load on tilt tray	45 kg (100 lb)	20.5 kg (45 lb)
Max load below tilt tray	see option 006 description	25 kg (55 lb)
Weight	net	13 kg (28 lb)
	shipping	22 kg (48 lb)
		30 kg (66 lb)

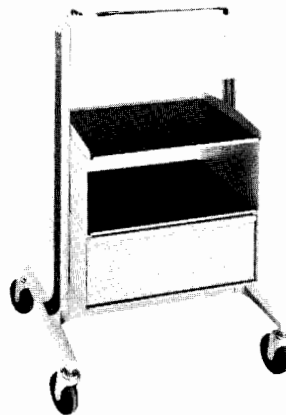

HP 1008A with Opt 006: storage cabinet with shelf on top and drawer in lower position; load limit 18 (40 lb) each on shelf and in cabinet, 11 kg (25 lb) in drawer.

### Ordering Information

HP 1180A testmobile

HP 1008A testmobile

Opt 006 Added shelf and cabinet for 1008A

HP 92199B U.S. power strip for HP 1180A

☎ For same-day shipment, call HP DIRECT at 800-538-8787.

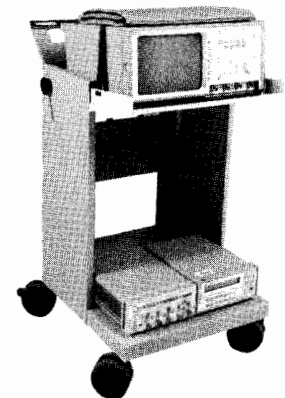

HP 1180A: Low-priced testmobile for the HP 54500, HP 54200, HP 1630, and HP 1650 series.

\$290 ☎

\$970

\$270

\$36 ☎



- dc to 200 MHz probe bandwidth
- $\pm 200$  V (dc + peak ac) maximum voltage without attenuators
- 2000:1 CMRR at 1 MHz

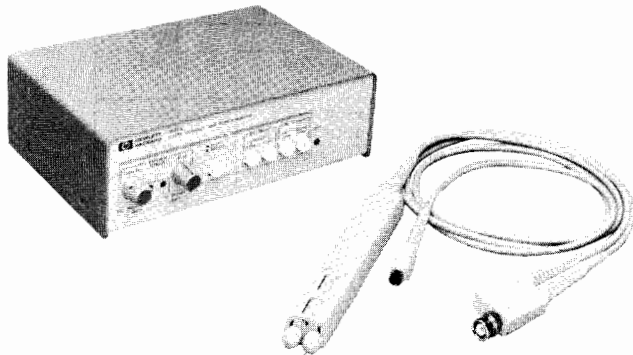

HP 1141A, 1142A

- 10X, 100X attenuators
- dc offset & dc reject
- Remote-control input coupling and offset

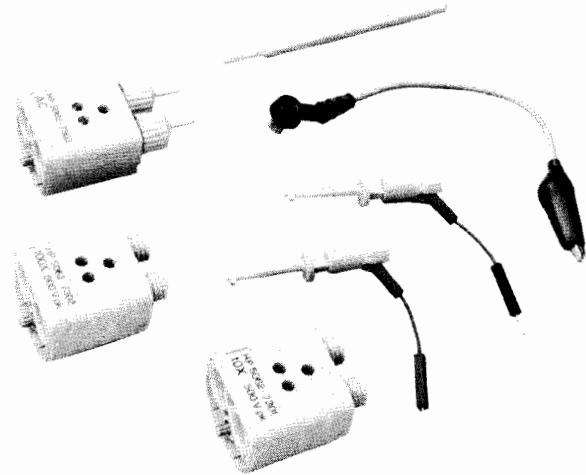

HP 1141A Accessories

### HP 1141A Differential Probe

The HP 1141A is a 1X FET differential probe with 200 MHz bandwidth and 2000:1 CMRR (Common Mode Rejection Ratio). The probe has a high-input resistance of 1 M $\Omega$ , and low-input capacitance of 7 pF to minimize circuit loading.

The HP 1142A probe control and power module, which controls input coupling modes (dc and dc rejects) and which can be connected to any instrument with 50  $\Omega$  inputs. The offset capability in the HP 1142A allows the viewing of very small signals on large dc components without attenuating low ac frequency components or causing sag from ac couplings. In automated test applications, the offset level can be changed with an external dc reference.

Two attenuators, 10X and 100X, are provided to expand the dynamic range of the inputs to  $\pm 35$  V. An ac adapter is also provided.

#### Operating Characteristics

**Bandwidth:** dc to 200 MHz ( $-3$  dB)

**Rise time:** 1.75 ns (calculated by  $t_r = \frac{0.35}{\text{bandwidth}}$ )

**CMRR:** 2000:1 @ 1 MHz; 10:1 @ 100 MHz

**Vertical accuracy:** 1.5 % (1X), 3.0 % (atten)

**Dynamic range:** dc-50 MHz:  $\pm 0.35$  V (1X),  $\pm 3.5$  V (100X), 50-200 MHz:  $\pm 0.17$  V (1X),  $\pm 1.7$  V (10X),  $\pm 17$  V (100X)

**dc offset:**  $\pm 20$  V (1X),  $\pm 200$  V (10X),  $\pm 500$  V (100X)

**Common mode input:**  $\pm 0.5$  V (1X),  $\pm 5$  V (10X),  $\pm 50$  V (100X)

**Maximum input voltage:** 200 V dc + peak ac (1X), 500 V dc + peak ac (atten)

**Noise:** 500  $\mu$ V rms

**Input coupling:** dc, dc reject and ac (dc and dc reject are selected by pushing buttons on the 1142A; ac coupling is provided via an adapter that attaches to the probe tip).

**ac coupling low frequency response:** 15 Hz (1X), 1.5 Hz (atten), 1.3 Hz (100X)

**Input RC:** 1 M $\Omega$  shunted by approximately 7 pF (1X)

**Output impedance:** 50  $\Omega$

#### General

**Power requirement:** 90-132 Vac/198-264 Vac, 47-440 Hz, 25 VA max

#### Temperature:

non-operating:  $-40$  to  $70^\circ$  C

operating:  $0$  to  $55^\circ$  C

#### Altitude:

non-operating: up to 50,000 ft (15,300 m)

operating: up to 15,000 ft (4,600 m)

#### Humidity:

non-operating: 90% relative @  $65^\circ$  C

operating: 95% relative @  $40^\circ$  C

**Cable length:** 4.5 ft (1.3 m)

#### Ordering Information

HP 1141A differential probe

**Price**  
not to exceed \$2500

Includes: HP 1142A probe control and power module, 10X and 100X voltage attenuators, ac coupler, five probe leads, two probe clips, operating & service manual, calibration adapter, and ground lead.

# OSCILLOSCOPES & WAVEFORM ANALYZERS

## Oscilloscope Probes and Accessories (cont'd)

### HP 1124A Specifications

(Measured when connected to a 50  $\Omega$  load)

**Bandwidth:** (measured from a terminated 50  $\Omega$  source) dc-coupled, dc to 100 MHz; ac-coupled, 2 Hz to 100 MHz.

**Pulse response:** (measured from a terminated 50  $\Omega$  source) transition time, <3.5 ns; perturbations, 5% p-p. Measured with pulse transition time of >2.5 ns.

**Attenuation ratio:** 10:1  $\pm$ 5%; 100:1  $\pm$ 5%.

**Dynamic range:** x10,  $\pm$ 10 V; x100,  $\pm$ 100 V.

**Input RC:** 10 Mohm shunted by  $\approx$  10 pF.

#### Maximum safe input

dc-coupled: x10,  $\pm$ 300 V (dc + peak ac)  $\leq$ 100 MHz; x100,  $\pm$ 500 V (dc + peak ac)  $\leq$ 100 MHz.

ac-coupled: x10,  $\pm$ 300 V (dc + peak ac)  $\leq$ 100 MHz; dc component must not exceed  $\pm$ 200 V; x100,  $\pm$ 500 V (dc + peak ac)  $\leq$ 100 MHz; dc component must not exceed  $\pm$ 200 V.

**Accessories supplied:** one 20.3 cm (8 in) ground lead, one retractable hook tip, and two probe tip insulating caps.

**Power:** supplied by instruments with probe power jacks or the HP 1122A probe power supply.

**Weight:** net, 0.2 kg (5 oz); shipping, 0.91 kg (2 lb).

**Length:** 1.5 m (5 ft) overall.

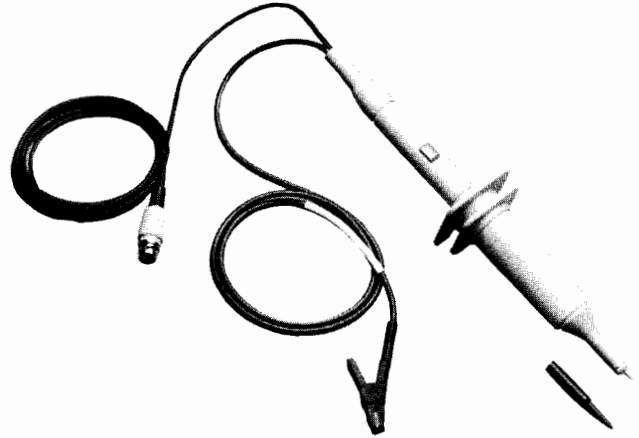

### HP 1137A High-voltage Divider Probe

The HP 1137A 1000:1 high-voltage divider probe is designed for use with any oscilloscope having input resistance of 1 M $\Omega$  ( $\pm$ 1%) and nominal input capacitance between 6 and 50 pF. The HP 1137A is a 1000:1 voltage divider probe that extends voltage measurement capability to 5 kV ac or dc.

#### Operating Characteristics

##### Maximum input voltage

dc voltage 5 kV

ac voltage 5 kV rms (0 to 250 kHz), 2.5 kV rms, (250 kHz to 1 MHz).

**Input impedance:** 500 M $\Omega$  shunted by 3 pF (approximate)

**Bandwidth:** 1 MHz

**Rise time:** Approximately 350 ns

Calculated from formula:  $t_r = \frac{0.35}{\text{bandwidth}}$

**Temperature coefficient:**  $\pm$  0.02% of reading per degree C.

**Division ratio accuracy:**  $\pm$  1.5% of reading (see note)

**Compensation range:** For input capacitance of 6 pF to 50 pF.

**Crest factor:** 2 or less

Note: Characteristic applies for operation between 0 $^\circ$  and 55 $^\circ$  C, at less than 85% relative humidity. For operation above 40 $^\circ$  C, at 85% to 95% relative humidity, add additional 10% of reading.

#### General

##### Operating modes:

1 M $\Omega$  mode, for oscilloscope impedance of 1 M $\Omega$   $\pm$  1%

10 M $\Omega$  mode (optional), for input impedance of 10 M $\Omega$   $\pm$  1%

**Operating temperature range:** 0 $^\circ$  to 55 $^\circ$  C

**Storage temperature range:** -20 $^\circ$  to 70 $^\circ$  C

**Cable length:** 1.5 meters

**Accessories:** Trimmer adjustment tool included

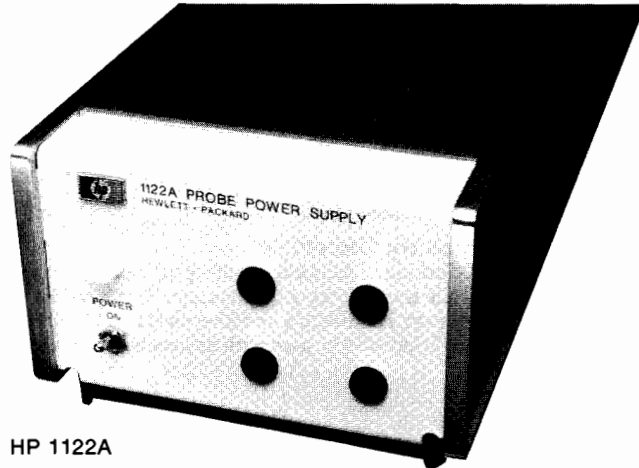

HP 1122A

### HP 1122A Probe Power Supply

The HP 1122A is a regulated power supply that provides all power requirements for simultaneous operation of up to four active probes.

#### HP 1122A Specifications

Probe driving capability: up to four HP active probes.

Power output: -12.6 V and +15 V,  $\pm$ 3%.

Power input: 115 V or 230 V  $\pm$ 10%, 48 to 440 Hz, 40 W (with four probes).

Weight: net, 2.7 kg (6 lb); shipping 3.6 kg (8 lb).

#### Ordering Information

HP 10002A 1000V 50:1 voltage divider probe

HP 10020A resistive divider probe kit

HP 10240B blocking capacitor

HP 1124A 100 MHz active probe

HP 1122A probe power supply

HP 1137A 1000:1 high voltage divider probe

#### Price

\$230

\$495

\$45

\$350

\$1,235

\$150

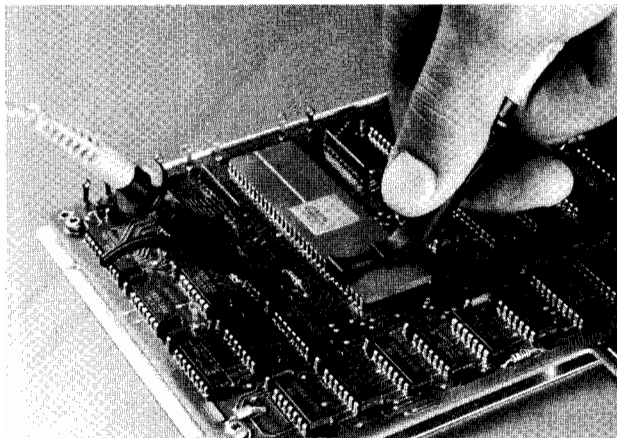

**HP 10400A Family Accessories**

Each 10400A family probe is shipped with one general purpose grabber, one IC grabber, and one ground lead. An accessory package is also included which contains 4 grounding spanners (for close grounds at the probe tip), 1 probe barrel insulator, 1 adjustment screwdriver, and 8 colored cable markers.

The photo above illustrates use of the IC grabber. This device fits DIPs with 0.1 inch pin spacing (standard) and up to 0.9 inch package width. It is handy for connecting the mini-probe tip to a single DIP pin. Construction prevents shorting adjacent pins during hook-up. For applications where several adjacent DIP pins must be probed, the 10024A accessory can be used (see page 76).

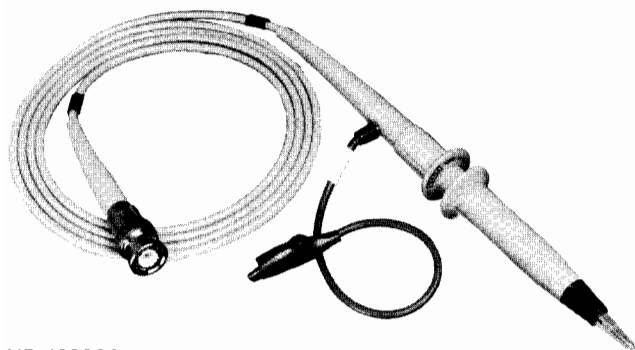

HP 10002A

**HP 10002A 1000V 50:1 Voltage Divider Probe**

The HP 10002A voltage divider probe is a general purpose probe for use with instruments that have a bandwidth of less than 40 MHz with an input impedance of 1 megohm shunted by approximately 15 to 55 pF. The probe is rated at 1000V peak.

**HP 10020A Resistive Divider Probe Kit**

The HP 10020A Resistive Divider Kit is a signal probing system for measuring fast transition signals in high impedance systems. It is designed for use with 50 Ω input oscilloscopes, but may be used with other than 50 Ω systems if a 50 Ω feedthrough termination (HP 10100C) is used. The extremely low input RC of the 10020A provides high fidelity measurements of fast transition signals.

**Probe length (overall):** 1.2 m (4 ft).

**Weight:** net, 0.45 kg (1 lb); shipping, 1.4 kg (3 lb).

**Accessories supplied:** HP 10240B blocking capacitor, BNC adapter tip, 6-32 adapter tip, alligator tip, probe handle, cable ass'y's 5.1 cm (2 in) & 15.2 cm (6 in) ground, spanner tip, insulating caps, colored sleeves.

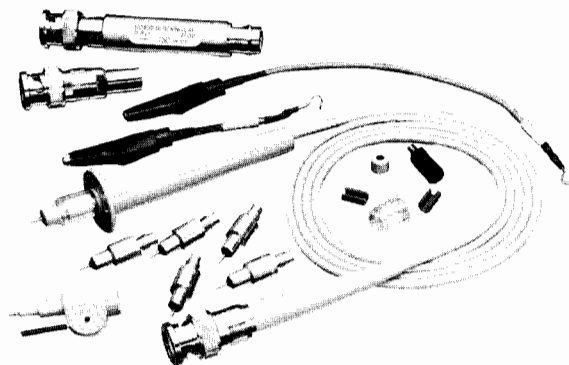

The HP 10020A Resistive Divider Probe Kit (includes HP 10240B)

**HP 10020A Resistive Dividers**

Division Ratio	Input R* (ohms)	Division Accuracy	Max V** (rms)	Input C (pF)
1:1	50	—	6	—
5:1	250	±3%	9	<0.7
10:1	500	±3%	12	<0.7
20:1	1000	±3%	15	<0.7
50:1	2500	±3%	25	<0.7
100:1	5000	±3%	35	<0.7

\*When terminated in 50 ohms.

\*\*Limited by power dissipation of resistive element.

**HP 10240B Blocking Capacitor**

The HP 10240B blocking capacitor is a probing accessory that provides ac coupling while maintaining a 50 Ω system. This capacitor is designed for use with the HP 10020A resistive divider kit, and it is included with the kit. It can also be used with any probe that must be terminated in 50 Ω.

**Characteristics**

**Capacitance:** 0.18 μF

**Maximum voltage:** ± 200 Vdc

**Reflection:** Under 12% when driven by a 150 ps rise time step in a 50 Ω system.

**Sag:** Approximately 10% per μs (1% in 100 ns)

**Connectors:** BNC

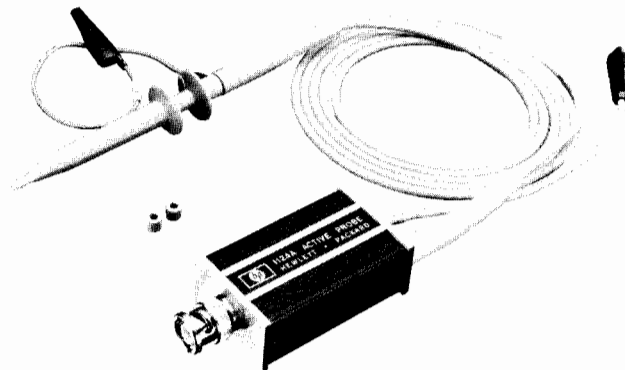

**HP 1124A 100 MHz Active Divider Probe**

The HP 1124A active divider probe provides high voltage, general-purpose probing capabilities for instruments having 50 Ω inputs without selectable high impedance inputs. This 10 MΩ 10 pF probe allows direct measurements of 100 V, in the 100:1 division ratio mode, from dc to 100 MHz. In the 10:1 division ratio mode, input voltage range is ±10 V. Power is supplied by instruments with probe power jacks or the HP 1122A probe power supply.

# OSCILLOSCOPES & WAVEFORM ANALYZERS

## Oscilloscope Probes and Accessories

### Oscilloscope Probes

- Modular construction
- Improved electrical performance
- Accessories

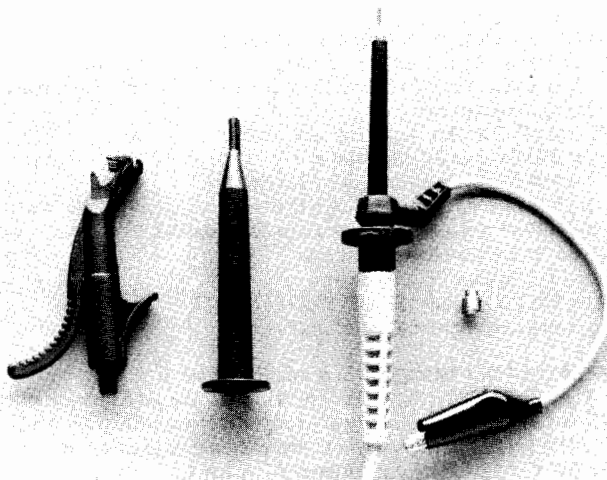

### HP 10400A Miniature Probe Family

The HP 10400A miniature probe family offers modular construction, improved reliability, and superior electrical performance over our previous mini-probes. Modular construction allows individual replacement of probe tips, cables, and chassis assemblies cutting down on probe replacement and repair costs. An extra tip is included for quick repair of broken tip. Improved cable and strain relief design increase reliability. Electrical performance is also improved by reducing the probe shunt capacitance and increasing the input resistance that load the circuit under test.

The HP 10400A mini-probe family also features accessories (see below) including a ground lead utilizing a ferrite bead for reduced ringing on pulse tops, and an IC grabber that allows easy connection of a single probe to many IC packages without fear of shorting adjacent pins.

### OSCILLOSCOPE/MINIATURE PROBE COMPATIBILITY AND PROBE CHARACTERISTICS

HP Oscilloscope/ Logic Analyzer	HP probe model	Approx overall length in meters (ft)	Division ratio	Input R	Approx shunt capacitance	Compensates oscilloscope input	max <sup>1</sup> dc volts	Price	
Same as HP 10431A but without probe identification 54502A, 54503A, 54504A, 54510A	HP 10430A	1m (3.3)	10:1	1M $\Omega$	6.5 pF	1M 6-9 pF	450	\$135	☎
54111D, 54112D	HP 10431A <sup>2</sup>	1m (3.3)	10:1	1M $\Omega$	6.5 pF	1M 6-9 pF	450	\$145	☎
1631A/D, 1715A, 1722A, 1725A 1726A, 1727A, 1805/09A 54200/201, 54501A, 5185	HP 10432A <sup>3</sup>	1m (3.3)	10:1	10 M $\Omega$	7.5 pF	1M 10-16 pF	450	\$125	☎
1631A/D, 16530/31, 5185 54003A, 54200/201, 54501A	HP 10433A	2m (6.6)	10:1	10 M $\Omega$	10 pF	1M 10-16 pF	450	\$135	☎
1740A, 1741A, 1742A, 1743A 1744A, 1745A, 1746A	HP 10434A	1m (3.3)	10:1	10 M $\Omega$	8.5 pF	1M 18-22 pF	450	\$125	☎
1631A/D, 1715/22/25/26/27 1805/09, 54200/201, 5185	HP 10435A <sup>3</sup>	1m (3.3)	10:1	1 M $\Omega$	7.5 pF	1M 10-16 pF	450	\$125	☎
1740/41/42/43/44/45/46	HP 10436A	2m (6.6)	10:1	10 M $\Omega$	11 pF	1M 18-22 pF	450	\$130	☎
For oscilloscopes with 50 $\Omega$ inputs	HP 10437A	2m (6.6)	1:1	50 $\Omega$				\$90	☎
All scopes with high Z inputs (may reduce bandwidth)	HP 10438A HP 10439A	1m (3.3) 2m (6.6)	1:1 1:1		40 pF 64 pF		450 450	\$100 \$105	☎
1631A/D, 1715A, 1722A, 1725A 1726A, 1727A, 1805/09A 1950A, 54112D <sup>4</sup> , 54003A, 54111D <sup>4</sup> , 54200/201A/D <sup>4</sup> , 54502A, 54503A, 54504A, 54510A	HP 10440A	2m (6.6)	100:1	10 M $\Omega$	2.5 pF	1M 6-14 pF	450	\$135	☎
5411D, 54112D 54502A, 54503A, 54504A, 54510A	HP 10441A <sup>2</sup>	2m (6.6)	10:1	1 M $\Omega$	9.0 pF	1M 6-9 pF	450	\$160	☎

Note 1: Maximum input voltage may be limited by scope input maximum volt.

<sup>2</sup>Has probe identification pin.

<sup>3</sup>The HP 54201A/D can use the HP 10432A or HP 10435A probes for the vertical inputs, but the HP 10435A probe must be used for trigger inputs.

<sup>4</sup>For vertical inputs only

☎ For same-day shipment, call HP DIRECT at 800-538-8787.

### HP 54120B includes:

- Color mainframe
- Interface cable
- Service manual for the HP 54120B (HP 54120-90907)
- Power cord

### HP 54121A includes:

- Operating and programming manuals for the HP 54121T
- Service manual for the HP 54121A
- Four channels, switchable step generator, and a trigger input
- Five adapters, APC-3.5 (f-f) (HP 5061-5311)
- Five coaxial shorts, SMA (m) (HP 0960-0055)
- One anti-static mat with wrist strap (HP 9300-1484)
- RF accessories (HP 54121-68701):
  - Five 20 dB attenuators, APC-3.5 (f-m) (HP 33340C opt 020)
  - Three 50 Ω cables, SMA (m-m) (HP 8120-4948)
  - Two SMA (m) to BNC (f) adapters (HP 1250-1200)
  - One 50 Ω termination, SMA (m) (HP 1250-2153)
  - One 50 Ω termination, SMA (f) (HP 1250-2151)
  - One coaxial short, SMA (f) (HP 1250-2152)

### HP 54121T specific documentation

- HP 54121T Front-panel manual (HP 54121-90903)
- HP 54121T Programming manual (HP 54121-90904)
- HP 54121A service manual (HP 54121-90902)

### HP 54122A includes:

- Operating and programming manuals for the HP 54122T
- Service manual for the HP 54122A
- Four vertical channels, internal attenuators, and a trigger input
- Five adapters, APC-3.5 (f-f) (HP 5061-5311)
- Five coaxial shorts, SMA (m) (HP 0960-0055)
- One anti-static mat with wrist strap (HP 9300-1484)
- RF accessories (HP 54122-68701):
  - One 20 dB attenuator, APC 3.5 (f-m) (HP 33340C opt. 020)
  - Three 50 Ω cables, SMA (m-m) (HP 8120-4948)
  - Five SMA (m) to BNC (f) adapters (HP 1250-1200)

### HP 54122T specific documentation

- HP 54122T front-panel manual (HP 54122-90903)
- HP 54122T programming manual (HP 54122-90904)
- HP 54122A Service manual (HP 54122-90901)

### HP 54123A includes:

- Operating and programming manuals for the HP 54123T
- Service manual for the HP 54123A
- Four channels, switchable step generator, and a trigger input
- Five adapters, APC-3.5 (f-f) (HP 5061-5311)
- Five coaxial shorts, SMA (m) (HP 0960-0055)
- One anti-static mat with wrist strap (HP 9300-1484)
- RF accessories (HP 54121-68701) See list under HP 54121A above.

### HP 54123T specific documentation

- HP 54123T front-panel reference manual (HP 54123-90902)
- HP 54123T programming manual (HP 54123-90903)
- HP 54123A service manual (HP 54123-90901)

### HP 54124A includes:

- Operating and programming manuals for the HP 54124T
- Service manual for the HP 54124A
- Four channels, switchable step generator, and a trigger input
- Three adapters, APC-3.5 (f-f) (HP 5061-5311)
- Two adapters, 2.4 (f-f) (HP 11900B)
- Three coaxial shorts, SMA (m) (HP 0960-0055)
- Two coaxial caps, 2.4 mm (HP 54124-24101)
- One anti-static mat with wrist strap (HP 9300-1484)
- RF accessories (HP 54121-68701): See list above

### HP 54124T specific documentation

- HP 54124T front-panel reference manual (HP 54124-90902)
- HP 54124T programming manual (HP 54124-90903)
- HP 54124A service manual (HP 54124-90901)

### Ordering Information

HP 54120B Digitizing oscilloscope mainframe	\$11,900
Opt 908 Rackmount kit (HP 5061-9679)	+\$40
Opt 910 One additional set of manuals	+\$20

### HP 54121T 20 GHz digitizing oscilloscope

The HP 54121T 20 GHz Digitizing Oscilloscope consists of the HP 54120B and the HP 54121A. The HP 54121T is the recommended ordering configuration.

HP 54121T 20 GHz digitizing oscilloscope	\$29,100
Opt 090 Deletes RF accessories	-\$1,800
Opt 908 Rackmount kits (HP 5061-9672)	+\$89
Opt 910 One additional set of manuals	+\$120
Opt +W30 Extended repair service. See page 723.	\$695
HP 54121A Four-channel test set	\$17,200
Opt 090 deletes RF accessories	-\$1,800
Opt 908 rackmount kit (HP 5061-9672)	+\$49
Opt 910 one additional set of manuals	+\$100

### HP 54122T 12.4 GHz digitizing oscilloscope

The HP 54122T 12.4 GHz Digitizing Oscilloscope consists of the HP 54120B digitizing oscilloscope mainframe and the HP 54122A. The HP 54122T is the recommended ordering configuration.

HP 54122T 12.4 GHz digitizing oscilloscope	\$29,100
Opt 090 delete RF accessories	-\$700
Opt 908 rackmount kits (1 ea HP 5061-9672)	+\$89
Opt 910 one additional set of manuals	+\$120
Opt +W30 extended repair service. See page 723.	\$695
HP 54122A Four-channel test set	\$17,200
Opt 090 delete RF accessories	-\$700
Opt 908 rackmount kit (HP 5061-9672)	+\$49
Opt 910 one additional set of manuals	+\$100

### HP 54123T 34 GHz digitizing oscilloscope

The HP 54123T 34 GHz Digitizing Oscilloscope consists of the HP 54120B and the HP 54123A. The HP 54123T is the recommended ordering configuration.

HP 54123T 34 GHz Digitizing Oscilloscope	\$35,100
Opt 090 delete RF accessories	-\$1,800
Opt 908 rackmount kit (HP 5061-9672)	+\$89
Opt 910 one additional operating and programming manual	+\$120
Opt +W30 extended repair service. See page 723.	+\$865
HP 54123A four-channel test set	\$23,200
Opt 090 delete RF accessories	-\$1,800
Opt 908 rackmount kit (HP 5061-9672)	+\$49
Opt 910 one additional set of manuals	+\$100

### HP 54124T 50 GHz digitizing oscilloscope

The HP 54124T 50 GHz digitizing oscilloscope consists of HP 54120B and the HP 54124A. The HP 54124T is the recommended ordering configuration.

HP 54124T 50 GHz digitizing oscilloscope	\$42,800
Opt 090 deletes RF accessories	-\$1,800
Opt 908 rackmount kits (HP 5061-9672)	+\$89
Opt 910 one additional set of manuals	+\$120
Opt +W30 Extended repair service. See page 723.	+\$1055
HP 54124A Four-channel test set	\$30,900
Opt delete RF accessories	-\$1,800
Opt 908 rackmount kit (HP 5061-9672)	+\$49

### Accessories

HP 54006A 6 GHz resistive divider probe kit	\$895
HP 54007A accessory kit	\$5,225
HP 54008A 22 ns delay line	\$2,600
HP 54118A 18 GHz trigger	\$8,925
Opt 090 delete RF accessories	-\$1,250
Opt 908 rackmount kit (HP 5061-9672)	+\$49
Opt 910 one additional manual	+\$15
HP 10086A ECL terminator	\$637

For additional information concerning any high-bandwidth oscilloscope accessory, see HP publication number 5952-7084.



# OSCILLOSCOPES & WAVEFORM ANALYZERS

## Accessories For The HP 54120 Series Digitizing Oscilloscopes

HP 54006A, 54007A, 54008A, 54118A, 10086A

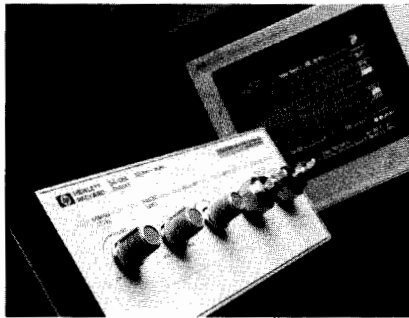

HP 54118A

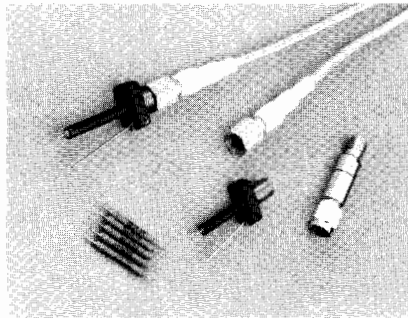

HP 54006A

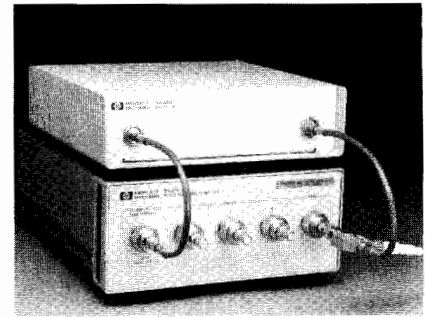

HP 54008A

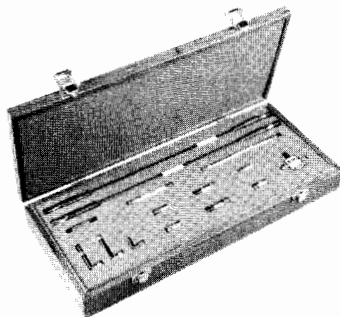

HP 54007A

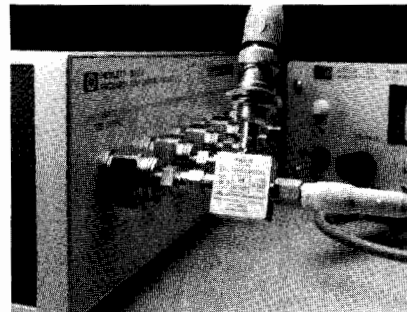

HP 10086A

Hewlett-Packard has a large number of accessories for use with wideband digital sampling oscilloscopes that will help you build a multi-gigahertz system that is tailored to your unique needs.

### HP 54118A, 500 MHz to 18 GHz Trigger

#### Simple/Stable Triggering at Microwave Frequencies

For applications requiring more than 2.5 GHz trigger bandwidth, use the HP 54118A 18 GHz Trigger. The HP 54118A gives your HP 54120-series oscilloscope true event triggering from 500 MHz to 18 GHz with less than 1.7 ps of rms jitter at 18 GHz. This powerful and versatile accessory extends the oscilloscope's measurement capabilities to applications in lightwave communications, pulsed RF, gigabit logic, pseudo random bit stream eye patterns, and other microwave signals.

True event triggering is not possible with countdown synchronizers, but with the event triggering capability of the HP 54118A, you are no longer restricted to the limitations of countdown synchronizers. An HP microwave thinfilm IC locks onto your input signal and holds it, even if the signal has frequency drift or large deviations in FM modulation.

Independent control of arming and triggering levels let you make measurements that simply were not possible before, such as triggering on a carrier of a radar pulse or CW signals with large noise components. And the trigger's variable holdoff feature makes it a snap to trigger on the carrier of a burst RF signal.

### HP 54006A 6 GHz Probe

#### High Frequency Hand-held Probing

Probing multi-GHz systems with the HP 54006A, 10:1, 500  $\Omega$  and 20:1, 1 k $\Omega$  resistive divider probes lets you access circuit nodes that do not have a 50  $\Omega$  connector. These probes let you see the signal at specific points, such as the input to a gate. You can also use them to probe circuits that are not nominally 50  $\Omega$ .

### HP 54008A 22 ns Delay Line

#### Viewing the Trigger Signal

The HP 54008A delay line provides 22 ns of delay with a usable frequency response of 20 GHz. By adding this accessory to your HP 54120 oscilloscope system, you will be able to view the trigger event. The HP 54008A has enough delay to view the trigger event with the HP 54118A Trigger installed in the trigger path also.

### HP 54007A Accessory Kit

#### Low-loss Measurements For the HP 54120 Oscilloscope Systems

The HP 54007A Accessory Kit provides an assortment of parts with 3.5 mm connectors for low-loss measurements. This kit is highly recommended for low-loss reflection and transmission measurements. It also includes semi-rigid coax, formed for use with the HP 11667B power splitter.

#### Contents of HP 54007A Accessory Kit:

17-inch cable, APC 3.5 (f-f)	17-inch cable, APC 3.5 (m-f)
Coaxial short, APC 3.5 (f)	Coaxial short, APC 3.5 mm (m)
50 $\Omega$ termination, APC 3.5 (m)	50 $\Omega$ termination, APC 3.5 (f)
7.5 cm airline, APC 3.5 (m-f)	Power splitter, APC 3.5 mm (f)
6 cm. semi-rigid "L", SMA (m-m)	3 cm. semi-rigid "L", SMA (m-m)
6 dB attenuator, APC 3.5 (m-f)	40 dB attenuator, APC 3.5 (m-f)
Adapter, APC 3.5 mm (m-m)	

### HP 10086A ECL Terminator

#### Safe, Reliable Termination For Measuring ECL Devices

Create a simple high-performance 10 GHz interface between an ECL-compatible output and a 50  $\Omega$  instrument input. The ECL terminator provides bias and termination for your device under test, while presenting an undistorted and level-shifted signal to your measurement equipment. It also provides proper termination to ECL output devices, thereby reducing the risk of destroying sensitive output devices.

## HP 54120-Series Specifications

### Vertical (channels)<sup>1</sup>

	HP 54121T	HP 54122T	HP 54123T	HP 54124T
<b>dc-coupled Bandwidth</b> (-3 dB) <sup>2</sup>				
High bandwidth				
Chan 1	18.0 GHz	12.4 GHz	20.0 GHz	20.0 GHz
Chan 2	20.0 GHz	12.4 GHz	34.0 GHz	34.0 GHz
Chan 3,4	20.0 GHz	12.4 GHz	34.0 GHz	50.0 GHz
Low bandwidth				
Chan 1	12.4 GHz	10.0 GHz	12.4 GHz	12.4 GHz
Chan 2	12.4 GHz	10.0 GHz	18.0 GHz	18.0 GHz
Chan 3,4	12.4 GHz	10.0 GHz	18.0 GHz	26.5 GHz
<b>Transition time</b> (10% to 90%) (calculated from $T_r = .35/BW$ )				
High bandwidth				
Chan 1	19.4 ps	28.2 ps	17.5 ps	17.5 ps
Chan 2	17.5 ps	28.2 ps	10.3 ps	10.3 ps
Chan 3,4	17.5 ps	28.2 ps	10.3 ps	7.0 ps
Low bandwidth				
Chan 1	28.2 ps	35.0 ps	28.2 ps	28.2 ps
Chan 2	28.2 ps	35.0 ps	19.4 ps	19.4 ps
Chan 3,4	28.2 ps	35.0 ps	19.4 ps	13.2 ps
<b>Noise (rms)</b>				
High bandwidth	≤2 mV	≤2 mV (1:1 attenuation)	≤2 mV	≤2 mV
Low bandwidth	≤1 mV	≤1 mV (1:1 attenuation)	≤1 mV	≤1 mV
<b>Scale factor</b> (full-scale is 8 divisions)				
Minimum	1 mV/div	1 mV/div	1 mV/div	1 mV/div
Maximum	80 mV/div	2.4 V/div	80 mV/div	80 mV/div
<b>Attenuation factors</b>				
	N/A	X1, X3, X10, X30	N/A	N/A
<b>Programmable dc offset<sup>3</sup></b>				
	± 500 mV	± 500 mV × atten. factor	± 500 mV	± 500 mV
<b>dc accuracy</b>				
Single Voltage Marker <sup>4</sup>	Average mode: ± <b>0.4% of full-scale</b> or marker reading (whichever is greater) ± 2 mV × attenuation factor <sup>5</sup>			
	High bandwidth persistence mode: ± <b>0.4% of full-scale</b> or marker reading (whichever is greater) ± 2 mV × attenuation factor <sup>5</sup> ± 3.0% of <sup>6</sup> (reading - channel offset) <sup>7</sup>		Low bandwidth persistence mode: ± <b>0.4% of full-scale</b> or marker reading (whichever is greater) ± 2 mV × attenuation factor <sup>5</sup> ± 1.5% of <sup>6</sup> (reading - channel offset) <sup>7</sup>	
<b>Inputs</b>				
Number	4	4	4	4
Dynamic range	± 320 mV relative to channel offset	± 320 mV × attenuation factor	± 320 mV relative to channel offset	± 320 mV relative to channel offset
Maximum safe input voltage	± 2 V dc + peak ac (+16 dBm)	± 5 V dc + peak ac (+24 dBm)	± 2 V dc + peak ac (+16 dBm)	± 2 V dc + peak ac (+16 dBm)
Nominal impedance	50 Ω	50 Ω	50 Ω	50 Ω
Percent reflection	≤5% for 30 ps rise time	≤5% for 30 ps rise time	≤5% for 30 ps rise time	≤5% for 30/20 ps rise time
Connectors	3.5 mm (m)	3.5 mm (m)	3.5 mm (m)	3.5 mm/2.4 mm (m)

<sup>1</sup> When operated within ± 5° C (± 9° F) of the temperature of the last front panel calibration.

<sup>2</sup> The input samplers are biased differently for increased bandwidth in the high bandwidth mode.

<sup>3</sup> An effective offset of ± 820 mV × attenuation factor can be achieved by using the ± 500 × attenuation factor mV of channel offset and adding ± 320 mV × attenuation factor of offset with the waveform math offset scaling function.<sup>5</sup>

<sup>4</sup> When driven from a 0 Ω source.

<sup>5</sup> The attenuation factor of the HP 54121T, 54123T, and 54124T is 1.

<sup>6</sup> For the HP 54123T and 54124T, the 3% changes to 5% and the 1.5% changes to 2%.

<sup>7</sup> Performing a vertical software calibration immediately before making a measurement eliminates the final term in the persistence mode dc accuracy specification.

## TDR System (HP 54121T, HP 54123T, and HP 54124T only)

	Combined oscilloscope and TDR performance	Normalized characteristics <sup>1</sup>
<b>Rise time<sup>2,3</sup></b>	≤45 ps	Adjustable: allowable values based on time base setting Minimum: 10 ps or 0.08 × time/div, whichever is greater Maximum: 5 × time/div
<b>Flatness<sup>2</sup></b>	≤+ 1% after 1 ns from edge; ≤+ 5%, -3% to 1 ns from edge	≤ 0.1%
<b>Levels</b>		
low	0 V ± 2 mV	0 V ± 2 mV
high	+ 200 mV ± 2 mV	+ 200 mV ± 2 mV

<sup>1</sup> Normalized information is a characteristic, not a specification. The information is presented here for comparison purposes only. Normalization characteristics are achieved only with the use of the normalization calibrations and firmware routines.

<sup>2</sup> Measured in the low bandwidth and average display modes.

<sup>3</sup> The risetime of the generator is less than 35 ps, as calculated by  $(Tr \text{ system})^2 = (Tr \text{ generator})^2 + (Tr \text{ scope})^2$

### Horizontal (time base)

<b>Scale factor</b> (full-scale is 10 divisions)	10 ps/division to 1 s/division
<b>Delay</b> (time offset relative to trigger)	16 ns to 10 s or 1000 screen diameters, whichever is smaller
<b>Time interval accuracy</b>	≤10 ps ± 0.1% of reading (Dual marker measurement)
<b>Time Interval Resolution</b>	0.25 ps <sup>1</sup> or 0.02 division, whichever is larger

<sup>1</sup> At 10 ps/division, data points are plotted at 0.2 ps intervals to match the display pixel resolution.

### Trigger-external input only

<b>Sensitivity</b>	dc - 100 MHz 100 MHz to 2.5 GHz	40 mV peak-to-peak Increasing linearly from 40 mV at 100 MHz to 200 mV at 2.5 GHz
<b>Pulse width</b>		200 ps, ≥ 200 mV
<b>High frequency reject</b>		Trigger bandwidth reduced to approximately 100 MHz.
<b>Trigger level range</b>		± 1 V
<b>Jitter</b> (Trigger and time base combined) (one standard deviation)		≤ 2.5 ps + 5E-5 × delay setting (Tested using 2 GHz synthesized source at 200 mV peak-to-peak with High Frequency Sensitivity ON and High Frequency Reject OFF.)
<b>Trigger input</b>		
Maximum safe input voltage		± 2 V dc + ac peak (+16 dBm)
Nominal impedance		50 Ω
Percent reflection		≤10% for 100 ps rise time
Connector		3.5 mm (m)

# OSCILLOSCOPES & WAVEFORM ANALYZERS

## Digitizing Oscilloscopes (cont'd)

HP 54121T, 54122T, 54123T and 54124T

- 50 GHz, 34 GHz, 20 GHz and 12.4 GHz bandwidths
- 0.25 ps timing resolution
- Built-in histograms
- 2.5 GHz edge trigger
- Time domain reflectometry
- HP PaintJet printer output

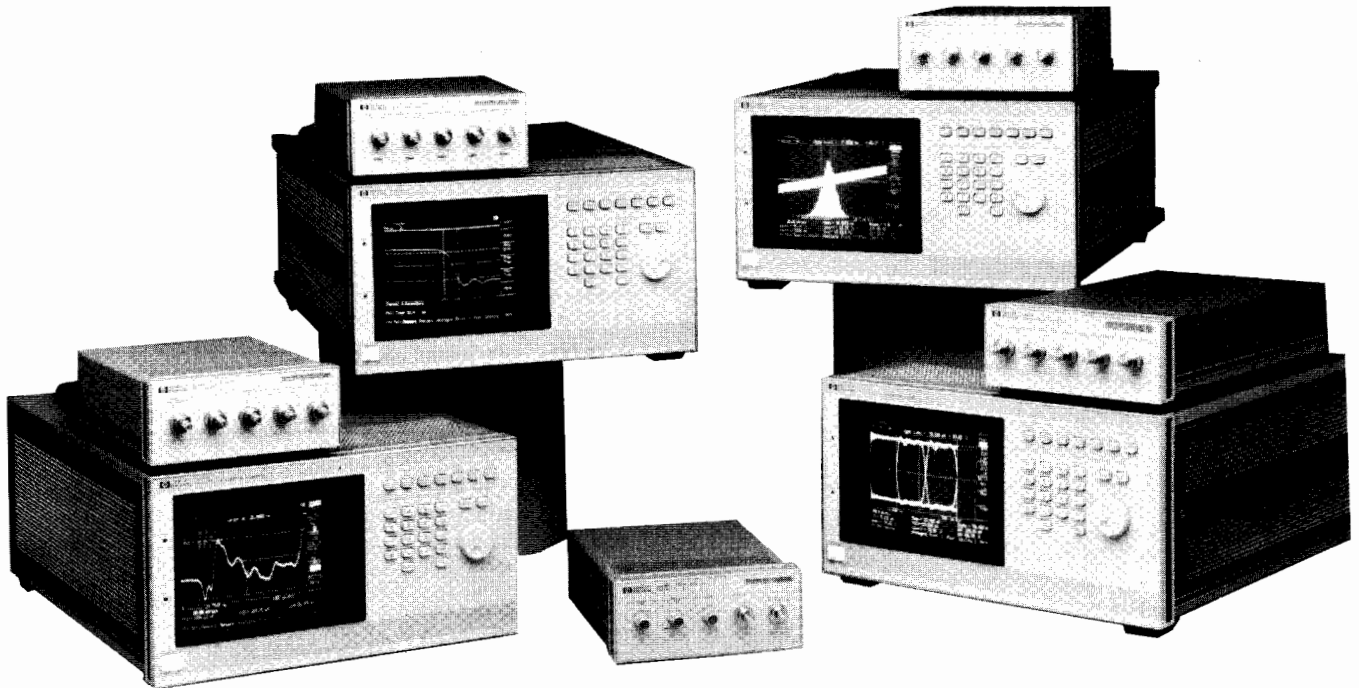

The HP 54120-series of high bandwidth digitizing oscilloscopes featuring digital feedback sampling for repeatable, accurate, and operator-independent measurement results.

### HP 54120-series High Bandwidth Digitizing Oscilloscopes

The HP 54120-series of digitizing oscilloscopes combines high bandwidth, a time domain reflectometer (HP 54121T and HP 54123T and 54124T only), four input channels, and superb stability in an easy-to-use, fully programmable oscilloscope that needs no manual loop gain adjustment. Whether your application involves high-speed device and circuit characterization, high-speed telecom analysis, or microwave design, the HP 54120-series of digitizing oscilloscopes give you a new confidence in state-of-the-art measurements.

#### Key Contributions

- dc - 50 GHz bandwidth (HP 54124T) - 7 ps rise time
- dc - 34 GHz bandwidth (HP 54123T) - 10.3 ps rise time
- dc - 20 GHz bandwidth (HP 54121T) - 17.5 ps rise time
- dc - 12.4 GHz bandwidth (HP 54122T) - 28.2 ps rise time
- 10 ps time interval accuracy
- 0.25 ps time interval resolution
- 10 ps/div to 1 s/div
- 0.4 % vertical accuracy
- 32 microvolt resolution
- 1 mV/div to 80 mV/div (HP 54121T, HP 54123T and HP 54124T)
- 1 mV/div to 2.4 V/div (HP 54122T)
- Automatic pulse parameter measurements
- Fully HP-IB programmable
- Pushbutton hardcopy documentation

- Four input channels
- Step generator with typically 35 ps risetime and typically 1% flatness (HP 54121T, HP 54123T and HP 54124T)
- Reflection (TDR)/transmission (TDT) normalization<sup>1</sup> (HP 54121T, HP 54123T and HP 54124T)
- Time and voltage histograms

#### Picosecond measurements

The 0.25 ps time interval resolution and typically 1 ps time interval accuracy of the HP 54120 family reduce the oscilloscope's contribution to errors in digital pulse parameter measurements in semiconductors and computers.

#### Quantify Noise and Jitter

Time and voltage histograms, which quantify noise and jitter measurements, characterize the eye patterns in telecommunications applications. Eye height and width, location of one and zero, are easily found with histograms. With no loop gain control, you can obtain repeatable results that do not vary between operators or between oscilloscopes over the entire input dynamic range.

#### Eliminate Reflections with TDR

Ringings and waveform distortion can be eliminated by using time domain reflectometry on the HP 54121T, the HP 54123T, and the HP 54124T to locate and remove discontinuities in transmission line systems.

NOTE 1: Normalization uses the Bracewell transform, which is under license from Stanford University.

# OSCILLOSCOPES & WAVEFORM ANALYZERS

Digitizing Oscilloscopes

HP 54112D

67

- 64k memory depth per channel
- Quad 400 megasamples per second digitizers
- Four channels.

- 100 MHz bandwidth (single-shot and repetitive)
- HP PaintJet printer color output

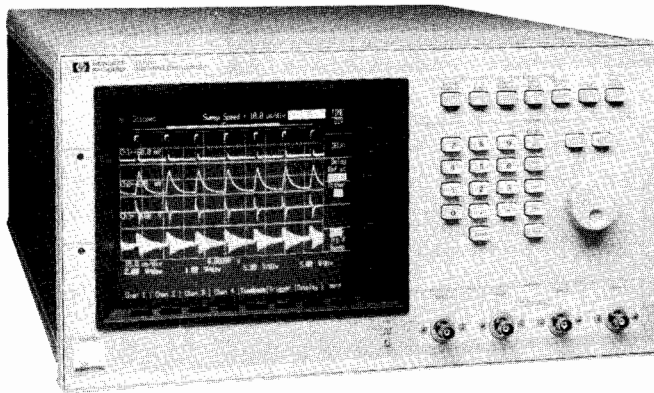

HP 54112D



## HP 54112D Digitizing Oscilloscope

### Four channels, deep memory

The HP 54112D is a 400 megasample-per-second (MSa/s), four-channel digitizing oscilloscope with 64k samples of memory depth per channel. The HP 54112D retains all the key features and the user friendliness of the HP 54100 series scopes. These features include automatic measurements, autoscaling, cursors, functional color display, scroll, zoom, and memory bar.

### Key Contributions

- 400 megasamples per second digitizing rate
- 100 MHz repetitive and single-shot bandwidth
- 64k memory per channel
- Four channels of simultaneous capture at the full digitizing rate
- 160  $\mu$ s of pre- or post-trigger information minimum
- Automatic measurements
- Fully programmable
- Advanced logic triggering capabilities
- Instant hardcopy output

### Automatic Test Environment

The English-like commands and the logical structure of the HPOL (Hewlett-Packard Oscilloscope Language) make it easier to program the 54100 series oscilloscopes in computer aided test. The learning curve is greatly reduced.

The four channels, built-in automatic measurements, and very deep memory of the 54112D improve the throughput of ATE systems. Data that used to take many acquisition passes can now be captured in one pass.

### General-Purpose Inputs

The fully programmable input impedance and coupling of the four channels allow the user to choose 1 megohm impedance ac or dc coupled or 50 ohm dc-coupled on each channel.

## HP 54112D Specifications

Vertical (voltage)	Single-shot	Repetitive
<b>Number of channels</b>	4	4
<b>Bandwidth</b>		
dc-coupled	dc to 100 MHz	dc to 100 MHz
ac-coupled	10 Hz to 100 MHz	10 Hz to 100 MHz
<b>Transition time (10% to 90%)</b>	3.5 ns (nominal)	3.5 ns (nominal)
<b>Deflection factor (full scale=8 div)</b>	5 mV/div to 5 V/div continuous	
<b>Vertical resolution</b>	6 bits	6 bits, 8 bits with averaging
<b>Vertical gain accuracy</b>	$\pm 2\%$ of full-scale <sup>1</sup>	
<b>dc offset accuracy</b>	$\pm 1.5\%$ of setting	
<b>Measurement accuracy</b>		
single data point between data points on same waveform	$\pm$ gain accuracy $\pm$ offset accuracy $\pm$ resolution $\pm$ gain acc $\pm 2 \times$ resolution	
<b>dc offset range</b>	$\pm 1$ V (5 mV/div to 49 mV/div) $\pm 10$ V (50 mV/div to 0.49 V/div) $\pm 40$ V (0.5 V/div to 5 V/div)	
<b>Input coupling</b>	ac/dc/dc-50 $\Omega$	
<b>Input impedance</b>	1 M $\Omega$ at 6.5 pF or 50 $\Omega$	
<b>Maximum input voltage</b>	1 M $\Omega$ : $\pm 40$ V [dc & peak ac] 50 $\Omega$ : 5 Vrms	
<sup>1</sup> When calibrated to probe tip using front panel calibration source. Applies to major ranges (5 mV, 10 mV, 20 mV, 50 mV, 100 mV, 200 mV, 500 mV, 1 V and 2 V). All continuous settings between these ranges are $\pm 3\%$ of full scale.		
<b>Horizontal (time)</b>		
<b>Digitizing rate</b>	400 MSa/s to 50 Sa/s	
<b>Memory depth per channel</b>	either 64k or 8k, single-shot only	
<b>Delay range (pre-trigger)</b>	-160 $\mu$ s at 125 ns/div and less, increasing to -1200 s at 1 s/div	
<b>Delay range (post-trigger)</b>	0.16 s at 0.5 $\mu$ s/div and less, increasing to 10,000 s at 1 s/div	
<b>Time measurement accuracy</b>		
single channel	$\pm 500$ ps $\pm 0.002\%$ of reading	
dual channel	$\pm 1$ ns $\pm 0.002\%$ of reading	
<b>Triggering</b>	<b>Internal</b>	<b>External</b>
<b>Sources</b>	channels 1,2,3,4	input rear-panel
<b>Sensitivity</b>	0.1 x full-scale	10 mV (1:1)
<b>Trigger level range</b>	$\pm 3$ x full-scale	$\pm 5$ V (1:1)
<b>Input resistance</b>	not applicable	200 k $\Omega$
<b>Maximum input voltage</b>	not applicable	$\pm 40$ V (dc + peak ac)
<b>Input operating range</b>	not applicable	$\pm 5$ V (1:1) [dc + peak ac]

## Ordering Information

HP 54112D 4 channel 64k memory/channel digitizing oscilloscope.

Opt W30 Extended repair service. See page 723.

## Price

\$22,900

+\$575

# OSCILLOSCOPES & WAVEFORM ANALYZERS

## Digitizing Oscilloscopes (cont'd)

HP 54111D

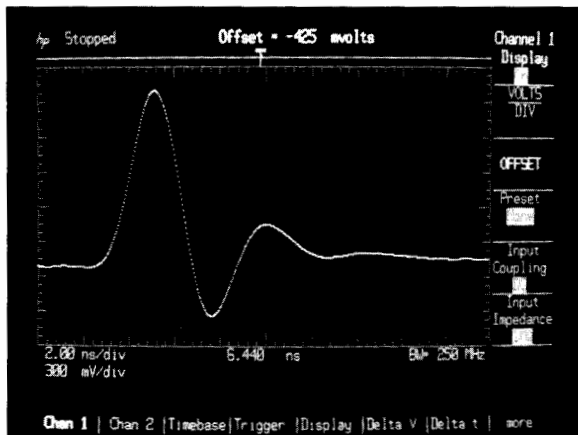

With a 1 gigasample/second digitizing rate, the HP 54111D captured this laser pulse single-shot.

### Data communications

Combine 2 gigasample/second (GSa/s) digitizing rate with eight kbytes of memory depth per channel, for an invaluable tool for analyzing high-speed serial waveforms such as data communications or radar testing.

### High bandwidth applications

Not only is the HP 54111D digitizing oscilloscope useful for single-shot phenomena, but it also samples repetitively, giving you 500 MHz bandwidth with high signal fidelity. Use this oscilloscope for general-purpose applications, from very slow to very high-speed repetitive or non-repetitive waveforms.

### Computer-aided test

The HP 54111D has many features that make it an excellent tool in computer-aided test. Its repetitive bandwidth and digitizing rate allow it to cover a wide range of automatic measurement applications. In addition, this instrument has many features that enhance test throughput time, such as built-in automatic measurements, fast acquisition cycles, and deep memory.

### Input range and conditioning

The HP 54111D has the widest input dynamic range and coupling capabilities of any HP digitizing oscilloscopes. The input sensitivity can be set from 1 mV/div to 5 V/div. All input coupling is internal and programmable. The selections include: ac, dc, 1 M $\Omega$ , 50 $\Omega$ , and ground. These input signal conditioning features make the HP 54111D more general-purpose for the circuit designer and test engineer.

### HP 54111D Specifications

Vertical (voltage)	Single-shot		Repetitive
	2 channel	1 channel with HP 54114A	
<b>Channels</b>		2	2
<b>Bandwidth</b>	250 MHz	500 MHz	500 MHz
<b>Transition time</b>	1.4 ns	700 ps	700 ps
<b>Vertical resolution</b>	8 bits/25 MHz, 7 bits/100 MHz, 6 bits/250 MHz	8 bits/50 MHz, 7 bits/200 MHz, 6 bits/500 MHz <sup>2</sup>	6 bits, 8 bits with averaging
<b>Vertical gain accuracy</b>	±2% of full-scale <sup>1</sup>		
<b>dc offset accuracy</b>	±1.5% of setting		
<b>Measurement accuracy</b>	±gain accuracy ± offset accuracy ± resolution		
single data point	±gain accuracy ± 2 × resolution		
between data points on the same waveform			
<b>dc offset range:</b>	±200 mV (1 mV/div to 4.9 mV/div)		
	±1 V (5 mV/div to 49 mV/div)		
	±10 V (50 mV/div to 0.49 V/div)		
	±100 V (0.5 V/div to 5 V/div)		

<b>Input coupling:</b>	ac/dc/dc-50 $\Omega$ /ground
<b>Input impedance:</b>	1 M $\Omega$ at 6.5 pF or 50 $\Omega$ (dc)
<b>Maximum input voltage</b>	1M $\Omega$ : ±40V [dc + peak ac] 50 $\Omega$ : 5Vrms

<b>Horizontal (time)</b>		
<b>Digitizing rate</b>	1 GSa/s to 50 Sa/s	
<b>Deflection factor</b>	500ps/div to 1 s/div	
<b>Memory depth per channel</b>	8k (8 $\mu$ s at 1GSa/s), single shot only	
<b>Delay range (pre-trigger)</b>	-8 $\mu$ s at 50 $\mu$ s/div and less, increasing to -160s at 1 s/div	
<b>Delay range (post-trigger)</b>	0.16s at 0.5 $\mu$ s/div and less, increasing to 10,000s at 1 s/div	
<b>Time measurement accuracy</b>		
single channel	single-shot ±300ps ±0.03% of reading	repetitive ±100ps ±0.03% of reading
dual channel	±600ps ±0.03% of reading	±200ps ±0.03% of reading

Triggering	Internal	External
<b>Sources</b>	channels 1, 2	inputs 3, 4
<b>Sensitivity</b>		
dc to 200MHz	0.1 × full scale <sup>2</sup>	15mV (1:1)
200MHz to 500MHz	0.2 × full scale <sup>2</sup>	45mV (1:1)
<b>Trigger level range</b>	±3 × full scale	±1V (1:1)
<b>Input resistance</b>	not applicable	1 M $\Omega$
<b>Maximum input voltage</b>	not applicable	±10V [dc + peak ac]
<b>Input operating range</b>	not applicable	±1V (1:1) [dc + peak ac]

<sup>1</sup>Raw Data

<sup>2</sup>When calibrated to probe tip using front panel calibration source. Applies to major ranges (5 mV/div, 10 mV/div, 20 mV/div, 50 mV/div, 100 mV/div, 200 mV/div, 500 mV/div, 1 V/div, and 2 V/div). All continuous settings between these ranges are ±3% of full-scale.

<sup>3</sup>Applies to settings 5 mV/div and above.

### Ordering Information

HP 54111D 2 gigasample/second digitizing oscilloscope

Opt W30 Extended repair service. See page 723.

### Price

\$28,900

+\$675

- 2 Giga-sample/second, one channel when used with HP 54114A
- 500 MHz repetitive bandwidth
- 8k memory depth
- HP PaintJet printer color output

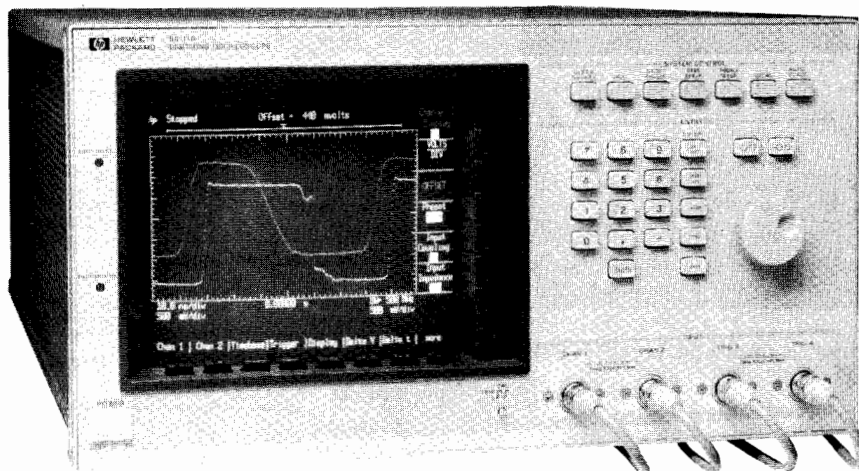

### HP 54111D: High-speed General-Purpose Scope

The HP 54111D can be configured as a 2 gigasample/second (G Sa/s), one channel oscilloscope or as a two channel 1 gigasample/second oscilloscope with a memory depth of 8k samples per channel. The HP 54111D retains all of the key features and user friendliness of the HP 54100/110 oscilloscopes, such as automatic measurements, autoscaling, cursors, and a color display. Plus, the HP 54111D adds features necessary for controlling and managing the added memory depth, such as scroll, zoom, and memory bar.

#### Key Contributions

- 2 gigasamples/second digitizing rate (maximum)
- 500 MHz bandwidth
- 8k memory per channel
- Up to eight bits of vertical resolution with bandwidth limits
- Two channels of simultaneous capture at up to 1 G Sa/s
- Pre-trigger information
- Automatic measurements
- Fully HP-IB programmable
- Advanced logic triggering capabilities
- Instant hard-copy output

#### Memory Bar Simplifies Data Viewing

The HP 54111D provides 8k samples of memory per channel. This results in a minimum of 16 screens of waveform information in single-shot acquisitions. To simplify management of all this data, the HP 54111D displays a memory bar. The memory bar is displayed along the top edge of the graticule and shows the portion of memory being viewed relative to the entire memory record. In addition, the trigger point is also shown along the memory bar.

#### General-purpose to Special Applications

With a 2 gigasample/second digitizing rate, the HP 54111D gives you the fastest sampling rate available in a general-purpose digitizing oscilloscope. However, the HP 54111D is much more than an instrument for capturing fast single-shot transients. With random repetitive sampling, this instrument provides a bandwidth of 500 MHz for high-speed circuit design and test.

In addition to its single-shot and repetitive capabilities, the HP 54111D provides flexible input coupling with a side dynamic range for viewing and analyzing a variety of signals. Use this scope for just about any general-purpose application from very slow to very high-speed repetitive or non-repetitive waveforms.

#### Ultra high digitizing rate

No longer do you need a manual analog storage oscilloscope to capture high-speed single-shot phenomena found in:

- high-speed pulse analysis
- nuclear test studies
- plasma discharge
- high voltage arcing
- high frequency bursts

All these single-shot events can be captured easily at 2 G Sa/s, with 4  $\mu$ s of data stored for review and analysis. (8  $\mu$ s over HPIB).

#### High-speed ECL design

Non-repetitive glitches appearing on the clock signal can be captured easily with the 500 MHz single-shot performance of the HP 54111D with the HP 54114A two-gigasample/second test set. Four  $\mu$ s of pre-trigger data is invaluable for determining the cause of the glitch.

#### High-speed semiconductor design

Single-shot performance of 500 MHz permits you to measure the outputs from latches (one-time events for multiple clock periods in ECL circuits).

#### Laser and high-energy research

Photo detector pulses can be measured with single-shot capture using the 2 GHz sampling rate and built-in automatic measurements. Infinite persistence can also be used to show and measure maximum variations of the waveform to the 500 MHz bandwidth.

The HP 54111D's two simultaneous 1 gigasample/second channels give you the single-shot performance of the most advanced analog storage oscilloscopes, but with all the advantages and ease of use of a digitizing oscilloscope. And with a staggered over-sampling technique, the HP 54111D provides this single-shot performance with up to eight bits of non-blooming vertical resolution.

# OSCILLOSCOPES & WAVEFORM ANALYZERS

## Digitizing Oscilloscopes

HP 54100A/D, 54110D

- 1 GHz bandwidth
- Auto pulse parameter and time interval measurements
- Digital storage
- Available with color or monochrome display
- Pre-trigger viewing
- Logic triggering capability

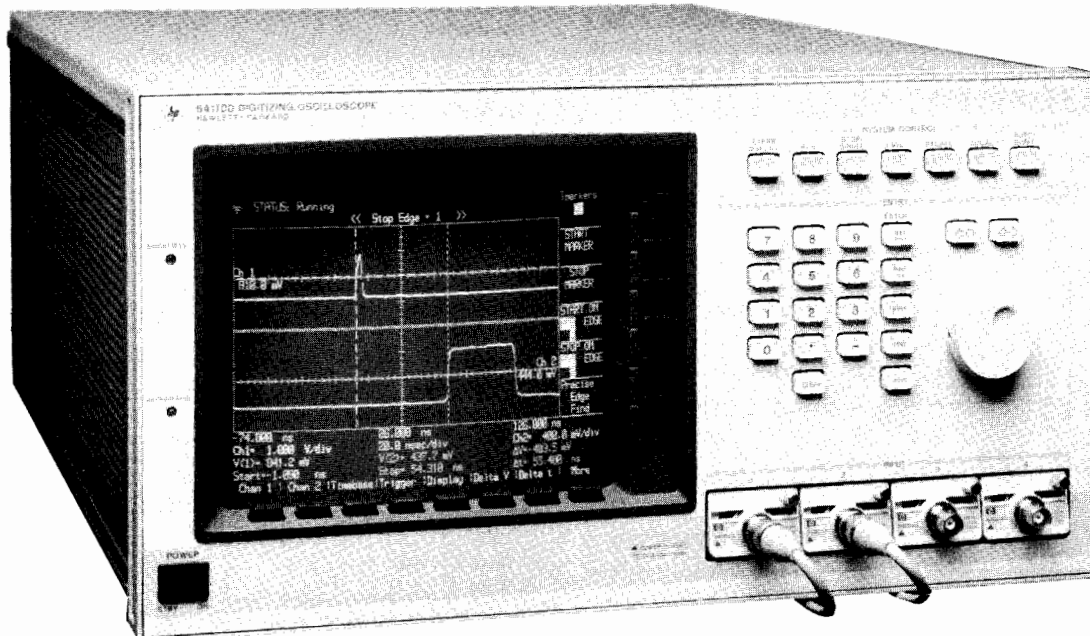

HP 54110D



### HP 54100A/D and HP 54110D Digitizing Oscilloscopes

As the speeds of analog and digital logic continue to increase, board and system designers need to pay even closer attention to high-frequency and transmission-line characteristics of their circuits. Design requirements are rigorous. Subnanosecond technology creates narrow and elusive pulses.

When a monochrome display is preferred, for example in a totally automatic test application, choose the HP 54100A or HP 54100D oscilloscope. These units require less rack height (7") than the HP 54110D (8.75") and have all of the same measurement features and specifications. The HP 54100A has one external trigger input, while the HP 54100D and HP 54110D have two.

#### High Bandwidth

The HP 54100 and 54110 unite a powerful 1 GHz bandwidth with a random repetitive sampling technique for viewing rarely occurring narrow waveforms. These oscilloscopes have 0.002% time base accuracy and 10 ps resolution for confident measurements of critical timing parameters in high-speed circuitry.

With random repetitive sampling, you can capture waveforms that occur thousands of screen diameters before the trigger event. This gives an effective memory depth of millions of bytes for finding causes of failures that occur long before the trigger.

#### High Resolution

Analyze perturbations within a waveform with high resolution. With vertical magnification and waveform averaging, small signal details can be viewed and measured with 10 bits of effective resolution.

#### Flexible Analysis

Only the HP 54100A/D and HP 54110D allow the display of either vertical channel versus the other. The 1 GHz bandwidth makes

this feature valuable in measuring high-speed I-V device characteristics and transfer functions high-speed converters.

#### A Choice of Input Pods and Probes

The HP 54100 and 54110 inputs are configured with removable pods that can be chosen according to the application. Pods can be changed quickly and easily, and they occupy a minimum of storage space.

- 50  $\Omega$  inputs and probes for a wide variety of environments, without the expense of amplifier plug-ins.
- 1-GHz miniature active probes for densely packed, high-speed logic circuits.
- 1 M $\Omega$  probes for circuits sensitive to resistive loading.
- 50  $\Omega$  BNC inputs for measurements where terminated lines are important.
- 100:1 probes for extended dynamic range.

For more information on the HP 54100/110 probing system, please refer to page 74.

#### Ordering Information

	<b>Price</b>
HP 54100A 1GHz digitizing oscilloscope	\$13,900
Opt W30 Extended repair service. See page 723.	+\$325
HP 54100D 1GHz digitizing oscilloscope	\$18,500
Opt W30 Extended repair service. See page 723.	+\$440
HP 54110D 1GHz digitizing oscilloscope	\$22,900
with color display	
Opt W30 Extended repair service. See page 723.	+\$550
<b>Input Pods and Probes</b>	
HP 54001A 1 GHz miniature active probe pod	\$765
HP 54002A 50 $\Omega$ BNC input pod	\$130
HP 54003A 1 M $\Omega$ 10:1 probe pod	\$665

### HP 54501A 100 MHz, 4 Channel Digitizing Oscilloscope

The HP 54501A is a 100 MHz, 4 channel digitizing oscilloscope designed primarily for repetitive signal applications. It has all of the digitizing advantages of oscilloscopes much higher in price. Ease of use and general purpose features such as TV trigger, dual-time-base windowing, advanced logic triggering, automatic measurements and full HP-IB programmability make it a powerful tool for both manual and automated test applications.

### HP 54501A Specifications and Characteristics

<b>Vertical (voltage)</b>	
<b>Bandwidth</b>	
dc-coupled:	
Repetitive	dc to 100 MHz (-3dB)
Single shot	dc to 1 MHz (Based on 10 points per period of input signal.)
ac-coupled:	
Repetitive	10 Hz to 100MHz (-3dB)
Single shot	10 Hz to 1 MHz (Based on 10 points per period of input signal.)
<b>Rise time:</b>	3.5 ns
calculated from:	$\text{Rise time} = \frac{0.35}{\text{bandwidth}}$
<b>Number of channels</b>	4 (2+2) (Channels 2 and 3 are limited attenuator inputs, optimized for digital signals.)
<b>Simultaneous channels</b>	2+2 Channels 1 and 4 are acquired simultaneously. If four channels are used, data is acquired alternately by channels 1 and 4, then 2 and 3.
<b>Vertical sensitivity range</b>	5 V/div to 5 mV/div
<b>Vertical gain accuracy (dc)</b>	± 1.5%
<b>Vertical resolution</b>	± 0.4% — 8 bit A/D (Since expansion is used for 5 mV/div range, A/D resolution is 7 bits 0.8% in that range.) ± 0.1% — 10 bits via HP-IB (with averaging)
<b>Maximum sample rate</b>	10 Megasamples/second
<b>Memory depth</b>	501 points (display) 1024 points (via HP-IB)
For single-shot via HP-IB, maximum memory depth is 501 points. For 2ns/div time base range, memory depth is 200 points. For 5ns/div time base range, maximum memory depth via HP-IB is 501 points.	
<b>Input RC (nominal)</b>	1 M Ω, 16 pF
<b>Input coupling</b>	ac, dc
<b>Max input voltage</b>	± 250 V [dc + peak ac (<10 kHz)]
<b>Offset range</b>	Sensitivity range      Available offset
	5 - 50 mV/div      ±2V
	0.1 - 1 V/div      ±20V
	1 - 5 V/div      ±200V
<b>Offset accuracy</b>	± 2% of offset ± 0.2 X (V/div) ± 0.075 division/Δ° C from calibration temperature
<b>Dynamic range</b>	± 16 divisions from center operating range for dc + peak ac input.
<b>Channel-to-channel isolation</b>	40 dB dc to 20 MHz 30 dB 20 MHz to 100 MHz (with channels at equal sensitivity)
<b>Voltage measurement accuracy</b>	
<b>Single cursor:</b>	gain accuracy + offset accuracy +A/D resolution
<b>Dual cursor:</b>	gain accuracy + (2 × A/D resolution) (single channel)

### Horizontal (time)

<b>Time base range</b>	2 ns/div to 5 s/div	
<b>Time base accuracy</b>	.005%	
<b>Maximum time base resolution</b>	100 ps	
<b>Delta-t Accuracy</b>	1 ns ± (5E-5) × delta t ± 0.02 × (t/div) Delta-t accuracy for dual-cursor, single-channel measurement, or for channel-to-channel measurement after visual time null calibration has been performed.	
<b>Delay range (post-trigger)</b>	Time base setting	Available delay
	50 ms - 5 s	40 x (s/div)
	100 μs - 20 ms	1 s
	2 ns - 50 μs	10,000 x (s/div)
<b>Delay range (pre-trigger)</b>	10 μs - 5 s	-40 x (s/div)
	20 ns - 5 μs	-200 μs
	2 ns - 10 ns	-10,000 x (s/div)
<b>Triggering</b>		
<b>Trigger sensitivity</b>		
5mV/div	dc-20MHz, 0.1 x full-scale 20MHz-100MHz, 0.25 x full-scale	
All Other	dc-20MHz, 0.05 x full-scale 20MHz-100MHz, 0.125 x full-scale	
<b>Trigger pulse width (minimum)</b>	7 ns	
<b>Trigger level range</b>	± 6 div from center	

Specifications valid for temperature range ± 10° C from calibration temperature with 8 averages selected and channel (s) in sensitivity range 1, 2 or 5.

**Power Requirements:** Voltage: 115/230 V ac,

-25% to +15% 48-66 Hz. Power 350 VA maximum

**Weight:** Net: approximately 10 kg (22 lb). Shipping: approximately 20 kg (44 lb).

**Size:** 194.3H x 422.3W x 355.6mmD (7.65" x 16.62" x 14")

Does not include front panel protrusions

### Ordering Information

The HP 54501A digitizing oscilloscope comes complete with two HP 10432A 10:1 10 MΩ probes, an operating and programming manual, a service manual, one miniature-probe-to-BNC male adapter, a power cord and a three-year warranty.

<b>HP 54501A</b> digitizing oscilloscope	qty 1	<b>Price</b> \$3,465
	qty ≥ 2 (each)	\$3,362
<b>Opt 908</b> Rackmount kit (5061-6175)		+ \$250
<b>Opt 910</b> One additional operating/programming manual (54501-90901) and one additional Service manual (54501-90902)		+ \$75
<b>Opt 090</b> delete probes		- \$200
☎ For same-day shipment, call HP DIRECT at 800-538-8787.		

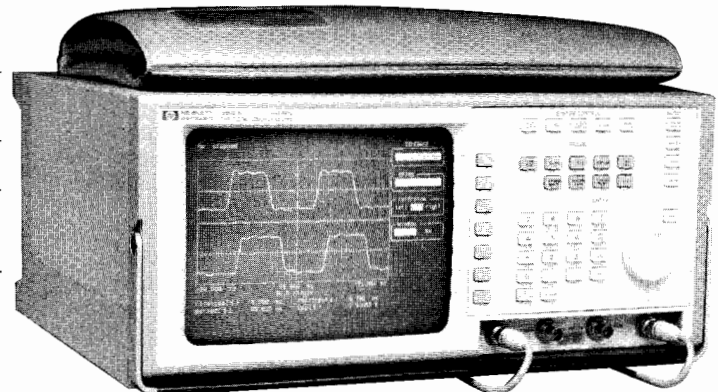

HP 54501A



# OSCILLOSCOPES & WAVEFORM ANALYZERS

## Digitizing Oscilloscopes

### HP 54502A 400 MHz, 400 MSa/s Digitizing

#### Oscilloscope

The HP 54502A is a 400 MHz, 400 MSa/s sample rate, 2-channel digitizing oscilloscope designed for both repetitive and single-shot signals. In repetitive mode, the HP 54502A has 400 MHz bandwidth. In real-time mode, its 400 MSa/s sample rate provides a single-shot bandwidth of 100 MHz. Like other members of the HP 54500 family, the HP 54502A has all of the digitizing advantages of oscilloscopes that are much higher in price. Its high repetitive/single-shot bandwidth, ease of use, HP-IB programmability, and HP 54500 family general-purpose features make it a powerful tool for both manual and automated test applications.

#### HP 54502A Specifications and Characteristics

	Real-time	Repetitive
<b>Bandwidth:</b> (-3 dB) dc-coupled	dc to 100 MHz	dc to 400 MHz <sup>1,5</sup>
<b>Switchable bandwidth limits</b>	ac-coupled lower -3 dB freq.: 90 Hz LF reject lower -3 dB freq.: 450 Hz Bandwidth limit: dc to 30 MHz	
<b>Rise time</b> <sup>2</sup>	3.5 ns	875 ps
<b>Number of channels</b>	2 (simultaneous)	
<b>Vertical sensitivity range</b>	2 mV/div to 5 V/div	
<b>Vertical gain accuracy (dc)</b> <sup>3,4</sup>	±2.0% of full scale	
<b>Vertical resolution</b> <sup>4</sup>	±1.6% of full scale (6 bit A/D) ±0.4% of full scale (8 bits with ≥8 averages)	
<b>Maximum sample rate</b>	400 MSa/s	25 MSa/s
<b>Waveform record length</b> <sup>6</sup>	normal: 501 points extended: 2001 points	time/div 5 ns - 5 s/div: 501 pts 2 ns/div: 401 pts 1 ns/div: 201 pts
<b>Input R (selectable)</b>	1 MΩ ±1% or 50Ω ±1%	
<b>Input C</b>	7 pF nominal	
<b>Input coupling</b>	ac, dc	
<b>Maximum input voltage</b>	1 MΩ: ±250 V [dc + peak ac (<10 kHz)] 50 Ω: 5 V rms	
<b>Offset range</b>	vertical sensitivity 2 mV - 50 mV/div >50 mV - 250 mV/div >250 mV - 1.25 V/div >1.25 V - 5 V/div	available offset ±2 V ±10 V ±50 V ±250 V
<b>Offset accuracy</b> <sup>4</sup>	±(2 mV+2% of ch. offset+2.5% of full scale)	
<b>Dynamic range</b>	±1.5 x full scale from center of screen	
<b>Channel-to-channel isolation</b>	40 dB: dc to 50 MHz 30 dB: 50 to 100 MHz (with channels at equal sensitivity)	40 dB: dc to 50 MHz 30 dB: 50 to 400 MHz
<b>Voltage measurement accuracy (dc)</b> <sup>3,4</sup>		
<b>Dual cursor</b>	±(2.0% of full scale + 0.032 x V/div)	
<b>Single cursor</b>	±(2.0% of full scale + offset accuracy + 0.016 x V/div)	
<b>Time base range</b>	1 ns/div to 5 s/div	
<b>Time base reference accuracy</b>	0.01%	
<b>Maximum time base resolution</b>	50 ps (maximum)	
<b>Delta-t accuracy</b>	±(2% x screen diameter + 0.01% x delta t + 500 ps)	±(2% x screen diameter + 0.01% x delta t + 250 ps)
<b>Delay range (post-trigger)</b>	Time/div setting 50 ms - 5 s/div 100 μs - 20 ms/div 1 ns - 50 μs/div	Available delay 40 x (s/div) 1s 10 000 x (s/div)

	Real-time	Repetitive	
<b>Delay range (pre-trigger)</b>	All time/div settings 40 x (s/div)	Time/div setting 1 μs-5/div 10 ns-500 ns/div 1 ns-5 ns/div	Available delay -40x(s/div) -80 μs -10 000x(s/div)

#### Triggering

##### Trigger sensitivity<sup>4</sup>

<b>Internal</b> dc to 100 MHz	0.5 div	0.5 div
100 MHz to 400 MHz	N/A	1 div
<b>External</b> dc - 250 MHz	100 mVp-p into 50 Ω	

##### Trigger pulse width (minimum)

<b>Internal</b>	7.0 ns	1.75 ns
<b>External</b>	2.8 ns	2.8 ns

##### Trigger level range

Internal: ±1.5 x full scale from center of screen  
External: ± 2V

**Power requirements:** Voltage: 115/230 V ac, -25% to +15%  
48-66 Hz. Power 350 VA maximum

**Weight:** Net: approximately 10 kg (22 lb). Shipping: approximately 20 kg (44 lb).

**Size:** 194.3H x 422.3W x 355.6mmD (7.65" x 16.62" x 14")

Does not include front panel protrusions

Specifications valid for temperature range ±10°C from software calibration temperature with eight or more averages selected.

<sup>1</sup>Upper bandwidth reduces by 2.5 MHz for each °C above +35°C.

<sup>2</sup>Rise times are calculated from:

$$t_r = \frac{0.35}{\text{bandwidth}}$$

<sup>3</sup>Vertical gain accuracy decreases 0.08% per °C from software calibration temperature.

<sup>4</sup>Expansion is used below 7 mV/div range so vertical resolution and accuracies are correspondingly reduced. Below 7mV/div full scale is defined as 56 mV.

<sup>5</sup>On time/div settings 1 μs/div and slower, bandwidth in repetitive mode is 100 MHz

<sup>6</sup>Available over HP-IB waveform record length is:

Real-time - normal:	500 points, extended: 2000 points
Repetitive 10 ns - 5 s/div:	1024 pts
-5 ns/div:	1000 pts
2 ns/div:	400 pts
1 ns/div:	200 pts

### HP 54502A Telecommunications Mask Template Test Option

Make telecom mask template measurements to ANSI, CCITT, and ISDN standards without using Mylar overlays. HP 54502A option 001 automates many of the mask measurements that are time consuming with analog oscilloscopes. Pass-fail accuracy and repeatability are improved through use of automatic measurements eliminating human error.

#### HP 54502A Option 001 Features

- 15 standard telecom signal mask templates stored in ROM
- Positive and negative templates
- Automatic triggering on positive "isolated ones"<sup>1</sup> in live traffic for many standard telecom signals
- Automatic best-fit of test signals to positive mask templates
- Automatic pass-fail comparison of mask templates with corresponding input signals
- Automatic storage, printing or plotting of failed signals
- User-defined pass-fail tolerance
- Memory protection for user mask templates, waveforms and front panel setups

For more information on this option and a technical data sheet, contact your local HP Sales Office (see page 737).

<sup>1</sup>For the HP 54502A Opt. 001, the term "isolated ones" is defined as a pulse sequence of at least two zeros followed by a one followed by at least two zeros.

#### Ordering Information

The HP 54502A digitizing oscilloscope comes complete with two HP 10430A 10:1 10 MΩ probes, a front panel manual, a programming manual, a service manual, a miniature probe to BNC male adapter, a power cord, and three-year warranty.

HP 54502A digitizing oscilloscope	qty 1	Price
	qty ≥ 2 (each)	
Opt 001 telecommunications mask template test option		\$6,450
Opt 908 rackmount kit (5061-6175)		\$6,257
Opt 910 additional front-panel, programming and service manual		+\$500
Opt 090 delete probes		+\$250
☎ For same-day shipment, call HP DIRECT at 800-538-8787		+\$75
		-\$200

## HP 54503A 500 MHz 4 Channel Digitizing Oscilloscope

The HP 54503A is a 500 MHz, 4 channel digitizing oscilloscope designed primarily for repetitive signal applications. All four channels have full-featured attenuators. Like all of the HP 54500 family oscilloscopes, the 54503A features 2-channel simultaneous sampling and has the digitizing advantages of oscilloscopes much higher in price. Its four channels, 500 MHz repetitive signal bandwidth, ease of use, HP-IB programmability, and HP 54500 family general-purpose features make it a powerful tool for both manual and automated test applications.

### HP 54503A Specifications and Characteristics

<b>Vertical (voltage)</b>	
<b>Bandwidth</b> (-3 dB) dc-coupled	
repetitive <sup>1</sup>	dc to 500 MHz
single-shot	dc to 2 MHz (based on 10 points per period of input signal)
<b>Switchable bandwidth limits</b>	ac-coupled lower -3 dB frequency : 90 Hz LF reject lower -3 dB frequency : 450 Hz Bandwidth limit upper -3 dB frequency : 30 MHz
<b>Rise time</b>	700 ps (calculated from: rise time = 0.35/BW)
<b>Number of channels<sup>2</sup></b>	4
<b>Vertical sensitivity range</b> (all channels)	1 mV/div to 5 V/div
<b>Vertical gain accuracy dc:</b> <sup>3,4</sup>	±1.25%
<b>Vertical resolution<sup>4</sup></b>	± 0.4% (8 bit A/D) ± 0.1% (10 bits via HP-IB with averaging)
<b>Maximum sample rate</b>	20 MSa/s
<b>Waveform record length<sup>5</sup></b>	501 points (display) 1024 points (via HP-IB)
<b>Input R</b> (selectable)	1 MΩ ± 1% or 50 Ω ± 1%
<b>Input C</b>	7pF nominal
<b>Input coupling</b>	ac, dc
<b>Maximum input voltage</b>	1MΩ: ± 250V [dc + peak ac <10 kHz] 50 Ω: 5V rms
<b>Offset range</b>	Vertical sensitivity Available offset 1mV to 50 mV/div ± 2V > 50 mV to 250 mV/div ± 10V > 250 mV to 1.25 V/div ± 50V > 1.25 V to 5 V/div ± 250V
<b>Offset accuracy<sup>4</sup></b>	± (2% of full scale + 0.5% of offset)
<b>Dynamic range</b>	(dc + peak ac) ± 1.5 X full scale from center of screen
<b>Channel-to-channel isolation</b>	40 dB: dc to 100 MHz 30 dB: 100 MHz to 500 MHz (with channels at equal sensitivity)
<b>Voltage measurement accuracy</b>	
Dual cursor <sup>3,4</sup>	± (1.25% of full scale + 0.032 div)
Single cursor	± (1.25% of full scale + offset accuracy + 0.016 div)

### Horizontal (time)

<b>Time base range</b>	200 ps/div to 5 s/div	
<b>Time base reference accuracy</b>	0.005%	
<b>Maximum time base resolution</b>	20 ps	
<b>Delta t accuracy</b>	± 2% of s/div ± 0.005% X delta t ± 100 ps	
<b>Delay range</b> (post-trigger)	Time/div setting Available delay 50 ms - 5 s/div 40 X (s/div) 100µ- 20 ms/div 1 s 200 ps - 50 µs/div 10,000 X (s/div)	
<b>Delay range</b> (pretrigger)	5µs- 5s -39.96 X (s/div) 10 ns - 2µs -99.9 µs 200 ps - 5 ns -10,000 X (s/div)	

### Triggering

<b>Trigger sensitivity</b>		
≥ 5 mV/div	dc-100MHz 0.063 of full-scale 100 MHz-500 MHz 0.156 of full scale	
< 5 mV/div	dc-100 MHz 2.5 mV 100 MHz-500 MHz 6 mV	
<b>Trigger pulse width</b> (minimum)	1.5 ns	
<b>Trigger level range</b>	± 1.5 X full scale from center of screen	

**Power Requirements:** Voltage: 115/230 V ac, -25% to +15% 48-66 Hz. Power 350 VA maximum  
**Weight:** Net: approximately 10 kg (22 lb). Shipping: approximately 20 kg (44 lb).  
**Size:** 194.3H x 422.3W x 355.6mmD (7.65" x 16.62" x 14")  
 Does not include front panel protrusions

Specifications valid for temperature range ± 10°C from software calibration temperature with 8 averages selected and channel(s) in sensitivity range 1, 2 or 5.

<sup>1</sup>Upper bandwidth reduces by 2.5 MHz for each degree centigrade above +35°C.

<sup>2</sup>Simultaneous acquisition on two channels. Channels 1 and 4 are acquired simultaneously. If four channels are used, data is acquired alternately by channels 1 and 4, then 2 and 3.

<sup>3</sup>Accuracy reduces by ±0.08% for each degree centigrade away from software calibration temperature.

<sup>4</sup>Expansion is used below 7 mV/div range so vertical resolution and accuracies are correspondingly reduced.

<sup>5</sup>For single-shot via HP-IB, waveform record length is 500 points. In repetitive mode: 200 ps/div time base range, waveform record length is 100 points. 500 ps/div time base range, waveform record length is 250 points. 1 ns/div time base range, waveform record length is 500 points. ≥ 2 ns/div time base range, waveform record length is 1000 points.

### Ordering Information

The HP 54503A digitizing oscilloscope comes complete with two HP 10430A 10:1 10 MΩ probes, a front-panel manual, a programming manual, a service manual, a miniature probe to BNC male adapter, a power cord, and three-year warranty.

	qty 1	Price
HP 54503A digitizing oscilloscope	qty ≥ 2 (each)	\$5,450
Opt 908 rackmount kit (5061-6175)		\$5,287
Opt 910 additional front-panel, programming and service manual (54503-90901, 54503-90902)		+\$250
Opt 090 delete probes		+\$75
☎ For same-day shipment call HP DIRECT at 800-538-8787.		-\$200

# OSCILLOSCOPES & WAVEFORM ANALYZERS

## Digitizing Oscilloscopes

HP 54504A

### HP 54504A 400 MHz, 200 MSa/s Digitizing Oscilloscope with 8-bit Vertical Resolution

The HP 54504A is a 400 MHz, 200 MSa/s sample rate, 2-channel digitizing oscilloscope with 8 bit A/Ds designed for both repetitive and single-shot signals. In repetitive mode, the HP 54504A has 400 MHz bandwidth. In real-time mode, its 200 MSa/s sample rate provides a single-shot bandwidth of 50 MHz. Like other members of the HP 54500 family, the HP 54504A has all of the digitizing advantages of oscilloscopes that are much higher in price. Its high repetitive/single-shot bandwidth, ease of use, HP-IB programmability, and HP 54500 family general-purpose features make it a powerful tool for both manual and automated test applications.

### HP 54504A Specifications and Characteristics

	Real-time	Repetitive
<b>Bandwidth:</b> (-3 dB) dc-coupled	dc to 50 MHz	dc to 400 MHz <sup>1,5</sup>
<b>Switchable bandwidth limits</b>	ac-coupled lower -3 dB freq.: 90 Hz LF reject lower -3 dB freq.: 450 Hz Bandwidth limit: dc to 30 MHz	
<b>Rise time</b> <sup>2</sup>	7.0 ns	875 ps
<b>Number of channels</b>	2 (simultaneous)	
<b>Vertical sensitivity range</b>	1 mV/div to 5 V/div	
<b>Vertical gain accuracy (dc)</b> <sup>3,4</sup>	±1.50% of full scale	
<b>Vertical resolution</b> <sup>4</sup>	±0.4% of full scale (8 bit A/D) ±0.1% of full scale (10 bits with ≥ 8 averages)	
<b>Maximum sample rate</b>	200 MSa/s	25 MSa/s
<b>Waveform record length</b> <sup>6</sup>	normal: 501 points extended: 2001 points	time/div 5 ns - 5 s/div 2 ns/div 1 ns/div
<b>Input R</b> (selectable)	1 MΩ ±1% or 50Ω ±1%	
<b>Input C</b>	7 pF nominal	
<b>Input coupling</b>	ac, dc	
<b>Maximum input voltage</b>	1 MΩ: ±250 V [dc + peak ac (<10 kHz)] 50 Ω: 5 V rms	
<b>Offset range</b>	vertical sensitivity 1 mV - 50 mV/div >50 mV - 250 mV/div >250 mV - 1.25 V/div >1.25 V - 5 V/div	available offset ±2 V ±10 V ±50 V ±250 V
<b>Offset accuracy</b> <sup>4</sup>	±(+1.0% of ch. offset+2% of full scale)	
<b>Dynamic range</b>	±1.5 x full scale from center of screen	
<b>Channel-to-channel isolation</b> (with channels at equal sensitivity)	40 dB: dc to 50 MHz N/A: 50 to 400 MHz	40 dB: dc to 50 MHz 30 dB: 50 to 400 MHz
<b>Voltage measurement accuracy (dc)</b> <sup>3,4</sup>	Dual cursor ±(1.5% of full scale + 0.032 x V/div) Single cursor ±(1.5% of full scale + offset accuracy + 0.016 x V/div)	

	Real-time	Repetitive
<b>Time base range</b>	1 ns/div to 5 s/div	
<b>Time base reference accuracy</b>	0.01%	
<b>Maximum time base resolution</b>	50 ps	
<b>Delta-t accuracy</b>	±(2% x s/div + 0.01% x delta t + 1 ns)	±(2% x s/div + 0.01% x delta t + 250 ps)
<b>Delay range</b> (post-trigger)	Time/div setting 50 ms - 5 s/div 100 μs - 20 ms/div 1 ns - 50 μs/div	Available delay 40 x (s/div) 1s 10 000 x (s/div)
<b>Delay range</b> (pre-trigger)	All time/div settings 40 x (s/div)	Available delay 1 μs-5 s/div 10 ns-500 ns/div 1 ns-5 ns/div

### Triggering

#### Trigger sensitivity<sup>4</sup>

<b>Internal</b>		
dc to 50 MHz	0.5 div	0.5 div
50 MHz to 100 MHz	not applicable	0.5 div
100 MHz to 400 MHz	not applicable	1.0 div
<b>External</b>		
dc - 250 MHz	100 mVp-p into 50 Ω	

#### Trigger pulse width (minimum)

Internal	14.0 ns	1.75 ns
External	2.8 ns	2.8 ns

#### Trigger level range

Internal: ±1.5 x full scale from center of screen  
External: ± 2V

**Power requirements:** Voltage: 115/230 V ac, -25% to +15% 48-66 Hz. Power 350 VA maximum

**Weight:** Net: approximately 10 kg (22 lb). Shipping: approximately 20 kg (44 lb).

**Size:** 194.3H x 422.3W x 355.6mmD (7.65" x 16.62" x 14") Does not include front panel protrusions

Specifications valid for temperature range ±10°C from software calibration temperature with eight or more averages selected.

<sup>1</sup>Upper bandwidth reduces by 2.5 MHz for each °C above +35°C.

<sup>2</sup>Rise times are calculated from:

$$t_r = \frac{0.35}{\text{bandwidth}}$$

<sup>3</sup>Vertical gain accuracy decreases 0.08% per °C from software calibration temperature.

<sup>4</sup>Expansion is used below 7 mV/div range so vertical resolution and accuracies are correspondingly reduced. Below 7 mV/div full scale is defined as 56 mV.

<sup>5</sup>On time/div settings 1 μs/div and slower, bandwidth in repetitive mode is 50 MHz.

<sup>6</sup>Available over HP-IB waveform record length is:

Real-time -normal:	500 points, extended: 2000 points
Repetitive	10 ns - 5 s/div: 1024 pts -5 ns/div: 1000 pts 2 ns/div: 400 pts 1 ns/div: 200 pts

### Ordering Information

The HP 54504A digitizing oscilloscope comes complete with two HP 10430A 10:1 10 MΩ probes, a front panel manual, a programming manual, a service manual, a miniature probe to BNC male adapter, a power cord, and three-year warranty.

	Price
HP 54504A digitizing oscilloscope	qty 1 \$6450 qty ≥ 2 (each) \$6257
Opt 908 rackmount kit (5061-6175)	+\$250
Opt 910 additional front-panel, programming and service manual (54504-90901, 54504-90902)	+\$75
Opt 090 delete probes	-\$200
☎ For same-day shipment, call HP DIRECT at 800-538-8787.	

### HP 54510A: 1 GSa/s Digitizing Oscilloscope

The HP 54510A is a 1 gigasamples/second, two-channel, portable digitizing oscilloscope with a memory depth of 8k samples per channel. The HP 54510A retains all of the key features and user friendliness of other 54500 series oscilloscopes. The HP 54510A adds waveform calculus, memory bar for pan and zoom, faster update rate, and faster throughput over HP-IB. The HP 54510A is an affordable high-performance oscilloscope for applications such as advanced hardware design and troubleshooting, high-energy research, and manufacturing test/ATE.

### HP 54510A Specifications and Characteristics

#### Vertical (voltage)

<b>Bandwidth:</b> dc-coupled <sup>1</sup>	dc to 250 MHz (-3 dB) (300 MHz repetitive mode typical)	
<b>Switchable bandwidth limits</b>	ac-coupled lower -3 dB frequency: 90 Hz LF reject lower -3 dB frequency: 450 Hz Bandwidth limit -3 dB frequency: 30 MHz	
<b>Rise time<sup>2</sup></b>	1.4 ns	
<b>Number of channels</b>	2 (simultaneous)	
<b>Vertical sensitivity range</b>	1 mV/div to 5 V/div	
<b>Vertical gain Accuracy<sup>3, 4</sup></b>	± 1.25% of full scale	
<b>Vertical resolution<sup>4</sup></b>	8 bits over eight divisions (± 0.4%) 10 bits w/averaging (± 0.1%)	
<b>Maximum sample rate</b>	1 GSa/s	
<b>Waveform record length<sup>5</sup></b>	8001 points (real-time) 501 points (repetitive)	
<b>Input R (selectable)</b>	1 MΩ ± 1% or 50 Ω ± 1%	
<b>Input C</b>	7 pF nominal	
<b>Input coupling</b>	ac, dc	
<b>Maximum input voltage</b>	1 MΩ: ± 250 V [dc + peak ac (< 10 kHz)] 50 Ω: 5 V rms	
<b>Offset range</b>	<b>vertical sensitivity</b>	<b>available offset</b>
	1 mV - 50 mV/div	± 2 V
	>50 mV - 250 mV/div	± 10 V
	>250 mV - 1.25 V/div	± 50 V
	>1.25 V - 5 V/div	± 250 V
<b>Offset accuracy<sup>4</sup></b>	±(1.0% of ch. offset + 2% of full scale)	
<b>Dynamic range</b>	± 1.5 x full scale from center of screen	
<b>Channel-to-channel isolation</b>	40 dB: dc to 50 MHz 30 dB: 50 MHz to 250 MHz	
<b>Voltage measurement accuracy<sup>3, 4</sup></b>		
<b>Dual cursor</b>	±(1.25% of full scale + 0.032 x V/div)	
<b>Single cursor</b>	±(1.25% of full scale + offset accuracy + 0.016 x V/div)	

#### Horizontal (time)

<b>Time base range</b>	1 ns/div to 5 s/div	
<b>Maximum time base resolution</b>	20 ps	
<b>Delta-t accuracy<sup>6</sup></b>		
Repetitive	±(0.005% x delta t + 2E-6 x delay setting + 100 ps)	
Real-time (single acquisition)	±(0.005% x delta t + 2E-6 x delay setting + 150 ps)	
<b>Delay range (post-trigger)</b>	10 000 x (s/div)	
<b>Delay range (pre-trigger)</b>	Time/div setting	Available delay
	100 ns - 5 s/div	-160 x (s/div)
	1 ns - 50 ns/div	-8 μs

#### Triggering

##### Trigger sensitivity<sup>4</sup>

<b>Internal</b>		
dc to 50 MHz	0.5 div	
50 MHz to 250 MHz	1.0 div	
<b>External</b>		
dc to 250 MHz	100 mVp-p into 50 Ω	
<b>Trigger pulse width (minimum)</b>		
Internal	1.75 ns	
External	2.8 ns	

##### Trigger level range

Internal: ± 1.5 x full scale from center screen  
External: ± 2 V

Specifications valid for temperature range ±10 degrees C from software calibration temperature with eight or more averages selected.

<sup>1</sup> Upper bandwidth reduces by 2.5 MHz for each degree C above 35 degrees C.

<sup>2</sup> Rise times are calculated from  $t_r = \frac{0.35}{\text{bandwidth}}$

<sup>3</sup> Vertical gain accuracy decreases 0.08% per °C from software calibration temperature.

<sup>4</sup> Expansion is used below 7 mV/div range, so resolution and accuracies are correspondingly reduced. Below 7 mV/div full scale is defined as 56 mV.

<sup>5</sup> Available over HP-IB waveform record length is:

Realtime - 8000 points  
Repetitive - 500 points

<sup>6</sup> Specification applies at the maximum sampling rate. At lower sampling rates specification should read ±(0.005% x delta t + 2E-6 x delay setting + 0.15 x sample interval) For bandwidth limited signals  $t_r = 1.4 \times \text{sample interval}$ . Sample interval is defined as 1/sample rate. Specification also applies to those automatic measurements computing time intervals on similar slope edges (i.e. pos-pos, neg-neg).

#### Ordering Information

The HP 54510A digitizing oscilloscope comes with two HP 10430A 10:1 10 MΩ probes, a front panel manual, a programming manual, a service manual, a miniature probe to BNC male adapter, a power cord, and a three-year warranty.

	Price
HP 54510A 1 GSa/s digitizing oscilloscope	\$10,950
Opt 908 rackmount kit (5061-6175)	+\$250
Opt 910 additional front panel, programming and service manuals	+\$75
Opt 090 delete probes	-\$200

# OSCILLOSCOPES & WAVEFORM ANALYZERS

## Digitizing Oscilloscopes

HP 54501A, 54502A, 54503A, 54504A, 54510A

- Choice of 100 MHz, 250 MHz, 400 MHz, 500 MHz bandwidth
- Single-shot and repetitive signal performance
- Up to 4 channels
- Fully programmable
- Automatic pulse parameter measurements
- Dual-time-base windowing (except HP 54510A)
- Pan and zoom (HP 54510A)
- Automatic limit testing
- Three-year warranty
- Affordable

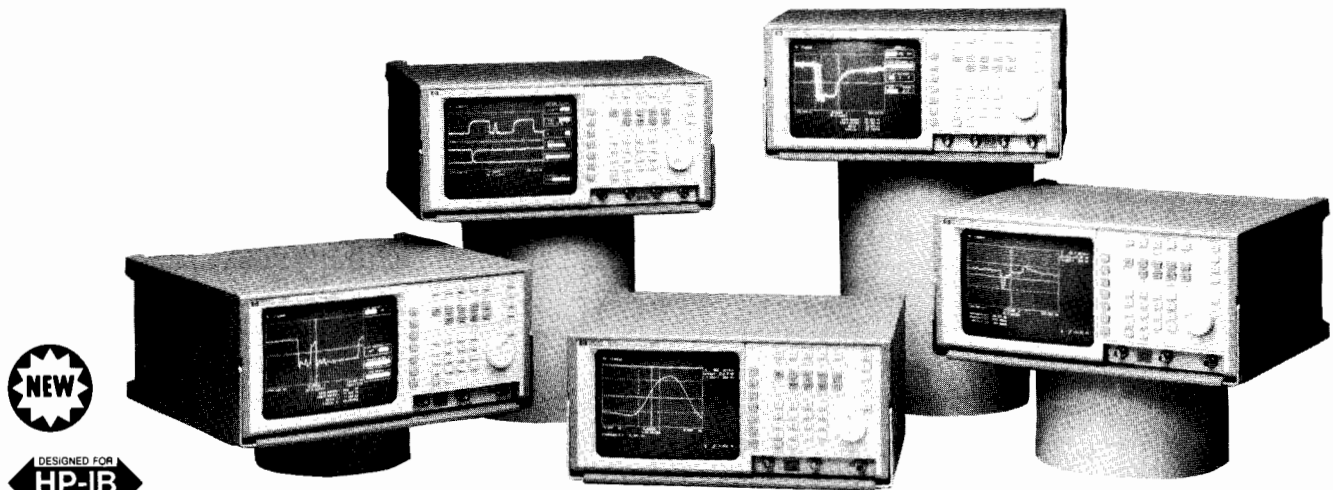

HP 54501A, 54502A, 54503A  
54504A, 54510A

### The HP 54500 Family of Digitizing Oscilloscopes

#### A Family of Affordable Digitizing Oscilloscopes

There are five models in the HP 54500 family of digitizing oscilloscopes. For repetitive signals, the HP 54501A and 54503A offer 100 MHz and 500 MHz, respectively, and four-channel, general-purpose performance. When single-shot capability is important, the HP 54502A and 54504A provide respectively 100 MHz and 50 MHz single-shot; and they both provide 400 MHz repetitive signal bandwidths. Using custom ADC design and other custom integrated circuits, the new HP 54510A boosts single-shot performance to 250 MHz by introducing the first 1 Gigasample-per-second portable oscilloscope. All members of this family deliver surprising performance at an affordable price.

#### The Digitizing Advantage

The HP 54500 family of oscilloscopes has features and functions that were previously available only on considerably higher-priced instruments. Like the HP 54100 series digitizing oscilloscopes, these instruments include all of the digitizing advantages, such as autoscale, pushbutton hard-copy output, automatic measurements, non-volatile setup and waveform memories, and full HP-IB programmability.

#### Affordable Automation

The HP 54500 family's fully programmable setup and data acquisition capabilities can be used with your HP Vectra PC, IBM PC, or other compatible personal computer. The built-in HP-IB interface, simplified, self-documenting programming language, and high data throughput rate provide a modestly priced, yet powerful automated test system.

#### Easy-to-Use

All members of the HP 54500 family have a new simplified user interface that makes them the easiest to operate of any HP oscilloscopes. Adjustments are made with a single front-panel knob or numeric keypad. Automatic measurements, hard-copy output, or instrument setup are performed with simple keystrokes. Operation is intuitive and straightforward.

#### Advanced Logic and TV Triggering

Hewlett-Packard's advanced logic triggering is a standard feature in the HP 54500 family. Use it to trigger on a wide variety of user-specified conditions. Trigger on edge, pattern, state, or trigger-after-delay to capture such elusive events as timing violations or transient bus phenomena.

Select line and field for a variety of video waveforms. The 54500 family makes it easy to focus on the video information that you need to capture.

#### Measurement Limit Test

Using measurement limit test, the HP 54500 family can automatically characterize a circuit or device over temperature or time—without human supervision. Specify upper and lower limits for any three of the instrument's automatic measurements, and leave it running unattended. If a measurement exceeds predefined limits, the violating waveform, measurements and other display data can be automatically stored or transferred to an external printer or controller.

These instruments can automatically calculate maximum, minimum, average, and most-recent values for all measurements, making device or circuit characterization even more accurate.

#### Dual-time-base Windowing<sup>1</sup>

Dual-time-base windowing lets you zoom in on fine details of the waveform that you are measuring. Similar to the dual-delayed sweep feature found on some analog oscilloscopes, dual-time-base windowing gives you a time-expanded view of a smaller portion of the waveform that is defined by you with the instrument's easy-to-use cursors.

#### Lightweight and Portable

Members of the HP 54500 family weigh only 22 pounds and are easily transported. Their small size allows them to fit easily in the trunk of a car, making them ideal for field applications. An optional soft carrying case is also available, as well as a sturdy transit case for safe shipment. See page 76 for accessories.

<sup>1</sup>The HP 54510A has "Pan & Zoom" in place of this feature see page 59.

**Compare the Features . . .**

Whether you need pinpoint vertical resolution or lightning-fast signal capture, Hewlett-Packard's digitizing oscilloscopes provide a powerful set of features and capabilities in an easy-to-use interface.

Here's a look at how the various models compare in terms of features, capabilities, and price.

Model	HP 54501A	HP 54502A	HP 54503A	HP 54504A	HP 54510A	HP 16500A Mainframe with 16530A/16531A
<b>Bandwidth</b> -Repetitive -Single-shot	100 MHz 1 MHz <sup>2</sup>	400 MHz 100 MHz	500 MHz 2 MHz	400 MHz 50 MHz	250 MHz 250 MHz	100 MHz 100 MHz
<b>Time interval accuracy</b> -Repetitive -Single-shot	1 ns 1 ns	250 ps 500 ps	100 ps 100 ps	250 ps 1 ns	100 ps 150 ps	1 ns 1 ns
<b>Channels</b>	4 (2+2)	2	4	2	2	2 - 8
<b>Digitizing rate</b>	10 MSa/s	400 MSa/s	20 MSa/s	200 MSa/s	1 GSa/s	400 MSa/s
<b>Memory/channel</b>	500 samples 1 k samples (HP-IB)	501 samples 2 k samples (extended)	501 samples 1 k samples (HP-IB)	501 samples 2 k samples (extended)	8 k samples	4 K samples
<b>Vertical resolution</b>	8 bits, 10 bits with averaging	6 bits, 8 bits with averaging	8 bits, 10 bits with averaging	8 bits, 10 bits with averaging	8 bits, 10 bits with averaging	6 bits, 8 bits with averaging
<b>Input voltage ranges</b>	continuously variable 40 mV-40 V full scale	continuously variable 16 mV-40 V full scale	continuously variable 8 mV-40 V full scale	continuously variable 8 mV-40 V full scale	8 mV-40 V	continuously variable 40 mV-16 V full scale
<b>Input coupling</b>	1M $\Omega$ , 50 $\Omega$ ac, dc, internal	1M $\Omega$ , 50 $\Omega$ ac, dc, internal	1M $\Omega$ , 50 $\Omega$ ac, dc, internal	1 M $\Omega$ , 50 $\Omega$ ac, dc, internal	1 M $\Omega$ , 50 $\Omega$ ac, dc, internal	1M $\Omega$ , 50 $\Omega$ ac, dc, internal
<b>Pulse parameter measurements</b>	yes	yes	yes	yes	yes	yes
<b>Waveform math</b>	A+B, A-B, AXB, A vs B, invert, only	A+B, A-B, AXB, A vs B, invert, only	A+B, A-B AXB, A vs B, invert, only	A+B, A-B, AXB, A vs B, invert, only	A+B, A-B, AXB, A vs B, integrate, differentiate invert, only	A+B, A-B
<b>Other analysis functions</b>	variable and infinite persistence, averaging, envelope	variable and infinite persistence, averaging, envelope	variable and infinite persistence, averaging, envelope	variable, infinite persistence, averaging, envelope	variable and infinite persistence, averaging, envelope	infinite persistence, averaging
<b>Waveform storage</b>	2 pixel, 4 waveforms	2 pixel, 4 waveforms	2 pixel, 4 waveforms	2 pixel, 4 waveforms	2 pixel, 4 waveforms	store to built-in disk
<b>Trigger enhancements</b>	glitch, edge, pattern, state, digital delay by event and time, time-qualified pattern, TV	glitch, edge, pattern, state, digital delay by event and time, time-qualified pattern, TV	glitch, edge, pattern, state, digital delay by event and time, time-qualified pattern, TV	glitch, edge, pattern, delay by event and time, time-qualified pattern, TV	glitch, edge, pattern, delay by event and time, time-qualified pattern, TV	edge, pattern, delay by event, immediate
<b>Instant hardcopy &amp; disk support</b>	HP graphic printers	HP graphic printers, plotters	HP graphic printers, plotters	HP graphic printers, plotters	HP graphic printers, plotters	HP printers HP PaintJet printer 2 built-in disk drives
<b>Other</b>	measurement statistics and limit test, dual time base windowing, scroll mode	measurement statistics and limit test, dual time base windowing, scroll mode	measurement statistics and limit test, dual time base windowing, scroll mode	measurement statistics and limit test	measurement statistics and limit test, segmentable memory via HP-IB, post-acquisition pan and zoom	logic analysis, high-speed timing, pattern generation, dual time base (optional)
<b>For more information, order publication number</b>	HP 5954-2679(D)	HP 5952-0862(D)	HP 5959-8795(D)	HP 5952-0862(D)	HP 5952-2404(D)	HP 5954-2656(D)
<b>Page Reference</b>	63	62	61	60	59	270
<b>Price</b>	\$3,465	\$6,450	\$5,450	\$6,450	\$10,950	\$13,050 to \$25,350

# OSCILLOSCOPES & WAVEFORM ANALYZERS

## HP Digitizing Oscilloscopes (cont'd)

Model	HP 54100A/D & HP 54110D	HP 54111D (with HP 54114A)	HP 54112D	HP 54121T	HP 54123T	HP 54124T	HP 54122T
<b>Bandwidth</b> -Repetitive -Single-shot	1 GHz 4 MHz <sup>2</sup>	500 MHz 500 MHz	100 MHz 100 MHz	20 GHz not applicable	34 GHz not applicable	50 GHz not applicable	12.4 GHz not applicable
<b>Time interval accuracy</b> -Repetitive -Single-shot	100 ps 300 ps	100 ps 300 ps	300 ps 300 ps	10 ps not applicable			10 ps not applicable
<b>Channels</b>	2	2	4	4			4
<b>Digitizing rate</b>	40 MSa/s	1 GSa/s	400MSa/s	not applicable			not applicable
<b>Memory/channel</b>	1K samples	8K samples	64K samples	501 samples			501 samples
<b>Vertical resolution</b>	7 bits, 10 bits with averaging	8 bits to 50 MHz 7 bits to 200MHz 6 bits to 410 MHz	6 bits	12 bits, 14 bits with averaging			12 bits, 14 bits with averaging
<b>Input voltage ranges</b>	7 ranges 80 mV-8 V full scale	continuously variable 8 mV-40 V full scale	continuously variable 40 mV-40 V full scale	continuously variable 1 mV-80 mV per division			continuously variable 1 mV-2.4 V per division
<b>Input coupling</b>	50 $\Omega$ , 10k $\Omega$ 1M pods	50 $\Omega$ , 1M $\Omega$ ac,dc, internal	50 $\Omega$ , 1M $\Omega$ 50,1M ac,dc, internal	50 $\Omega$			50 $\Omega$
<b>Pulse parameter measurements</b>	yes	yes	yes	yes			yes
<b>Waveform math</b>	A+B, A-B, A vs B, invert	A+B, A-B, invert	A+B, A-B, invert	A+B, A-B, A vs B, min, max, invert, only			A+B, A-B, A vs B, min, max invert, only
<b>Other analysis functions</b>	variable and infinite persistence, averaging, magnify	variable and infinite persistence, averaging	variable and infinite persistence, averaging	variable and infinite persistence, averaging			variable and infinite persistence, averaging
<b>Waveform storage</b>	2 pixel, 4 waveforms	2 pixel 4 repetitive, 4 single-shot waveforms	2 pixel 4 repetitive 4 single-shot waveforms	2 pixel 4 waveforms			2 pixel 4 waveforms
<b>Trigger enhancements</b>	<sup>1</sup> Edge, pattern, state, digital delay by event and time, time-qualified pattern	edge, pattern, state, digital delay by event and time, time-qualified pattern	edge, pattern, state, digital delay by event and time	2.5 GHz edge trigger to 18 GHz with HP 54118A			2.5 GHz edge trigger to 18 GHz with HP 54118A
<b>Instant hard copy &amp; disk support</b>	HP printers and HP plotters			HP graphic printers, plotters including PaintJet			HP graphic printers, plotters including PaintJet
<b>Other</b>	color <sup>3</sup> display & color hard copy	color display & color hard copy		built-in histograms TDR / TDT			built-in histograms color display & color hard copy
<b>For more information, order publication number</b>	HP 5954-2659 (D)			HP 5952-7084(D)		HP 5952-7084(D) HP 5952-1171(D)	HP 5952-7084(D)
<b>Page reference</b>	64	66	67	68	68	68	68
<b>Price</b>	\$13,900 \$18,500 \$22,900	\$28,900	\$22,900	\$28,800	\$34,800	\$42,800	\$28,800

<sup>1</sup>D models only<sup>2</sup>10 points per period without reconstruction<sup>3</sup>HP 54110D only

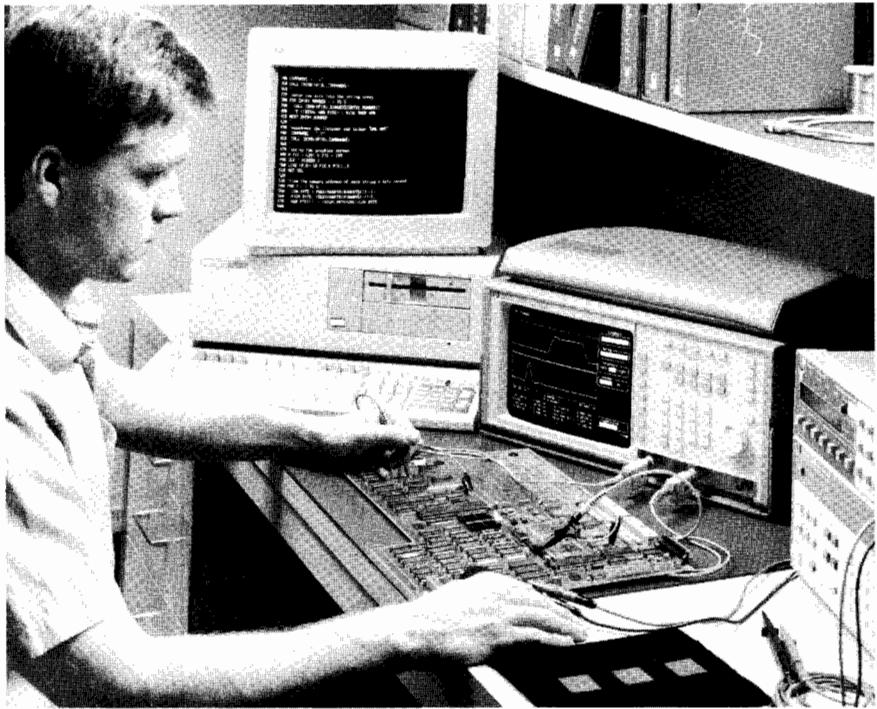

**Digital Storage**

- Bright, stable display of low-duty-cycle signals.
- Retain waveforms as long as desired for worst-case analysis.
- Fade-free, non-blooming display.
- Store as many waveforms as needed for comparison or reference.
- Make measurements after signal is acquired. This is especially useful on single-shot signals or infrequent error conditions.
- Waveform data available over the HP-IB.
- Signal averaging for noise rejection and increased resolution.

**Automatic Measurements**

- Automatic edge finders save time, eliminate uncertainty, and reduce operator error in time-interval measurements.
- Measure pulse parameters automatically, without a controller.
- Markers indicate where the measurement was made, providing confidence in measurement results.

**Pre-trigger Display**

- Find causes of events.
- Displayed time can be any time before or after the trigger, and is not limited to one screen width before the trigger. Time intervals can be measured with a resolution of parts per million, before and after the trigger.

**Store Waveforms for Comparison and Reference**

- Pixel memories for overlaying multiple waveforms.
- Waveform memories for measurements and comparison of stored signals.

**Easy to Use**

- Pressing the Autoscale button automatically sets up the time base, sensitivity, offset, and trigger for a stable display over a wide range of input signals.
- Save up to ten front-panel setups in non-volatile memory; simplify a sequence of repeated measurements quickly.
- Instant hard copy with either a pen plotter or a graphics printer eliminates time-consuming, expensive photography.
- ECL and TTL presets scale the vertical gain, offset, and trigger levels for the selected logic family. This saves time in setting up for a measurement.

**Triggering on Complex Digital**

**Waveforms**

- Logic pattern triggering allows you to trigger on the complex events found in typical digital systems.
- Trigger holdoff can be specified by events or by time for stable triggering on long, complex sequences of events.
- Independent trigger threshold adjustments for each channel. No need to reset the trigger level each time you switch from one trigger source to another.

**Simplified Programming**

- Simple, logical, structured programming mnemonics make programs easy to edit, easy to understand, and easy to modify for new applications.
- Measurement-oriented, English-like mnemonics.

**Document Results**

Active as well as stored waveforms, setup conditions, and measurement results can be printed or plotted for instant, low-cost documentation. HP printers provide report-quality hard copy for articles or printed reports at minimal cost, and without the delay of photographic reproduction.

**Color as a Measurement Tool**

The addition of color to an oscilloscope can improve productivity in applications that are performed manually as well as in those that use automated measurements. Color can be combined with intensity, line types, and modulation to create easier, faster measurements with fewer errors than with a monochrome oscilloscope.

The 54100- and 54120-series oscilloscopes can display a high-resolution, flicker-free color representation of rapidly changing data on a nine-inch raster display. The user can work with as many as nine colors at one time, selecting these nine from a total of 4096 available. For convenience, a default nine-color palette provides optimum viewing for users in standard laboratory environments.

Adding color to an instrument such as an oscilloscope aids the user in four ways:

- it helps in differentiating between overlapping, superimposed, or similar waveforms;
- it helps in associating displayed information with corresponding data or waveforms;
- it can be used to emphasize displayed information
- it allows the user to choose colors and their use in order to compensate for color blindness, ambient conditions, or special test requirements.



## Condensed Specifications

### Input Characteristics (channel A and B)

#### Range

DC coupled, 0 to 100 MHz.  
AC 1 M $\Omega$ , 30 Hz to 100 MHz.  
AC 50  $\Omega$ , 200 kHz to 100 MHz.

NOTE: Channel A range 200 MHz when in Frequency A and Ratio modes.

#### Sensitivity (X1)

25 mV rms sinewave.  
75 mV peak-to-peak pulse at minimum pulse width of 5 ns.

#### Dynamic Range (X1)

75 mV to 5 V peak-to-peak, to 100 MHz.  
75 mV to 2.5 V peak-to-peak, >100 MHz.

#### Signal Operating Range (X1, DC)

-5 V dc to +5 V dc.

#### Trigger Level Range (X1)

##### Auto Trigger OFF

Preset: set to 0 V dc NOMINAL.  
Adjustable: -5 V dc to +5 V dc.

##### Auto Trigger ON

Preset: set to nominal 50% point of input signal.  
Adjustable: nominally between + and - peaks of input signal.

#### Auto Trigger (X1)

##### Range (50% duty cycle)

DC coupled, 30 Hz to 200 MHz.  
AC 1 M $\Omega$ , 30 Hz to 200 MHz.  
AC 50  $\Omega$ , 200 kHz to 200 MHz.

Minimum signal: 100 mV rms.

Duty cycle range: 10% to 90%.

Response time: 3 seconds, typical.

NOTE: Auto Trigger requires a repetitive signal.

Coupling: ac or dc, switchable.

Impedance: 1 M $\Omega$ , nominal, shunted by <35 pF or 50  $\Omega$  nominal, switchable. In COMMON A, 1 M $\Omega$  is shunted by <50 pF.

Attenuator: X1 or X10 nominal, switchable.

Slope: independent selection of + or - slope.

Channel input: SEPARATE or COMMON A, switchable.

#### Frequency A

Range: 0 to 200 MHz, prescaled by 2.

#### LSD Displayed

$\frac{1 \text{ ns}}{\text{Gate Time}} \times \text{FREQ.}$  (e.g. 9 digits in a second).

#### Resolution

$\pm (2 \times \text{LSD}) \pm 1.4 \times \frac{\text{Trigger Error}}{\text{Gate Time}} \times \text{FREQ.}$

Accuracy:  $\pm (\text{Resolution}) \pm (\text{Time Base Error}) \times \text{FREQ.}$

#### Period A

Range: 10 ns to  $10^7$  s.

#### LSD Displayed

$\frac{1 \text{ ns}}{\text{Gate Time}} \times \text{PER.}$  (e.g. 9 digits in a second).

Period average: user selects MEAN function, and n = 100, or n = 1,000.

#### Time Interval A $\rightarrow$ B

Range: 0 ns to  $10^7$  s.

LSD displayed: 1 ns (100 ps using MEAN).

Resolution:  $\pm (2 \times \text{LSD}) \pm (\text{START Trigger Error}) \pm (\text{STOP Trigger Error})$ .

Accuracy:  $\pm (\text{Resolution}) \pm (\text{Time Base Error}) \times \text{TI} \pm (\text{Trigger Level Timing Error}) \pm (2 \text{ ns})$ .

Gate mode: MIN only.

Time interval average: user selects MEAN function, and n = 100, or n = 1,000.

#### Time Interval Delay (holdoff)

Front panel Gate Adjust control inserts a variable delay between START and enabling of STOP. Electrical inputs during delay are ignored. Delay ranges are same as gate time ranges (100  $\mu$ s, to 4 s NOMINAL) for gate modes of Fast, Norm, and Manual.

#### Inverse Time Interval A $\rightarrow$ B

Range:  $10^{-7}$  to  $10^9$  units/second.

LSD Displayed, Resolution, and Accuracy are inverse of Time Interval A $\rightarrow$ B specifications.

#### Rise and Fall Time A

Range: 20 ns to 10 ms transition with 50 Hz to 25 MHz repetition rates (50% duty cycle).

Minimum pulse height: 500 mV peak-to-peak.

Minimum pulse width: 20 ns.

Duty cycle range: 20% to 80%.

LSD Displayed and Resolution are same as Time Interval A $\rightarrow$ B Specifications.

#### Pulse Width A

Range: 5 ns to  $10^7$  s.

Trigger point range: 40% to 60% of pulse height.

LSD Displayed and Resolution are same as Time Interval A $\rightarrow$ B specifications.

#### Duty Cycle A

Range: 1% to 99%, 0 to 100 MHz.

Trigger point range: 40% to 60% of pulse height.

LSD displayed:  $\frac{1 \text{ ns}}{\text{PER}} \times 100\%$

NOTE: Constant duty cycle required during measurement.

#### Slew Rate A

Range: 50 V/s to  $10^8$  V/s slew rate with 50 Hz to 25 MHz repetition rates (50% duty cycle). Minimum Pulse Height, Width, and Duty Cycle Range are same as Rise and Fall Time A.

Input mode: automatically set to COMMON A with 10% and 90% trigger levels.

#### Ratio A/B

Range: Channel A, 0 to 200 MHz (prescaled by 2).  
Channel B, 0 to 100 MHz.

LSD displayed:  $\frac{\text{RATIO}}{\text{FREQ} \times \text{Gate Time}}$  where FREQ is higher frequency after prescaling.

#### Totalize A

Range: 0 to 100 MHz.

LSD displayed: 1 count of input.

HP-IB output: at end of gate.

#### Manual

Count reset: via RESET key.

HP-IB output: totalize data on-the-fly sent if Cycle mode set to Single. Input frequency range in this mode is 0 to 50 Hz nominal.

#### Gated

Count reset: automatic after measurement.

#### Phase A Rel B

Range: -180 $^\circ$  to 360 $^\circ$ , Range Hold off, or 0 $^\circ$  to 360 $^\circ$ , Range Hold on, with signal repetition rates of 30 Hz to 1 MHz.

Minimum signal: 100 mV rms.

LSD displayed: 0.1 $^\circ$ .

#### Gate Time

Range: 100 ns to  $10^7$  s.

LSD displayed: up to three digits with Ext. Arm Enable OFF, 100 ns when ON. MIN Gate Mode display zero.

# ELECTRONIC COUNTERS

## Our Highest Performance Universal Systems Counter (cont'd)

### HP 5335A

#### Trigger Level

**Range:**  $\times 1$ , +5 to -5 V;  $\times 10$ , +50 to -50 V.

**Resolution:**  $\times 1$ , 10 mV;  $\times 10$ , 100 mV.

**Accuracy ( $\times 1$ ):**  $\pm 20$  mV,  $\pm 0.5\%$  of reading.

#### Time Base

##### Standard Crystal

**Frequency:** 10 MHz.

**Aging rate:**  $< 3 \times 10^{-7}$ /month.

**Temperature:**  $< 4 \times 10^{-6}$ , 0 to 50°C.

**Line voltage:**  $< 1 \times 10^{-7}$  for 10% change.

**High stability crystal:** see Option 010.

**External time base input:** rear panel BNC accepts 5 or 10 MHz, 200 mV rms into 1 k $\Omega$ ; 5 V rms maximum.

**Time base out:** 10 MHz,  $> 1$  V p-p into 50  $\Omega$  via rear panel.

#### Statistics

**Sample size:** selectable between either  $n = 100$  or  $n = 1,000$  samples.

**Std. dev.:** displays a standard deviation of selected sample size.

**Mean:** displays mean estimate of selected sample size.

**Smooth:** performs a weighted running average and truncates unstable least significant digits from display.

#### Math

All measurement functions, with exception of GATE TIME, Totalize in Scale Mode, and TRIG LVL, may be operated upon by Math functions. Offset, Normalize, and Scale may be used independently or together as follows:

$$\text{Display} = \frac{\text{Measurement} + \text{Offset}}{\text{Normalize}} \times \text{Scale}.$$

**Number value range:**  $\pm 1 \times 10^{-9}$  to  $\pm 9 \times 10^9$ .

**Last display:** causes value of previous display to Offset (negative value), Normalize, or Scale all subsequent measurements.

**Measurement t-1:** causes each new measurement to be Offset (negative value), Normalized, or Scaled by each immediately preceding measurement.

#### Hewlett-Packard Interface Bus

**Programmable controls:** all measurement functions, Math, Statistics, Reset, Range Hold, Ext. Arm Enable/Slope, Check, Gate Adj. ( $\sim 1$  ms to 1 s), Gate Open/Close (gate times to  $\infty$ ), Gate Mode, Cycle, Preset, Slope, Common A, Auto Trigger.

**Special functions:** FREQ B, PULSE B, TIME B  $\rightarrow$  A, TOT A-B, LEARN, MIN, MAX, all internal diagnostic routines.

**Interface functions:** SH1, AH1, T5, TE $\theta$ , L4, LE $\theta$ , SR1, RL1, PP $\theta$ , DC1, DT1, C0, (see page 579).

**Data output:** fixed output format consisting of 19 characters plus CR and LF output in typically 8 ms.

**Option 040:** adds complete systems programmability; see column at right.

#### General

**Gate:** minimum, manual, or continuously variable (NORM/FAST) via Gate Adj. control.

**NORM:** 20 ms to 4 s NOMINAL.

**FAST:** 100  $\mu$ s to 20 ms NOMINAL.

**MIN:** minimum gate time. Actual time depends on function.

**MANUAL:** each press opens or closes gate.

**Cycle:** determines delay between measurements.

**NORM:** no more than 4 readings per second, nominal.

**MIN:** updates display as rapidly as possible ( $\sim 15$  readings per second, depending on function).

**SINGLE:** one measurement taken with each press of button.

**Arming:** Ext. Arm Enable key allows rear panel input to determine Start and/or Stop point of a measurement. External gate defined by both Start and Stop armed. All measurements are armable except Manual Totalize, Phase, and Trigger Level.

**Start arm:** + or - slope of arm input signal starts measurement.

**Stop arm:** + or - slope of arm input signal stops measurement. When used, Start Arm must occur before Stop Arm.

**Ext. arm input:** rear panel BNC accepts TTL into 20 k $\Omega$ . Minimum Start To Stop Time: 200 ns.

**Trigger level out:** dc output into 1 M $\Omega$  via rear panel BNCs for Channel A and B; not adjusted for attenuators.

**Accuracy at dc ( $\times 1$ ):**  $\pm 15$  mV  $\pm 0.5\%$  of TRIG LVL reading.

**Gate out:** TTL level into 50  $\Omega$ ; goes low when gate open; rear panel BNC.

**Range hold:** freezes decimal point and exponent of display.

**Reset:** starts a new measurement cycle when pressed.

**Check:** performs internal self test and lamp test.

**Display:** 12-digit LED display in engineering format; exponent range of +18 to -18.

**Operating temperature:** 0 to 50°C.

**Power requirements:** 100, 120, 220, 240 VAC (+5%, -10%), 48-66 Hz; 130 VA max.

**Weight:** net, 8.8 kg (19 lb 8 oz). Shipping, 13.6 kg (30 lb).

**Dimensions:** 425.5 mm W x 132.6 mm H x 345.4 mm D (16 $\frac{3}{4}$  in. x 5 $\frac{1}{4}$  in. x 13 $\frac{1}{2}$  in.), not including removable handles.

#### Options

##### Option 010: High Stability Time Base (oven)

**Frequency:** 10 MHz.

**Aging rate:**  $< 5 \times 10^{-10}$ /day after 24-hour warm up.

**Short term:**  $< 1 \times 10^{-10}$  rms for 1s average.

**Temperature:**  $< 7 \times 10^{-9}$ , 0 to 50°C.

**Line voltage:**  $< 1 \times 10^{-10}$  for 10% change.

**Warm-up:** within  $5 \times 10^{-9}$  of final value in 20 minutes.

##### Option 020: DC Digital Voltmeter

**Range:** 4 digits, autoranging, autopolarity, in  $\pm 10$ ,  $\pm 100$ ,  $\pm 1000$  V ranges.

**Sensitivity:** 100  $\mu$ V, 1 mV, 10 mV, 100 mV for  $\pm 1$  V,  $\pm 10$  V,  $\pm 100$  V,  $\pm 1000$  V readings.

**LSD displayed:** same as sensitivity.

**Input type:** floating pair.

**Input impedance:** 10 M $\Omega$   $\pm 1\%$ .

##### Option 030: 1.3 GHz C Channel

###### Input Characteristics

**Range:** 150 MHz to 1.3 GHz.

**Sensitivity:** 10 mV rms sinewave (-27 dBm) to 1 GHz. 100 mV rms sinewave (-7 dBm) to 1.3 GHz.

###### Frequency C

**Range:** 150 MHz to 1.3 GHz, prescaled by 20. LSD Displayed, Resolution, and Accuracy are same as Frequency A.

###### Ratio C/A

**Range:** channel A, 0 to 200 MHz.

channel C, 150 to 1300 MHz.

##### Option 040: Complete Systems Programmability

Adds remote selection of low pass filter, ac/dc coupling,  $\times 1$ - $\times 10$  attenuation, dc trigger level and input impedance for both Channel A and B.

#### Definitions

**Duty cycle:** percentage of time a signal is high or low, depending on Slope A setting. Trigger point is high/low dividing point.

$$\text{DUTY CY} = \frac{\text{PULSE}}{\text{PER}} \times 100\%.$$

**Slew rate:** effective slope between 10% and 90% points of rising or falling signal depending on Slope A setting.

$$\text{SLEW} = \frac{V_B - V_A}{T_I}$$

**Phase:** angle, with respect to B signal, between 50% points of channel A and B signals, trigger slopes selected by Channel A and B slope switches.

$$\text{PHASE} = \frac{(T_{I1} + T_{I2}) 360^\circ}{2 \text{ PER}}$$

$T_{I1}$  is time between 50% points of A then B signals using slopes defined during Phase measurement.

$T_{I2}$  is time between 50% points of A then B signals using complement slopes to  $T_{I1}$ .

**Front handles:** supplied with instrument.

#### Ordering Information

HP 5335A Universal Counter

Opt 010 Oven Oscillator

Opt 020 DVM

Opt 030 C Channel

Opt 040 Expanded HP-IB Control

Opt 908 Rack Flange Kit for use without handles.

Opt 913 Rack Flange Kit for use with supplied front handles.

Opt W30 Extended repair service. See page 723.

Opt W32 Calibration service. See page 723.

☎ For same day shipment, call HP DIRECT at 800-538-8787

#### Price

\$5,000 ☎

+ \$960

+ \$710

+ \$985

+ \$905

+ \$33

+ \$65

# ELECTRONIC COUNTERS

## 100 MHz Universal Counters

### HP 5328B

139

- 100 MHz and 1300 MHz
- 10 ns Time Interval
- T.I. Averaging to 10 ps resolution

- "Armed" measurements
- DVM option
- HP-IB Interface standard

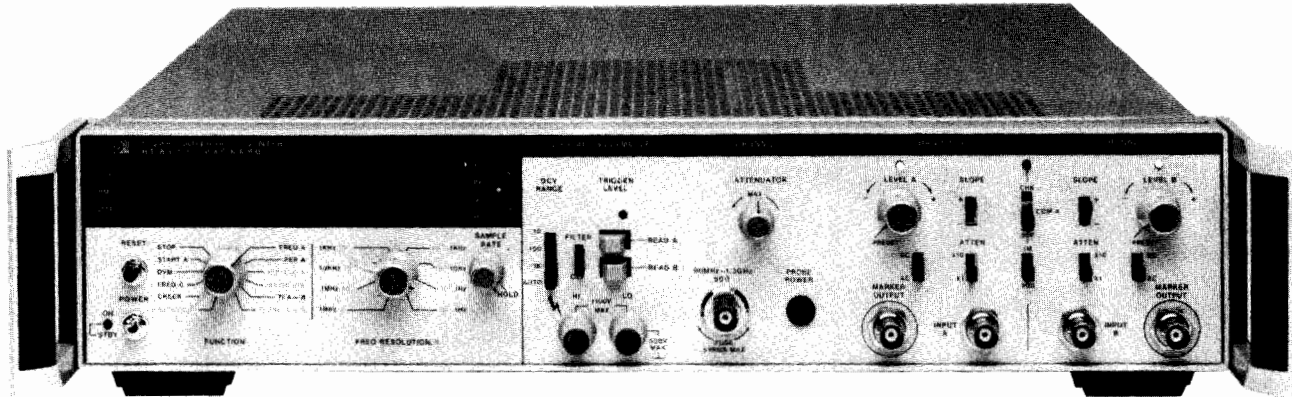

DESIGNED FOR  
**HP-IB**  
SYSTEMS

HP 5328B

### HP 5328B Universal Counter

- Frequency measurements to 100 MHz, 1.3 GHz optional.
- 10 ns Time Interval resolution, 10 ps with averaging.
- 10 ns Period resolution, 1 fs with averaging.
- $\pm 1000$  V dc DVM and High Stability Oven Time Base options.
- HP-IB programming and External Arming standard.

### Condensed Specifications

#### Input Characteristics

**Sensitivity:** 25 mV rms, to 40 MHz; 50 mV rms, 40 MHz-100 MHz.

**Attenuators (nominal):**  $\times 1$ ,  $\times 10$  switch selectable.

**Frequency A range:** 0 to 100 MHz.

**Period A range:** 10 ns to  $10^7$ s with resolution to 10 ns.

**Period average A range:** 100 ns to  $10^7$ s with resolution to 1 fs.

**Time interval A  $\rightarrow$  B range:** 10 ns to  $10^7$ s with resolution to 10 ns.

**Time interval average A  $\rightarrow$  B range:** 0.1 ns to 1 s with resolution to 10 ps.

**Minimum dead time:** 40 ns.

**Ratio B/A range:** Channel A, 0 to 10 MHz; Channel B, 0 to 100 MHz.

#### HP-IB Interface Bus

**Programmable functions:** Functions, resolution, sample rate, (maximum or manual control), arming, display modes, measurement modes, output mode, and reset commands. Trigger level, trigger slope, input impedance, coupling, separate/common/check, invert A and B, Trigger level is programmable in 10 mV steps in  $\times 1$ ; 100 mV in  $\times 10$ . Trigger level accuracy under remote control in  $\times 1$ :  $\pm 35$  mV.

**Interface functions:** SH1, AH1, T1, L2, SR1, RL1, PP0, DC1, DT1, C0, E1. (See page 579).

**Service request (SRQ):** if enabled, indicates end of measurement.

**Maximum data output rate:** 500 readings/s.

#### General

**Display:** 9-digit LED display.

**Sample Rate:** Variable from less than 2 ms between measurements to HOLD, which holds display indefinitely.

**Gate Output:** rear panel output: TTL levels.

**Time Base Output:** rear panel output; TTL levels.

**Operating Temperature:**  $0^\circ$  to  $50^\circ\text{C}$ .

**Power Requirements:** 100/120/240 V rms, +5%, -10% (switch selectable), 48-66 Hz; 150 VA max.

#### Time Base Oscillators

##### Standard Crystal Oscillator

**Frequency:** 10 MHz.

**Aging Rate:**  $< 3 \times 10^{-7}$ /month.

**Temperature:**  $< 2.5 \times 10^{-6}$ ,  $0^\circ$  to  $50^\circ\text{C}$ .

**Line Voltage:**  $< 1 \times 10^{-7}$  for 10% change.

##### Option 010: Oven Oscillator

**Frequency:** 10 MHz.

**Aging Rate:**  $< 5 \times 10^{-10}$ /day after 24-hour warm-up.

**Short Term:**  $< 1 \times 10^{-10}$  rms/s.

**Temperature:**  $< 7 \times 10^{-9}$ ,  $0^\circ$  to  $50^\circ\text{C}$ .

**Line Voltage:**  $< 5 \times 10^{-9}$  for 10% variation.

**Warm-Up:** within  $5 \times 10^{-9}$  of final value in 10 minutes.

##### Option 021: High Performance Digital Voltmeter

**Range:**  $\pm 10$ ,  $\pm 100$ ,  $\pm 1000$  V dc and Autorange.

**Sensitivity:** 10  $\mu\text{V}$ , 100  $\mu\text{V}$ , 1 mV, 10 mV, 100 mV for measurement times of 10 s, 1 s 0.1 s, 10 ms, 1 ms respectively.

**Input:** floating pair, 10 M $\Omega$  nominal.

**Maximum Input:** hi to low:  $\pm 1100$  V all ranges; low to chassis ground:  $\pm 500$  V.

**Trigger Level Measurements:** 1 mV display resolution.

##### Option 031: 1300 MHz C-Channel

#### Input Characteristics

**Sensitivity:** 20 mV rms sine wave (-21 dBm).

**Maximum Input:** 5 V rms,  $\pm 5$  Vdc, fuse protected.

#### Frequency C

**Range:** 90 MHz to 1300 MHz, prescaled by 4 with resolution to 0.1 Hz.

#### Ratio C/A

**Range:** channel A, 0 to 10 MHz; channel C, 90 to 1300 MHz

**Attenuation:** continuously variable for optimum noise suppression.

#### Ordering Information

HP 5328B Universal Counter

Opt 010 High Stability Time Base

Opt 021 High Performance DVM

Opt 031 1300 MHz Channel C

Opt 050 DVM and Channel C

Opt 908 No Handles Rack Flange Kit

Opt 913 With Handles Rack Flange Kit

Opt W30 Extended repair service. See page 723

Opt W32 Calibration service. See page 723

#### Price

\$6,570

+\$960

+\$910

+\$1,215

+\$2,125

+\$30

+\$30

# ELECTRONIC COUNTERS

## Universal Counters

HP 5315A, 5316B

- Frequency, period, ratio, and totalize to 100 MHz
- Portable, and HP-IB models
- 1 GHz capability available

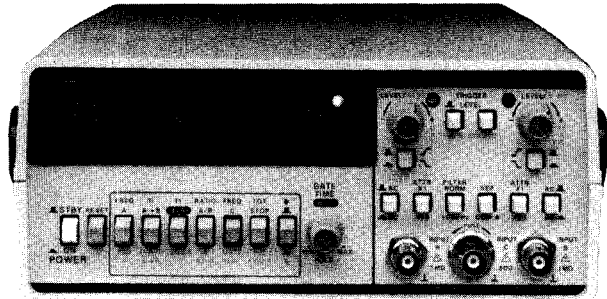

HP 5315A

- Uses reciprocal technique for full low-frequency resolution
- 100 ns time interval, 10 ps T.I. averaging
- Oven option for increased accuracy

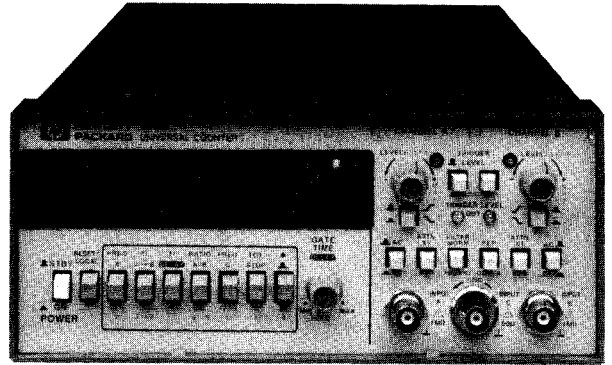

HP 5316B

Supported by  
**HP ITG**  
Software



## HP 5315A and HP 5316B Universal Counters

### A Quiet Revolution in Capability

HP's economical HP 5315A and HP 5316B counters provide all the universal counter capability you've come to expect at much higher prices. That's because they use a unique custom circuit called the MRC (Multiple Register Counter) which packs counting and computing power into this popular counter series. To a user, the differences in operation from conventional direct models can be listed quickly: low frequency resolution is an outstanding 7 digits per second of gate time and reliability is extremely good due to the counter's low chip count. Also, the continuously adjustable gate time allows automatic selection of sample size for easy trade-offs between measurement time and resolution.

Much of the counter's performance is based on reciprocal counting techniques first pioneered in HP's high-performance HP 5360A computing counter, and the current HP 5345A Universal Counter. The use of these techniques coupled with HP's MRC and a microprocessor provides a quiet but powerful revolution in counter performance within the HP 5315A and HP 5316B. For example, this counter gives you its full 7-digits/second resolution over the range from 1 Hz to 100 MHz. This, simply stated, shows the power of the MRC and reciprocal counting.

### High Performance, Low Price

In addition to its economy, the MRC counter offers a full set of universal counter measurements, and there are very few limitations to this capability. Increased accuracy in low-cost portable and system counters is also available with the oven oscillator option through improved temperature stability and lower aging rates.

### Frequency to 100 MHz, C-Channel to 1.0 GHz

The MRC counter measures frequency to 100 MHz. Additionally the optional C-Channel measures to 1.0 GHz for both CW and pulsed RF signals as narrow as 60 ms. The C-Channel option is particularly useful in navigation and communications equipment testing due to this pulsed RF measurement feature.

### Time Interval to 100 ns, T.I. Averaging to 10 ps

The MRC counter provides three time measurement modes. Single-shot time interval allows measurements over a range of 100 ns to 100,000 seconds. This capability can be used to measure pulse width. Time interval averaging provides greater resolution for repetitive events. Finally, time interval delay avoids measurement of spurious signals by holding off the counter's trigger point by a precise, operator-selectable amount of time.

### A Full Set of Measurements

Besides the frequency and time functions mentioned above, the MRC counter has other measurement functions that make it a truly impressive value:

**Period A**—allows single period measurements via Channel A.

**Ratio A/B**—allows frequencies to 100 MHz in both Channel A and B.

**A By B**—totalizes the A input between 2 events on B channel.

**Totalize**—a manually gated totalize mode of operation.

### Input Signal Conditioning Versatility

A full complement of input signal conditioning controls are provided for both channels. These include  $\pm$  slope,  $\pm 2.5$  Vdc trigger level, and ac/dc coupling. Other controls are a Separate/Common switch, and a 100 kHz low-pass filter for Channel A.

### A Choice of Portable or System Models

**HP 5315A:** a portable, light-weight unit best suited for field applications. This unit has a convenient carrying handle and optional battery power is available for up to 4 hours continuous operation.

**HP 5316B:** this model possesses all the characteristics of the HP 5315A, and it has HP-IB capability built-in as standard equipment. It has low RFI, it is rackable, and it is functionally identical to the HP 5315A. In addition to programmable measurement functions, the user can also select dc trigger level and  $\pm$  slope under HP-IB control. Channel A and B trigger levels are brought out to the front panel on this unit for easy measurement with a DVM.

## HP 5315A, 5316B Condensed Specifications

### Input Characteristics (channel A and channel B)

**Range:** dc coupled, 0 to 100 MHz.

ac coupled, 30 Hz to 100 MHz.

**Sensitivity:** 10 mV rms sine wave to 10 MHz. 25 mV rms sine wave to 100 MHz. 75 mV peak-to-peak pulse at minimum pulse width of 5 ns.

Sensitivity can be varied continuously up to 500 mV rms *NOMINALLY* by adjusting sensitivity control. In sensitivity mode, trigger level is automatically set to 0 V *NOMINAL*.

### Dynamic Range

30 mV to 5 V peak-to-peak, 0 to 10 MHz.

75 mV to 5 V peak-to-peak, 10 to 100 MHz.

**Coupling:** ac or dc, switchable.

**Filter:** low pass, switchable in or out of Channel A. 3 dB point of 100 kHz *NOMINALLY*.

**Impedance:** 1 M $\Omega$  *NOMINAL* shunted by less than 40 pF.

**Signal operating range:** +2.5 Vdc to -2.5 Vdc.

**Attenuator:**  $\times 1$  or  $\times 20$  *NOMINAL*.

**Trigger level:** variable between +2.5 Vdc and -2.5 Vdc.

**Slope:** independent selection of + or - slope.

**Common input:** all specifications are the same for Common A except the following:

**Sensitivity:** 20 mV rms sine wave to 10 MHz; 50 mV rms to 100 MHz; 150 mV peak-to-peak at a minimum pulse width of 5 ns.

**Dynamic range:** 60 mV to 5 V peak-to-peak to 10 MHz; 150 mV to 5 V peak-to-peak, 10-100 MHz.

**Impedance:** 500 k $\Omega$  *NOMINAL* shunted by less than 70 pF.

### Frequency (channel A)

**Range:** 0.1 Hz to 100 MHz.

**Resolution:** See Graph 1

**Accuracy:**  $\pm$  Resolution  $\pm$  Time Base Error (Graph 2)

### Period

**Range:** 10 ns to  $10^5$  s.

**Resolution:** See Graph 1

**Accuracy:**  $\pm$  Resolution  $\pm$  Time Base Error (Graph 2)

### Time Interval

**Range:** 100 ns to  $10^5$  s.

**LSD displayed:** 100 ns.

**Resolution:**  $\pm$  LSD  $\pm$  Noise Trigger Error (Graph 3)

**Accuracy:**  $\pm$  Resolution  $\pm$  Time Base Error (Graph 2)

### Time Interval Average

**Range:** 0 ns to  $10^5$  s.

**LSD displayed:** 100 ns/ $\sqrt{N}$ , 10 ps maximum.

**Number of intervals averaged (N):**  $N = \text{Gate Time} \times \text{FREQ.}$

**Minimum dead time (stop to start):** 200 ns.

**Resolution:**  $\pm$  LSD  $\pm$  [Noise Trigger Error (Graph 3)]/ $\sqrt{N}$

**Accuracy:**  $\pm$  Resolution  $\pm$  Time Base Error (Graph 2)  $\pm$  4 ns

### Time Interval Delay (holdoff)

Front panel gate time knob inserts a variable delay of *NOMINALLY* 500  $\mu$ s to 20 ms between START (Channel A) and enabling of STOP (Channel B). Electrical inputs during delay time are ignored. Delay time may be digitally measured by simultaneously pressing T.I. Averaging, T.I. Delay and blue key. Other specifications are identical to Time Interval

### Ratio

**Range:** 0.1 Hz to 100 MHz, both channels.

**LSD:** [(2.5 x Period A)/Gate Time] x Ratio.

### Totalize

#### Manual

Range: 0 to 100 MHz.

#### A gated by B

Totalizes input A between two events of B. Instrument must be reset to make new measurement. Gate opens on A slope, closes on B slope. Range: 0 to 100 MHz.

### General

#### Standard Time Base

**Frequency:** 10 MHz.

**Aging rate:**  $< 3 \times 10^{-7}$ /mo.

**Temperature:**  $\pm 5 \times 10^{-6}$ , 0° to 50°C.

**Line voltage:**  $< 1 \times 10^{-7}$  for a  $\pm 10\%$  variation.

**Check:** counts internal 10 MHz reference frequency.

**Error light:** LED warning light activated if logic error is found during instrument turn-on self-check.

**Display:** 8-digit LED display, with engineering units annunciator.

**Overflow:** only frequency and totalize measurements will overflow. In case of overflow, eight least significant digits will be displayed and front panel overflow LED will be actuated. All other measurements which would theoretically cause a display of more than 8 digits will result in the display of the 8 most significant digits.

**Gate time:** continuously variable, *NOMINALLY* from 60 ms to 10 s or 1 period of the input, whichever is longer.

**Sample rate:** up to 7 readings per second *NOMINALLY* except in time interval mode, where it is continuously variable *NOMINALLY* from 250 ms to 10 s via Gate Time Control.

**Operating temperature:** 0° to 50°C.

**Power requirements:** 100, 120, 220, 240 V (+5%, -10%) 48-66 Hz; 15 VA maximum or 30 VA maximum (HP 5316B).

**Weight:** net, 2.2 kg (4 lb 12 oz). Shipping, 4.1 kg (9 lb).

**Size:** 98 H x 238 W x 276 mmD (3 $\frac{7}{8}$ " X 9 $\frac{3}{8}$ " x 10 $\frac{7}{8}$ ".)

### Additional HP 5316B Specifications

Rack and stack metal case with rear panel, switchable ac power line module, Specifications same as HP 5315A except as follows:

**Rackmount kit:** HP 5061-9672 recommended.

**Oscillator output:** 10 MHz, 50 mV p-p into 50  $\Omega$  load on rear panel.

**External frequency standard input:** 1, 5, 10 MHz, 1 V rms into 500  $\Omega$ , or rear panel.

**Trigger level output:**  $\pm 5\%$ ,  $\pm 15$  mV, over  $\pm 2.0$  Vdc range at front panel connectors.

**Size:** 88 H x 212 W x 415 mm D (3 $\frac{1}{2}$ " x 8 $\frac{3}{8}$ " x 16 $\frac{1}{2}$ ".)

**Weight:** net, 3.7 kg (8 lb 2 oz); shipping, 6.3 kg (14 lb).

### Hewlett-Packard Interface Bus

**Programmable functions:** Frequency A and C, Frequency A Armed by B, Period A, Totalize A Gated by B, Ratio A/B, Time Interval A $\rightarrow$ B, Time Interval Average A $\rightarrow$ B, Time Int. Delay, Read Gate Time.

**Programmable controls:** Gate Time Command which sets long (60 ms to 10 s) or short (500  $\mu$ s to 30 ms) range; Trigger Level Commands which set Channel A and/or B slope ( $\pm$ ) and Channel A and/or B trigger from -2.50 Vdc to +2.50 Vdc in steps of .01V.

**HP-IB Interface Functions:** SH1, AH1, T1, L2, SR1, RL1, PP0, DC1, DT1, C0, E1 (see page 578).

### Options

**Opt 001:** High Stability Time Base (TCXO).

**Frequency:** 10 MHz.

**Aging rate:**  $< 1 \times 10^{-7}$ /mo.

**Temperature:**  $\pm 1 \times 10^{-6}$ , 0° to 40°C.

**Line voltage:**  $< 1 \times 10^{-8}$  for  $\pm 10\%$  variation.

# ELECTRONIC COUNTERS

## Universal Counters (cont'd)

HP 5315A, 5316B

**Opt 002:** Battery (HP 5315A only).

**Type:** rechargeable lead-acid (sealed).

**Capacity:** TYPICALLY 4 hours of continuous operation at 25 °C.

**Recharging time:** TYPICALLY 16 hours to 98% of full charge, instrument non-operating. Charging circuitry included with Option. Batteries not charged during instrument operation.

**Low voltage indicator:** instrument turns itself off automatically when low battery condition exists. *Discharge* LED flashes slowly when this happens. *Discharge* LED is on whenever battery is supplying power to instrument. *Charge* LED indicates state of charge of battery during charging only and is on whenever battery is charged to 95% *NOMINAL* of capacity. *Charge* LED flashes when 90% *NOMINAL* of charge taken out is replaced. *Charge* LED is off if charge is less than 70% *NOMINAL* of capacity.

**Line failure protection:** instrument automatically switches to battery in case of line failure.

**Weight:** Opt 002 adds 1.4 kg (3 lb) to weight of instrument.

**Option 003:** C Channel.

**Input Characteristics**

**Range:** 50 to 1000 MHz, prescaled by 10.

**Sensitivity:** 15 mV rms sinewave (-23.5 dBm) to 650 MHz. 75 mV rms sinewave (-9.5 dBm) to 1000 MHz. Sensitivity can be decreased continuously by up to 20 dB *NOMINAL*, 50 to 500 MHz and 10 dB *NOMINAL*, 500 to 1000 MHz by adjusting sensitivity control. Trigger level is fixed at 0 V *NOMINAL*.

**Dynamic range:** 15 mV to 1 V rms (36 dB), 50 to 650 MHz. 75 mV to 1 V rms (20 dB), 650 to 1000 MHz.

**Signal operating range:** +5 Vdc to -5 Vdc.

**Coupling:** ac.

**Impedance:** 50 Ω *NOMINAL* (VSWR, < 2.5:1 TYPICAL).

**Damage level:** ±8 V (dc + ac peak), fuse protected. Fuse located in BNC connector.

**Resolution and Accuracy:** same as Frequency A.

**Option 004:** High Stability OVEN Time Base

(HP 5315A only).

**Frequency:** 10 MHz.

**Aging rate:**  $< 3 \times 10^{-8}$  /mo\*.

**Temperature:**  $\pm 1 \times 10^{-7}$ , 0° to 50°C.

**Line voltage:**  $< 1 \times 10^{-8}$ , for a 10% variation.

Oven will operate continuously off of a fully charged battery for > 24 hours, typically, when in standby mode (no power applied, instrument OFF, and Freq. A button depressed).

(HP 5316B)

**Frequency:** 10 MHz.

**Aging rate:**  $< 3 \times 10^{-8}$  /mo.\*\*

**Temperature:**  $\pm 2 \times 10^{-8}$ , 0° to 50°C.

**Line Voltage:**  $< 1 \times 10^{-9}$ , for a 10% variation.

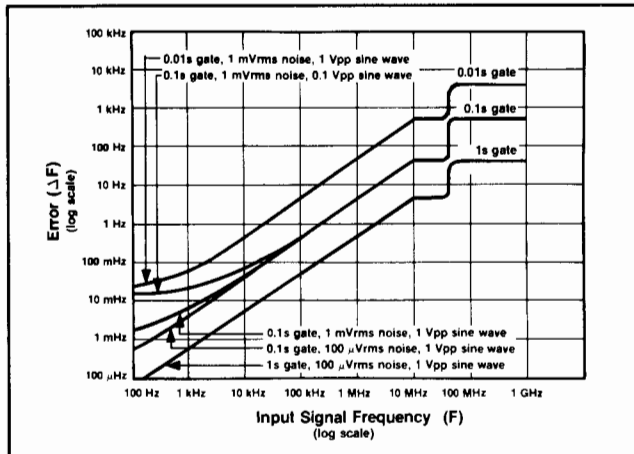

**Graph 1. Frequency Resolution Error:** Noise on input signal and internal uncertainties affect frequency and period measurements. For period, invert the period (P) of the input signal, and find frequency uncertainty ( $\Delta F$ ). Period uncertainty ( $\Delta P$ ) = ( $\Delta F/F$ ) x P.

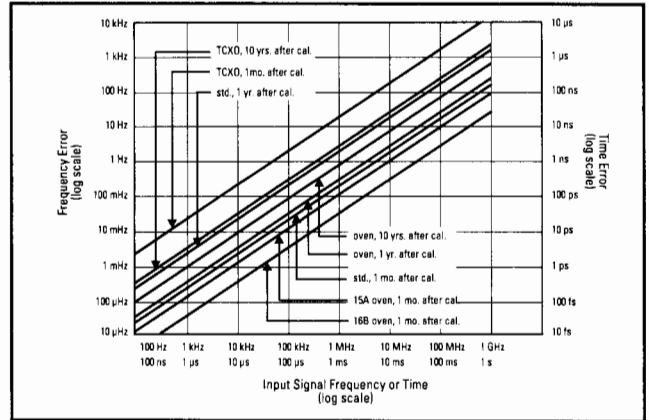

**Graph 2. Time Base Error:** Environment and aging of the crystal affects all measurements.

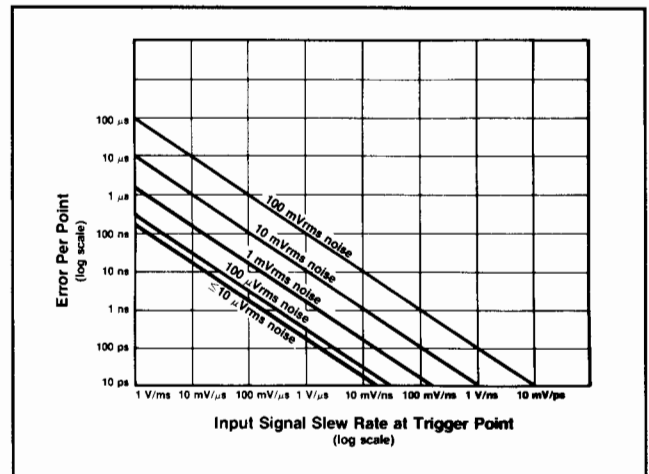

**Graph 3. Input Noise Trigger Error:** Noise on the input signal affects both the start and stop points of all time interval measurements.

\*After 30 days continuous operation (ac power applied, in OFF or ON position).

\*\*After 30 days continuous operation.  $< 5 \times 10^{-8}$  /mo., after 7 days continuous operation.

**Ordering Information**

HP 5315A Universal Counter  
HP 5316B Universal Counter

**Price**  
\$1295  
\$1595

		HP 5315A	HP 5316B	Price
Opt 001	TCXO Time Base	X	X	+ \$180
Opt 002	Battery Pack	X		+ \$330
Opt 003	C-Channel (1.0 GHz)	X	X	+ \$400
Opt 004	High Stability Time Base	X	X	+ \$600
Opt W30	Extended Repair Service	X	X	+ \$45
Opt W32	Calibration Service	X	X	5315: + \$575 5316: + \$550

**Required power options**

All HP 5315A orders must include one (1) of these line power options:

	Price
Opt 100 90-105 Vac	\$0
Opt 120 108-126 Vac	\$0
Opt 220 198-231 Vac	\$0
Opt 240 216-252 Vac	\$0

☎ For same-day shipment, call HP DIRECT at 800-538-8787

- 100 MHz
- 100 ns time interval
- Portable

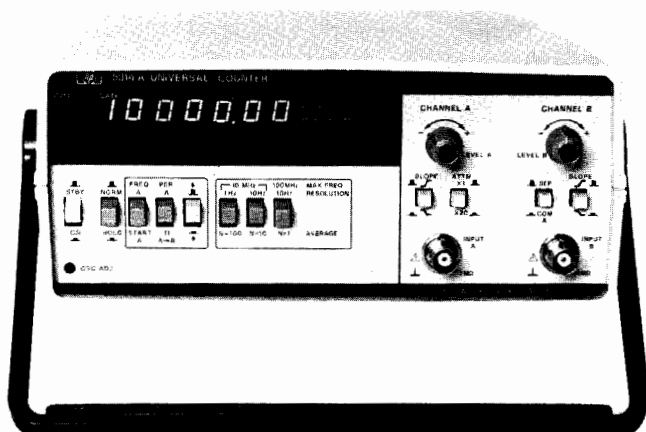

HP 5314A

### HP 5314A Universal Counter

The HP 5314A Universal Counter combines excellent performance and traditional HP quality at a very attractive price. This counter is designed to deliver reliable, high quality operation in such areas as: Production Test, Frequency Monitoring, Education, Training, Service and Calibration. Additionally, the optional battery (option 002) makes the HP 5314A especially attractive for field and portable applications.

#### Input Characteristics (channels A and B)

**Range:** CHANNEL A: 10 Hz to 10 MHz Direct.

1 MHz to 100 MHz Prescaled.

CHANNEL B: 10 Hz to 2.5 MHz.

**Sensitivity:** CHANNEL A: 25 mV rms to 100 MHz.

75 mV peak-to-peak at minimum pulse width of 5 ns (100 MHz range).

CHANNEL B: 25 mV rms to 2.5 MHz.

75 mV peak-to-peak at minimum pulse width of 200 ns.

**Coupling:** ac.

**Impedance:** 1 MΩ NOMINAL shunted by less than 30 pF.

**Attenuator:** ×1 or ×20 NOMINAL (A channel only).

**Trigger level:** continuously variable ± 350 mV times attenuator setting around average value of signal.

**Slope:** independent selection of + or - slope.

**Channel input:** selectable SEPARATE OR COMMON A.

**Dynamic range:** 75 mV p-p to 4 V p-p.

#### Frequency

**Range:** 10 Hz to 10 MHz direct count.

1 MHz to 100 MHz prescaled by 10.

**Least significant digit (LSD) displayed:** direct count 0.1 Hz, 1 Hz, 10 Hz switch selectable. Prescaled 10 Hz, 100 Hz, 1 kHz switch selectable.

**Resolution:** ± LSD.

**Accuracy:** ± LSD ± (time base error) x Freq.

#### Period

**Range:** 10 Hz to 2.5 MHz.

**LSD displayed:**  $\frac{100 \text{ ns}}{N}$  for N=1 to 1000 in decade steps of N.

**Resolution:** ± LSD ±  $\frac{(1.4 \times \text{TRIGGER ERROR})}{N}$

**Accuracy:** ± LSD ±  $\frac{(1.4 \times \text{TRIGGER ERROR})}{N}$

± (time base error) x Period.

#### Time Interval

**Range:** 250 ns to 1 s.

**LSD displayed:** 100 ns.

**Resolution:** ± LSD ± START trigger error ± STOP trigger error.

**Accuracy:** ± LSD ± START trigger error

± STOP trigger error ± (time base error) x TI.

External arming required for START/STOP channels.

#### Ratio (A to B)

**Range:** 10 Hz to 10 MHz CHANNEL A.

10 Hz to 2.5 MHz CHANNEL B.

**LSD displayed:** 1/N in decade steps of N for N = 1 to 1000.

**Resolution:** ± LSD ± (B trigger error x Frequency A)/N.

**Accuracy:** ± LSD ± (B trigger error x Frequency A)/N.

#### Totalize

**Range:** 10 Hz to 10 MHz.

**Resolution:** ± 1 count of input.

Totalize controlled by front panel switch.

#### General

**Check:** counts internal 10 MHz oscillator.

**Display:** 7 digit amber LED display with gate and overflow indication.

**Max sample rate:** 5 readings per second.

**Operating temperature:** 0° to 50 °C.

**Power requirement:** 115, +10%, -25%; 230 V, +9%, -17%; 48-66 Hz; 10 VA max.

**Weight:** 2.0 kg (4.4 lb).

**Dimension:** 238 mm W x 98 mm H x 276 mm D (9 $\frac{3}{8}$  in. x 3 $\frac{7}{8}$  in. x 10 $\frac{7}{8}$  in.).

#### Time Base

**Frequency:** 10 MHz.

**Aging rate:** < 3 parts in 10<sup>7</sup> per month.

**Temperature:** < ± 1 part in 10<sup>5</sup>, 0 to 50 °C.

**Line voltage:** < ± 1 part in 10<sup>7</sup> for ± 10% variation.

#### Options

##### Option 001 TCXO

**Frequency:** 10 MHz.

**Aging rate:** < 1 part in 10<sup>7</sup> per month.

**Temperature:** < ± 1 part in 10<sup>6</sup>, 0 to 40 °C.

**Line voltage:** < ± 1 part in 10<sup>8</sup> for ± 10% variation.

##### Option 002 Battery

**Type:** rechargeable lead-acid (sealed).

**Capacity:** typically 8 hours of continuous operation at 25 °C.

**Recharging time:** typically 16 hours to 98% of full charge, instrument non-operating. Charging circuitry included with option. Batteries not charged during instrument operation.

**Battery voltage sensor:** automatically shuts instrument off when low battery condition exists.

**Line failure protection:** instrument automatically switches to batteries in case of line failure.

**Weight:** Option 002 adds typically 1.5 kg (3.3 lb) to weight of instrument.

#### Accessories

Carrying case for half-rack size instruments

#### Definitions

**Resolution:** smallest discernible change of measurement result due to a minimum change in the input.

**Accuracy:** deviation from the actual value as fixed by universally accepted standards of frequency and time.

**Trigger error:**

$$\frac{\sqrt{(80 \mu\text{V})^2 + e_n^2}}{\text{input slew rate at trigger point } (\mu\text{V/s})} \text{ (rms)}$$

Where  $e_n$  is the RMS noise of the input for a 100 MHz bandwidth in CHANNEL A and 10 MHz bandwidth in CHANNEL B.

#### Ordering Information

HP 5314A 100 MHz/100 ns Universal Counter

**Price**

Opt 001 High Stability Time Base

\$690

Opt 002 Battery

+ \$180

Opt W30 Extended repair service. See page 723

+ \$180

Opt W32 Calibration service. See page 723

HP 34110A Carrying case

\$82

All orders must include one (1) of these line power options:

Opt 115 86-127 V

\$0

Opt 230 190-250 V

\$0

☎ For same day shipment, call HP DIRECT at 800-538-8787.

# POWER METERS

## Peak Power Analyzer, Peak Power Sensors

HP 8990A, 84812A, 84813A, 84814A



HP 8990A

### HP 8990A Peak Power Analyzer

#### Complete Pulse Power Characterization

The HP 8990A peak power analyzer provides complete and accurate characterization of today's complex pulsed signals. This new Peak Power Analyzer is capable of performing 8 automatic timing measurements (risetime, falltime, pulse width, PRI, PRF, duty cycle and delay) and 5 automatic power measurements (peak power, average power, pulse top/base amplitude and overshoot) with pushbutton ease. Front panel operation is intuitive and straightforward. Data entries can be typed in or made with the front panel knob; automatic measurements are made with simple keystrokes.

The HP 8990A offers two sensor channels plus two external triggering/oscilloscope channels which permits the simultaneous measurement of modulating signals and detected power envelopes. Powerful measurement and display routines put you in control of your most demanding pulse applications. Measurement statistics, high speed/high sensitivity triggering, amplitude and time markers, dual-timebase windowing, measurement limit test, waveform storage and waveform math are some of the new capabilities featured in the HP 8990A.

The peak power analyzer is compatible with the HP 84812A, 84813A and 84814A peak power sensors. These sensors and the HP 8990A combine to give you outstanding measurement accuracy in demanding situations:

- \*excellent sensor SWR holds over all power levels.
- \*automatic temperature sensing and correction.
- \*exceptionally low calibration uncertainty.
- \*automatic calibration routines for internal gain, offset and impedance variations.
- \*superior timebase precision.

With state-of-the-art peak power measurement accuracy, fast and complete pulse characterization, high performance triggering, traceability and reliability, the HP 8990A lets you measure your test signal with speed, precision and confidence.

#### HP 8990A Specifications

**Frequency range:** 500 MHz to 40 GHz, sensor dependent.

**Power range:** -40 to +20 dBm

**Rise/Falltime:**

-15 to +20 dBm: <5 ns

For lower power levels, rise time increases from 150 ns to 1 ms based on vertical sensitivity.

**Max Pulse repetition rate:** 100 MHz externally triggered, 1 MHz internally triggered.

**Linear vertical scale:** 50 nW/div to 20 mW/div in 1-2-5 sequence.

**Log vertical scale:** 1,2,5 dB/div

**Instrumentation uncertainty:**  $\pm 3.0\%$  (RSS)

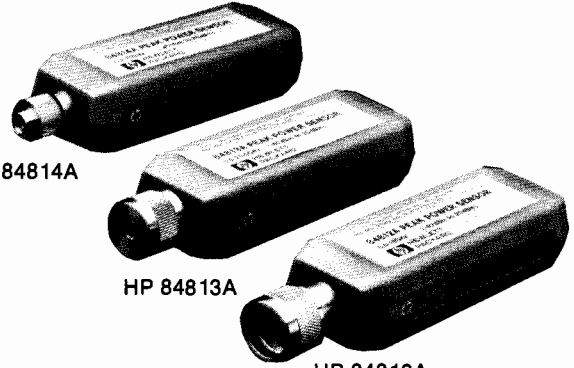

HP 84814A

HP 84813A

HP 84812A

#### Video inputs (channels 2 & 3)

**Bandwidth:** dc coupled: dc to 100 MHz (repetitive); dc to 1 MHz (single shot).

ac coupled: 10 Hz to 100 MHz (repetitive); 10 Hz to 1 MHz (single shot).

**Risetime:** <5 ns

**Vertical sensitivity:** 100 mV/div to 500 mV/div

**Vertical gain accuracy:**  $\pm 1.5\%$

**Available offset range:**  $\pm 20V$

**Time base**

**Range:** 2 ns/div to 5 s/div in 1-2-5 sequence.

**Resolution:** 100 ps

**Accuracy:** 0.005%

#### General characteristics:

**Power requirements:** Voltage: 90-132 or 198-264 Vac; 48-66 Hz. Power: 250 VA max.

**HP-IB codes:** SH1, AH1, T5, L4, SR1, RL1, PP1, DC1, DT1, C0, E2.

**Size:** 194 H x 422 W x 366 mmL (7.65" x 16.62" x 14.4")

**Weight:** Net, 12.3 kg (27 lb); shipping, 18.4 kg (40.5 lb)

#### HP 84812A/13A/14A Specifications:

**Frequency range:** HP 84812A: 500 MHz to 18 GHz

HP 84813A: 500 MHz to 26.5 GHz

HP 84814A: 500 MHz to 40 GHz

**Power range:** -40 to +20 dBm

**Sensor input return loss (SWR):**

500 MHz - 18 GHz: >20 dB (1.22)

18 GHz - 26.5 GHz: >17 dB (1.35)

26.5 GHz - 40 GHz: >12 dB (1.70)

**Connector type:** HP 84812A: Type-N (m)

HP 84813A: APC-3.5 mm (m)

HP 84814A: 2.4 mm (m)

#### General characteristics

**Size:** HP 84812A: 27H x 37W x 137 mmL (1.05" x 1.45" x 5.4")

HP 84813A: 27H x 37W x 127 mmL (1.05" x 1.45" x 5.0")

HP 84814A: 27H x 37W x 127 mmL (1.05" x 1.45" x 5.0")

**Weight:** net, 0.29 kg (0.64 lb); shipping, 0.64 kg (1.4 lb)

#### Ordering Information:

HP 8990A Peak Power Analyzer

HP 84812A Peak Power Sensor

HP 84813A Peak power Sensor

HP 84814A Peak Power Sensor

#### Price

\$15,000

\$1,400

\$1,600

\$1,900





HP 437B

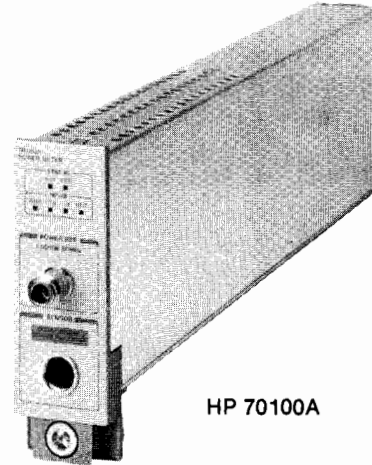

HP 70100A



HP E1416A

### HP 437B Power Meter

The HP 437B is a low-cost, high performance, single-channel, programmable, average Power Meter compatible with the HP 8480 family of thermocouple and diode power sensors. Depending on which Power Sensor is used, the HP 437B can measure from -70 dBm (100pW) to +44 dBm (25W) at frequencies from 100 KHz to 50 GHz.

Designed for ATE systems and demanding benchtop measurements, the HP 437B Power Meter makes fast, accurate and reliable average power measurements. Only 3 1/2 inches high and half rack wide, the HP 437B minimizes the use of critical rack space in ATE systems. The advanced plastics technology used in the HP 437B cabinet combines the light weight of plastic with the shielding effectiveness of metal, making the HP 437B the only power meter to meet MIL-STD-461C EMI specifications.

A modern and flexible feature set makes this meter easy to use in any application:

- Automatic calibration and zeroing.
- Frequency entry instead of Cal Factor.
- Ten pre-loaded sensor Cal Factor versus frequency tables.
- Selectable resolution to 0.001 dB.
- Offset entry in dB.
- Duty cycle entry for a convenient peak power representation of the measured average power.
- Ten store/recall registers.
- HP-IB is standard.
- Analog meter is a standard feature.

With a measurement speed twice as fast as that of the industry-standard HP 436A, powerful programming capability, state-of-the-art accuracy and exceptional reliability, the HP 437B lets you measure your test signal with speed, precision and confidence.

### HP 70100A and E1416A MMS and VXI Power Meters

The HP 70100A is a full-feature single channel power meter module for the Modular Measurement System (see page 189). It has all the capability of the HP 437B Power Meter in an 1/8th rack-width module. The HP 70100A features the same modern and flexible feature set as the HP 437B, the same state-of-the-art accuracy and is also fully compatible with the HP 8480 series of power sensors. The HP E1416A power meter is a VXI version of the HP 70100A. For information on the HP E1416A refer to page 627.

### HP 437B, 70100A, and E1416A Specifications

- Frequency Range:** 100 kHz to 50 GHz, sensor dependent.
- Power Range:** -70 to +44 dBm (100pW to 25W), sensor dependent.
- Power Sensors:** Compatible with all HP 8480 series Power Sensors.
- Dynamic Range:** 50 dB in 10 dB steps.
- Display Units:** Absolute: Watts, dBm; Relative: percent, dB.
- Resolution:** Selectable resolution of 0.1, 0.01 and 0.001 dB in logarithmic mode; or 1%, 0.1% and 0.01% of full scale in linear mode.

### Accuracy

**Instrumentation:** ±0.02 dB or ±0.5%.

**In REL mode:** ±0.02 dB or ±0.5% within measurement range; ±0.04 dB or 1% outside measurement range.

**Zero Set:** ±0.5% of full scale on most sensitive range.

### Power Reference

**Power Output:** 1.00mW, Factory set to ±0.7% traceable to US National Institute of Standards and Technology.

**Accuracy:** ±1.2% worst case (±0.9% RSS) for one year.

### General (HP 437B only)

**EMI:** Radiated and Conducted Emissions and Radiated and Conducted Susceptibility are within the requirements of RE02, CE03, RS01/03 and CS01/03 called out in MIL-STD-461C, and within the requirements of VDE 0871 and CISPR Publication 11.

**Rear Panel Output:** Analog 0-1 volt without digital filtering or Cal Factor correction, 1 kohm output impedance, BNC connector.

**Line Voltage:** 100 and 120 Vac, +5%-10%, 48-66 Hz, 360-440 Hz; 220 and 240 Vac, +5%-10%, 48-66 Hz.

**Power Requirement:** 8 Watts maximum (10 VA max).

**Weight:** Net 2.6 kg (5.9 lbs); shipping 4.5 kg (10 lbs).

**HP-IB Codes:** SH1, AH1, T5, TE0, L4, LE0, SR1, RL1, PP1, DC1, DT1, C0.

**Dimensions:** 88m H x 212mm W x 273mm D (3.46" H x 8.35" W x 10.75" D).

### Accessories

**Furnished:** HP 11730A, 1.5m (5 ft.) cable for power sensors; 2.4m (7.5 ft.) power cable. Mains plug shipped to match destination requirements.

**Available:** To select or substitute non-standard lengths for power sensor cable, see page 146. To rack mount one HP 437B order part number 5060-0173. To rack mount two HP 437B power meters, order part number 5060-0174.

### Ordering Information

	<b>Price</b>
HP 437B Power Meter	\$2500 ☎
Opt 002 Supplies a parallel rear panel sensor input	+\$75
Opt 003 Supplies a parallel rear panel sensor input and moves reference oscillator to rear panel	+\$75
Opt 004 Delete the HP 11730A sensor cable	-\$75
Opt 001 Provides side-carrying handle and standoff feet	+\$25
Opt 915 Service Manual	+\$25
Opt 916 Extra Operating Manual	+\$65
Opt W30 Two additional years of return-to-HP warranty	+\$100
Opt H36 Additional analog meter	\$2900
HP 70100A Power Meter Module	\$0
Opt 003 Moves reference oscillator from front to rear panel	-\$75
Opt 004 Delete the HP 11730A Power Sensor Cable	-\$250
Opt 005 Delete reference oscillator	+\$70
Opt W30 Extended repair service. See page 723.	

☎ For same-day shipment, call HP DIRECT at 800-538-8787

# POWER METERS

## Power Meters

HP 436A, 438A

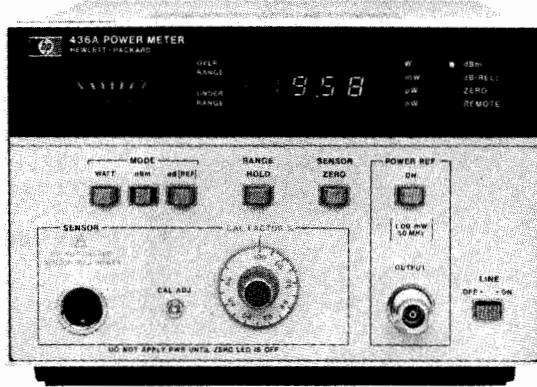

HP 436A



### HP 436A Power Meter

The HP 436A power meter is a general-purpose digital power meter intended for manual and automatic RF and microwave-power measurements. It is compatible with the entire series of HP 8480 thermocouple and diode power sensors.

The HP 436A measures either absolute or relative power. It displays absolute power in either Watts or dBm, and relative power in dB. The HP 436A offers intuitive and straightforward manual operation as well as optional HP-IB programmability (Opt. 022).

#### Specifications

**Frequency range:** 100 kHz to 50 GHz, sensor dependent.

**Power range:** -70 to +44 dBm (100 pW to 25 W), sensor dependent.

#### Accuracy

##### Instrumentation

**Watt mode:**  $\pm 0.5\%$ .

**dBm mode:**  $\pm 0.02$  dB  $\pm 0.001$  dB/degree C.

**dB (REL) model<sup>1</sup>:**  $\pm 0.02$  dB  $\pm 0.001$  dB/degree C.

**Zero:** automatic, operated via front panel switch.

**Zero set:**  $\pm 0.5\%$  of full scale on most sensitive range, typical.

**Zero carry over:**  $\pm 0.2\%$  of full scale when zeroed on the most sensitive range.

**Power reference:** internal 50 MHz oscillator with Type-N female connector on front panel (or rear panel, Opt. 003)

**Power output:** 1.0 mW. Factory set to  $\pm 0.7\%$  traceable to the US National Institute of Standards and Technology.

**Accuracy:**  $\pm 1.2\%$  worst case ( $\pm 0.9\%$  rss) for one year.

#### Supplemental Characteristics

**Recorder output:** linearly proportional to indicated power with 1 volt corresponding to full scale and 0.316 volts to -5 dB; 1 k $\Omega$  output impedance, BNC connector.

**Power consumption:** 100, 120, 220, 240V (+5%, -10%), 48 to 66 Hz, and 360 to 440 Hz; <20 VA (<23 VA with Opt. 022).

**HP-IB function codes:** AH1, C0, DC2, DT0, LE0, PP0, RL2, SH1, SR0, T3, TE0.

**Weight:** net, 4.5 kg (10 lb); shipping, 5.5 kg (12 lb)

**Size:** 134 H x 213 W x 279 mmD (5.2" x 8.4" x 11.0")

#### Accessories

**Furnished:** HP 11730A, 1.5 m (5 ft) power sensor cable; 2.3 m (7.5 ft) power cable.

**Available:** To select and substitute non-standard lengths for power sensor cables, see page 147. HP 5061-9657 rack mount adapter kit (one HP 436A by itself).

#### Ordering Information

HP 436A Power Meter

Opt 003: Reference oscillator output on rear panel only \$0

Opt 004: Delete power sensor cable -\$75

Opt 022: Digital input/output, fully HP-IB compatible \$0

Opt 908: Kit for rack mounting one HP 436A +\$55

Opt 910: Extra operating and service manual +\$25

Opt W30: Extended repair service. See page 723. +\$60

<sup>1</sup>Specifications for within range measurements. For range-to-range accuracy add  $\pm 0.02$  dB.

Price  
\$3,750 ☎

- Ideal for ATE applications
- Dual power sensors
- Innovative ratio & difference measurements



HP 438A



### HP 438A Power Meter

The HP 438A power meter is a dual-channel power meter designed specifically for ATE systems. The compact front panel saves critical rack space, while the dual channel design allows simple and accurate measurements of the ratio and difference of power levels from two separate sensors. This meter is compatible with the HP 8480 series of thermocouple and diode power sensors.

HP-IB capability is standard on the HP 438A. For US Air Force MATE (Modular Automatic Test Equipment) system application, Option 700 provides the HP 438A with the internal capability to be controlled by the MATE language CIIL (Control Interface Intermediate Language).

#### Specifications

**Frequency range:** 100 kHz to 50 GHz, sensor dependent.

**Power range:** -70 to +44 dBm (100pW to 25W), sensor dependent.

Uses HP 8480 series power sensors.

#### Instrumentation accuracy

**Single channel:**  $\pm 0.5\%$  (Watt mode) or  $\pm 0.02$  dB (dBm mode).

**Dual channel:**  $\pm 1\%$  (Watt mode) or  $\pm 0.04$  dB (dBm mode).

**Zeroing:** automatic,  $\pm 0.5\%$  of full scale on most sensitive range.

#### Power reference

**Power output:** 1.00 mW. Factory set to  $\pm 0.7\%$ , traceable to the US National Institute Standards and Technology.

**Accuracy:**  $\pm 1.2\%$  worst case ( $\pm 0.9\%$  rss) for 1 year.

**Connector:** front panel Type-N female (also rear panel Opt 002).

#### Supplemental Characteristics

**Recorder output:** linearly proportional to indicated power in Watts. One volt corresponds to full scale; 1 K $\Omega$  output impedance. BNC rear panel female connector.

**Line voltage:** 100, 120, 220 or 240 Vac +5% -10%. 100 and 120 volts, 48 to 66 Hz and 300 to 440Hz. 220 and 240 volts, 48 to 66 Hz only.

**Power requirements:** 65 VA, 35 Watts, maximum.

**HP-IB interface codes:** SH1, AH1, T5, TE0, L4, LE0, SR1, RL1, PP1, DC1, DT1, C0.

**Weight:** net, 5.9 kg (13 lb). Shipping, 9.1 kg (20 lb).

**Size:** 89 H x 213 W x 418 mmD (3.5" x 8.4" x 16.8").

#### Accessories

**Furnished:** HP 11730A, 2 each, 1.5 metre (5 ft) power sensor cables. Power cable, 1 each, 2.4 meters (7.5 ft). Mains plug matches destination requirements.

**Available:** To select and substitute non-standard lengths for power sensor cables, see page 147.

#### Ordering Information

HP 438A Dual Channel Power Meter

Opt 002: Rear panel sensor connector (in parallel with front panel) and additional reference oscillator with rear panel output.

Opt 700: Internal MATE programming

Opt 004: Delete power sensor cables

Opt 910: Additional manual

Opt W30: Extended repair service. See page 723.

☎ For same-day shipment, call HP DIRECT at 800-538-8787.

Price

\$5,150 ☎

+\$325

+\$1250

-\$150

+\$25 ☎

+\$130

#### HP 435B Power Meter

The HP 435B Power Meter is an analog power meter, compatible with the entire series of HP 8480 Power Sensors. Depending on which sensor is used, the HP 435B can measure power from  $-65$  dBm to  $+44$  dBm, full scale, at frequencies from 100 kHz to 50 GHz. This versatile instrument also features  $<1\%$  instrumentation uncertainty, low noise and drift, auto-zero, recorder output, optional battery operation, and long cable options up to 61 m (200 ft).

#### HP 11683A Range Calibrator

The HP 11683A Calibrator is specifically designed for use with the HP 435B, 436A, 437B, 438A, 70100A and E1416A Power Meters. It allows verification of full-scale meter readings on all ranges, as well as meter tracking. Simply connect the cable between the power meter and calibrator. The CAL ADJ control on the power meter is used to set the meter to full scale on the 1 mW range. The calibrator and meter are then stepped through the other ranges verifying accuracy within  $\pm 1\%$  plus noise and drift. The HP 11683A also has a polarity switch which tests the Auto-Zero circuit.

#### HP 435B Specifications

**Frequency range:** 100 kHz to 50 GHz (sensor dependent).

**Temperature range:**  $0 - 55^{\circ}\text{C}$ .

**Power Range** (calibrated in watts and dB in 5 dB steps).

**With HP 848xB:**  $+5$  dBm (3 mW) to  $+44$  dBm (25 W) full scale.

**With HP 848xH:**  $-5$  dBm (0.3 mW) to  $+35$  dBm (3 W) full scale.

**With HP 848xA:**  $-25$  dBm (3  $\mu\text{W}$ ) to  $+20$  dBm (100 mW) full scale.

**With HP 848xD:**  $-65$  dBm (300 pW) to  $-20$  dBm (10  $\mu\text{W}$ ) full scale.

#### Accuracy

**Instrumentation:**  $\pm 1\%$  of full scale on all ranges.

**Zero:** automatic, operated by front-panel switch.

**Zero set:**  $\pm 0.5\%$  of full scale on most sensitive range, typical.

**Zero carryover:**  $\pm 0.5\%$  of full scale when zeroed on the most sensitive range.

**Power reference:** internal 50 MHz oscillator with Type N female connector on front panel (or rear panel, Option 003 only).

**Power output:** 1.00 mW. Factory set to  $\pm 0.7\%$  traceable to the U.S. National Institute of Standards and Technology.

**Accuracy:**  $\pm 1.2\%$  worst case ( $\pm 0.9\%$  rss) for one year.

#### Supplemental Characteristics

**Recorder output:** linearly proportional to indicated power with 1 volt corresponding to full scale; 1 k $\Omega$  output impedance, BNC connector.

**RF blanking output:** provides a contact closure to ground. Used for turning off RF input to sensor during auto-zeroing. BNC connector.

**Power consumption:** 110 or 120 V ( $+5\%$ ,  $-10\%$ ), 48 to 66 Hz and 360 to 440 Hz; also 220 or 240 V ( $+5\%$ ,  $-10\%$ ), 48 to 66 Hz only;  $<20\text{V} \cdot \text{A}$ .

**Weight:** net, 2.7 kg (5.9 lb). Shipping, 4.2 kg (9.2 lb).

**Size:** 155 H x 130 W x 279 mm D (6.3" x 5.1" x 11").

#### Accessories

**Furnished:** HP 11730A, 1.52 m (5 ft) cable for the power sensor; 2.3 m (7.5 ft) power cable (mains plug shipped to match destination requirements).

#### Available

To select or substitute non-standard lengths for power sensor cables see HP 11730A-F Power sensor cables section.

**HP 5060-8762:** Rack adapter frame (holds three instruments the size of the HP 435B).

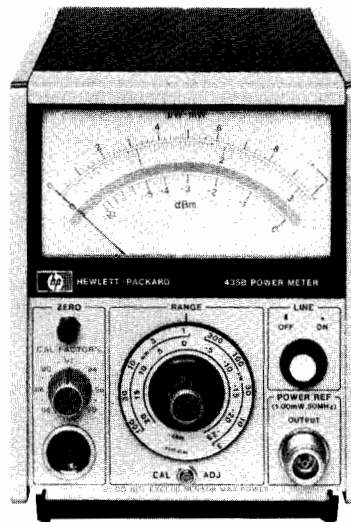

HP 435B

#### HP 11683A Range Calibrator Specifications

**Calibration functions:** outputs corresponding to meter readings of 3, 10, 30, 100 and 300  $\mu\text{W}$ ; 1, 3, 10, 30, and 100 mW.

**Calibration uncertainty:**  $\pm 0.25\%$  in all ranges.

**Power:** 100, 120, 220, or 240 Vac  $+5\%$ ,  $-10\%$ , 48–440 Hz, less than 10 V  $\cdot$  A.

**Weight:** net, 1.13 kg (2.5 lb). Shipping, 1.9 kg (4.2 lb).

**Size:** 89 H x 133 W x 216 mm D (3.5" x 5.25" x 8.5").

#### HP 11730A-F Power Sensor Cables

The HP 11730 series power sensor cables are for use with the HP 435B, 436A, 437B, 438A, 70100A and E1416A power meters and the HP 8480 series of thermocouple and diode power sensors. These cables are designed to reduce RFI effects on low power readings with an improved shielding design in the cable itself. Cables may be ordered individually or in pairs in any combination desired for single and dual-channel measurements.

The HP 11730A cable is the standard cable for the HP 435B, 436A, 437B, 438A (2 cables shipped), 70100A and E1416A meters. To order a non-standard cable, select Option 004 for the meter in question, and order the desired cable from below.

#### Ordering Information

**HP 11683A Range Calibrator**

**Price**

\$1,100

**HP 435B Power Meter**

\$1,700

**Opt 001** Rechargeable battery installed provides up to 16 hours of continuous operation

+\$100

**Opt 002** Input connector placed on rear panel in parallel with front

+\$25

**Opt 003** Parallel sensor inputs front and rear panels, reference oscillator output on rear panel.

+\$25

**Opt 004** Delete power sensor cable

-\$75

**Opt 910** Extra operating and service manual (P/N 00435-90040)

+\$7.50

**W30** Extended repair service. See page 723.

+\$50

**HP 11730A** 1.5 meter (5 ft) sensor cable

\$95

**HP 11730B** 5.0 meter (10 ft) sensor cable

\$105

**HP 11730C** 6.1 meter (20 ft) sensor cable

\$150

**HP 11730D** 15.2 meter (50 ft) sensor cable

\$210

**HP 11730E** 30.5 meter (100 ft) sensor cable

\$280

**HP 11730F** 61.0 meter (200 ft) sensor cable

\$450

☎ For same-day shipment, call HP DIRECT at 800-538-8787.

# POWER METERS

## Power Sensors

HP 8481A/B/D/H, 8482A/B/H, 8483A,  
8485A/D, R/Q 8486A/D, 8487A/D, 11708A

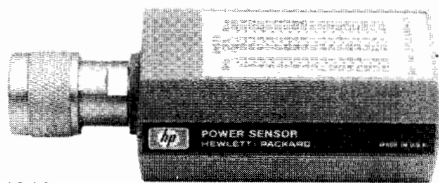

HP 8481A

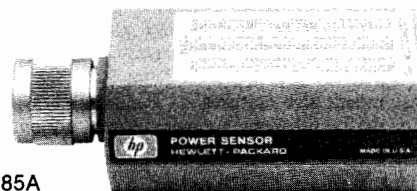

HP 8485A

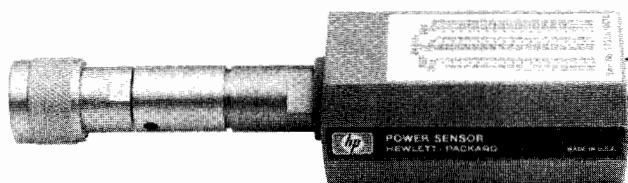

HP 8481H

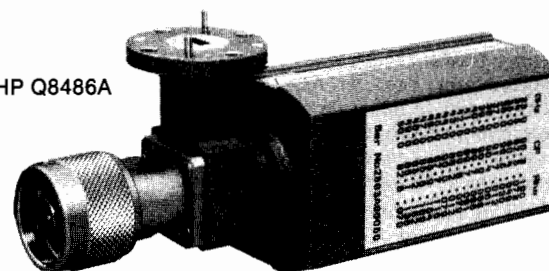

HP Q8486A

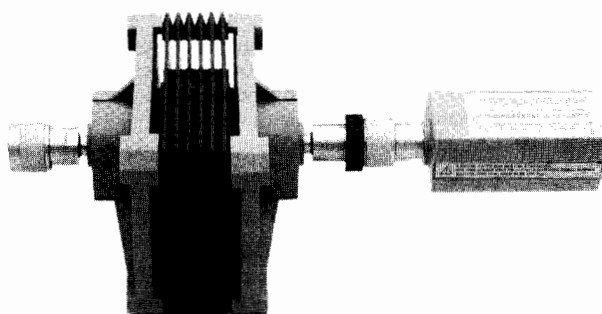

HP 8481B

### HP 8480 Power Sensor Family

The HP 8480 power sensors are designed for use with the HP 435B, 436A, 437B, 438A, 70100A and E1416A Power Meters. These thermocouple and diode power sensors provide extraordinary accuracy, stability and SWR over a wide range of frequencies (100 kHz to 50 GHz) and power levels (-70 to +44 dBm).

#### Best SWR in the Industry

Mismatch uncertainty is usually the largest single source of error in power measurements. The HP 8480 power sensor family gives you extremely low SWR even at mm-wave frequencies. For example, the new HP 8485D high sensitivity power sensor has a specified SWR of less than 1.29:1 over its entire 50 MHz to 26.5 GHz frequency range. This low SWR translates into minimum mismatch uncertainty and optimum measurement accuracy.

#### Accurate Calibration and Traceability

Each power sensor in the HP 8480 family is individually calibrated and traceable to the U.S. National Institute of Standards and Technology (NIST, formerly NBS). The uncertainty in this calibration factor is your link to NIST. The Cal Factor measurement system used by HP Standards Lab provides you with minimum Cal Factor uncertainty.

#### True-RMS Reading Sensors

HP high-sensitivity diode power sensors (HP 8481D/5D/6D/7D) are always operated inside the square-law region. This means that the sensor will act as a true-RMS reading device over its entire -70 to -20 dBm dynamic range. The benefit to you: HP sensors provide you with accurate readings even if your test signal is subjected to multitone environments, modulated carriers, or carriers with high harmonics.

#### mm-Wave Sensor Calibration

A 50 MHz calibration port is included in HP waveguide power sensors for calibration with the power meter. This calibration provides traceability to NIST at millimeter-wave frequencies, and it eliminates the uncertainties due to temperature changes and the variance in making measurements with different meter/sensor combinations.

#### Accurate Accessories Included

With HP power sensors, you can start making measurements right away. No more hunting around for attenuators or adapters. HP sensors include all the accessories you need to optimize accuracy and save time.

#### In-House Power Sensor Calibration

Power sensor calibration is now easier than ever with the new HP 11760S-E01 calibration system, designed specifically for Metrology and Cal Lab engineers. In less than four minutes, this complete sensor calibration system can measure your sensor's Cal Factor, calculate all measurement uncertainties, generate a permanent record for your files, and plot a new replacement Cal Factor label.

For more information on the HP 11760S-E01 Power Sensor Calibration System, please contact your HP Field Engineer.

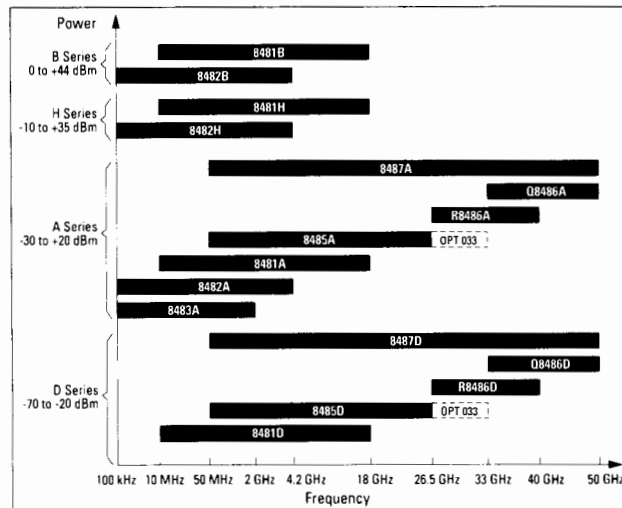

Figure 1. HP 8480 Power Sensor Family frequency and power range coverage.

## HP 8480 Series Specifications

### 25 Watt Sensors 1 mW to 25W (0 to +44 dBm)

HP Model	Frequency Range	Maximum SWR	Power Linearity	Maximum Power <sup>1</sup>	Connector Type	Weight	Price
8481B	10 MHz-18 GHz	10 MHz-2 GHz: 1.10 2-12.4 GHz: 1.18 12.4-18 GHz: 1.28	+35 to +44 dBm ±4%	0-35°C: 30W avg 35-55°C: 25W avg 0.01-5.8 GHz: 500W pk 5.8-18 GHz: 125W pk 500W μs per pulse	N(m)	Net 0.8 kg (1.75 lb) Shipping 1.5 kg (3.25 lb)	\$1,700
8482B	100 kHz-4.2 GHz	100 kHz-2 GHz: 1.10 2-4.2 GHz: 1.18			N(m)		\$1,650

### 3 Watt Sensors 100 μW to 3W (-10 to +35 dBm)

8481H	10 MHz-18 GHz	10 MHz-8 GHz: 1.20 8-12.4 GHz: 1.25 12.4-18 GHz: 1.30	+25 to +35 dBm ±5%	3.5W avg, 100W pk 100W μs per pulse	N(m)	Net 0.2 kg (0.38 lb) Shipping 0.5 kg (1 lb)	\$875
8482H	100 kHz-4.2 GHz	100kHz-4.2GHz: 1.20			N(m)		\$850

### 100 mW Sensors 1 μW to 100 mW (-30 to +20 dBm)

8485A	50 MHz-26.5 GHz	50-100 MHz: 1.15 100 MHz-2 GHz: 1.10 2-12.4 GHz: 1.15 12.4-18 GHz: 1.20 18-26.5 GHz: 1.25	+10 to +20 dBm +2, -4%	300 mW avg, 15W pk 30W μs per pulse	APC-3.5mm (m)	Net 0.2 kg (0.38 lb) Shipping 0.5 kg (1 lb)	\$1,025
Opt. 033	50 MHz-33 GHz	26.5-33 GHz: 1.40					+350
8481A	10 MHz-18GHz	10-30 MHz: 1.40 30-50 MHz: 1.18 50 MHz-2 GHz: 1.10 2-12.4 GHz: 1.18 12.4-18 GHz: 1.28			N(m)		\$700
8482A	100 kHz-4.2 GHz	100-300 kHz: 1.60 0.3-1 MHz: 1.20 1 MHz-2 GHz: 1.10 2-4.2 GHz: 1.30			N(m)		\$700
8483A (75Ω)	100 kHz-2 GHz	100-600 kHz: 1.80 600kHz-2 GHz: 1.18		300 mW avg, 10W pk	N(m) 75Ω		\$700
R8486A	26.5-40 GHz	1.4	+10 to +20 dBm +2, -4%	300 mW avg, 15W pk 30W μs per pulse	Waveguide Flange UG-599/U	Net 0.26 kg (0.53 lb) Shipping 0.66 kg (1.3lb)	\$2,000
Q8486A	33-50 GHz	1.5			Waveguide Flange UG-383/U		\$2,750
8487A	50 MHz-50 GHz	50-100 MHz: 1.15 100 MHz-2 GHz: 1.10 2-12.4 GHz: 1.15 12.4-18 GHz: 1.20 18-26.5 GHz: 1.25 26.5-40 GHz: 1.30 40-50 GHz: 1.50	+10 to +20 dBm +2, -4%	300 mW avg, 15W pk 30W μs per pulse	2.4 mm (m)	Net 0.14 kg (0.28 lb) Shipping 0.5 kg (1 lb)	\$2,150

### High Sensitivity Sensors 100 pW to 10 μW (-70 to -20 dBm)

8481D <sup>3,4</sup>	10 MHz-18 GHz	10-30 MHz: 1.40 30 MHz-4 GHz: 1.15 4-10 GHz: 1.20 10-15 GHz: 1.30 15-18 GHz: 1.35	-30 to -20 dBm ±1%	100 mW avg 100 mW pk	N(m)	Net 0.18 kg (0.41 lb) Shipping 0.9 kg (2 lb)	\$950
8485D <sup>3</sup>	50 MHz-26.5 GHz	0.05-0.1 GHz: 1.19 0.1-4 GHz: 1.15 4-12 GHz: 1.19 12-18 GHz: 1.25 18-26.5 GHz: 1.29	-30 to -20 dBm ±2%	100 mW avg 100 mW pk	APC-3.5 mm (m)	Net 0.2 kg (0.38 lb) Shipping 0.5 kg (1 lb)	\$1,450
Opt. 033	50 MHz-33 GHz	26.5-33 GHz: 1.35					+350
8487D <sup>3</sup>	50 MHz-50 GHz	0.05-0.1 GHz: 1.19 0.1-2 GHz: 1.15 2-12.4 GHz: 1.20 12.4-18 GHz: 1.29 18-34 GHz: 1.37 34-40 GHz: 1.61 40-50 GHz: 1.86	-30 to -20 dBm ±2%	100 mW avg 100 mW pk	2.4 mm (m)	Net 0.2 kg (0.38 lb) Shipping 0.5 kg (1 lb)	\$2,750
R8486D <sup>3</sup>	26.5-40 GHz	1.4	-30 dB to -25 dBm ±3%	100 mW avg or pk 40 Vdc max	Waveguide Flange UG-599/U	Net 0.26 kg (0.53 lb) Shipping 0.66 kg (1.3 lb)	\$2,700
Q8486D <sup>3</sup>	33-50 GHz	1.4	-25 dB to -20 dBm ±5%		Waveguide Flange UG-383/U		\$3,600

1 Negligible deviation except for those power ranges noted.

2 For pulses greater than 30W the maximum average power ( $P_{avg}$ ) is limited by the energy per pulse (E) in W · μs according to  $P_{avg} = 30-0.02E$ .

3 Includes HP 11708A 30 dB attenuator for calibrating against a 0 dBm, 50 MHz power reference. HP 11708A is factory set to 30 dB ±0.05 dB at 50 MHz, traceable to NIST. SWR <1.05 at 50 MHz.

4 This sensor directly replaces the popular HP 8484A Power Sensor.

☎ For same-day shipment, call HP Direct at 800-538-8787.

# POWER METERS

## Thermistor Power Meters & Power Meter Calibrator

HP 432A/B, 8477A

- Automatic zero
- High accuracy

- Recorder outputs, analog & digital
- Long cable options

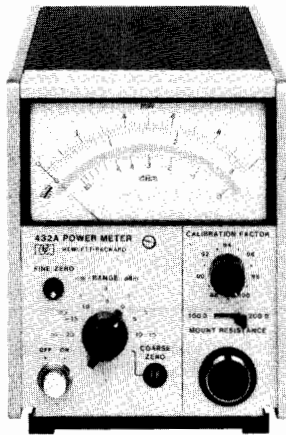

HP 432A



HP 432B

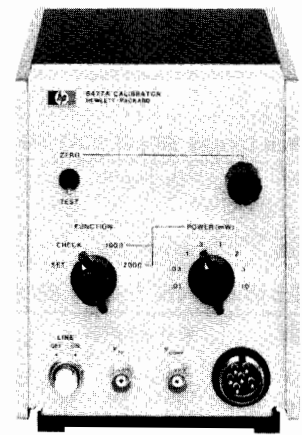

HP 8477A

### HP 432A/B Power Meters

**High accuracy—no thermoelectric error:** high accuracy over a wide temperature range is featured on the HP 432 Power Meters. By measuring the output voltage of the thermistor bridges, and computing the corresponding power, even higher accuracy of  $\pm 0.2\% \pm 0.5 \mu\text{W}$  can be obtained.

Accuracy can be maintained on even the most sensitive range because the error due to thermoelectric effect is reduced to a negligible level.

**Calibrated mounts:** each thermistor mount is furnished with data stating the Calibration Factor\* and Effective Efficiency\* at various frequencies across the operating range. For easy and accurate power measurements, the front panel of the HP 432 contains a calibration factor control, calibrated in 1% steps from 88% to 100%, that compensates for losses in the mount and eliminates the need for calculation.

**Instrument type:** automatic, self-balancing power meter for use with temperature-compensated thermistor sensor.

\*"Calibration Factor" and "Effective Efficiency" are figures of merit expressing the ratio of the substituted signal measured by the power meter to the microwave power incident on and absorbed by the sensor.

### Specifications (partial)

#### Power Range

**HP 432A:** seven ranges with full-scale readings of 10, 30, 100, and 300  $\mu\text{W}$ , 1, 3, and 10 mW; also calibrated in dBm from  $-20$  dBm to  $+10$  dBm full scale in 5 dB steps.

**HP 432B:** four ranges with full-scale readings of 10 and 100  $\mu\text{W}$ , and 1 and 10 mW.

**Noise:** less than 0.25% of full scale peak (typical).

**Response time:** at recorder output, 35 ms time constant (typical).

**Fine zero:** automatic, operated by front panel switch.

**Zero carryover:** less than 0.50% of full scale when zeroed on most sensitive range.

#### Meter

**HP 432A:** taut-band suspension, individually calibrated, mirror-backed scales. Milliwatt scale more than 108 mm (4.25 in.) long.

**HP 432B:** three digits with one digit overrange. 20% overrange capability on all ranges.

**Calibration factor control:** 13-position switch normalizes meter reading to account for thermistor sensor calibration factor. Range 100% to 88% in 1% steps.

**Thermistor sensor:** thermistor sensors are required for operation of the HP 432A/B. For microwave sensors HP 478B, 8478B and 486 series see page 151.

**Recorder output:** proportional to indicated power with 1 volt corresponding to full scale. 1 k $\Omega$  output impedance.

**BCD output:** 8, 4, 2, 1 code: "1" positive. TTL compatible logic. Operates with HP 5150A, Opt 002 (BCD) Digital Recorder. "Print" and "Inhibit" lines available. (HP 432B only.)

#### Power Consumption

**HP 432A:** 115 or 230 Vac  $\pm 10\%$ , 50 to 400 Hz, 1.5 watts.

**HP 432B:** 115 or 230 Vac  $\pm 10\%$ , 50 to 400 Hz, 10 watts.

#### Weight

**HP 432A:** net, 2.3 kg (5.5 lb). Shipping, 4.6 kg (10 lb).

**HP 432B:** net, 3 kg (6.5 lb). Shipping, 4.8 kg (10.5 lb).

**Size:** 130 W x 155 H x 279 mm D (5.2" x 6.1" x 11.0").

### HP 8477A Power Meter Calibrator

The HP 8477A Calibrator is specifically designed for use with the HP 432 Power Meter. It allows you to verify full-scale meter readings on all ranges, and meter tracking. Simply connect three cables between the power meter and calibrator; no charts or additional instruments are required.

**Power:** 115 or 230 Vac  $\pm 10\%$ , 50 to 400 Hz, 3 watts.

### Ordering Information

	Price
HP 432A Power meter	\$1700
HP 432B Power meter	\$2550
Opt 001 rechargeable battery installed, provides up to 20 hours continuous operation (HP 432A only)	+ \$105
Opt 002 input connector placed on rear panel in parallel with front	+ \$25
Opt 003 input connector on rear panel only	+ \$10
Opt 009 3.1 m (10 ft) cable for 110- $\Omega$ or 200- $\Omega$ sensor	+ \$30
Opt 010 6.1 m (20 ft) cable for 100- $\Omega$ or 200- $\Omega$ sensor	+ \$55
Opt 011 15.2 m (50 ft) cable for 100- $\Omega$ or 200- $\Omega$ sensor	+ \$105
Opt 012 30.5 m (100 ft) cable for 100- $\Omega$ or 200- $\Omega$ sensor	+ \$155
Opt 013 61 m (200 ft) cable for 100- $\Omega$ or 200- $\Omega$ sensor	+ \$260
Opt 100 100 Vac operation, 48–66 Hz	\$0
Opt 910 extra operating and service manual (HP432A: P/N 00432-90009) (HP432B: P/N 00432-90053)	+ \$5
Opt W30 Extended repair service. See page 723	+ \$60
HP 8477A Power Meter Calibrator	\$1300
Opt W30 Extended repair service. See page 723	+ \$50

☎ For same-day shipment, call HP Direct at 800-538-8787

## Thermistor Mounts, Peak Power Sensor & Peak Power Meters HP 478A, 8478B, 486 Series, 8900C/D, 84811A

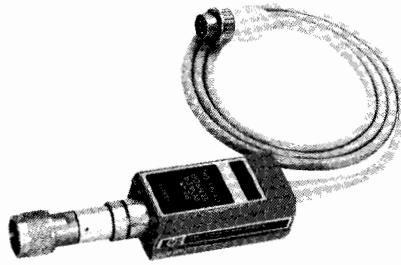

HP 84811A



HP 478A

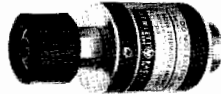

HP 8478B

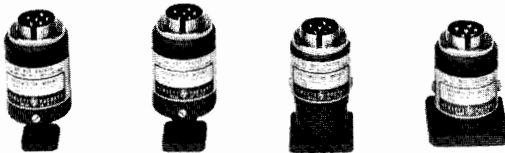

HP 486 Series

### Temperature Compensated Thermistor Mounts

High efficiency and good RF match are characteristic of the HP 478A and 8478B coaxial and 486A series waveguide Thermistor Mounts. Used in conjunction with the HP 432 Power Meter they provide high accuracy even in routine power measurements. These thermistor mounts are temperature-compensated for low drift, even in the presence of thermal shocks, permitting measurement of microwave power as low as one microwatt. Each mount contains data showing Calibration Factor and Effective Efficiency at six frequencies, directly traceable to the U.S. National Institute Standards and Technology at those frequencies where NIST provides calibration service.

### HP 486, 478, 8478B Specifications

HP Model	Frequency range, GHz	Maximum SWR	Operating Resistance (Ohms)	
478A	10 MHz to 10 GHz	1.75, 10 to 25 MHz 1.3, 25 MHz to 7 GHz 1.5, 7 to 10 GHz	200	\$550
8478B <sup>1</sup>	10 MHz to 18 GHz	1.75, 10 to 30 MHz 1.35, 30 to 100 MHz 1.1, 0.1 to 1 GHz 1.35, 1 to 12.4 GHz 1.6, 12.4 to 18 GHz	200	\$700
X486A	8.20 to 12.4	1.5	100	\$800
P486A	12.4 to 18.0	1.5	100	\$950
K486A <sup>2</sup>	18.0 to 26.5	2.0	200	\$950
R486A <sup>2</sup>	26.5 to 40.0	2.0	200	\$950

<sup>1</sup>Option 011: furnished with APC-7 RF connector +\$25  
<sup>2</sup>Circular flange adapters:  
 K-band (UG-425/U) HP 11515A \$325  
 R-band (UG-381/U) HP 11516A \$350

### HP 84811A Peak Power Sensor

The HP 84811A Peak Power Sensor works with the HP 8900C/D Peak Power Meters to measure the peak power of RF pulses. It is supplied with a 4 foot flexible cable to easily reach the pulse source being measured. The HP 84811A also conveniently detaches from the meter for storage, recalibration or replacement.

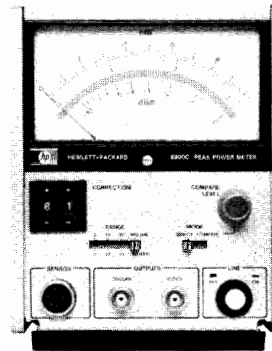

HP 8900C



HP 8900D

### HP 8900C/D Peak Power Meters

The HP 8900C and 8900D Peak Power Meters directly display the peak power of RF pulses over a 100 MHz to 18 GHz frequency range. Measurements can be made on pulses with widths from 1 μs (100 ns in Compare mode) to CW, and repetition rates from 100 Hz (0 Hz in Compare mode) to 100 kHz.

The HP 8900C is an economical analog meter calibrated in watts and dBm. The analog display with its large, easy-to-read scale makes it simple to peak or null pulsed power systems. The HP 8900D has a high resolution 3½ digit digital display calibrated in watts. The direct reading display and range annunciators make the digital version a good choice for production and field applications where unambiguous or frequent readings are required.

### HP 8900C/D Peak Power Meters Specifications

- Frequency range:** 100 MHz to 18 GHz.
- Dynamic range:** 20 dB (0 to +20 dBm).
- HP 8900C:** 4 ranges of 3, 10, 30 and 100 mW full scale.
- HP 8900D:** 2 ranges of 10 and 100 mW full scale.
- Pulse Response:**
  - Direct Mode**
  - Pulse width:** 1 μs to CW.
  - Repetition rate:** 100 Hz to 100 kHz.
  - Compare Mode**
  - Pulse width:** 100 ns (typical) limited by rise time specification.
  - Repetition rate:** 0 to 100 kHz.
  - Rise time:** 75 ns.
  - Fall time:** 125 ns (as measured on video output).

**Power consumption:** 100 and 120 Vac +5, -10%, 48-66 Hz and 360-440 Hz; 220 and 240 Vac +5, -10%, 48-66 Hz.

Meter Accuracy	CW	Pulse	Transfer Accuracy CW to Pulse
Direct	±0.2 dB	±0.35 dB	±0.2 dB
Compare	±0.2 dB	±0.25 dB	±0.1 dB

### HP 84811A Peak Power Sensor Specifications

- Power range:** 0 to +20 dBm (1 mW to 100 mW).
- Frequency range:** 100 MHz to 18 GHz.
- SWR:** 100 MHz to 12 GHz < 1.5. 12 GHz to 18 GHz < 2.0.
- Maximum peak power:** +24 dBm (250 mW) for 5 minutes.
- Connector type:** N (male).
- Calibration:** every 2 GHz from 2 to 10 GHz. Every 1 GHz from 11 to 18 GHz.
- Operating temperature:** 0 to +55°C.
- Calibration accuracy:** (+10 to +40°C), ±0.7 dB 0.1 to 12 GHz. ±1.0 dB to 18 GHz. 0-10°C and 40-55°C: add ±0.2 dB.

### Ordering Information

- HP 8900C Analog peak power meter \$2,750
- HP 8900D Digital peak power meter \$3,300
- Opt W30 Extended repair service (for HP 8900C/D). + \$50

See page 723.

- HP 84811A Peak power sensor \$1,000

☎ For same-day shipment, call HP Direct at 800-538-8787.

# SIGNAL ANALYZERS

## General Information

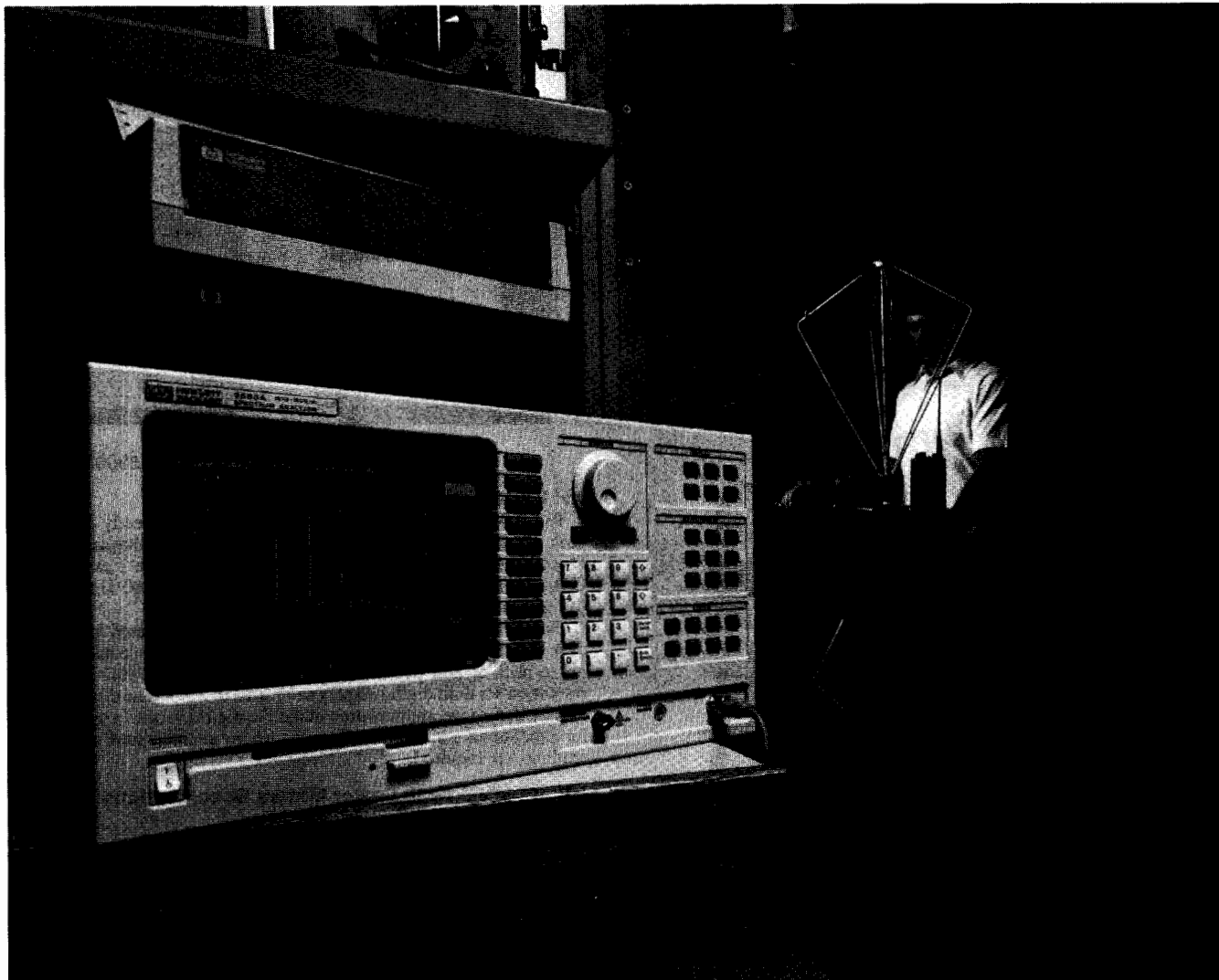

HP has a complete line of signal analyzers to provide frequency domain measurement capability. These include spectrum analyzers, distortion analyzers, audio analyzers, modulation analyzers, and measuring receivers. Each type of instrument has distinctive capabilities that make it the preferred instrument for a particular measurement application.

The spectrum analyzer is a swept-tuned, superheterodyne receiver that provides a CRT display of amplitude versus frequency. It is essentially a frequency-selective, peak-responding voltmeter calibrated to display the RMS value of a sine wave. The spectrum analyzer can show the individual frequency components that make up a complex signal. (It does not provide phase information about a signal, however). The swept receiver technique used in Hewlett-Packard spectrum analyzers enables frequency domain measurements to be made over a large dynamic range and a wide frequency range of 5 Hz to 325 GHz.

The Fourier analyzer uses digital sampling and mathematical transformation techniques to form a Fourier spectrum of a signal. This

method is presently useful for measuring signals from a few  $\mu\text{Hz}$  to 100 kHz and provides frequency, amplitude, and phase information. Like the spectrum analyzer, all information is presented on a CRT display. With its real-time signal analysis capability, the Fourier analyzer is able to capture periodic as well as random and transient events.

The wave analyzer uses a tunable filter, which can be visualized as a movable frequency window, to measure both the amplitude and frequency of individual spectral components. This measurement technique essentially makes the instrument a frequency-selective voltmeter. The wave analyzer employs meters and digital displays to show both the amplitude and frequency of the signal within the window. HP wave analyzers provide accurate results from 15 Hz to 32.5 MHz.

Distortion analyzers and audio analyzers employ broadband detectors and notch filters to measure signal properties such as total harmonic distortion. These tunable filters enable the analyzer to selectively display the level and frequency of harmonic and distortion products. Measurement results are shown on a meter or digital display. Audio analyzers include a signal source, making

possible measurements such as SINAD that include signal and distortion levels. The frequency range covered by HP distortion and audio analyzers extends from 5 Hz to 600 kHz.

Modulation analyzers are designed to capture and analyze a fundamental signal and its entire modulation envelope. These analyzers use independent AM and FM detection circuits for simultaneous analysis of complex modulated signals. When a modulation analyzer is combined with a measuring receiver, accurate measurements of frequency, power, and modulation characteristics can be made on signals from 150 kHz to 26.5 GHz. All measurement results are presented on a digital display.

### Spectrum Analyzers

Spectrum analyzers take advantage of the frequency-conversion properties of the swept-tuned heterodyne receiver to make significant contributions to frequency-domain signal analysis. The following are some of the measurements that can be made with spectrum analyzers:

- 1) Absolute and relative frequency.
- 2) Absolute and relative amplitude.



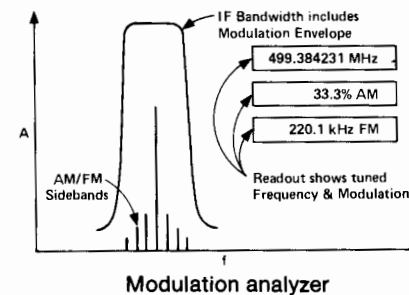
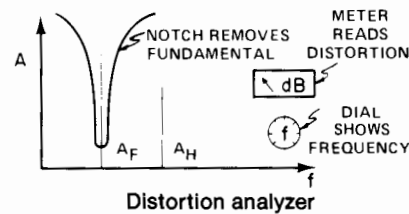
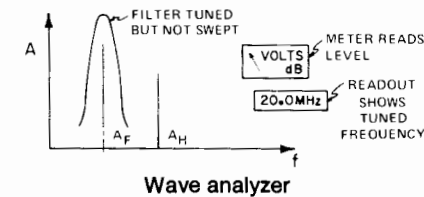
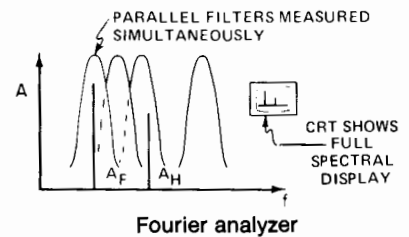
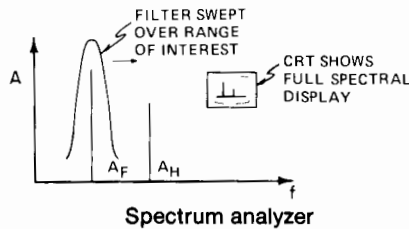
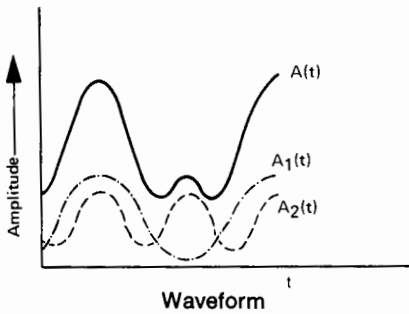

These measurements are possible because spectrum analyzers have the following characteristics:

- 1) Broad frequency coverage from 5 Hz to 325 GHz.
- 2) Wide amplitude range from -138 dBm to +30 dBm.
- 3) Excellent sensitivity for low-signal detection.
- 4) Excellent frequency stability.
- 5) High resolution of frequency and amplitude.

These capabilities allow spectrum analyzers to provide frequency-domain signal analysis for numerous applications, including the manufacture and maintenance of microwave communication links, radar, telecom equipment, CATV systems, and broadcast equipment; EMI diagnostic testing; and signal surveillance.

In addition to the swept-tuned frequency mode, spectrum analyzers can also be used in the fixed-tuned mode (zero span) to provide time-domain measurement capability much like that of an oscilloscope.

With the addition of desktop technical computers, the capability of spectrum analyzers can be greatly enhanced. Computers can be used to directly control the operation of spectrum analyzers over HP-IB. Computers can also be used to develop downloadable programs (DLPs) for those spectrum analyzers with the capability to store such programs in non-volatile memory. These custom measurement routines are then as easy to use as any of the standard instrument features.

In addition, spectrum analyzers with HP-IB capability can directly control a plotter or printer, enabling a hard copy of the CRT display to be made without the use of a computer. Application areas that require accurate, high speed, repetitive routines; physical separation of the operator and the analyzer; unattended operation or operation by personnel with limited technical skills—all are candidates for automation.

Areas that benefit significantly from automated spectrum analysis include

- 1) EMC testing,
- 2) frequency spectrum monitoring,
- 3) production testing of RF or microwave components, subsystems, or systems, and
- 4) remote site testing.

The basic measurement capabilities of the spectrum analyzer, combined with its ability to automate and to interface with other HP-IB instruments and peripherals, make this instrument ideal for many general-purpose and specialized applications.

### Fourier Analyzers

Fourier analyzers offer fast, high-resolution spectrum and network analysis. Unlike conventional swept analyzers, Fourier-based analyzers can measure dynamic signals because they measure all frequencies simultaneously, not one at a time.

Fourier analyzers characterize signals using digital signal processing techniques based on the Discrete Fourier Transform. For a complete description of these techniques, see Application Note 243, "The Fundamentals of Signal Analysis."

Fourier analyzers are especially useful on low frequency signals (<100 kHz) or where very fast measurements are desired. They can improve measurement speed by a factor of 10 to 100 and allow accurate measurements on frequencies as low as a few microHertz. Signal components as closely spaced as 20 microHertz can be clearly resolved and accurately measured.

Since both magnitude and phase of each frequency component are measured, the Fourier analyzer can measure the statistical properties of signals or the joint properties or relationships of two or more signals. Applications include acoustic, modal, vibration or rotating machine analysis. In addition, various types of modulation can be detected and measured.

Simultaneous measurement of magnitude and phase on two or more channels provides high quality network measurements. Transfer functions or frequency response can be easily measured and the use of band-limited or band-translated random noise as the stimulus allows the entire frequency span of interest to be measured at once. Measurement of the coherence function can provide an indication of the validity of many network measurements.

### Wave Analyzers/SLMs

Wave analyzers are known by several different names: frequency selective voltmeters, carrier frequency voltmeters, and selective level meters. A wave analyzer can be thought of as a finite bandwidth filter which can be tuned throughout a particular frequency range. Signals will be selectively measured as they are isolated within the bandwidth of the filter. For a particular signal, the wave analyzer will indicate both its frequency and amplitude.

The uses of wave analyzers can be categorized into three broad areas: (1) amplitude measurement of a single component of a complex frequency system, (2) amplitude measurement in the presence of noise and interfering signals, and (3) measurement of signal energy appearing in a specified, well-defined bandwidth.

Wave analyzers are most commonly used in communication systems and have input configurations and measurement bandwidths optimized for these applications. Both balanced and unbalanced inputs are available and impedances range from 50 Ohms to 600 Ohms.

### Distortion, Audio Analyzers

The Hewlett-Packard distortion and audio analyzers consist of a narrow band rejection filter and broadband detector. Before the fundamental is rejected, the analyzer first measures the amplitude of the fundamental, all the harmonic components, and noise. Then the rejection filter is employed to remove the fundamental. The ratio of the two measurements is total harmonic distortion plus noise.

- 3) Noise.
- 4) Distortion products.
- 5) AM, FM & pulsed RF modulation.
- 6) Stimulus response.
- 7) Electromagnetic compatibility (EMC).

# SIGNAL ANALYZERS

## General Information

### Audio Analyzers

The audio analyzer performs several basic low frequency measurements in addition to distortion, making it a general purpose audio test set. The audio analyzer includes the SINAD function for testing mobile radio receiver sensitivity. It contains a low distortion audio oscillator for stimulus response testing in combination with its distortion analyzer. It has a true rms voltmeter and dc voltmeter for accurate measurement of complex waveform levels. Swept ac level and swept distortion measurements can be made using the internal source and rms voltmeter. A reciprocal frequency counter is included that continuously counts the frequency of the input signal.

### True Harmonic Distortion Measurements

Computer-controlled spectrum analyzers provide a rapid means of measuring true harmonic distortion levels. The fundamental and its harmonic components are rapidly measured one at a time and the distortion is computed and either stored or printed.

### Modulation Analyzers/Measuring Receivers

A modulation analyzer is a precision receiver designed to detect the entire modulation envelope of a signal under test. It can

measure and display the carrier characteristics of RF frequency and power as well as AM, FM and phase modulation characteristics such as AM depth, peak deviation, residual modulation, and various associated ratios. The modulation analyzer faithfully recovers the actual modulation signal for further analysis such as distortion testing.

In addition to having all the capabilities of the modulation analyzer, the measuring receiver can measure power down to -127 dBm. With very high accuracy, it can look at signals up to millimeter-wave frequencies. This makes it ideal for calibration of signal generators and attenuators.

### Microwave Modulation Analyzers

Most modern microwave communication and radar/EW system designers are turning to the use of complex modulations to improve performance and make them less susceptible to dense signal environments. This typically involves the use of quadrature or "vector" modulation formats such as QPSK or 16QAM in the case of communication systems and complex, coded formats in the case of radar/EW systems.

In all of these receivers, the signal processing is not handled in the traditional one-channel, amplitude-only mode, but instead is

demodulated into in-phase and quadrature-phase signals that provide dynamic phase and amplitude information about the carrier's modulation, and thus enhances system performance.

The high bandwidth requirements of those modulations combined with the need to measure and characterize both the amplitude and phase of the signals has led to the introduction of the HP 8980A Vector Analyzer and the HP 8981A Vector Modulation Analyzer. Both instruments contain a matched dual channel, sampling oscilloscope with dc to 350 MHz baseband capability. Powerful measurement routines and tailored screens make modulation measurements simple and fast. Routines will measure such parameters as quadrature error, lock angle, constellation closure, gain matching, and dc offsets.

The HP 8981A contains an internal I/Q demodulator that takes an IF signal from 50 MHz to 200 MHz and demodulates it into I and Q signals for display and analysis. A user-configured down-converter can be used to analyze microwave signals. Extensive application information is available in Application Notes 343-2, 343-3, and 343-4, as well as in related data sheets and product notes.

## Signal Analyzer Selection Guide

### Dynamic Signal Analyzers

Frequency Range	Frequency Accuracy ( $\pm$ ) <sup>1</sup>	Resolution Bandwidth Range	Average Noise Level (narrowest RBW)	Optimum Dynamic Range 2nd/3rd Order	Amplitude Accuracy (+) <sup>2</sup>	HP Model Number	Page
.000125 Hz - 100 kHz	3 Hz	23 $\mu$ Hz - 900 Hz	-120 dBv	85 dB/85 dB	.15 dB	HP 3561A	157
.000064 Hz - 100 kHz	4 Hz	12 $\mu$ Hz - 450 Hz	-116 dBv	85 dB/85 dB	.15 dB	HP 3562A HP 3563A	161
.000244 Hz - 102.5 kHz	3 Hz	244 $\mu$ Hz - 920 Hz	-140 dBv	75 dB/75 dB	.5 dB	HP 35660A	168
0.0625 Hz - 40 kHz	8 Hz	625 $\mu$ Hz - 1440 Hz		60 dB/60 dB	.5 dB	HP 3560A	156
0.000244 Hz-102.4 kHz	3 Hz	644 $\mu$ Hz - 920 Hz	-140 dBu	78 dB/78 dB	.5 dB	HP 35665A	160, 159

### Spectrum Analyzers

Frequency Range	Frequency Accuracy ( $\pm$ ) <sup>1</sup>	Resolution Bandwidth Range	Average Noise Level (narrowest RBW)	Optimum Dynamic Range 2nd/3rd Order	Amplitude Accuracy ( $\pm$ ) <sup>2</sup>	HP Model Number	Page
20 Hz - 40.1 MHz	40 Hz	3 Hz - 30 kHz	-137 dBm	105 dB/86 dB	.4 dB	HP 3585B	169
10 Hz - 150 MHz	150 Hz	.004 Hz - 17 kHz	-132 dBm	80 dB/80 dB	.3 dB	HP 3588A	171
10 kHz - 1500 MHz	5 kHz <sup>3</sup>	1 kHz - 3 MHz	-115 dBm	72 dB/83 dB	2 dB	HP 8567A	184
100 Hz - 1500 MHz	260 Hz <sup>3</sup>	10 Hz - 3 MHz	-135 dBm	88 dB/97 dB	2 dB	HP 8568B	184
9 kHz - 1800 MHz	5 MHz <sup>3</sup>	1 kHz - 3 MHz	-115 dBm	70 dB/80 dB	2 dB	HP 8590B	174
9 kHz - 1800 MHz	2 kHz <sup>3</sup> (210 Hz w/PFR)	1 kHz - 3 MHz	-115 dBm	70 dB/80 dB	2 dB	HP 8591A	176
50 Hz - 2.9 GHz +mm	2 kHz <sup>3</sup> (150 Hz w/PFR)	10 Hz - 2 MHz	-130 dBm	81 dB/90 dB	2 dB	HP 8560A <sup>4</sup>	179
100 Hz - 2.9 GHz +mm +lightwave	110 Hz <sup>3</sup>	10 Hz - 300 kHz (3 MHz option)	-134 dBm (-156dBm option)	82 dB/92 dB	2 dB (.75 dB) <sup>5</sup>	HP 71100C <sup>4</sup>	189
50 Hz - 6.5 GHz + mm	2 kHz <sup>3</sup> (150 Hz w/PFR)	10 Hz - 2 MHz	-131 dBm	81 dB/90 dB	2 dB	HP 8561B <sup>4</sup>	179
9 kHz - 22 GHz (25 GHz)	10 MHz <sup>6</sup> (1.8 MHz w/COMB)	1 kHz - 3 MHz	-102 dBm	92 dB/71 dB	3 dB	HP 8592B <sup>4</sup>	174
9 kHz - 22 GHz (26.5 GHz)	20 kHz <sup>6</sup> (1.2 kHz w/PFR)	1 kHz - 3 MHz	-102 dBm	92 dB/71 dB	3 dB	HP 8593A <sup>4</sup>	176
9 kHz - 22 GHz (26.5 GHz) + mm	20 kHz <sup>6</sup> (1 kHz w/PFR)	100 Hz - 2 MHz	-110 dBm	100 dB/78 dB	3 dB	HP 8562A	179
9 kHz - 22 GHz (26.5 GHz) + mm	1 kHz <sup>6</sup>	10 Hz - 2 MHz	-120 dBm	105 dB/85 dB	3 dB	HP 8563A <sup>4</sup>	179
100 Hz - 22 GHz + mm	2.5 kHz <sup>6</sup>	10 Hz - 3 MHz	-125 dBm	107 dB/86 dB	2.7 dB	HP 8566B	184
50 kHz - 22 GHz (26.5 GHz) + mm	1 kHz <sup>6</sup>	10 Hz - 300 kHz (3 MHz option)	-125 dBm (-109 dBm) <sup>7</sup>	70 dB/88 dB (84 dB/91 dB) <sup>7</sup>	2 dB (.75 dB) <sup>5</sup>	HP 71200C <sup>4</sup>	189
100 Hz - 22 GHz + mm + lightwave	1 kHz <sup>6</sup>	10 Hz - 3 MHz	-136 dBm (-153 dBm option)	96 dB/98 dB	2.5 dB (.75 dB) <sup>5</sup>	HP 71210C <sup>4</sup>	189

<sup>1</sup>One-year aging; settlability and temperature dopr drift included. <sup>2</sup>Relative accuracy = relative frequency response + lesser of either scale or fidelity or IF gain accuracy. <sup>3</sup>CF = 1 GHz. <sup>4</sup>For special applications or general export, a modified version is available that does not tune beyond 18 GHz nor span greater than 2.3 GHz. <sup>5</sup> $\pm$ 0.75 dB transfer accuracy using HP 70100A-H01 modular power meter. <sup>6</sup>CF = 10 GHz. <sup>7</sup>HP 71200C with HP 70600A preselector enabled. <sup>8</sup>Unpreselected system unless otherwise noted.

### Wave Analyzers/Selective Level Meters

Frequency Range	Selective Bandpass	Dynamic Range		Freq. Readouts	Type of Inputs	Type of Outputs	Modes of Operation	HP Model Number	Page
		Absolute	Relative						
15 Hz to 50 kHz	3 Hz 10 Hz 30 Hz 100 Hz 300 Hz	0.1 $\mu$ V-300 V full scale	>85 dB	LED 1 Hz Resolution	Banana Jacks	rec: 5 V full scale, with pen lift BFO, Local Oscillator, tuning loudspeaker, and headphone jack	AFC, normal, BFO	3581A/ 3581C	202
50 Hz to 32.5 MHz	20 Hz 400 Hz 3100 Hz	-130 to +20 dBm	>80 dB	LED, 0.1 Hz Resolution	50/75 $\Omega$ BNC 600 $\Omega$ Banana Jacks	Tracking Generator Audio/Loud Speaker 1 MHz Ref.	Wideband Selective USB/LSB	3586C (3336C*)	202 447
50 Hz to 32.5 MHz	20 Hz 400 Hz 3100 Hz WTD	-130 to +20 dBm	>70 dB	LED 0.1 Hz Resolution	75 $\Omega$ BNC/WECO 124 $\Omega$ WECO 135 $\Omega$ WECO 150 $\Omega$ Siemens 600 $\Omega$ WECO/ Siemens	Tracking Generator Audio/Loud Speaker 1 MHz Ref.	Wideband Selective USB/LSB	3586A/B (3336A/B*) (3335A)	554 447

\*Tracking Synthesizers.

### Distortion/Audio Analyzers

Fundamental Frequency Range	Minimum Distortion	Auto Set Level	Auto Nulling	True RMS	AM Detector	Filters	HP Model No.	Internal Source	HP-IB	Page
5 Hz to 600 kHz	0.03% (-70 dB)		•		•	•	334A			203
			•		•	•	334A Opt 002			203
10 Hz-110 kHz	0.0018% (-95 dB)	•	•	•	•	•	339A	•		207
20 Hz-100 kHz	0.01% (-80 dB)	•	•	•	Note 1	•	8903B*	•	•	207
20 Hz-100 kHz	0.01% (-80dB)	•	•	•	Note 1	•	8903E**		•	207

\*The HP 8903B also performs Frequency Count, Signal/Noise, SINAD, watts, ac/dc voltage measurements.

NOTE 1: The HP 8901A Modulation Analyzer (page 00.00) provides complete demodulation of AM, FM, and  $\phi$ M signals. \*\*The HP 8903E also performs Frequency Count, SINAD, and ac/dc voltage measurements.

### Modulation Analyzers/Measuring Receivers

Frequency Range	Modulation Measurements	Amplitude Measurement Range	Audio Frequency Count + Distortion Measurement	HP Model Number	Page
dc to 350 MHz	Baseband AM, $\phi$ M	5mV to 5V	No	8980A	206
dc to 350 MHz 50 to 200 MHz	Baseband IF	5mV to 5V -5 to -20 dBm	No	8981A	206
150 kHz-1300 MHz	AM, FM, $\phi$ M	+30 to 0 dBm	No	8901A	207
150 kHz-1300 MHz	AM, FM, $\phi$ M	+30 to -20 dBm	Yes	8901B	207
150 kHz-1300 MHz	AM, FM, $\phi$ M	+30 to -127 dBm	Yes	8902A	211
150 kHz - 18 GHz or 26.5 GHz	AM, FM, $\phi$ M	+30 to -100 dBm	Yes	8902S	215

### Carrier Phase Noise Analysis

Frequency Range	HP Model Number	Maximum Sensitivity dBc/Hz (depends on offset & method)	Functions Available	Page
5 MHz-18 GHz	3048A Phase Noise Measurement System	-170 dBc/Hz (Requires external reference source of equivalent performance)	Fully documented Software with specified Phase Detector, Frequency Discriminator, AM and Two Port Measurements	204

# SIGNAL ANALYZERS

## Portable Dual-Channel Dynamic Signal Analyzer 31.25 mHz to 40 kHz

HP 3560A

- Frequency response, spectrum, transient analysis in the field
- 8 hr (typical) operation on rechargeable battery pack
- Lightweight (3.2 kg / 7 lbs) and portable
- FFT speed <50 ms for 1024 point complex FFT.
- Octave (full and one-third) and spectral map displays
- On-line zoom for greater resolution at high frequencies



HP 3560A



### HP 3560A Portable Dynamic Signal Analyzer

The HP 3560A portable dynamic signal analyzer is an FFT-based instrument capable of measuring time domain and frequency signals from both steady state and quickly changing signal sources. With two input channels, the HP 3560A provides a variety of frequency response measurements with a frequency range from 31.25 mHz to 40 kHz. Battery power and light weight allow you to bring this broad range of measurements anywhere they are needed with fully portable operation.

The HP 3560A provides more than raw measurements. The ICP input mode directly powers accelerometers, so external signal conditioning hardware is not required. Octave measurements, spectral map displays and marker functions make the HP 3560A a powerful, portable measurement and analysis tool.

#### Ultra-portable dual-channel measurements

The internal, rechargeable battery pack permits the HP 3560A to make spectrum and frequency response measurements in the field. The HP 3560A is built to withstand the harsh environmental conditions normally encountered in portable applications. With a 3.2 kg (7 lb) total weight, the HP 3560A can be taken virtually anywhere.

#### Troubleshoot noise and vibration problems

Analysis features provide the power needed to isolate mechanical noise and vibration signal sources. Octave measurements allow standard acoustic techniques to be used in characterizing the desired signals. The octave measurements comply with ANSI S1.11 standard frequency bands and filter shapes.

Spectral map displays allow you to view your signal and how it changes as a function of time. Spectral map displays are essential for rotating machinery applications where vibration varies as a function of the machine's operating speed.

The spectral map display, combined with the external sampling capability of the HP 3560A, makes it easy to determine which vibration signals are related to the operating speed of the machine and which are fixed frequency signals due to other vibration modes such as structural resonances or oil whirl.

The dual-channel HP 3560A offers structural analysis in the field when used with HP 35207A and 35208A hammer kits. Variable block size, combined with variable frequency span and on-line zoom, provide the tools for data collection and viewing of FRFs when using impact test techniques. Coherence measurements and real/imaginary trace coordinates allow powerful structural analysis.

#### Documentation and analysis

The HP 3560A measurements can be printed on HP QuietJet or HP LaserJet printers, or HP-GL plotters via RS-232. Stored data can also be transferred to a computer via RS-232 and is compatible with Hewlett-Packard's SDF (Standard Data Format) which allows data transportability to other Hewlett-Packard dynamic signal analyzers such as the HP 3566A/3567A and HP 35665A, and third-party analysis packages for data analysis, comparisons and archiving.

#### Specification Summary

##### Frequency

**Measurement range:** 31.25 mHz to 40 kHz with alias protection  
**Spans:** 50 Hz to 20 kHz in 1,2,5 sequence and 40 kHz.

**Resolution:** frequency span / lines

**Number of Lines:** selectable 101, 201, 401, 801, 1601 lines

**Block size:** 256, 512, 1024, 2048, 4096 points

**Windows:** Hann, Flat Top, Uniform

**Amplitude** (50 Hz to 20 kHz spans)

**Accuracy:**  $\pm (0.5 \text{ dB} + 0.025\% \text{ of full scale})$

**Dynamic range:** 70 dB spurious, (0-70% of span) 60 dB THD

**Frequency response channel match** (50 Hz to 20 kHz spans)

**Amplitude:**  $\pm 0.2 \text{ dB}$  0-80% of span

**Phase:**  $\pm 5 \text{ degree}$  0-80% of span

##### Input

**Range:** 5 mV to 5 V full scale in 1,2,5 sequence

**Coupling:** ac, dc, ICP current source, engineering units, integration, differentiation

**Impedance:** 1 M $\Omega$

##### Trigger

**Source:** internal (Ch 1 or 2), external, free run

**Level:** variable slope and level with 1% resolution

**Pre-trigger delay:** 0 to 4096 points

**Post-trigger delay:** 0 to 4096 points

##### External sample

**Maximum frequency:** 102.4 kHz, TTL input

**Averaging:** time, RMS, exponential RMS, peak hold

##### Displays

Time record, power spectrum, power spectral density, frequency response, 1/3 octave, 1/1 octave, CH1-CH2 time, map (2 to 99 traces on display), cross correlation, coherence

##### Display coordinates

Linear magnitude, log magnitude, phase, real, imaginary. Linear x-axis, log x-axis, orders

##### Data storage

Non-volatile storage of 500 state/trace combinations with 200 line spectra

##### General

**Power:** Internal battery power

**Recharger:** 100/120 Vac +5%, -10%, 48-66 Hz 220/240 Vac +5%, -10%, 48-66 Hz.

**Weight:** approximately 3.2 kg (7 lbs)

**Size:** 300H x 210W x 95mmD (11.75" x 8.25" x 3.75")

**Interface:** EIA-232D

##### Environmental

Operating Non-operating

**Temperature** 0 to +40°C -20 to +50°C

**Relative Humidity** 15% to 95%

**Altitude** 4600 m (15,000 ft) 15,000 m (50,000 ft)

##### Accessories

###### Microphones

HP 35220A Free field, standard sens., 5 Hz to 40 kHz,

35 - 160 dB

HP 35221A Free field, high sens., 5 Hz to 20 kHz,

20 - 145 dB

HP 35222A Pressure, standard sens., 5 Hz to 20 kHz, 35 - 160 dB

HP 35223A Pressure, high sens., 5 Hz to 10 kHz,

20 - 145 dB

HP 35224A Pre-amplifier, 2 Hz to 200 kHz,  $\pm 0.5 \text{ dB}$

HP 35228A Microphone power supply (battery)

HP 35229A 94 dB/104 dB, 1 kHz calibrator

###### Accelerometers

HP 35200A general vibration; 10 mV/g, 1 Hz to 9 kHz

HP 35201A machinery vibration; 50 mV/g, 1 Hz to 3 kHz

#### Ordering Information

HP 3560A Portable dynamic signal analyzer

Opt 1BH General export license version

#### Price

Contact  
Hewlett  
Packard

- Spectrum analysis,  $1/3$  and  $1/1$  octave analysis
- Time capture (40 k sample)
- High speed (7.5 kHz real time rate)

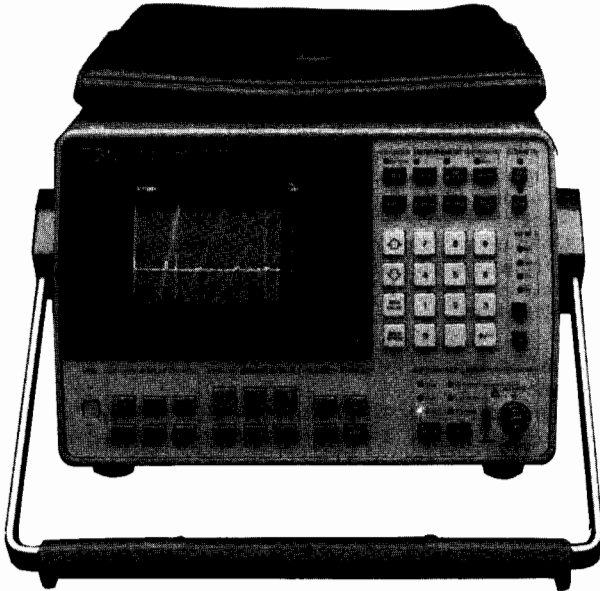

### Providing High-Performance Signal Analysis

If your test and measurement applications require the performance of a lab instrument with transportable convenience, the HP 3561A is ready to go to work for you. It provides 80 dB dynamic range with  $\pm 0.15$  dB amplitude accuracy, giving you the precision needed to isolate small components in a signal.

The HP 3561A's set of measurement functions lets you approach problems from several different angles. Spectra can be displayed in a variety of formats and units, including a three-dimensional spectral map. This map displays up to 60 successive spectra and is extremely useful for analyzing transients and monitoring dynamic signals in both electronic and mechanical systems.

In addition to spectrum measurements, the HP 3561A displays time waveforms, and you can observe a signal in both the time and frequency domains simultaneously. A 40 ksample time buffer captures transients for later measurements and analysis. And this instrument is an excellent choice for acoustics measurements, with its  $1/3$  and  $1/1$  octave measurements, together with the built-in analog A-weighted filter.

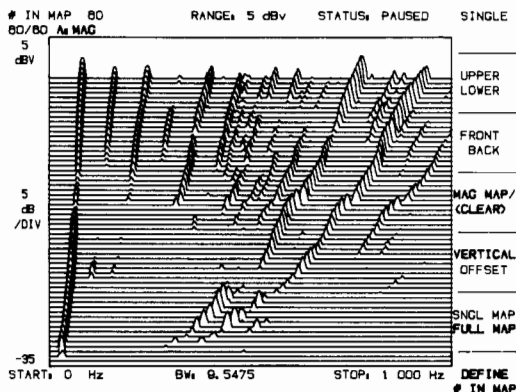

Spectral maps greatly reduce the time required to analyze changes in up to 60 successive measurements.

- High accuracy,  $\pm 0.15$  dB
- 80 dB dynamic range, to 640  $\mu$ Hz resolution bandwidth
- Non-volatile memory option stores 127 measurements

### Solutions in Spectrum Analysis

The HP 3561A gives you the tools for fast, efficient spectrum analysis. In addition to standard marker features, such as marker-to-peak and peak tracking, it provides harmonic analysis with automatic computation of THD in either percent or dB. Band markers quickly compute rms band level or average band power. Sideband markers make it easy to identify the frequency spacing of modulation sidebands and automatically compute the power.

### Solutions in Vibration and Acoustics

When used with an accelerometer or other motion transducer, the HP 3561A is an excellent diagnostic tool for vibration analysis. By using the display marker capabilities, you can quickly deduce the cause of many machine vibration problems. For acoustics measurements, the octave displays update quickly to indicate short-term changes in noise level. And calibrated sound pressure level measurements are possible with the simple engineering units feature.

### Specifications

#### Frequency

**Range:** 0.000125 Hz to 100 kHz.

**Accuracy:**  $\pm 0.003\%$  of display center frequency.

**Resolution:** 0.25% of frequency span.

**Window:** flat top, Hann, uniform, and exponential

**Real-time bandwidth:** (typical) single display, 3 kHz. Fast average display, 7.5 kHz.

#### Amplitude

**Measurement range:** +27 to -120 dBV noise floor (22.4 Vrms to 1  $\mu$ V noise floor).

**Dynamic range:** 80 dB

**Accuracy at the passband center**

$\pm 0.15$  dB  $\pm 0.015\%$  of input range +27 to -40 dBV input ranges

$\pm 0.25$  dB  $\pm 0.025\%$  of input range -41 to -51 dBV input ranges

#### Input

**Impedance:**  $1 \times 10^6 \Omega \pm 5\%$  shunted by 95 pF maximum

**Isolation:** input low may be connected to chassis ground or floated up to 30 volts rms (42 volts peak) above ground

**Coupling:** signal may be ac or dc coupled. Low frequency 3-dB point < 1 Hz in ac mode.

**ICP current:** nominal 4 mA current source provided

#### Output

**Source:** pseudo-random, random, or impulse

#### Display

**General:** magnitude, phase, time and math traces can be selected. Units available are:

**Horizontal:** Hz, seconds, RPM, orders; linear, or log spacing

**Vertical:** dBV, dBm (selectable Z), volts, volts squared, and user-defined units

**Math:** Arithmetic operations can be performed on new or recalled frequency spectra. Add, subtract, multiply, divide, integrate, differentiate and user-defined constants are provided. 1/BW is provided for Power Spectral Density (PSD) computations.

#### Internal Memory

	Non-volatile	Volatile
<b>Standard</b>	2 traces, 6 states	40 time records
<b>Optional</b>	traces + states + (1+2x time records) = 127	40 time records

#### General

**Weight:** net, 15kg (33lb); shipping, 21.6kg (47.5lb)

**Size:** 197H x 335W x 595mmD (7.8" x 13.2" x 23.4")

#### Ordering Information

**HP 3561A Dynamic Signal Analyzer**

**Opt 001 Extended Non-volatile Memory**

**Opt W30 Extended Repair Service, see pg 723.**

#### Price

\$12,400

+\$1,595

+\$215

# SIGNAL ANALYZERS

## Dual-channel, Dynamic Signal Analyzer 244 $\mu$ Hz to 102 kHz

HP 35660A

- Network and spectrum analysis
- 102.4 kHz single-channel measurements
- 51.2 kHz dual-channel measurements
- 401-line resolution
- 70 dB dynamic range
- $\pm 0.5$  dB amplitude accuracy
- $\pm 0.4$  dB and  $\pm 1.0$  degree channel match

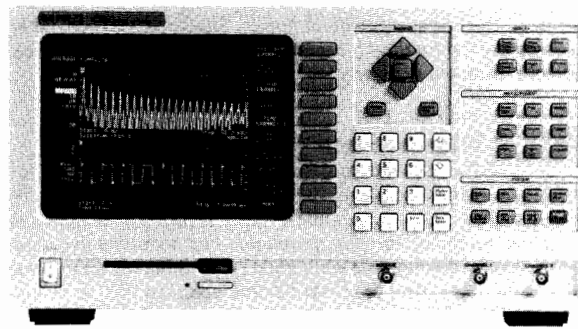

HP 35660A



### HP 35660A Dual-channel Dynamic Signal Analyzer

The HP 35660A dynamic signal analyzer is an FFT-based instrument that provides spectrum and network measurements in electronics, mechanical test, acoustics, and other low-frequency application areas. The analyzer also offers built-in test and automation features, traditionally available only with a computer. These features include an internal programming language (HP Instrument BASIC), a built-in disk drive, limit testing, and data tables. With automation built-in, the HP 35660A can save you both time and money.

#### Electrical Measurements

The HP 35660A is typically 10 to 100 times faster than swept-spectrum analyzers for equivalent measurements, and it provides higher resolution (244  $\mu$ Hz throughout the 102.4 kHz frequency range). This speed and resolution contribute to the quality of HP 35660A tests for distortion, spur level, frequency drift, intermodulation, and other signal parameters. With two input channels and a built-in source, the HP 35660A can quickly measure the response of low-frequency filters and networks.

The HP 35660A is also a good choice for low-frequency transmission measurements in telecommunications and other areas. To ensure highly accurate magnitude and phase measurements, the HP 35660A offers  $\pm 0.4$  dB gain and  $\pm 1.0$  degree input channel phase match. For custom analysis of these measurements, the HP 35660A provides a wide range of waveform math features.

#### Mechanical Measurements

The HP 35660A is well-suited to applications that require vibration monitoring at full load. With the built-in limit tables, users can implement vibration and health monitoring programs on engines, machine tools, and other equipment, without an external computer and without programming. The analyzer's internal disk drive makes it easy to record, store, and recall limits for production or maintenance testing.

The HP 35660A uses force and exponential windows to perform frequency response testing of mechanical devices and structures. Using HP Instrument BASIC, the analyzer can simplify data collection for your modal surveys. For complete modal analysis, you can choose from several third-party modal packages.

Another application area for the HP 35660A is acoustics and noise measurements. This includes testing for room and device responses, noise identification and level, and underwater acoustic tests such as sono-buoy and sonar transducer testing. Acoustic intensity measurements are available with third-party software.

#### Data tables for fast, consistent results

Data tables are a key feature of the HP 35660A. A data table eliminates the need to move markers along a trace to read multiple values.

Enter up to 400 X-axis locations in a data table; the HP 35660A fills in the table with a Y-axis value for each X entry. You can display, print, or store a completed table. For repeated measurements, you can create a unique table for each test and quickly recall each table from disk.

In addition to data tables and limit testing, the analyzer includes extensive markers to highlight harmonics and sidebands and to search for minimum, maximum, and target values.

#### HP Instrument BASIC (HP 35680A)

To simplify automation and test analysis, the HP 35660A can utilize HP Instrument BASIC, which is a subset of HP Series 200/300 BASIC running inside the analyzer. HP Instrument BASIC adds decision-making, branching, I/O, including control of other instruments, and custom user-interfaces. HP Instrument BASIC is fully syntax-compatible with HP BASIC, so current HP workstation owners can easily merge the HP 35660A and HP Instrument BASIC into their test systems.

#### HP 35660A Specification Summary

##### Frequency

**Measurement range:** 488  $\mu$ Hz to 102.4 kHz (1-channel mode)  
244  $\mu$ Hz to 51.2 kHz (2-channel mode)

**Spans:** 195.3 mHz to 102.4 kHz (1-channel mode)  
97.6 mHz to 51.2 kHz (2-channel mode)

**Resolution:** span/400 (minimum 488  $\mu$ Hz 1-channel mode;  
244  $\mu$ Hz 2-channel mode)

**Windows:** Hann, Flat Top, Uniform, Force, Exponential

**Typical real-time bandwidth:** (random noise source off)

	Single Channel	Dual Channel
Averaging off	800 Hz	400 Hz
Fast Averaging	3.28 kHz	1.6 kHz

##### Amplitude

**Range:** 3.99 mVpk to 31.7 Vpk, Manual or Auto

**Accuracy:**  $\pm 0.5$  dB + 0.03% of input range

**Dynamic range:** 70 dB

**Noise:**  $< -130$  dBV/SQRT(Hz) 160 Hz to 1.28 kHz

$< -140$  dBV/SQRT(Hz) 1.28 kHz to 102.4 kHz

**Single chan phase:**  $\pm 4.0$  degrees relative to ext trig

##### Frequency Response Channel Match

**Amplitude:**  $\pm 0.4$  dB

**Phase:**  $\pm 1$  degree (488  $\mu$ Hz to 10.24 kHz);  $\pm 1.8$  degree (10.24 kHz to 102.4 kHz)

**Input impedance:** 1 M $\Omega$   $\pm 10\%$  shunted by  $< 100$  pF

**Coupling:** ac, dc

##### Source

**Types:** Fixed sine, random, chirp

**Display results:** Frequency response, power spectrum, linear spectrum, coherence, cross spectrum, power spectral density, time

**Trace types:** log magnitude, linear magnitude, phase, real, imaginary, group delay

**Trace formats:** Single, upper/lower, front/back, setup, grid on/off, display blanking

##### HP-IB

Implementation of IEEE 488.1 and 488.2

SH1, AH1, T6, TE0, L4, LE0, SR1, RL1, PP0, DC1, DT1, C1, C2, C3, C12, E2

##### Compatible peripherals

**Disk drives:** HP SS/90 protocol disk drives (these include the 9122C,D,S; 9133D, H,L; and HP 9153A,C)

**Plotters:** Hewlett-Packard Graphics Language (HP-GL) digital plotters

**Printers:** HP-IB printers, alpha and raster dumps

#### Ordering Information

	Price
HP 35660A dynamic signal analyzer	\$12,900
Opt 001 Add 2 Mbyte RAM	+ \$1,515
Opt 002 Delete disk drive	- \$100
Opt 908 Rackmount Kit	+ \$75
Opt 910 Extra Operating Manual Set and HP-IB Programming Reference	+ \$75
Opt 915 Service Manual and Kit	+ \$645
Opt W30 Extended repair service - see page 723	+ \$260
HP 35680A HP Instrument BASIC	\$500
HP 35681A Analysis Pack	\$250

# SIGNAL ANALYZERS

## Dual-channel Dynamic Signal Analyzer 244 $\mu$ Hz to 102.4 kHz

HP 35665A

159

- Network, spectrum, waveform, transient analysis
- Flexible option structure - buy only what you need
- Up to 6.4 Mbytes deep transient capture (optional)
- HP Instrument BASIC (optional)
- 1.44 Mbyte internal LIF/MS-DOS® disk drive
- Fast update rate for interactive measurements
- High-speed processing: 8 traces/second, 12.8 kHz real-time fast average
- Computed order tracking for more stable measurements (optional)
- 32 kHz real-time octave measurements (optional)
- Fast swept-sine measurements (optional)

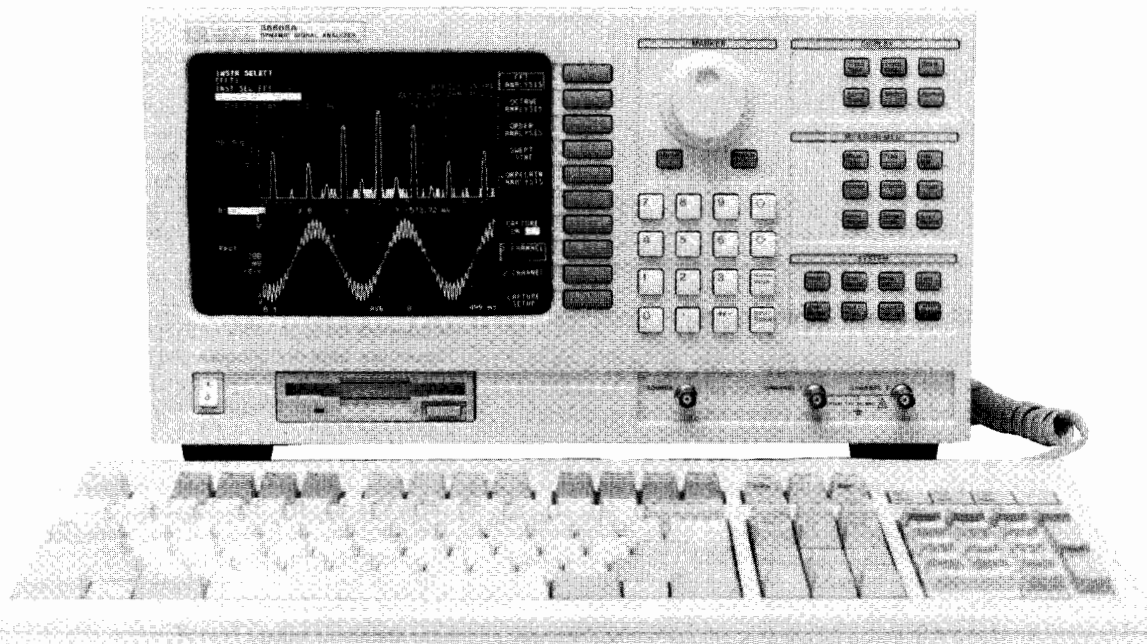

HP 35665A

### HP 35665A Dynamic Signal Analyzer

The HP 35665A is a flexible FFT-based analyzer that provides time, spectrum, network and amplitude domain measurements with a broad range of measurement options applicable in electronics, servo-mechanical and electronic control systems, machinery vibration, and general noise and vibration troubleshooting applications. The measurement options include:

- \* Computed order tracking measurements
- \* Real-time octave measurements (complies with ANSI S1.11)
- \* Swept-sine measurements
- \* Curve fit/synthesis
- \* Arbitrary waveform source

Measurement options expand the electronics test capability of the standard HP 35665A into other application areas. With the addition of HP Instrument BASIC programs, even the most complex applications can be reduced to a single keystroke. The multi-faceted measurement modes of the HP 35665A have the measurement functionality of a spectrum analyzer, network analyzer, acoustic sound-level meter, acoustic intensity analyzer, vibration analyzer, audio oscilloscope and amplitude domain analyzer in a single package.

#### Add more options as your needs evolve

Your analysis requirements can change as test needs expand and change. The HP 35665A allows you to configure your own solution to meet both your test requirements and your budget. As your needs evolve, expanding the capability of your analyzer is as easy as ordering the firmware upgrade kit that you can install yourself. Any combination of measurement options is available, with no sacrifice in measurement speed.

#### Computed order tracking eases machinery analysis

The HP 35665A computed order tracking option (Option 1D0) adds HP's order tracking capability to the HP 35665A. This algorithm digitally resamples the incoming signal resulting in extremely stable and repeatable order measurements that were not possible using analog ratio synthesis and filtering. In situations involving quickly varying and fast run up tests, this option provides unprecedented stability. It is only available on Hewlett-Packard measurement hardware.

The internal tachometer input provides a powerful and flexible triggering facility that virtually eliminates the need for external signal-shaping circuitry.

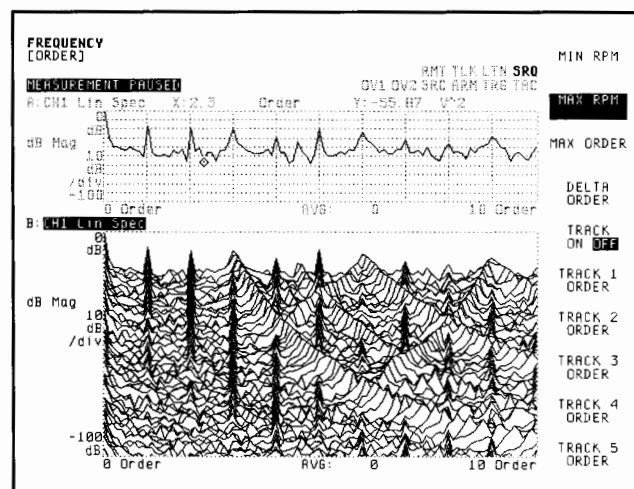

#### Real-time octave for compliance testing

Real-time octave measurements (Option 1D1) provide continuous 1/1, 1/3 and 1/12 octave measurements per the ANSI S1.11 (1986, order 3, type 1-D, extended and optional range) specification. This capability is necessary for compliance to published acoustic noise specifications such as ISO 507 Airport Noise standards. These specifications require the ability to measure impulsive signals which required separate instrumentation in the past. Now, impulsive measurements are possible as just one of many modes of this powerful instrument.

MS-DOS® is a U.S. registered trademark of Microsoft Corp.

# SIGNAL ANALYZERS

## Dual-Channel Dynamic Signal Analyzer 244 $\mu$ Hz to 102.4 kHz

HP 35665A

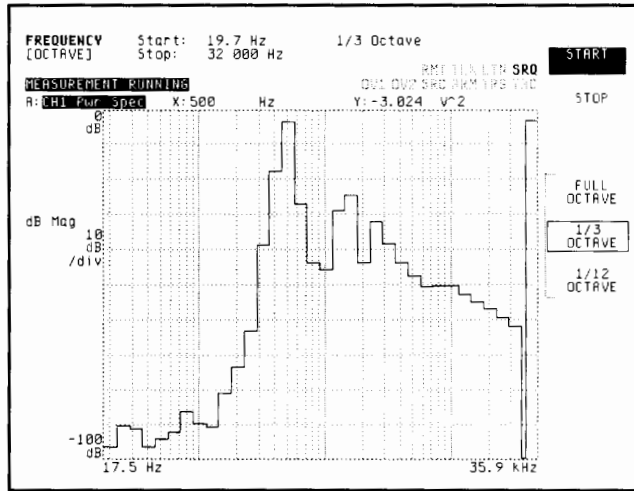

### Fast swept-sine and broadband control systems measurements

Swept-sine measurements typically offer higher signal-to-noise ratios, noise rejection and measurement accuracies than broadband techniques. The optional swept-sine measurements (Option 1D2) add this traditional measurement technique to the HP 35665A, but in an implementation that offers faster measurement results than before. Fast input auto-ranging during the measurement process increases dynamic range to a maximum of 120 dB.

Fast test time in production settings is even more critical with swept-sine tests since the instrument measurement time is usually the limiting factor in device throughput.

### Advanced modeling and analysis cut design time

The addition of curve fit and synthesis (Option 1D3) allows design engineers to measure real-life devices, compare the actual response to the design goals, model compensation circuits, and predict the end effect of the compensation circuits on the newly modified model. Curve fit and synthesis capability enhances design productivity by reducing the need to build prototypes and by simplifying the design optimization task.

### HP Instrument BASIC for powerful automation

HP Instrument BASIC (Option 1C2), a subset of HP BASIC, provides the test automation power of an external computer inside the HP 35665A. In production applications, HP Instrument BASIC, along with other production oriented features, such as limit lines, enables the HP 35665A to control external HP-IB test equipment, like voltmeters and counters, address external peripherals, like disk drives, printers and plotters, and fully automate a production test procedure with custom graphics and interactive operator prompts.

HP Instrument BASIC is also useful in R&D and field applications. Complex test sequences can be recorded and simplified to a single key press. Tests can be repeated easily by operators not familiar with the measurement problem.

Measurements like electronic filter characterization (Q, 3 dB bandwidth, shape factor), acoustic intensity, Cepstrum displays, Hilbert Transforms and multi-plane balancing can also be derived using HP Instrument BASIC.

### Specification Summary

#### Frequency

**Measurement range:** 488 mHz to 102.4 kHz (1-channel mode); 244 mHz to 51.2 kHz (2-channel mode)

**Spans:** 195.3 mHz to 102.4 kHz (1-channel mode) 97.6 mHz to 51.2 kHz (2-channel mode)

**Resolution:** Span/400 (minimum 488  $\mu$ Hz 1-channel mode 244  $\mu$ Hz 2-channel mode)

**Windows:** Hann, flat top, uniform, force, exponential

#### Amplitude

**Range:** 3.99 mVpk to 31.7 Vpk, manual or auto

**Accuracy:**  $\pm 6\%$  (0.5 dB) + 0.03% of input range

**Dynamic range:** 72 dB (FFT MODE, octave mode); 120 dB (swept-sine measurement mode)

**Noise:**  $< -130$  dBV/ $\sqrt{\text{Hz}}$  160 Hz to 1.28 kHz  
 $< -140$  dBV/ $\sqrt{\text{Hz}}$  1.28 kHz to 102.4 kHz

**Single channel phase:**  $\pm 4.0$  degrees relative to external trigger

### Frequency response channel match

Amplitude:  $\pm 0.04$  dB at full scale

Phase:  $\pm 0.5$  deg at full scale

**Input Impedance:** 1 M $\Omega$   $\pm 10\%$  shunted by  $< 100$  pF

**Coupling:** ac, dc, ICP current source engineering units A-weight filter, integration and differentiation via math functions.

### Source

**Source Types:** Fixed sine, random, chirp, burst random, pink noise, burst chirp, swept-sine (Opt 1D2), arbitrary waveform (Opt 1D4)

**Display results:** Frequency response, power spectrum, linear spectrum, coherence, cross spectrum, power spectral density, time, auto-correlation, cross-correlation, orbit (lissajous), histogram, PDF, CDF

**Trace types:** log magnitude, linear magnitude, dB magnitude, phase, real, imaginary, Nyquist, Bode, unwrapped phase.

**Trace formats:** single, upper/lower, front/back, setup, waterfall, grid on/off, display blanking

**Update-rate:** 8 traces per second

**Transient capture:** Continuous (real time) data recording to RAM

**Maximum rate:** 262,144 samples/s for 1-channel mode

**Maximum capture length:** 200 ksamples (standard), 1.2 Msamples (Opt 1B3), 3.2 Msamples (opt 1B5)

**Saved data and measurement memory:** 400 kbytes (standard), 2.4Mbytes (Opt 1B3), 6.4 Mbytes (Opt 1B5)

### Option 1D0 computed order tracking

Computed ratio synthesis, computed tracking filters

**Displays:** spectral map, order map, order track or orbit

**Trigger:** time or RPM, external or free run.

**Tachometer input:** 1 to 2048 pulses per revolution

**Trigger level:**  $\pm 20$  Volts maximum, user-selectable level

**Slope:** positive or negative

User-selectable trigger holdoff

**Option 1D1 real-time octave measurements** (All frequencies in nominal band center frequencies)

**Measurements:** 1/1 Octave (Full), 1/3 Octave, 1/12 Octave

#### Real-time frequency range:

1/1 octave measurements: 0.1 Hz to 16 kHz bands

1/3 octave measurements: 0.1 Hz to 32 kHz bands

1/12 octave measurements: 0.1 Hz to 11.3 kHz live measurements, 0.1 Hz to 45.25 kHz for post-processed time capture

**Span:** 11 octaves for all modes

### Option 1D2 Swept-sine measurements

**Sweep types:** up, down, linear, log, manual

**Input ranging:** fixed range, or auto-range during measurement

**Resolution:** selectable frequency resolution during measurement

**Source level control:** auto-level feature adjusts source level to maintain constant signal level at selected input channel.

### Option 1D3 curve fit/synthesis

20 pole, 20 zero multiple degree of freedom curve fit, auto-order selection, user-selected pole/zero location with fit: table format: polynomial, pole/zero, partial fraction expansion

### Ordering Information

HP 35665A Dynamic Signal Analyzer

Opt 1D0 computed order tracking measurements

Opt 1D1 real-time octave measurements

Opt 1D2 swept-sine measurement

Opt 1D3 curve fit/synthesis

Opt 1D4 arbitrary waveform source

Opt 1C2 HP Instrument BASIC

Opt 1B3 4 Mbyte total memory

Opt 1B5 8 Mbyte total memory

Opt 1CL external PC-style 101 key keyboard

Opt 1BH general export license version

### Price

Call HP

Call HP

Call HP

Call HP

Call HP

Call HP

Call HP

Call HP

Call HP

Call HP

Call HP



# SIGNAL ANALYZERS

## Dual-channel, Control Systems Analyzer 64 $\mu$ Hz to 100 kHz

HP 3563A

161

- Measure analog and digital signals
- Apply analog and digital stimulus
- Make swept sine and FFT frequency response measurements
- Measure spectra, waveforms, and transients
- Extract models with s- and z-domain curve fitting
- Model systems using frequency response synthesis

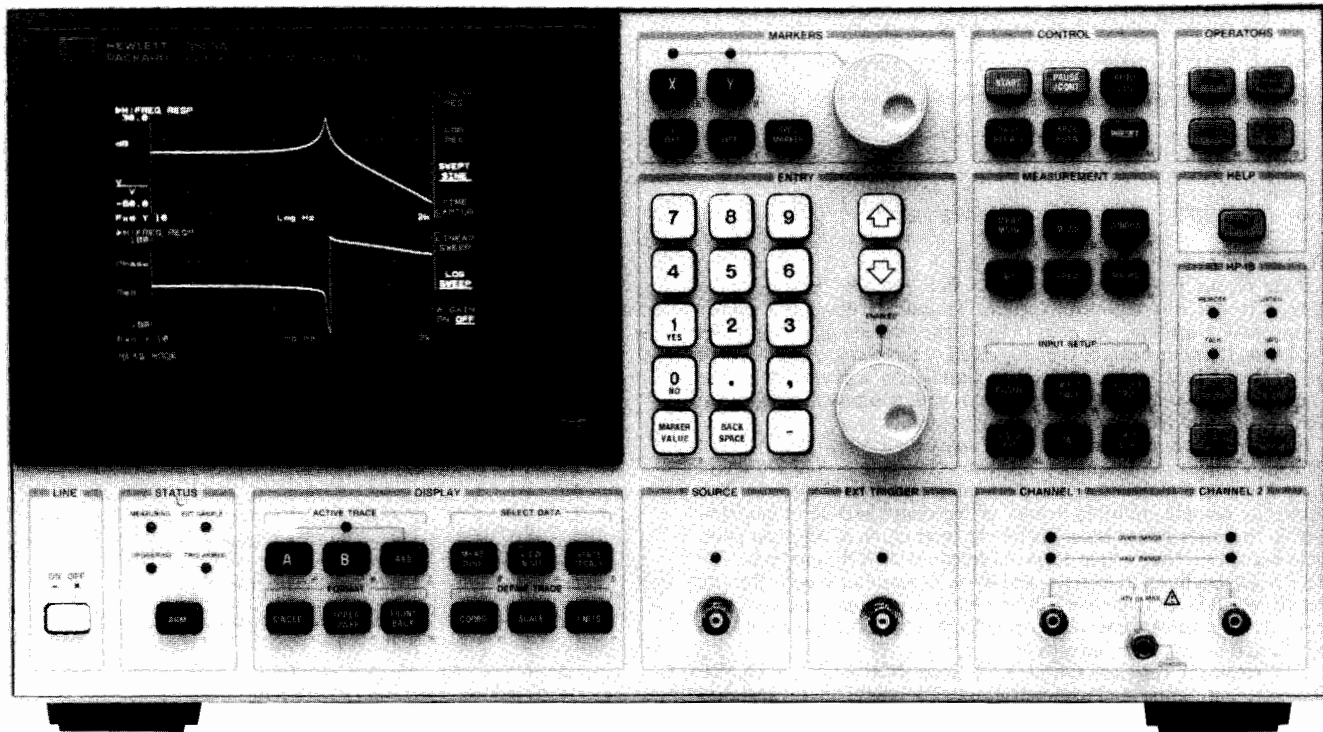

HP 3563A

### Direct Measurement of Dynamic Analog and Digital Signals

The HP 3563A control systems analyzer is the development tool that provides test and analysis of analog, digital, and mixed analog/digital systems. In the world of electronics and control systems, designs are shifting from analog to digital. Products ranging from disk drives to robots to spacecraft use closed-loop control systems containing digital filters and microprocessors rather than analog circuitry.

Hewlett-Packard helps you analyze next-generation systems with the HP 3563A control systems analyzer. A compatible superset of the popular HP 3562A dynamic signal analyzer, this FFT-based analyzer offers the versatility required to make the most difficult spectrum, network and waveform measurements in both the time and frequency domain. For analog measurements, the analyzer has two differential input channels, a 64  $\mu$ Hz-to-100 kHz frequency range, 150 dB measurement range, 80 dB dynamic range, flexible triggering, and a versatile signal source. The digital inputs accept TTL-level parallel data up to 16-bits wide with data rates as high as 256 kHz and clock rates up to 10 MHz.

### Protect Your HP 3562A Investment

If you develop, design, or test control systems, chances are you own an HP 3562A dynamic signal analyzer. If your designs now call for digital measurements, you can protect your investment in the HP 3562A by converting it to the functionality of the HP 3563A. Because the control systems analyzer is compatible with auto-sequence and computer programs written for the HP 3562A, your programming investment is also protected. For more infor-

mation regarding HP 3562A, Option 063, please contact your local HP sales representative.

### Test the Performance of Control Systems

Whether a control system is analog, digital, or mixed, you still need to characterize its stability and performance. Characterization of system stability begins with an accurate frequency response measurement. Measure frequency response magnitude and phase quickly using the linear or logarithmic resolution FFT modes. Get a detailed look at the response with the swept sine mode. Linear or logarithmic swept sine frequency response measurements can be made with up to 140 dB dynamic range. With FFT or swept sine tests, frequency response measurements are as accurate as  $\pm 0.1$  dB and  $\pm 0.5^\circ$  (see specifications for details).

Display measurement results in familiar formats such as Bode, Nyquist, and Nichols. Use waveform math to compute the open-loop response from a closed-loop measurement. Activate the special marker function to calculate and display the gain and phase margins.

Key measures of time domain performance such as rise time, overshoot, steady state deviation, and settling time are derived from the system step response. By providing a step stimulus, pre- and post-trigger delay, trace scaling, and separate x- and y-axis markers, the HP 3563A simplifies the measurement of time domain parameters.

The built-in signal source produces the stimuli commonly needed to fully characterize closed-loop control systems. In analog or 16-bit parallel format, the source will output swept sine, fixed sine, sine chirp, step, pulse, ramp, random noise, and arbitrary signals. Data editing combined with waveform math simplifies the creation of arbitrary waveforms such as sine chirps with shaped amplitude.

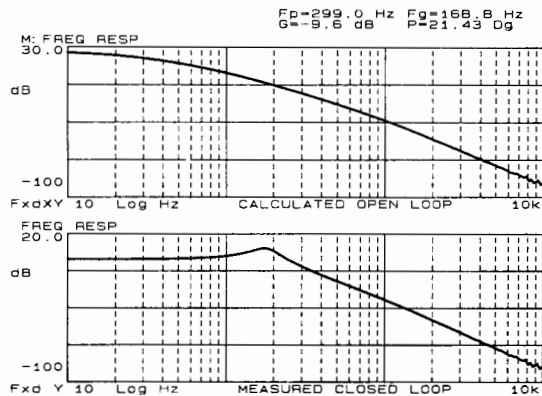

### Turning Data into Information

Plots of the frequency response or step response might not be enough to describe a control system. To quickly develop a proper compensation scheme, you need to know the location of system poles and zeros. If a compensator is being added to the system, its pole/zero model should be added to the system simulation to predict its effect. The HP 3563A addresses these problems with two powerful features: curve fitting and frequency response synthesis.

Identify system poles and zeros by applying the HP 3563A curve fitter to a measured frequency response. Separate s- and z-domain curve fitters are included to handle analog and digital systems. The frequency domain multiple degree of freedom (MDOF) algorithm used in the curve fitters accounts for the interaction of adjacent poles more accurately than single degree of freedom (SDOF) methods. The HP 3563A can fit up to 40 poles and 40 zeros simultaneously. Results are displayed in a table showing the real and imaginary parts of system poles and zeros. If needed, a pole/zero table can be converted to polynomial or pole/residue formats.

Use frequency response synthesis to model s- or z-domain control elements, actuators, and compensators. To create more accurate models, enter a time delay to simulate computational delays. Include a zero-order hold in a z-domain synthesis table to model the effect of a digital-to-analog converter in the control system. Synthesis plus waveform math lets you try a compensator design before it is built. Use waveform math to combine a synthesized response with a measured frequency response and predict the compensator's effect on system stability. If the predicted stability margins do not meet the design criteria, revise the model as many times as needed before building the compensation network.

To handle systems with a mixture of analog and digital subsystems, curve fit and synthesis tables can be transformed between the s- and z-domains. A choice of impulse invariant, step invariant, and bilinear transformations lets you use the method that matches the characteristics of your system.

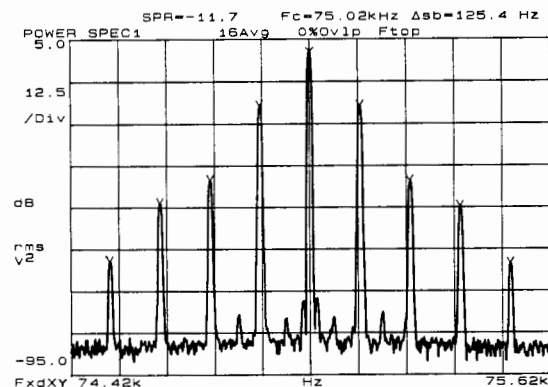

### Characterize Electronic Networks and Signals

Whether you develop digital signal processing ICs and data conversion devices or analyze the processed signals, the HP 3563A can simplify the task. Two inputs that accept analog and digital signals make

the HP 3563A a powerful spectrum and waveform analyzer. Measure frequency spectra with 801 lines of resolution,  $\pm 0.15$  dB accuracy, and 80 dB dynamic range. Special trace markers simplify analysis of distortion, sidebands, and band power. The built-in demodulation capability helps you analyze complex modulated signals in the time and frequency domains.

Perform waveform analysis by capturing signals in the internal 20K-sample capture buffer, or use time throughput to save longer events in an external HP-IB disk drive. Data scrolling and trace expansion help you locate and analyze the important parts of captured waveforms.

With a built-in signal source that generates analog and digital stimulus signals, the HP 3563A is also a versatile network analyzer. Measure the response of analog filters and devices. Test the frequency response of digital filters with a digital-in/digital-out measurement. Test the performance of digital-to-analog converters by applying digital stimulus and measuring the analog output.

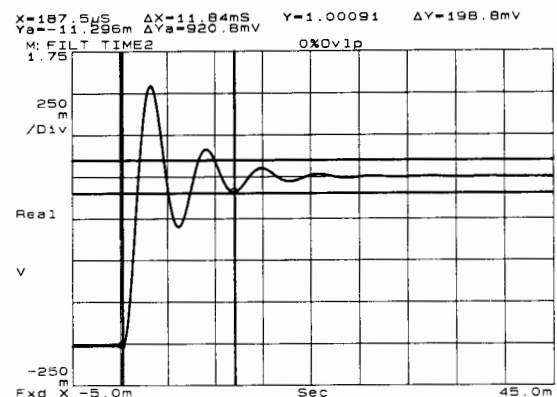

### Troubleshoot Noise and Vibration Problems

Mechanical resonance problems often appear in electromechanical control system designs. The HP 3563A provides the measurements you need to identify structural resonances, analyze motor vibration, and locate noise sources. Improve the quality of frequency response impact testing with functions such as data previewing and automatic overload rejection. Simplify interpretation of vibration measurements by selecting RPM or orders as the frequency axis and by using engineering units scaling to display amplitude in appropriate units such as displacement or velocity.

Test accessories, such as impact hammers, accelerometers, and microphones, are available through the HP test & measurement accessories catalog, and from third-party vendors. For detailed noise and vibration analysis, software solutions are available from third-party software suppliers.

### Automation Makes it Easy

Increase your productivity when automating testing or documenting results with versatile automation capabilities, such as auto sequence programming and direct control of HP-IB disk drives and plotters. Auto-sequence programming (ASP) lets you reduce a series of front-panel operations to a single keystroke. In addition to automating analyzer functions, an ASP can send commands over the HP-IB to control external devices, such as programmable switches and loads. With ASP and a sheet-fed plotter, such as the HP 7550A plotter, the HP 3563A can perform batch plotting of files saved on disk.

For computer-aided testing, the HP 3563A is also HP-IB programmable. If you use a personal computer, the PC file conversion option (Option 921) is useful. This set of utilities runs on a PC and converts HP 3563A and 3562A files to MS-DOS<sup>®</sup> format. Conversion utilities are also included to make analyzer files compatible with MATRIX<sub>X</sub> from Integrated Systems, and PC-Matlab from The Mathworks.

Note: See page 163 for specifications. A data sheet with complete specifications is available from your HP sales representative.  
MS-DOS is a U.S. registered trademark of Microsoft Corporation.

- Network, spectrum, waveform, transient analysis
- Linear, logarithmic, swept sine modes

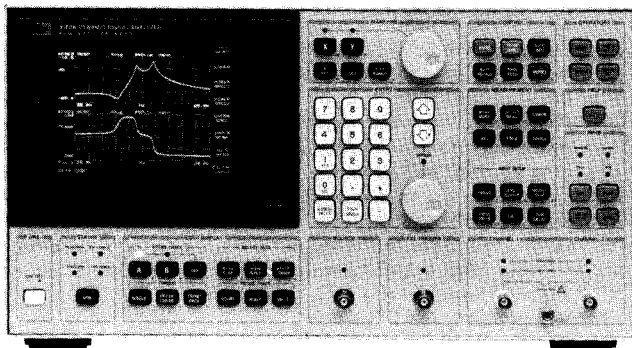

### HP 3562A Dynamic Signal Analyzer

The HP 3562A dynamic signal analyzer is well suited for design, test and analysis of electronics, mechanical systems, and electromechanical control systems. Two input channels, 64  $\mu$ Hz-to-100 kHz frequency range, 150 dB measurement range, and 80 dB dynamic range in this FFT-based analyzer, offer versatility and performance for even the most difficult spectrum, and waveform measurements, in both time and frequency domains.

The two high-performance input channels and a built-in signal source (noise and sine signals) address network analysis needs on the bench or in a test system. Vector averaging, waveform math, 40-pole/40-zero curve fitter, and frequency response synthesis enhance network measurements with a full range of analysis and modeling capabilities. Zoom analysis, with frequency resolution to 25.6  $\mu$ Hz, plus a powerful AM, FM, and PM demodulation function, make the HP 3562A a versatile spectrum analyzer. For transient or waveform analysis, signals can be sampled, digitized, then stored in internal memory, or sent via HP-IB to an external disk drive (without a computer). Stored waveforms can be recalled and analyzed in the time, frequency and amplitude domains (baseband and zoom analysis).

#### Frequency Response Measurements

You can make accurate, high-resolution frequency response measurements of electronic and mechanical systems with linear resolution FFT, logarithmic resolution and swept sine analysis. A built-in signal source provides a variety of random noise and sine wave signals to meet the requirements of the system under test.

Linear resolution is the measurement technique common to all dynamic signal analyzers. In the HP 3562A, 2048-point time records are Fourier-transformed into 801-line frequency spectra. For network analysis, frequency response magnitude and phase, as well as input and output power spectra, can be measured with 801 lines of resolution. Accuracy for the frequency response magnitude and phase is  $\pm 0.1$  dB and  $\pm 0.5^\circ$ .

The swept-sine mode configures the HP 3562A as a powerful swept-sine frequency response analyzer. The source can generate linear or logarithmic sweeps with increasing or decreasing frequency; user-selectable sweep rate and resolution are also standard source functions. Input channel functions include user-selectable averaging and integration time; automatic input ranging can be activated to provide over 140 dB of dynamic range for measurements of high performance systems.

#### Spectrum Analysis

On-line analysis of distortion, drift, modulation, and phase noise can benefit from the speed and accuracy of the HP 3562A. High-resolution measurements are typically 100 times faster than tuned spectrum analyzers. Because the HP 3562A is an FFT-based analyzer, you can see transient events a tuned analyzer would probably miss.

The HP 3562A is essentially a dual-channel spectrum analyzer that provides resolution to 25.6  $\mu$ Hz anywhere within the 64  $\mu$ Hz-to-

- 80 dB dynamic range with full alias protection
- High accuracy ( $\pm 0.15$  dB)

100 kHz measurement range. Amplitude accuracy is  $\pm 0.15$  dB with 80 dB of dynamic range. Modulation analysis can be performed on either or both channels with harmonic and sideband markers as well as with the built-in demodulation capability: zoom measurement can be AM, FM, or PM demodulated with carrier frequencies up to 99.9 kHz.

#### Waveform and Transient Analysis

Perform complete analysis of waveforms and transients in the time and frequency domains. Store sampled and digitized waveforms in internal memory (single-channel time capture) or on disk in an external disk drive (single- or dual-channel time throughput). Recall data for time domain analysis as single time records or as a compressed display of up to 10 time records (time capture mode). Data can also be recalled for baseband and zoom analysis in the frequency domain with vector averaging, if needed.

The array of triggering capabilities enhances both waveform recording modes. Pre- and post-trigger delays can be specified to capture the rising edge of a transient or to compensate for delays in the system under test.

#### Hardcopy and Mass Storage

When access to prototypes is limited, make your test time more efficient with the time throughput capability; through direct control of external disk drives, the HP 3562A stores time data directly to disk without a computer.

HP-IB is a standard feature to speed and simplify documentation of results with direct control of plotters and disk drives. Anything displayed on the analyzer screen can be plotted or saved on disk including measurement results, setup state table, synthesis tables, curve fit tables, and auto sequence or auto math program listing.

#### Automation for Improved Productivity

As a stand-alone solution, the analyzer can "learn" a series of keystrokes and then perform them on command (auto-sequence programming). Up to five auto-sequence programs can be stored internally, with additional programs stored on an external disk drive. For networked HP-IB systems, the HP 3562A provides complete HP-IB programmability. Custom display graphics messages can be created with direct programming of the display, and user-defined softkey menus can be created to simplify interactive testing.

#### Specifications (HP 3562A, 3563A)

Contact your local HP sales office for more information, including a data sheet with complete specifications.

##### Frequency

**Measurement range:** 64  $\mu$ Hz to 100 kHz. Both channels, single- or dual-channel operation.

**Resolution:** span/800. Both channels, single- or dual-channel operation, linear resolution mode.

Spans	Baseband	Zoom
# of spans	66	64
min span	10.24 mHz	20.48 mHz
max span	100 kHz	100 kHz
time record (sec)	800/span	800/span

**Window functions:** flat top, Hann, uniform, force, exponential, user-defined

##### Typical real-time bandwidths:

Single-channel, fast averaging 10 kHz

Throughput to CS/80 disk

Single-channel 12.5 kHz

Dual-channel 6.25 kHz

##### Amplitude

**Accuracy:** defined as full-scale accuracy at any of the calculated frequency points. Overall accuracy for the linear or logarithmic resolution modes is the sum of the absolute accuracy, window flatness and noise level. Overall accuracy for swept-sine mode is the sum of absolute accuracy and noise level.

# SIGNAL ANALYZERS

## Dual-channel, Control Systems Analyzers 64 $\mu$ Hz to 100 kHz (Cont'd)

HP 3563A, 3562A

**Absolute accuracy:** single channel (channel 1 or 2)  
 $\pm 0.15$  dB  $\pm 0.015\%$  of input range (+27 dBV to -40 dBV)  
 $\pm 0.25$  dB  $\pm 0.025\%$  of input range (-41 dBV to -51 dBV)

**Window flatness:**

Flat top +0, -0.01 dB

Hann +0, -1.5 dB

**Noise floor:** with flat top window, 50 $\Omega$  source impedance and input set to -51 dBV range

20 Hz to 1 kHz (1 kHz span) < -126 dBV (-134 dBV $\sqrt{\Omega\text{Hz}}$ )

1 kHz to 100 kHz (100 kHz span) < -115 dBV (-144 dBV $\sqrt{\Omega\text{Hz}}$ )

**Frequency response channel match:**

**Analog/analog:** input signals at full scale on any pair of ranges, accuracy is  $\pm 0.1$  dB,  $\pm 0.5$  degree (HP 3562A and HP 3563A).

**Digital/digital:** for simultaneous sampling on channels 1 and 2, accuracy is  $\pm 0.1$  dB,  $\pm 0.5$  degree. (HP 3563A only).

**Mixed analog/digital:** With full-scale inputs on both channels, computational delay between channels corrected for, 1:1 sampling ratio, 16 averages and 256 kHz sample clock, nominal accuracy is  $\pm 0.2$  dB,  $\pm 1.0$  degrees from 64  $\mu$ Hz to 20 kHz and  $\pm 0.2$  dB,  $\pm 4.0$  degrees from 20 kHz to 100 kHz (HP 3563A only).

**Dynamic range:** All distortion (intermodulation and harmonic), spurious, and alias products are  $\geq 80$  dB below full scale input range (16 averages).

### Analog Input (HP 3563A and 3562A)

**Input impedance:** 1M $\Omega$   $\pm 5\%$  shunted by < 100 pF

**Input coupling:** inputs can be ac or dc coupled — ac rolloff is < 3 dB at 1 Hz

**Crosstalk:** -140 dB (50 $\Omega$  source, 50 $\Omega$  input termination, input connectors shielded)

**Common mode rejection:**

0 Hz to 66 Hz 80 dB

66 Hz to 500 Hz 65 dB

**External sampling input:** TTL compatible input for signals  $\leq 256$  kHz (nominal maximum sampling rate)

### Digital Input (HP 3563A)

Measurement data signals can be up to 16 bits wide and must be parallel data in two's complement or offset-binary format. (User selects truncation of unused upper bits or rounding of the three lowest bits for data more than 13 bits wide.) The data qualifier input accepts 8 qualifier lines, a trigger, and 1 clock signal.

### Trigger

**Trigger modes:** free run, input channel 1, input channel 2, source and external trigger. Free run applies to all measurement modes. Input channel 1, input channel 2, source and external trigger apply to the linear resolution, time capture, and time throughput measurement modes.

**Trigger delay:** pre- and post-trigger delay resolution is 1 sample (1/2048 of a time record).

**Pre-trigger:** a measurement can be based on data that starts from 1 to 4096 samples (1/2048 to 2 time records) before trigger conditions are met.

**Post-trigger:** a measurement is initiated from 1 to 65,536 samples (1/2048 to 32 time records) after the trigger conditions are met.

### Analog Source (HP 3563A and 3562A)

Random noise, burst random, sine chirp, burst chirp, fixed sine, and swept sine are available from the front panel source of the HP 3562A and HP 3563A. The HP 3563A also provides step, pulse, ramp and arbitrary signals from the same front panel source output. Users can select dc offset.

**Output impedance:** 50 $\Omega$  (nominal)

**Output level:** between +10 and -10 V<sub>peak</sub> (ac + dc) into a  $\geq 10$  k $\Omega$ , < 1000 pF load. Maximum current is 20 mA.

**ac level:**  $\pm 5$  V<sub>peak</sub> ( $\geq 10$  k $\Omega$ , < 1000 pF load)

**dc offset:**  $\pm 10$  V<sub>peak</sub> in 100 mV steps. Residual offset at 0V offset  $\leq 10$  mV

**Distortion:** including subharmonics

25.6  $\mu$ Hz to 10 kHz -55 dB

10 kHz to 100 kHz -40 dB

**Pulse:** nominally 1 sample wide and bandlimited (HP 3563A)

**Digital source (HP 3563A)**

All analog signal types can be output from the digital source connector. Data format is 16-bit parallel in either two's complement or offset binary. Output level is TTL compatible.

**Maximum load:** 8 LSTTL

**Maximum output rate:** 256 kHz

### General

Specifications apply when AUTO CAL is enabled or within 5°C and 2 hours of last internal calibration

**Ambient temperature:** 0 to 55C

**Relative humidity:**  $\leq 95\%$  at 40C

**Altitude:**  $\leq 4570$  m (15,000 ft)

**Storage:**

**Temperature:** -40 to +75C

**Altitude:**  $\leq 15240$  m (50,000 ft)

**Power:** 86-127 VAC, 48 to 66 Hz

196-253 VAC, 48 to 66 Hz

450 VA maximum

**Weight:** net, 27kg (58lb); shipping, 36kg (79lb)

**Size:** 222H x 426W x 578mmD (8.75" x 16.75" x 22.75")

### Accessories Included

HP 3563A: HP 01650-61607 16-bit probe cable: 3 each

HP 03563-61605 16-bit probe pod: 3 each

HP 03563-61604 8-bit probe cable: 3 each

HP 10347A pattern generator probe lead set: 3 each

HP 5959-0288 grabber (package of 20): 80 each (4 packages)

Pouch for cables and probes

HP 3563A/HP 3562A: getting started guide, operating manual, programming reference

### Accessories Available

HP 3563A: HP 10346A 8-Channel TTL tristate buffer pod

HP 10348A 8-Channel CMOS tristate buffer pod

HP 01650-63203 termination adapter

HP 3563A/HP 3562A: transit case for one HP 3563A:

HP p/n 9211-2663

### Ordering Information

	Price
HP 3563A Control Systems Analyzer	\$24,900
Opt 907 Front Handle kit	+\$77
Opt 908 Rack Mount kit	+\$41
Opt 909 Rack Mount and Front Handle kit	+\$102
Opt 910 extra Getting Started, Operating, Programming manuals	+\$179
Option 915 add Service manual and kit	+\$100
Opt 921 PC File Utilities	+\$150
Opt 922 delete cables, pods, and pouch	-\$1,400
Opt W30 Extended Repair Service. See page 723.	+\$625
HP 3562A Dynamic Signal Analyzer	\$19,900
Opt 907 Front Handle kit	+\$77
Opt 908 Rack Mount kit	+\$41
Opt 909 Rack Mount add Front Handle kit	+\$102
Opt 910 Extra Operating manuals	+\$225
Opt 914 Delete Service manuals	-\$100
Opt W30 Extended Repair Service. See page 723.	+\$500

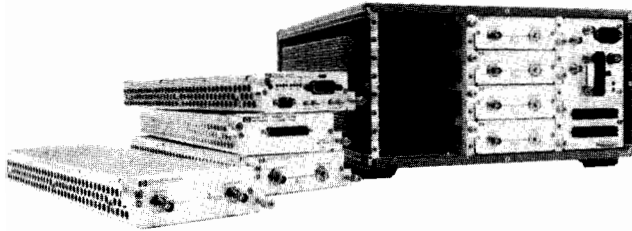

HP 3565S

### HP 3565S Multichannel Measurement System

The HP 3565S multichannel measurement system is a computer-based system for signal acquisition and analysis. The measurement hardware is modular and consists of a mainframe and plug-in modules. The mainframe can hold 8 modules, and a total of 8 mainframes can be chained together to permit a maximum of 64 modules in a single system.

There are three types of modules: a signal processing module, an input module and a source module. A system (one or more mainframes chained together) must have one, and only one, signal processing module. This module acts as the interface to the host computer as well as the controller of all the other modules in the system. The signal processing module is also used to perform digital signal processing operations on time data acquired by the input modules.

### Application Software

System performance varies depending on which application software is used to access the hardware. Software packages available for the HP 3565S include HP VISTA (for HP 9000 Series 300 workstations) and the HP 3566A and 3567A (for IBM AT compatible PCs). (See page 206 for details on HP 3565S application software.) Additional software solutions can be created with the HP Programmers Toolkit (HP 35635R) or purchased from various independent third-party software vendors. For more information on the HP 35635R or third-party solutions, contact your HP sales representative.

### HP 35650A mainframe

The HP 35650A mainframe provides power and cooling for up to 8 modules. A special cable is used to connect mainframes together to create larger systems.

### Signal Processing Modules

The signal processing module performs the following functions:

- Controls all system operations, including commands to other modules and flow of data between modules
- Transfers measurement data to the host computer via HP-IB
- Controls direct throughput to disk
- Generates time records to send to the HP 35656A source
- Processes time data from the input modules

### HP 35651B signal processing module

This signal processing module uses an MC 68020 main processor and an MC 56001 DSP processor for computing spectrums. The module includes 1 megabyte of RAM for data and program space (additional RAM is available as an option). Most application software available for the HP 3565S uses this module.

### HP 35654A signal processing module

The HP 35654 signal processing module is a higher-performance version of the HP 35651B and is used for computation-intensive applications such as high-speed waterfall displays. In general, the added capability of this module is only accessible through custom programming (as taught in the HP 35635R Programmers Toolkit course).

### Input Modules

All three input modules use analog-to-digital converters to digitize a signal. In each channel, the A/D converter is preceded by an analog anti-alias filter and followed by a digital filter (with zoom capability) and an 8K FIFO buffer. Time data from the FIFO buffers is sent to the signal processing module to be converted into spectrums.

### HP 35652A input module

The HP 35652A is a single-channel input module with dc to 51.2 kHz bandwidth and 80 dB of dynamic range. Preamplifiers for piezoelectric and ICP transducers are built-in to each module. The ICP mode provides 4 mA of constant current. The HP 35652A module also has an option for a buffered analog output. Option 001 provides a 2 volts peak (full scale) analog output.

### HP 35652B input modules

The HP 35652B input module is similar to the HP 35652A except with increased measurement bandwidth to 102.4 kHz. The HP 35652B has 80 dB of dynamic range at frequencies below 50 kHz. From 50 kHz to 100 kHz, dynamic range is 75 dB.

### HP 35655A input module

The HP 35655A input module is an 8-channel input module with dc to 12.8 kHz bandwidth for each of the 8 channels and a dynamic range of 72 dB. All eight channels have their own filtering and trigger detection. Also, all eight channels sample and hold simultaneously to maintain phase match across the channels. Each channel includes a buffered analog output.

### HP 35653A source module

The HP 35653A source module provides the following excitation signals for frequency response measurements:

- Continuous sine wave
- Band-limited random noise
- Burst random noise of variable duration

This module also includes a reference signal for system calibration of input modules.

### HP 35656A programmable DAC

The HP 35656A module uses a programmable digital-to-analog converter with 16 bits of resolution to generate arbitrary stimulus signals up to a 100 kHz bandwidth. The data buffer size is selectable from 1 to 32768 words.

### Ordering Information

	<b>Price</b>
HP 35605A system rack (for 2 mainframes)	\$1,800
HP 35606A system rack (for 4 mainframes)	\$2,300
HP 35650A mainframe	\$4,500
HP 35651B signal processing module	\$6,000
HP 35652A 51.2 kHz input module	\$2,600
HP 35652B 102.4 kHz input module	\$2,900
HP 35653A source module	\$1,950
HP 35654A signal processing module	\$14,000
HP 35655A 8-channel input module	\$9,500
HP 35656A programmable DAC	\$4,500

# SIGNAL ANALYZERS

## HP VISTA and Value-Added Business Solutions

HP 3565S, 3566A, 3567A, 3562A, 3563A, 35660A

### HP VISTA - HP 35630B

HP VISTA controls up to 256 channels of the HP 3565S multichannel measurement hardware to make broadband PSD and frequency response measurements. Time data from the input modules in the HP 3565S system is transformed into spectral data by using the signal processing module in the system. The results are available in resolutions ranging from 400 lines, for fast measurements, to 3200 lines for demanding applications, and can be either baseband or zoom in all channels. HP VISTA features include the following:

- Engineering units for calibrated vibration and acoustic measurements
- Advanced display marker features that include THD and band power computation
- Windowed user-interface that makes it easy to organize and view large sets of data
- Direct digital throughput to disk capability for high-speed data acquisition for transient events
- MIMO (multiple-input multiple-output) frequency response measurements for multi-shaker testing of large, complex structures for modal analysis

### Structural Measurement Systems (SMS)

SMS offers a comprehensive set of computer-aided testing (CAT) software for performing experimental modal analysis, structural dynamics modification, forced response simulation, and acoustic intensity analysis. SMS software operates on the HP 9000 Series 300, and HP Vectra, PS/2, and compatible personal computers.

The Modal 3.0 SE Structural Analysis System is a full-capability desktop modal analysis package. It analyzes frequency-response measurements to estimate the modal parameters of a structure and displays the resultant mode shapes in animation. Modal 3.0 SE operates on the HP 9000 Series 300 workstations in both RMB and HP-UX operating systems and supports measurements from a variety of HP instruments.

The STAR System is a series of software products for use in testing and analyzing the dynamics of mechanical structures. The STAR System runs on HP VECTRA, IBM PC-AT, PS/2 and compatible computers which support the Microsoft® Windows Operating Environment. STAR consists of three structural analysis modules and one module for acoustic analysis. Each is designed to operate alone or in conjunction with any or all of the others. Since the STAR system operates in Microsoft Windows, report generation and data transfer to other applications is very easy. STAR is an excellent match for the HP 3566A and HP 3567A.

STARModal operates on a set of measured Frequency Response Functions (FRFs) to identify the modal properties of a structure. FRF measurements are taken from HP instrumentation and processed within STARModal to estimate the modal parameters of the structure, display its mode shapes in animation and perform further analysis. STARStruct is a powerful combination of STARModal, Structural Dynamics Modification (SDM) and Forced Response Simulation (FRS).

STARAcoustics is an acoustic intensity analysis system for sound power determination and noise source identification. Crosspower measurements are taken from HP instrumentation and processed by STARAcoustics. Major features include sound power calculations, noise source ranking, surface contour plots, intensity vector display, octave analysis, microphone calibration capabilities, and A,B,C weighting curves. Links to Microsoft Windows-based applications provide superior graphics displays and quality report generation capabilities.

### Entek Scientific Corporation

Entek offers a complete modular product line for structural analysis, machinery monitoring, rotating machinery analysis, and acoustics analysis.

Six structural analysis modules run within the Entek EASY operating system. These are EMESH, EMODAL, EMDOF, ESMOD, EFORCE, AND MODENT. EMODAL is the heart of the structural analysis family and provides complete modal analysis data acquisition and SDOF curve fitting. EMESH, EMDOF, EFORCE, ESMOD provide geometry generation, multiple degree of freedom curve fitting, forced response analysis, and structural modification capabilities respectively. All of these support the full selection of HP instruments.

MODENT is a parameter estimation package. The Entek Structural Analysis Package contains all of the packages necessary for basic modal analysis: EMESH, EMODAL, EMDOF, ESMOD, and EFORCE.

EMAP is designed for rotating machinery diagnostic applications. EMAP features control the acquisition of large quantities of spectral data and the reduction of that data.

Also part of EASY, ESIM and EMESH provide acoustic analysis. ESIM is a stand-alone acoustics program which includes geometry entry, data acquisition, intensity calculation, three dimensional plotting, sound power calculation, sound source ranking, and comprehensive plotting and reporting features. EMESH is a geometry generation utility which reduces the setup time required for an acoustics test.

Predictive Maintenance (PM) is based on the routine, orderly collection of machine data to characterize the current running condition of plant equipment. Entek offers a complete, integrated line of predictive maintenance software products including MINIMONITOR, EMONITOR, AND EXAMINE. MINIMONITOR is the basic level PM software package that includes database setup, route construction, data acquisition, report generation, trend and spectrum plotting, and database management. EMONITOR offers a high level of machinery surveillance achieved through the use of full narrowband alarm generation and comparison. EXAMINE allows the user to enter a description of the monitored equipment which may include gears, bearings, shafts or impellers. MOTORMONITOR identifies motor problems associated with rotor damage or stator/rotor eccentricity conditions. An HP Instrument BASIC version of MOTORMONITOR is available for use with the HP 35660A.

### Leuven Measurement Systems (LMS)

#### LMTS in the U.S.

The LMS CADA-X System provides a comprehensive and growing set of tools to meet all the requirements of a modern test laboratory. The system is organized around four main modules, each focused on a specific application area in Computer-Aided Dynamic Analysis (CADA).

CADA Test is optimized for multi-channel data acquisition and advanced signal processing. Dedicated modules are provided for multiple input/multiple output testing (MIMO), acoustics, closed loop vibration control and rotating machinery analysis. A user-programming environment allows seamless integration of customized applications including specialized processing algorithms, embedding HP-Toolkit commands, and incorporating Fortran and C sub-programs into the system. Control and data-porting from a variety of HP Instruments are available, including the HP 3566A.

CADA Analysis includes the special-purpose analysis and 3D visualization modules necessary to analyze structural behavior under actual operating conditions. Results are processed to get a better understanding of a structure's operating deflection shapes, acoustic radiation patterns, and fatigue behavior.

CADA Modal is a comprehensive package for MIMO modal analysis. Emphasis is on global curve-fitting techniques in both the time and frequency domains. CADA Modal is completed by sensitivity analysis to show where optimal structural changes can be made and by modification simulation to show its effect.

CADA Link exposes discrepancies between modes of vibration, as derived by finite element analysis, and the actual modes measured on the prototype. Design recommendation and model updating packages then help to correct for assumptions made during the FE process by updating the FE model to match the experimental results. This provides a more reliable basis for continued analysis and provides critical feedback into the design process itself.

### Structural Dynamics Research Corporation

#### (SDRC)

SDRC's I-DEAS is a complete mechanical computer-aided engineering system for the engineering department which provides full function MCAE design, analysis, drafting, testing and NC programming. I-DEAS is comprised of a series of integrated modules based on solid geometry, with a common database and user-interface.

I-DEAS test data analysis software is the testing and general data-analysis module within I-DEAS. It provides for the management and analysis of test data. Test data can be input in a variety of ways that include data acquisition through SDRC's new data acquisition software that supports the HP 3565S hardware. Data can be in the form of time histories or functions. Test results generated within I-DEAS can be easily accessed by designers or analysts and displayed utilizing the sophisticated graphics features inherent in the I-DEAS package. Key features of I-DEAS test data analysis include general data management, general data analysis, modal analysis, and fatigue analysis.

I-DEAS Systan is an interactive, graphics-oriented program for evaluating the structural dynamic performance of mechanical systems. It is used for analytically predicting vibration and dynamic stress behavior. I-DEAS Systan supports multiple excitation functions such as force or unforced motion that can be defined in either the frequency or time domains. Resulting system responses and internal loads can then be computed and displayed. Analytical response calculations can be transferred to I-DEAS Test Data Analysis for direct measurement comparison.

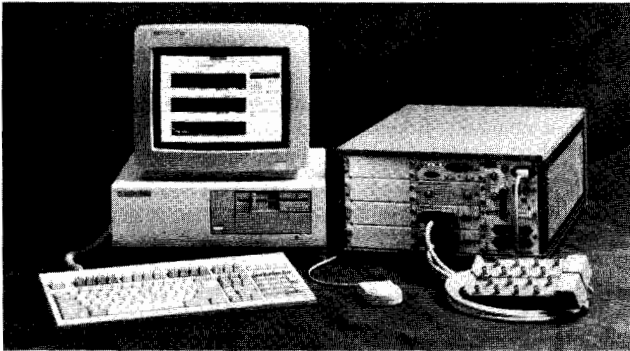

HP 3566A

### Powerful Time and Frequency Measurements Using a PC Analyzer

The 12.8 kHz HP 3566A and 102.4 kHz HP 3567A are PC-based spectrum/network analyzers that link high-performance measurement hardware (see page 165) to an HP Vectra PC (or other IBM-AT compatible) to provide flexible turnkey solutions in mechanical test, signal characterization, control systems and production test.

The HP 3566A and 3567A have the same measurement feature set, but differ in maximum frequency span and hardware configuration (see table below). Both analyzers can expand to include 16 channels that acquire data simultaneously. Each analyzer includes a source for stimulating circuits or systems. An optional programmable DAC module adds arbitrary waveform and chirp capability. For fast measurement processing, a powerful hardware signal processor module converts time data to frequency data using the latest FFT (Fast Fourier Transform) technology. The measurement hardware is linked to an HP Vectra PC (or IBM PC-AT compatible) running MS-DOS<sup>®</sup>, Microsoft<sup>®</sup> Windows, and HP's measurement software. Optional software packages give additional measurement capabilities.

	HP 3566A	HP 3567A
Channel count	8 or 16	2 to 16
Cross channel accuracy	$\pm 0.1$ dB	$\pm 1$ dB
Phase	$\pm 0.5^\circ$	$\pm 5^\circ$
Dynamic range	72 dB	80 dB
Maximum frequency span		
spectrum measurements	12.8 kHz	102.4 kHz
network measurements	12.8 kHz	51.2 kHz <sup>1</sup>
Realtime bandwidth <sup>2</sup>		
display off	12.8 kHz	26.5 kHz
display on	3.2 kHz	3.2 kHz
Transient capture rates		
max samples/sec per channel	32,768	262,144
max samples/sec to RAM	1.5 million	1.5 million
max time samples in RAM <sup>3</sup>	7.5 million	7.5 million
Waterfall display update <sup>4</sup>	5 per sec	5 per sec
Signal conditioning	ICP - 2mA	Charge amp, ICP - 4mA

<sup>1</sup> 102.4 kHz using an external source

<sup>2</sup> One channel for 3567, 2 channels for 3566

<sup>3</sup> With opt 116

<sup>4</sup> Rate applies to eight traces, updated simultaneously

### HP 3566A and 3567A Measurement Capability

- Transient capture to RAM
- Time record
- RPM spectral map
- 1/3 and 1/1 octave
- Auto-correlation
- Cross-correlation
- Frequency response gain phase
- Power spectrum
- Cross spectrum
- Nyquist
- Histogram, PDF, CDF
- Order tracking
- Order ratio map
- Orbit diagram
- Coherence
- Swept-sine
- Record/playback

### Expandable Analyzers for Mechanical Testing

The HP 3566A and 3567A offer features for all types of mechanical testing, including rotating machinery analysis, vibration test, structural analysis, and acoustic noise testing. With an expandable channel count, these analyzers are a solution for applications requiring from 2 to 16 channels. Display up to eight traces of time or frequency data to quickly view accelerometer conditions or input channel ranges. Spectral maps and order ratio maps provide a picture of machinery behavior during run-up or coast down operation. From these maps, you can easily identify the important orders of vibration.

Analyzer applications also include sound pressure testing, spatial characterization of radiated noise and noise source identification. Both the HP 3566A and 3567A provide 1/3 and 1/1 octave displays. Built-in source signals, such as impulse, random, and burst random, are available for stimulating systems.

### Multichannel Characterization of Changing Signals

Use the HP 3566A or HP 3567A to accurately measure fast-changing signals. Applications like monitoring, underwater acoustic testing, or surveillance require multichannel analyzers to process data in real time. Real-time measurement features ensure that transient events are captured and processed quickly. Eight high-speed displays allow you to monitor changes in the time or frequency domain, with waterfalls and spectrograms showing how signals change with time.

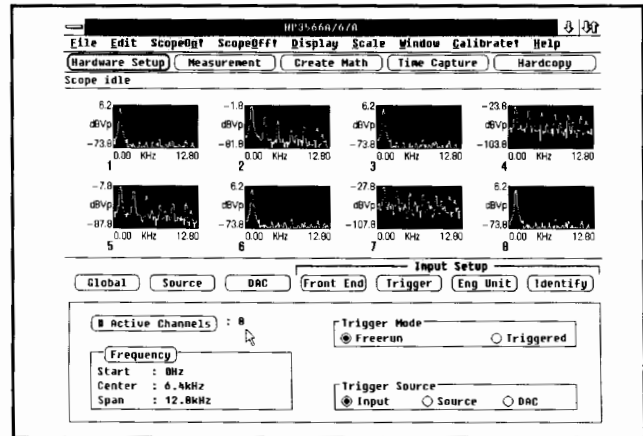

### New Order-tracking Algorithm (optional)

Quickly distinguish between order-related and nonorder-related rotating machinery signals. This optional software adds order ratio map and order track measurements to the HP 3566A and 3567A capabilities. With it you can measure an accurate order spectrum independent of changing RPM. Using new HP technology, order ratio maps and order tracks are computed digitally, eliminating the errors and added expense of ratio synthesizers, tracking filters, and RPM counters required by other FFT analyzers.

### Full-Featured Swept-Sine (optional)

Swept-sine techniques provide transfer functions with 132 dB dynamic range by changing source levels and input ranges for each frequency point measured. R&D users can dramatically reduce measurement setup times by using auto-range, auto-level and auto-resolution. Auto-resolution decreases measurement execution times by optimizing the frequency spacing between measurement points. Gain and phase margins are calculated just by pushing a button, simplifying control system analysis.

Production test users can further increase measurement speed by specifying all measurement parameters by frequency band. Up to ten separate bands allow performance optimization.

### Programmable DAC Provides Arbitrary Waveforms (optional)

A programmable 16 bit DAC allows custom waveforms to be created and used as stimulus. A DAC editor and waveform calculator simplify their creation using built-in waveform types (sine, square, triangle, exponential, random and impulse). Mathematical operations like integration, differentiation and filtering can be performed on the waveforms before they are output. In production test, chirp waveforms can be used to measure transfer functions extremely fast.

# SIGNAL ANALYZERS

## Multichannel, Spectrum/Network Analyzers 64 $\mu$ Hz to 102.4 kHz (Cont'd)

### High-Speed, Multi-channel Transient Capture

A special transient capture mode allows you to capture transients to RAM at composite sample rates up to 1.5 million samples per second. All channels are simultaneously sampled. With option 116, 7.5 million samples can be collected (option 104 gives 1.5 million samples). Captured signals can be viewed, and portions can be selected for analysis using HP 3566A/3567A measurements (except order track, order ratio map, and swept sine). Captured transients can be played back through the DAC module to recreate real-world signals.

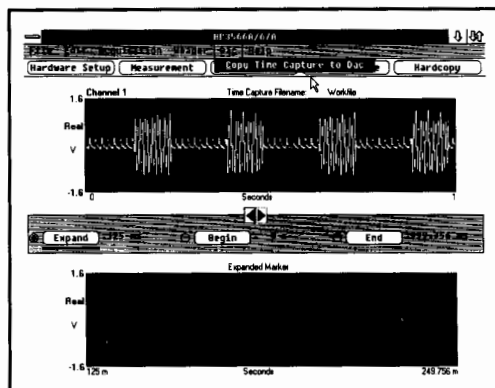

### Documentation of Results

A special Hardcopy Mode lets you document measurement results with up to six displays per page. Each display can have numerous individual annotations and pages can be labelled. Important measurement parameters and a time stamp can be automatically added to each display. Built-in pushbutton computations, like total harmonic distortion and band power, can be printed on each display. To compare many measured results easily, overlay displays can print many results on a single graticule.

Prints and plots can be made to any Microsoft® Windows supported graphics printer or HP-GL plotter (Centronics or RS-232 interface only). In addition, you can write reports using word processors and include HP 3566A and 3567A displays either by using MS Windows "cut and paste" or by importing HP-GL plot files.

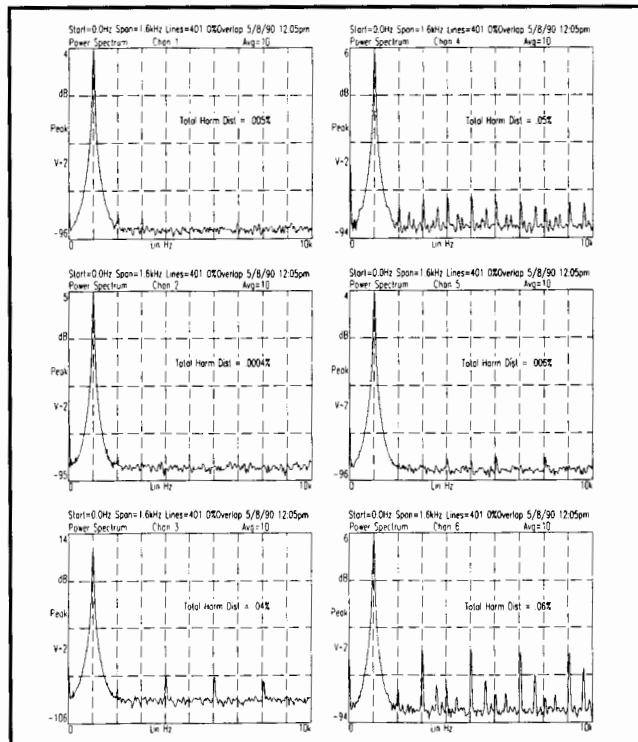

### Create Custom Measurements Easily

A full-function waveform calculator lets you create your own custom measurements and integrate them into the standard user interface. Mathematical functions can be performed on any measurement result, and the result of the operations can be displayed using the full display functionality. Results of math operations can also be output through the programmable DAC.

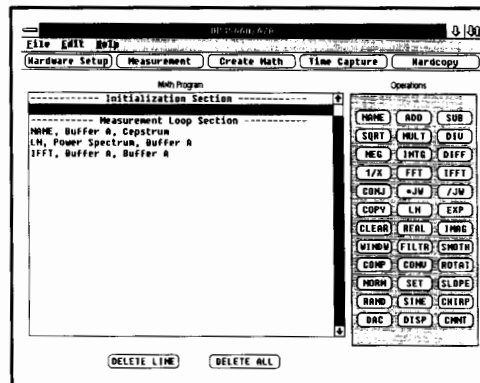

### Ordering Information

- |  |                          |
|--|--------------------------|
| <b>HP 3566A</b> spectrum/network analyzer includes 1 HP 35650A mainframe, 1 HP 35655A eight-channel 12.8 kHz input module, 1 HP 35653A source module, 1 HP 35651B signal processor module with 1 Mbyte RAM, 1 HP-IB cable, 90-day onsite hardware warranty, HP time/frequency domain measurement software with 15 months BasicLine and 3 months ResponseLine software support.   | <b>Price</b><br>\$22,000 |
| <b>Opt 010</b> add 1 HP 36655A eight-channel 12.8 kHz input module (2 eight-channel modules is maximum configuration)  | +\$9,500                 |
| <b>Opt 104</b> convert HP 35651B RAM to 4 Mbyte  | +\$2,000                 |
| <b>Opt 116</b> convert HP 35651B RAM to 16 Mbyte   | +\$7,000                 |
| <b>Opt 056</b> add HP 35656A programmable DAC module (required for chirp stimulus, arbitrary waveform and record/playback)   | +\$4,500                 |
| <b>Opt A16</b> HP Vectra QS16 with software installed  | +\$5,950                 |
| <b>HP 3567A</b> spectrum/network analyzer includes 1 HP 35650A mainframe, 1 HP 35652B single channel 102.4 kHz input module, 1 HP 35653A source module, 1 HP 35651B signal processor module with 1 Mbyte RAM, 1 HP-IB cable, 90-day onsite hardware warranty, HP time/frequency domain measurement software with 15 months BasicLine and 3 months ResponseLine software support. | \$18,000                 |
| <b>Opt 005</b> add 1 mainframe (3 mainframes is maximum configuration)   | +\$4,500                 |
| <b>Opt 010</b> add 1 102.4 kHz input module (16 input modules is maximum configuration)  | +\$2,900                 |
| <b>Opt 104</b> convert HP 35651B RAM to 4 Mbyte  | +\$2,000                 |
| <b>Opt 116</b> convert HP 35651B RAM to 16 Mbyte   | +\$7,000                 |
| <b>Opt 056</b> add HP 35656A programmable DAC module (required for chirp stimulus, arbitrary waveform and record/playback)   | +\$4,500                 |
| <b>Opt A16</b> HP Vectra QS16 PC with software installed   | +\$5,950                 |
| <b>HP 35636A</b> order tracking (optional software) for HP 3566A and HP 3567A (requires opt 104 or 116)  | \$2,500                  |
| <b>HP 35637A</b> swept-sine (optional software) for HP 3566A and HP 3567A (requires opt 104 or 116)  | \$500                    |
| <b>HP 35634A Software ONLY</b> for HP 3566A and HP 3567A (if you already have hardware)  | \$4,000                  |
| MS-DOS® is a U.S. registered trademark of Microsoft Corp.<br>Microsoft® is a U.S. registered trademark of Microsoft Corp.  |                          |



# SIGNAL ANALYZERS

## Spectrum Analyzer 20 Hz to 40 MHz

### HP 3585B

169

- New sweep gating option
- 80-100 dB dynamic range
- $\pm 0.25$  dB typical level accuracy

- 50, 75, 1 M  $\Omega$  inputs
- 3 Hz resolution bandwidth
- Automatic limit testing

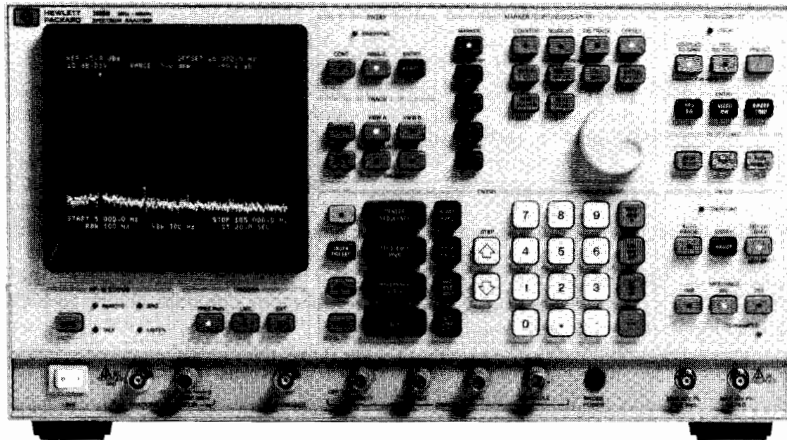

### Uncompromising Baseband Signal Analysis

The HP 3585B spectrum analyzer delivers high performance where it counts – at baseband frequencies. With very high accuracy, resolution, and dynamic range, the HP 3585B is the best solution for signal analysis at the critical frequencies comprising voice, picture, or digital information.

In today's high-speed, high-density information processing systems, maintaining the integrity of data signals requires more measurement performance than ever before. The HP 3585B provides 80-100 dB of spurious-free dynamic range, a sharp 3 Hz resolution bandwidth, and a 20 Hz–40.1 MHz frequency range to easily cover most information bandwidths. Fully synthesized tuning (including sweeps) and typical amplitude accuracy to  $\pm 0.25$  dB ensure complete measurement confidence.

### Carefully Chosen Features for Better Measurements

Measurements are faster and easier with the optimized feature set. The automatic limit test function checks all 1000 measurement points against user-defined upper and lower limits in a fraction of a second. Pass/fail results are shown in the display and are available over HP-IB for improved productivity in automated applications.

The automatic peak search and signal track functions speed signal identification and analysis and make examination of drifting signals more convenient. In addition to locating the strongest signal in a display, the peak search function can also find successively smaller signals, or search to the right or left for peaks above a user-defined threshold.

### Fast, Flexible Frequency Sweeps

Well-designed bandwidth filters and a phase-continuous, synthesized local oscillator team up with exceptional dynamic range to give the HP 3585B very fast measurement speeds. A 40 MHz sweep using the 30 kHz resolution bandwidth takes only 200 milliseconds, fast enough for high-resolution spectrum surveillance. A 1 MHz sweep using a 1 kHz bandwidth takes only 2 seconds, yet yields an average noise floor of -85 dBc.

### Powerful Marker Functions

The tunable marker readout of frequency and amplitude can be expressed as an absolute or relative (offset) value. With a single keystroke, the marker value can be entered as the center frequency, reference level, frequency span, or center frequency step size. This improves accuracy and efficiency in manual testing and reduces setup errors.

The built-in frequency counter provides additional accuracy when measuring the frequency of a signal in the display. Results are provided in 0.3 seconds to 0.1 Hz resolution. Because the counter function is combined with the selectivity of the analyzer, it is possible to accurately measure small signals in the vicinity of much larger ones.

For noise measurements, the noise level marker function displays averaged rms noise density at the marker position, normalized to a standard 1 Hz bandwidth and corrected for the analyzer's characteristics. This function can be combined with the relative measurement mode for fast, easy signal-to-noise ratio measurements.

### Measurement Hard Copy

Copying a complete display to a printer or plotter is as easy as pressing a button. The HP 3585B directly controls HP-GL compatible HP-IB plotters and graphics printers such as the HP ThinkJet.

### Tracking Generator

The standard 50  $\Omega$  tracking generator covers the full 40 MHz frequency range of the HP 3585B to provide easy scalar (amplitude-only) network analysis. The signal is fully synthesized in CW measurements and sweeps and level is adjustable from 0 dBm to -11 dBm on the front panel.

### Flexible Inputs with Autoranging

50, 75, and 1 M  $\Omega$  input impedances are all standard and are electronically selectable to match your system. For sensitive circuits, the 50  $\Omega$  and 1 M  $\Omega$  inputs and provided probe power, offer maximum compatibility with a variety of passive and active probes. With input autoranging, the HP 3585B automatically chooses the optimum input range for maximum dynamic range and lowest distortion. This eliminates the need to manually adjust attenuation and IF gain.

### Burst Signal Analysis

Spectrum analysis results from traditional swept measurements on burst signals include not only the signal of interest, but also the signal from the burst repetition period. The noise floor is higher in burst measurements, which masks the signal of interest. Accurate signal-to-noise and carrier-to-noise measurements are impossible. The new sweep gating option 001 reveals the signals you have missed.

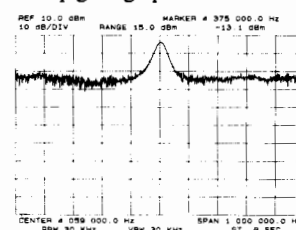

Before sweep gating

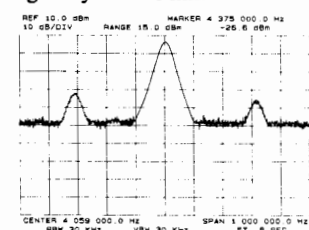

After sweep gating.

## Specifications

Specifications describe the warranted performance of the HP 3585B over the temperature range 0°C to 55°C, except where noted. Supplemental characteristics describe typical but non-warranted performance; they are described as "typical" or "approximate" and apply over the temperature range  $25 \pm 5^\circ\text{C}$ .

### Frequency

**Measurement range:** specifications apply 20 Hz-40.1 MHz  
Start/stop, center, manual frequency range: 0 Hz-40.1 MHz

**Accuracy:** (same as frequency ref. accuracy)

**Frequency span:** 0 Hz-40.1 MHz

**Frequency reference accuracy:**  $\pm 1 \times 10^{-7}$ /mo. of frequency

### Marker frequency:

**Readout accuracy:**  $\pm 0.2\%$  of frequency span  $\pm$  resolution bandwidth.

**Resolution:** 0.1 Hz

### Resolution bandwidth:

**Bandwidth:** 3 Hz-30 kHz (3 dB bandwidth) in 1, 3, 10 sequence.

**Selectivity:** 60 dB / 3 dB < 11:1

**Video bandwidth:** 1 Hz-30 kHz in 1, 3, 10 sequence

### Amplitude

**Display scale:** 10 vertical division graticule with reference level (0dB) at top graticule line

**Calibration:** 1, 2, 5, 10 dB/division

### Measurement range:

**50/75  $\Omega$  input:** -137 dBm to +30 dBm or equivalent level in dBV or volts

**1 M $\Omega$  input:** 31 n Vrms to 7.08 Vrms

**Input range settings:** autoranging, -25 dBm to +30 dBm in 5dB steps

### Amplitude accuracy

Accuracy note: measurement accuracy is determined by the sum of reference level accuracy, amplitude linearity (if the signal is not at the reference level) and frequency response across the measurement span (if the signal is not at the center or manual frequency). In measurements where the signal is at the reference level and/or at the center or manual frequency, the amplitude linearity and/or frequency response uncertainties will not apply.

### Reference level

**Range:** -100 dB to +10 dB (relative to input range)

**Accuracy:** 50/75  $\Omega$  input (using 1 or 2 dB/div., measured at manual frequency or with sweep rate reduced by a factor of 4):

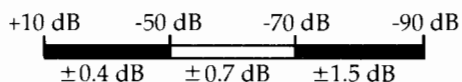

**Typical accuracy, +10 dB to -50 dB:**  $\pm 0.25$  dB. For 5 or 10 dB/div. add 0.1 dB to the figures above

**For 1 M $\Omega$  input:** Add to above specification  $\pm 0.7$  dB for 20 Hz-10 MHz;  $\pm 1.5$  dB for 10 MHz-40.1 MHz

### Amplitude linearity

50/75  $\Omega$  input (relative to reference level):

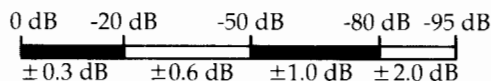

**Typical linearity 0 dB to -20 dB:**  $\pm 0.2$  dB

### Frequency response

50/75  $\Omega$  input (relative to center frequency):  $\pm 0.5$  dB ( $\pm 0.3$  dB typ.)

**For 1 M $\Omega$  input:** add to above specification  $\pm 0.7$  dB for 20 Hz-10 MHz,  $\pm 1.5$  dB for 10 MHz-40.1 MHz

### Marker amplitude accuracy:

Center or manual frequency at the reference level: Use reference level accuracy from 30 dBm to -115 dBm; add amplitude linearity below -115 dBm.

Anywhere on screen: Add amplitude linearity and frequency response (same as display accuracy)

## Dynamic range

**Spurious responses:** (image, out-of-band, and harmonic distortion)

**50/75  $\Omega$  input:**  $< -80$  dB relative to a single signal at or below the input range setting.

**Typical performance:** -84 dB - (1 dB/dB below input range setting)

**Example:** For a -8 dBm signal on the 0 dBm input range, the spurious responses would be -92 dB.

**1 M $\Omega$  input:**  $< -80$  dB, except 2nd harmonic distortion  $< -70$  dB

### Intermodulation distortion

**50/75  $\Omega$  input:**  $\leq -80$  dB relative to the larger of two signals, each  $\geq 6$  dB below input range setting except 2nd order IM from 10 MHz to 40 MHz  $< -70$  dB

**1 M $\Omega$  input:**  $< -70$  dB for 2nd order,  $< -80$  dB for 3rd order

**Residual responses (no signal at input):**  $< -120$  dBm using -25 dBm range, or 95 dB below input range setting

**Residual phase noise (typical at 40 MHz, -10 dBm input):** 5 kHz offset: -112 dBc/Hz

100 kHz offset: -120 dBc/Hz

**Maximum dynamic range (typical):** 92 dB spurious, harmonic and 3rd order IM; 115 dB signal to noise.

### Average noise level

**50/75  $\Omega$  input:**

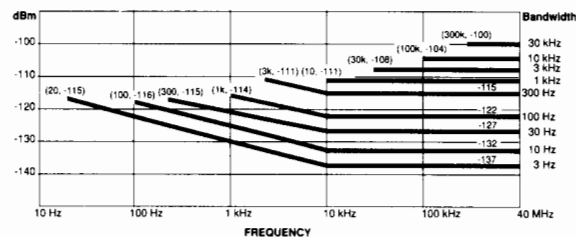

**1 M $\Omega$  input:** below 500 kHz add 12 dB to above

### Tracking generator

**Level:** 0 dBm to -11 dBm, manual control from front panel

**Frequency accuracy:**  $\pm 1$  Hz relative to analyzer tuning

**Frequency response:**  $\pm 0.7$  dB; typically:  $\pm 0.5$  dB

**Impedance:** 50  $\Omega$ , > 14 dB return loss

### Signal input

**50/75  $\Omega$ :** > 26 dB return loss, BNC connectors

**1 M $\Omega$ :**  $\pm 3\%$  shunted by < 30 pF, BNC connector

### Maximum input level

**50/75  $\Omega$ :** 13V peak ac plus dc, relay protected for overloads to 42V peak.

**1 M $\Omega$ :** 42V peak ac plus dc (derated by factor of two for each octave above 5 MHz)

**External trigger:** negative-going TTL level or contact closure initiates sweep

**External frequency reference:** 10 MHz or subharmonic to 1 MHz, 0 dBm minimum level

## General

### Environmental

**Temperature, operating:** 0° C to 55° C

**Humidity:** < 95% RH

**Warm-up time:** 20 min. at ambient room temperature

### Power

115V (11% -25%), 48-440 Hz

230V (11% -18%), 48-66 Hz

180 W, 3A max.

**Weight:** 36.7kg (81 lb)

**Size:** 229H x 426W x 635mmD cm (9" x 16.75" x 25")

## Ordering Information

HP 3585B Spectrum Analyzer

Opt W30 Extended Repair Service. See page 723.

Opt 001 Sweep Gating

Opt 002 Field Installable Sweep Gating Kit

## Price

\$25,200

+ \$605

+ \$1,500

+ \$2,000

# SIGNAL ANALYZERS

## Spectrum Analyzer 10 Hz to 150 MHz

### HP 3588A

171

- $\pm 0.2$  dB typical level accuracy
- Narrowband measurements hundreds of times faster
- 80/ 112 dB dynamic range

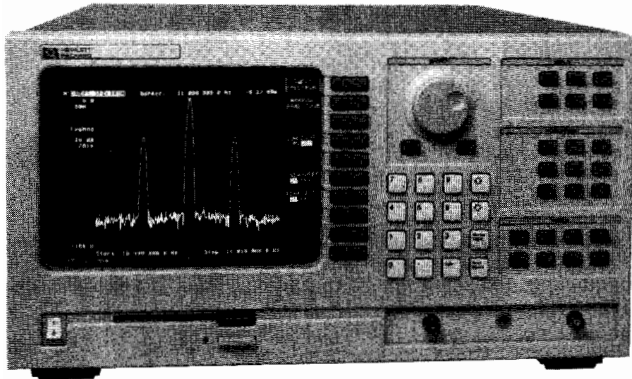

HP 3588A



### High-Performance Signal Characterization

The HP 3588A spectrum analyzer provides high-performance spectrum analysis from 10 Hz to 150 MHz, with outstanding frequency and amplitude accuracy. A wide range of frequency spans and resolution bandwidths accommodates many types of measurements. A built-in tracking generator with programmable amplitude allows easy scalar network measurements for passive and active networks.

The HP 3588A offers two measurement modes — swept spectrum and narrowband zoom. Both modes provide excellent speed and greater resolution than conventional analyzers. Swept-spectrum mode provides the performance and features of traditional swept-tuned analyzers but adds very sharp digital IF filters for improved frequency resolution ( $-3$  dB bandwidths as narrow as 1.1 Hz). Narrowband zoom uses an implementation of the Fast Fourier Transform to provide faster measurements with even greater resolving power.

Built-in autocalibration provides typical amplitude accuracy better than  $\pm 0.2$  dB. This amplitude accuracy, combined with the frequency stability and accuracy of a synthesized receiver, provides the high performance needed for the most demanding measurement situations. Maximum signal-to-noise dynamic range is 112 dB. Low-distortion mode measurements are optimized to provide 80 dB of distortion-free dynamic range.

### Unprecedented Speed and Resolution

Narrow resolution measurements with conventional swept-tuned analyzers typically require long measurement times, which can increase development time and test costs. In contrast, the HP 3588A sets new standards in speed with no loss of resolution.

Faster measurements are possible in swept-spectrum mode because the analyzer's digital IF filters have twice the selectivity of analog filters and offer faster measurements while still resolving low-level carrier sidebands. The predictability of digital filters also permits the analyzer to sweep even faster, using a built-in correction algorithm. This improves measurement speed up to four times compared to conventional swept-tuned analyzers, with no additional amplitude error or resolution loss.

Narrowband-zoom mode provides the fastest spectrum measurements (40-400 times faster than swept-tuned analyzers for comparable measurements), with resolution unequalled by traditional technologies. Narrowband zoom can be used for spans of 1 Hz to 40 kHz ANYWHERE in the 150 MHz range of the HP 3588A.

### Extensive Features Offer a Complete Solution

It is easy to design custom measurements with the HP 3588A because it supports the HP Instrument BASIC programming language, which also lets you control other instruments through HP-IB. You

- Internal HP Instrument BASIC and controller option
- Built-in 3.5-inch flexible disk drive
- Scalar network analysis; built-in tracking generator

can use the analyzer's built-in disk drive or non-volatile memory to store and retrieve traces, instrument states, or programs. Other features include autoranging input, limit lines with go/no-go indication, direct plotter or printer output, and HP-IB operation—all of which allow faster setup and documentation of results.

### Noise and Modulation Analysis Applications

With the HP 3588A, a broad range of communication equipment can be quickly characterized to meet demanding standards. Direct noise and discrete sideband measurements of signals below 150 MHz are possible with the narrow resolution and low internal phase noise. Narrowband-zoom mode provides power line frequency, voice channel, and audio band modulation sideband analysis at speeds not available in conventional swept-tuned spectrum analyzers.

### Specifications Summary

Refer to the technical data sheet for full specifications. The following specifications are valid from 0 to 55C.

#### Amplitude

Measurement range	50/75 $\Omega$	1 M $\Omega$
Maximum safe input level	50/75 $\Omega$	1 M $\Omega$
Average continuous power (10 Hz to 150 MHz)	26 dBm	—
Combined ac/dc	$\pm 4$ Vpk	$\pm 25$ Vpk
A/D overload level	> 2 dB (relative to selected range)	

#### Dynamic range

Noise level 50  $\Omega$  input (dBm/Hz using the marker noise function):  $-134$  dBm, 30 kHz to 150 MHz. For more information see the HP 3588A technical data sheet.

Note: Typical noise floor for some narrowband-zoom measurements can be as low as  $-150$  dBm. See the HP 3588A technical data sheet.

#### Spurious responses

##### General

Unless specifically mentioned in other spurious specifications, spurious responses are  $< -70$  dBc for signal levels less than range. ( $< -80$  dBc typical)

##### Harmonic distortion

**Low-distortion mode, 50 and 75  $\Omega$  inputs:** Intermodulation distortion products are  $< -80$  dBc ( $< -90$  dBc typical) with respect to 2 tones 6 dB below range. Degrade specification by 10 dB when low-distortion mode is off.

**1M  $\Omega$  input:**  $< -65$  dBc ( $< -75$  dBc typical.)

##### Residual responses

Residual responses are less than  $-110$  dBm on the  $-20$  dBm range. Degrade specification by 10 dB when low-distortion mode is on. Degrade 10 dB for 40 kHz spans in narrowband zoom mode.

##### Image, multiple and out-of-band responses:

$< -70$  dBc ( $< -80$  dBc typical) where applied carrier level is less than range.

##### Spectral purity

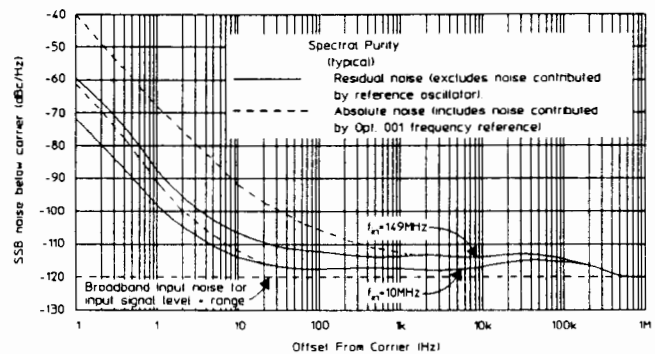

# SIGNAL ANALYZERS

## Spectrum Analyzer 10 Hz to 150 MHz (cont'd)

### Amplitude accuracy

Note: Measurement accuracy is determined by the sum of full scale accuracy and scale fidelity (linearity). For measurements made at full scale (signal level=range), only reference level accuracy must be considered. Recalibration due to change in center or manual frequency is not required for the accuracy shown below.

**Full scale absolute accuracy** (applies over the complete 0 to 55°C temperature range)

	10 Hz	100 Hz	30 kHz	300 kHz	40 MHz	150 MHz
50 Ω Input	±2.5 dB (1 dB typ)	±1.0 dB (0.5 dB typ)	±0.5 dB	±0.4 dB (0.2 dB typ.)	±0.5 dB	
75 Ω Input	±2.5 dB	±1.0 dB		±0.8 dB		
1 MΩ Input	±2.5 dB	±1.0 dB	±0.6 dB			

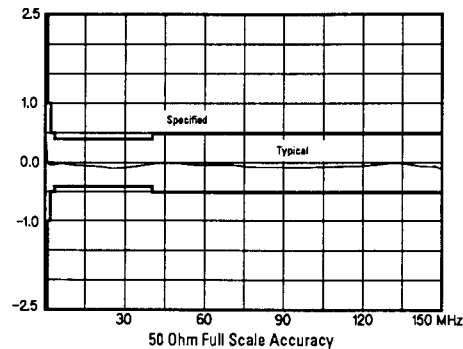

The calibration procedures produce the greatest accuracy at 300 kHz. Full scale absolute accuracy at 300 kHz is ±0.3 dB (0.1 dB typical) when input level = range. Accuracy is specified for manual frequency or for sweeps where sweep time is increased by 4. Add ±0.1 dB for autocoupled sweep times. Narrowband zoom note: Measurement data is 'windowed' in the FFT operation of the narrowband zoom mode to optimize amplitude accuracy or frequency resolution. This adds the following frequency response errors to the full scale absolute accuracy specifications above.

High-accuracy mode (Flat-Top window): ±0.005 dB  
High-resolution mode (Hanning window): +0, -1.5 dB

### Scale Fidelity

Level	Specified	Typical
0 to -30 dB	<0.05 dB	0.01 dB
-30 to -40 dB	<0.1 dB	0.02 dB
-40 to -50 dB	<0.3 dB	0.02 dB
-50 to -60 dB	<0.5 dB	0.10 dB
-60 to -70 dB	<0.7 dB	0.10 dB
-70 to -80 dB	—	0.25 dB
-80 to -90 dB	—	0.25 dB
-90 to -100 dB	—	0.40 dB

Example: Typical cumulative accuracy for a signal of -45 dBm at 100 MHz is calculated by summing full scale absolute accuracy and scale fidelity. i.e. (0.2 dB + 0.01 dB) = 0.21 dB

Input Port Return Loss >20 dB

### Frequency Specifications

#### Frequency Accuracy

Frequency accuracy is the sum of initial accuracy, aging and frequency counter resolution. Accuracy is measured with frequency counter function.

Initial Accuracy	Without opt. 001	With opt. 001
20 to 30°C	±0.5 ppm	±0.01 ppm
0 to 55°C	±3.0 ppm	±0.07 ppm
Aging	±0.25 ppm/mo	±0.125 ppm/mo

Frequency counter resolution: 0.1 Hz

#### Frequency span range (characteristic only)

##### Swept spans:

Range: 10 Hz to 150 MHz, and zero span  
Resolution: 0.1 Hz  
Start/stop frequency: 0 Hz to 150 MHz

##### Narrowband-zoom spans:

Range: 1.23 Hz to 40 kHz in X2 steps

### Resolution bandwidth

Swept spectrum mode filter RBW 1.1 Hz to 17 kHz ±10%  
Narrowband zoom mode:

High-accuracy mode 0.90% of span (11 mHz-360 Hz)  
High-resolution mode 0.37% of span (4.5 mHz-148 Hz)

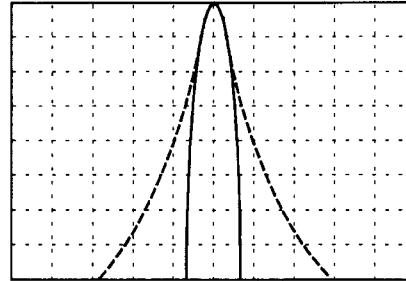

HP 3588A digital RBW filter shape (solid line) compared with a standard (Gaussian) analog RBW filter of equivalent 3 dB bandwidth. Shape factor of the analog filter is approximately 11:1

### Measurement speed (characteristic only)

Sweep rate, oversweep off:  $RBW^2 \div 2$  Hz/s  
Sweep Rate, oversweep on:  $4 \times (RBW^2 \div 2)$  Hz/s

Note: Analog Gaussian RBW filters are usually swept at  $RBW^2 \div 2$  Hz/s (or slower), to limit amplitude errors to <0.1 dB. The oversweep mode of the HP 3588A provides 4 times faster sweep times without increased error.

Narrowband-zoom mode: >7 measurements/s (for spans  $\geq 10$  kHz)

HP-IB binary trace output: approx. 120 ms/trace

Narrowband zoom (FFT):  $400 \div \text{span}$  (Hz) seconds (time record length)

Video bandwidth: Coupled to RBW from  $(1.54 \times RBW)$  to  $(0.012 \times RBW)$  in 7 steps, and OFF

### Source Specifications

Amplitude range: +10 dBm to -59.9 dBm and OFF

Amplitude resolution: 0.1 dBm

Absolute amplitude accuracy: ±1 dB (at 300 kHz and +10 dBm output level)

Dynamic accuracy: Add 0.02 dB/dB below 10 dBm output level to the absolute accuracy

Frequency response: ±1 dB (Variation relative to level at 300 kHz)

Frequency range: 10 Hz to 150 MHz

### General Specifications

#### Environmental

Operating temp, standard inst: 5 to 50°C

Operating temp, delete disk opt: 0 to 55°C

#### Power requirements

115 Vac operation: 90-132 Vrms, 47-440 Hz

230 Vac operation: 198-264 Vrms, 47-66 Hz

Maximum power dissipation: 450 VA

#### Physical

Weight: net, 28kg (61 lb); shipping, 38kg (81 lb)

Size: 222H x 425.5W x 630 mmD (8.75" x 16.75" x 24.8")

#### Memory

Standard internal memory: 1 Mbyte RAM, fully partitionable

Memory Option 003: Additional available 2 Mbyte RAM

### Ordering information:

HP 3588A spectrum analyzer	Price
HP 3588A spectrum analyzer	\$18,900
Opt 001 precision frequency reference	+\$850
Opt 003 additional 2 Mbyte RAM	+\$1,500
Opt 004 delete disk drive	-\$100
Opt 1C2 HP Instrument BASIC	+\$500
Opt 908 rack mount kit	+\$75
Opt 915 service kit	+\$900
Opt 916 extra operating manual	+\$95
Opt 920 extra HP-IB manual	+\$75
Opt W30 extended repair service. See page 723.	+\$495

# SIGNAL ANALYZERS

Spectrum Analyzers, Portable

HP 8590 Series

173

- Easy-to-use, portable spectrum analyzers
- Full range of price and performance options

- Expanded memory and trace-storage capability
- Custom measurement personalities

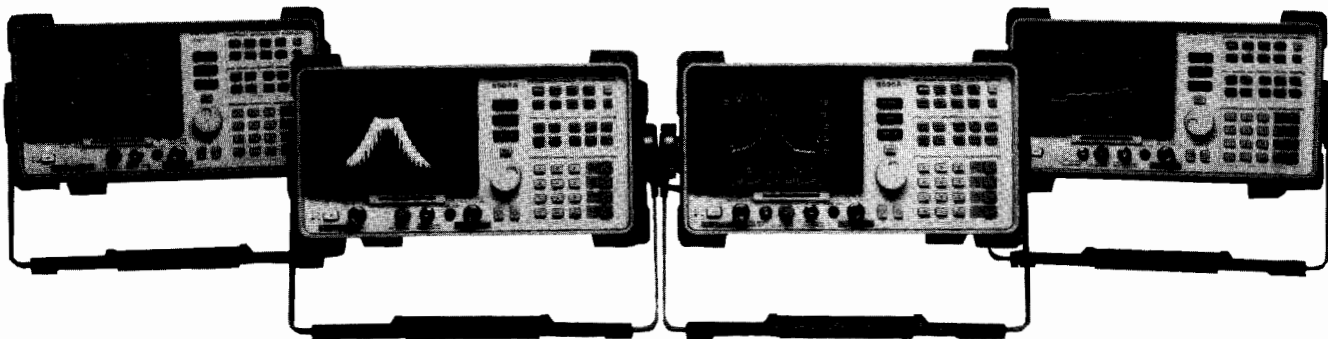

HP 8590 series

## HP 8590 Series Spectrum Analyzers

This family offers a wide range of performance, features, and prices designed to fit your budget. Choose from two low-cost, basic performance analyzers or from four higher-performance models with synthesizer accuracy. Whatever your choice, you will find HP 8590 series spectrum analyzers easy to use and reliable. Their expandable feature sets allow them to be easily configured to meet your growing measurement needs.

Many options available for these portable spectrum analyzers can be added at the time of instrument purchase or any time after. You can also add a variety of printers, plotters, and accessories to help make your job easier.

## Measurement Personalities

The HP 8591A, 8593A, 8594A, and 8595A portable spectrum analyzers include a built-in memory card reader and expanded program memory for storing measurements. The HP 8590B and 8592B include the expanded program memory and can be configured with the card reader as an option.

The memory card reader can be used to load application-specific measurement personalities into the analyzer. HP offers several measurement personality cards to customize your instrument for cable television, electromagnetic interference, and digital radio testing.

## HP 85711A CATV Measurement Personality

This card customizes your HP 8590-series spectrum analyzer for headend testing, proof-of-performance measurements, trunk maintenance, and (with a microwave analyzer) CARS-band testing. Single-key functions include channel selection by number and beats identification, carrier level, carrier-to-noise ratio, power-line hum, cross modulation, composite triple beat, video-modulation depth, and non-intrusive frequency response. With HP 8591A or 8593A option 301, you can listen to AM and FM signals and measure modulation depth on individual TV lines selected by number. HP 8590 series options H80 and H81 let you view TV pictures on the CRT of the spectrum analyzer.

## HP 85712B EMC Measurement Personality

This card adds capabilities to an HP 8590-series spectrum analyzer for custom electromagnetic compatibility (EMC) diagnostic and pre-compliance measurements. EMC applications include field-strength testing in close fields, peak response measurements weighted for broadband emissions, and identification of narrowband and impulse (broadband) signals. Accessories such as a preamplifier and set of two close-field probes complement the EMC measurement capabilities added to the analyzer by this personality. (See page 200 for more information on EMC test products.)

## HP 85713A Digital Radio Measurements Personality

This measurement card for your microwave portable analyzers includes five major agency masks for testing to US, UK, and FRG digital radio specifications. Automatic compare-to-mask and mean-power-level measurements are made on the modulated signal. Measurement functions include transient-analysis monitoring and frequency-response measurement. You can create and store your own masks and recall them for later use. Additional digital radio tests, including multipath fading margin, power measurements, and flatness, are available using the HP 11758T digital radio test system.

## Ordering Information

	Price
HP 85700A blank 32-Kbyte memory card	\$100
HP 85711A CATV measurements personality	\$600
HP 85712B EMC measurements personality	\$860
HP 85713A digital radio measurements personality	\$770

## Selected accessories

HP 85901A portable ac power source	\$1,120
HP 11758T digital radio test set	\$58,000
HP 11945A Opt E51 close-field probe set	\$3,640
HP 11946A quasi-peak adapter/AM-FM demodulator upgrade kit	\$1,910
HP 8447D broadband preamplifier (100 kHz-1.3 GHz)	\$1,540
HP 41800A active probe (5 Hz to 500 MHz)	\$1,700
HP 85024A high frequency probe (300 kHz to 3 GHz)	\$1,900
HP 2225A/B ThinkJet printer	\$495
HP 7440A ColorPro plotter	\$1,295

☎ For same-day shipment, call HP DIRECT at 800-538-8787

# SIGNAL ANALYZERS

## Spectrum Analyzers, Low-cost Portable

HP 8590B, 8592B

- Low price
- Easy to use

- Sturdy and lightweight
- Measurement personalities

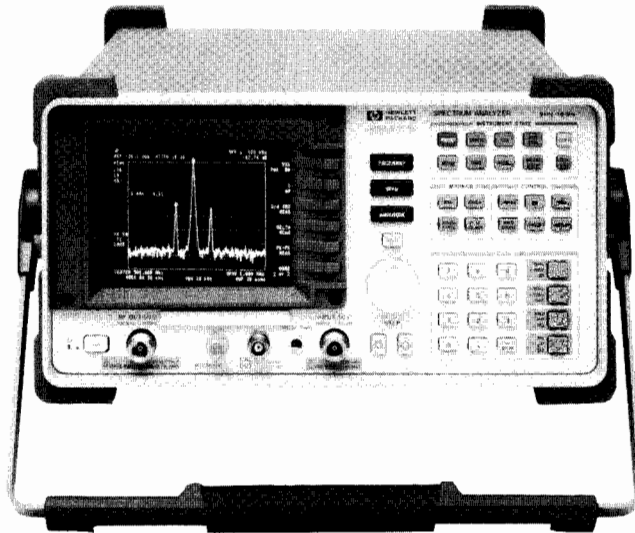

HP 8590B



HP 8592B



### HP 8590B and 8592B Spectrum Analyzers

These models offer basic RF and microwave measurement performance at a low cost. The HP 8590B has a frequency range of 9 kHz to 1.8 GHz, a 50- or optional 75-ohm input, and a weight of only 13.6 kg (30 pounds). Amplitude range is a wide  $-115$  to  $+30$  dBm. The HP 8592B has a frequency range of 9 kHz to 22 GHz (or 25 GHz with option H25), an internal preselector, and a weight of (35 pounds) 15.9 kg. Amplitude range extends from  $-114$  to  $+30$  dBm. (For special applications or general export, the HP 8592B option 1BH does not tune above 18 GHz nor span greater than 2.3 GHz.) If ac power is not available, both spectrum analyzers can be operated using the HP 85901A portable ac power source.

### One Spectrum Analyzer for Many Applications

You can change the test capabilities of these spectrum analyzers to fit specific measurement needs. An optional memory card reader enables you to load specific measurement personalities for cable television, electromagnetic compatibility, or digital radio applications. Complex measurement routines and test limits are available at a keystroke. An optional built-in tracking generator provides the HP 8590B RF analyzer with a synchronously swept signal source for stimulus-response measurements. Operating these analyzers requires only minimal training.

### Easy-to-Use Features

Numerous features make it easier to control your measurements and to analyze the results. Both portable spectrum analyzers have built-in, automatic calibration to ensure measurement consistency. Frequency panning lets you quickly reposition signals without repeated sweeps. The internal memory allows 50 traces to be stored, and 24 more can be stored on a RAM card with addition of the optional memory-card reader. Time-and-date stamping come standard. Direct output to printer or plotter are available with either the HP-IB or RS-232 interface option.

### HP 8590B Specifications

#### General

##### Temperature range

**Operating:**  $0^{\circ}$  to  $+55^{\circ}$  C

**Storage:**  $-40^{\circ}$  to  $+75^{\circ}$  C

**EMI compatibility:** CISPR Pub. 11 and FRZ 526/527/79

**Audible noise:**  $<37.5$  dBA pressure and  $<5.0$  Bels power (ISODP7779)

**Power requirements:** 86 to 127 or 195 to 250 Vrms, 47 to 66 Hz. 103 to 126 Vrms, 400 Hz  $\pm 10\%$

#### Frequency

**Range:** 9 kHz to 1.8 GHz; 1 MHz to 1.8 GHz option 001

**Readout accuracy:**  $\pm(5$  MHz + 1% of frequency span)

#### Span

**Range:** 0 Hz (zero span), 50 kHz to 1.8 GHz

**Accuracy:**  $\pm 3\%$  of indicated span

#### Sweep time

**Range:** 20 ms to 100 s

**Accuracy:**  $\pm 3\%$  of indicated sweep time

**Sweep trigger:** free run, single, line, video, external

#### Stability

**Drift:**  $<75$  kHz/5 minutes after 2-hour warmup and 5 minutes after setting center frequency

**Noise sidebands:**  $<-95$  dBc/Hz at  $>30$  kHz offset from CW signal

**System related sidebands:**  $<-65$  dBc at  $>30$  kHz offset from CW signal

## HP 8590B Specifications (continued)

### Amplitude

**Amplitude range:** -115 to +30 dBm (50 ohm); -63 to +75 dBmV (75 ohm, option 001)

**Maximum safe input level:** **50 ohm** **75 ohm (option 001)**

Average cont. power	+30 dBm (1 watt)	+75 dBmV (0.4 watts)
Peak pulse power	+30 dBm (1 watt)	+75 dBmV (0.4 watts)
DC	25 Vdc	100 Vdc

**Gain compression > 10 MHz:**  $\leq 0.5$  dB (total power at input mixer = -10 dBm)

**Displayed average noise level:**  $< -115$  dBm to  $< -113$  dBm

### Spurious responses

**Second harmonic distortion > 5 MHz:**  $< -70$  dBc for -45 dBm tone at input mixer

### Third-order intermodulation

**Distortion > 5 MHz:**  $< -70$  dBc for two -30 dBm tones at input mixer and >50 kHz separation

**Other input-related:**  $< -65$  dBc for  $\geq 30$  kHz offset from CW signal

### Residual responses (input terminated and 0 dB attenuation)

150 kHz to 1 MHz	<b>50 ohm</b>	<b>75 ohm (option 001)</b>
1 MHz to 1.8 GHz	$< -90$ dBm	N/A
	$< -90$ dBm	$< -38$ dBmV

### Display range

**Log scale:** 0 to -70 dB from reference level is calibrated;

1 to 20 dB/division in 1 dB steps; 8 divisions displayed

**Linear scale:** 8 divisions

**Scale units:** dBm, dBmV, dBmicroV, volts, watts

**Marker readout resolution:** 0.05 dB for log scale; 0.05% of reference level for linear

### Reference level

**Range:** -115 to +30 dBm (50 ohm); -63 to +75 dBmV (75 ohm)

**Resolution:** 0.01 dB for log scale; 0.12% of ref lev for linear

### Accuracy (referred to -20 dBm reference level)

**0 to -59.9 dBm:**  $\pm(0.5$  dB + input attenuator accuracy at 50 MHz)

**-60 to -115 dBm:**  $\pm(1.25$  dB + input attenuator accuracy at 50 MHz)

### Frequency response, 10 dB input attenuation

**Absolute:**  $\pm 1.5$  dB, referred to 300 MHz CAL OUT

**Relative flatness:**  $\pm 1.0$  dB, referred to midpoint between highest and lowest frequency response deviations

### Calibrator output

**Frequency:** 300 MHz  $\pm 30$  kHz

**Amplitude:** -20 dBm  $\pm 0.4$  dB (50 ohm); +28.75 dBmV  $\pm 0.4$  dB (75 ohm, option 001)

### Input attenuator

**Range:** 0 to 60 dB, 10 dB steps

**Accuracy:**  $\pm 0.5$  dB at 50 MHz, ref 10 dB attenuation, 0 to 50 dB;  $\pm 0.75$  dB at 50 MHz, ref 10 dB attenuation, 60 dB

**Resolution bandwidth:** 1 kHz to 3 MHz, -3 dB nominal

**Switching uncertainty, referred to 3 kHz RBW:**  $\pm 0.4$  dB for 3 kHz to 3 MHz RBW;  $\pm 0.5$  dB for 1 kHz

**Video bandwidth range:** 30 Hz to 1 MHz

**Log to linear switching:**  $\pm 0.25$  at reference level

### Display scale fidelity

**Log incremental accuracy:**  $\pm 0.2$  dB/2 dB, 0 to -70 dB from ref lev

**Log maximum cumulative:**  $\pm 0.75$  dB, 0 to -60 from ref level;  $\pm 1.0$  dB, 0 to -70 dB from ref level

**Linear accuracy:**  $\pm 3\%$  of reference level

## HP 8592B Specifications

### Frequency

**Range:** 9 kHz to 22 GHz; 9 kHz to 25 GHz (option H25)

**Readout accuracy:**  $\pm[(5 \text{ xN}) \text{ MHz} + 0.01\%$  of center frequency + 2% of frequency span]

### Span

**Range:** 0 Hz (zero span), (50 x N) kHz to 19.25 GHz

**Accuracy:**  $\pm 2\%$  of span, span  $> 10$  MHz;  $\pm 5\%$  of span, span  $< 10$  MHz

### Sweep time

**Range:** 20 ms to 100 s

**Accuracy:**  $\pm 3\%$  of indicated sweep time

**Sweep trigger:** free run, single, line, video, external

### Stability

**Noise sidebands:**  $<(-95 + 20 \log N)$  dBc/Hz  $> 30$  kHz offset from CW

**System-related sidebands:**  $< -65$  dBc + 20 log N at  $> 30$  kHz offset from CW signal

**Comb generator frequency accuracy:** 100 MHz fundamental freq  $\pm 0.007\%$

### Amplitude

**Range:** -114 to +30 dBm

**Maximum safe input:** +30 dBm (1 watt, 7.1 Vrms), 0 Vdc

**Gain compression:**  $\leq 0.5$  dB (total power at input mixer = -10 dBm)

**Displayed average noise level:**  $\leq -114$  to  $\leq -92$  dBm

### Spurious responses

#### Second harmonic distortion

**10 MHz to 2.9 GHz:**  $< -70$  dBc for -40 dBm tone at input mixer

**> 2.75 GHz:**  $< -100$  dBc for -10 dBm tone at input mixer (or below displayed average noise level)

#### Third-order intermodulation

**Distortion > 10 MHz:**  $< -65$  dBc for two -30 dBm at input mixer and  $> 50$  kHz separation

**Other input related:**  $< -70$  dBc for applied freq  $\leq 18$  GHz;  $< -60$  dBc for applied freq  $\leq 22$  GHz

### Display range

**Log scale:** 0 to -70 dB from reference level is calibrated; 1 to 20 dB/division in 1 dB steps; 8 divisions displayed

**Linear scale:** 8 divisions

**Scale units:** dBm, dBmV, dB $\mu$ V, volts, watts

### Reference level

**Range:** -114 to +30 dBm

**Resolution:** 0.01 dB for log scale; 0.12% of ref lev for linear

### Accuracy referred to -20 dBm reference level

**0 to -59.9 dBm:**  $\pm(0.5$  dB + input atten acc @ 50 MHz)

**-60 to -114 dBm:**  $\pm(1.25$  dB + input atten acc @ 50 MHz)

### Frequency response, referred to 300 MHz CAL OUT, preselector peaked

**Absolute:**  $\pm 2.0$  to  $+3.0$  dB

**Relative flatness:**  $\pm 1.5$  to  $+2.0$  dB

### Calibrator output

**Frequency:** 300 MHz  $\pm 30$  kHz

**Amplitude:** -20 dBm  $\pm 0.4$  dB

### Input attenuator

**Range:** 0 to 70 dB in 10 dB steps

#### Accuracy

**0 to 60 dB:** 0.5 dB at 50 MHz, ref to 10 dB atten

**70 dB:** 1.2 dB at 50 MHz, ref to 10 dB atten

### Resolution bandwidth (-3 dB nominal): 1 kHz to 3 MHz

**Switching uncertainty:**  $\pm 0.4$  dB, 3 kHz to 3 MHz RBW;  $\pm 0.5$  dB, 1 kHz

**Video bandwidth range:** 30 Hz to 1 MHz

**Log to linear switching:**  $\pm 0.25$  dB at reference level

**Display scale fidelity:**  $\pm 0.2$  dB/2 dB, 0 to -70 dB from ref lev, incremental;  $\pm 0.75$  dB, 0 to -60 dB from ref lev  $\pm 1.0$  dB; 0 to -70 dB from ref lev, maximum cumulative

**Linear accuracy:**  $\pm 3\%$  of reference level

### Ordering Information

HP 8590B spectrum analyzer (9 kHz to 1.8 GHz) \$9,590

HP 8592B spectrum analyzer (9 kHz to 22 GHz) \$19,640

Opt 001 75  $\Omega$  input impedance (HP 8590B only) \$0

Opt 003 card reader \$600

Opt 010 tracking generator 50 $\Omega$  \$3,900

(HP 8590B only)

Opt 011 tracking generator 75 $\Omega$  \$3,900

(HP 8590B only)

Opt 021 HP-IB interface \$600

Opt 023 RS-232 interface \$600

Opt H25 frequency extension to \$3,350

25 GHz (HP 8592B only)

Opt 1BH general export version \$0

# SIGNAL ANALYZERS

## Spectrum Analyzers, Performance Portable

HP 8591A, 8593A, 8594A, 8595A

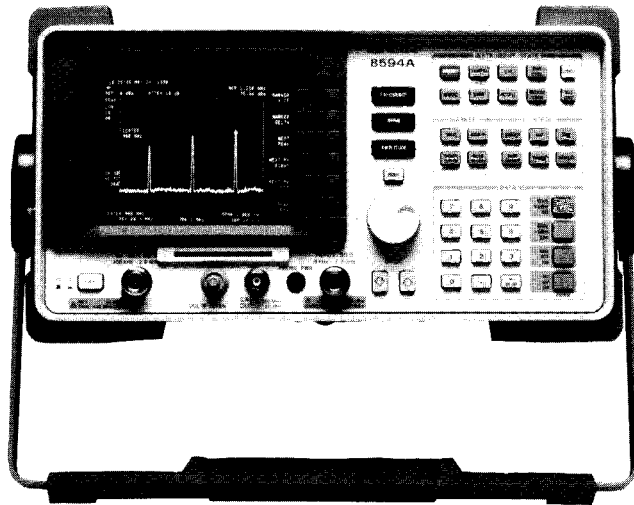

HP 8594A

### HP 8594A and 8595A Spectrum Analyzers

These new models offer expanded frequency ranges with the same frequency accuracy and variety of options associated with the HP 8591A. The HP 8594A has a frequency range of 9 kHz to 2.9 GHz and an amplitude range of  $-112$  to  $+30$  dBm. The HP 8595A has a frequency range of 9 kHz to 6.5 GHz with an amplitude range of  $-114$  to  $+30$  dBm. (For general export, both analyzers offer option 1BH, which does not display spans wider than 2.3 GHz.) Both instruments have an optional 2.9 GHz built-in tracking generator. In addition, each comes standard with a memory-card reader that enables you to load HP's custom measurement personalities, your own programs, or measurement data into the spectrum analyzer using 32-Kbyte memory cards.

### HP 8591A and 8593A Spectrum Analyzers

These portable spectrum analyzers offer frequency accuracy and a wide range of options for applications that demand higher performance. The HP 8591A has a frequency range of 9 kHz to 1.8 GHz and amplitude range of  $-115$  to  $+30$  dBm. The HP 8593A has a frequency range of 9 kHz to 22 GHz or 26.5 GHz with option 026, an internal preselector, and an amplitude range of  $-114$  to  $+30$  dBm. (For general export, the HP 8593A option 1BH does not tune above 18 GHz nor span greater than 2.3 GHz.) Both instruments have standard 7.5 ppm frequency accuracy that can be improved with an optional precision frequency reference to marker count accuracy of  $\pm 230$  Hz at 1 GHz or  $\pm 2.3$  kHz at 18 GHz.

### Standard Features

These performance analyzers share the same ease-of-use features found in the lower-cost HP 8590B and 8592B. (See page 174.) In addition, each performance portable comes with a built-in memory card reader that enables you to load HP's custom measurement personalities (see page 173) and measurement data into the spectrum analyzer using 32-Kbyte memory cards. A catalog function allows you to determine the exact content of information stored on your memory cards or within internal memory.

### Option Flexibility

For easy installation of a growing variety of options, a cardcage for circuit cards has been designed in each performance portable spectrum analyzer. All card options are retrofittable, so the options you need are always available. Circuit-card options include:

- AM/FM demodulator speaker to let you view and hear the signal.
- TV sync trigger to let you select any line of the TV field for measurement.
- Fast time-domain sweep to allow zero-span sweep rates to 20  $\mu$ s.
- Quasi-peak detector for EMC measurements.

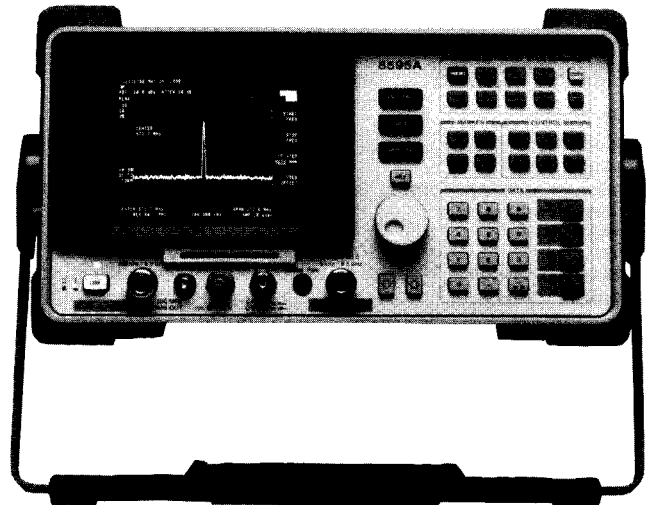

HP 8595A

### HP 8591A Specifications

#### General

**Temperature:**  $0^{\circ}$  to  $+55^{\circ}$  C operating;  $-40^{\circ}$  to  $+75^{\circ}$  C storage

**EMI compatibility:** CISPR Pub. 11 and FTZ 526/527/79

**Audible noise:**  $<37.5$  dBA pressure and  $<5.0$  Bels power (ISODP7779)

**Power requirements:** 86 to 127 or 195 to 250 Vrms, 47 to 66 Hz. 103 to 126 Vrms, 400 Hz  $\pm 10\%$

**Power consumption:**  $<300$  VA;  $<100$  watts

#### Frequency

**Range:** 9 kHz to 1.8 GHz (50  $\Omega$ ); 1 MHz to 1.8 GHz (75  $\Omega$ , opt. 001)

#### Reference

**Aging:**  $\pm 2 \times 10^{-6}$  /year

**Settability:**  $\pm 0.5 \times 10^{-6}$

#### Precision frequency reference (option 004)

**Aging:**  $\pm 1 \times 10^{-7}$  /year

**Settability:**  $\pm 1 \times 10^{-8}$

**Temperature stability:**  $\pm 1 \times 10^{-8}$

#### Frequency

#### Frequency readout accuracy (start, stop, center, frequency)

**Span  $\leq 10$  MHz:**  $\pm$ (freq readout x freq ref error + 3% of span + 20% of RBW + 100 Hz)

**Span  $\geq 10$  MHz:**  $\pm$ (freq readout x freq ref error + 3% of span + 20% of RBW)

**Marker count accuracy** (signal to noise ratio  $\geq 25$  dB, RBW/span  $\geq 0.01$ )

**Frequency span  $\leq 10$  MHz:**  $\pm$ (marker freq x freq ref error + counter res + 100 Hz)

**Frequency span  $> 10$  MHz:**  $\pm$ (marker freq x freq ref error + counter res + 1 kHz)

**Counter resolution:** selectable from 10 Hz to 100 kHz

#### Frequency span

**Range:** 0 Hz (zero span), 10 kHz to 1.8 GHz

**Accuracy:**  $\pm 2\%$  of span, span  $\leq 10$  MHz;  $\pm 3\%$  of span, span  $> 10$  MHz

#### Sweep time

**Range:** 20 ms to 100 s, span = 0 Hz or  $> 10$  kHz; 20  $\mu$ s to 100 s, span = 0 Hz (option 101)

**Accuracy:**  $\pm 3\%$ , 20 ms to 100 s;  $\pm 2\%$  20  $\mu$ s to  $< 20$  ms (opt 101)

**Sweep trigger:** free run, single, line, video, external

#### Stability

**Noise sidebands:**  $\leq 90$  dBc/Hz at  $> 10$  kHz offset from CW signal (1 kHz RBW, 30 Hz VBW, sample detector);  $\leq 100$  dBc/Hz at  $> 30$  kHz offset from CW signal (1 kHz RBW, 30 Hz VBW, sample detector)

**Residual FM:**  $< 250$  Hz p-p in 100 ms (1 kHz RBW, 1 kHz VBW)

**System-related sidebands:**  $< -65$  dBc at  $> 30$  kHz offset from CW



## HP 8591A Specifications (continued)

### Amplitude

**Amplitude range:** -115 to +30 dBm (50 ohm); -63 to +75 dBmV (75 ohm, opt 001)

Maximum safe input	50 ohm	75 ohm
Average cont power	+30 dBm (1 watt)	+75 dBmV (0.4 watts)
Peak pulse power	+30 dBm (1 watt)	+75 dBmV (0.4 watts)
dc	25 Vdc	100 Vdc

**Gain compression, > 10 MHz:**  $\leq 0.5$  dB, total power at input mixer = -10 dBm

**Displayed average noise level:**  $\leq 115$  to  $\leq 113$  dBm

### Noise level

#### Spurious responses

**Second harmonic distortion:** 5 MHz to 1.8 GHz,  $< -70$  dBc for -45 dBm tone at input mixer

**Third-order intermodulation distortion:** 5 MHz to 1.8 GHz,  $< -70$  dBc for two -30 dBm tones at input mixer and  $> 50$  kHz sep

**Other input-related spurious:**  $< -65$  dBc for  $\geq 30$  kHz offset from CW signal

#### Residual responses (input terminated and 0 dB attenuation)

**150 kHz to 1 MHz:**  $< -90$  dBm, 50 ohm

**1 MHz to 1.8 GHz:**  $< -90$  dBm, 50 ohm;  $< -38$  dBmV, 75 ohm

#### Display range

**Log scale:** 0 to -70 dB from ref lev is cal'd; 1 to 20 dB/div in 1 dB steps; 8 divisions displayed

**Linear scale:** 8 divisions

**Scale units:** dBm, dBmV, dBmicroV, volts, watts

**Marker readout resolution:** 0.05 dB, log scale; 0.07% of ref level, linear scale

**Fast sweep times for zero span (opt 101):** 20  $\mu$ s to 20 ms, 0.7% of ref level for linear scale

#### Reference level

**Range:** -115 to +30 dBm (50 ohm), -63 to +75 dBmV (75 ohm)

**Resolution:** 0.01 dB for log scale; 0.12 % of ref level for linear scale

**Accuracy, referred to -20 dBm ref level:** 0 dBm to -59.9 dBm,  $\pm(0.5$  dB + input atten acc @ 50 MHz); -60 dBm to -115 dBm,  $\pm(1.25$  dB + input atten acc @ 50 MHz)

#### Frequency response

**Absolute:**  $\pm 1.5$  dB, referred to 300 MHz CAL OUT

**Relative flatness:**  $\pm 1.0$  dB, referred to midpoint between highest and lowest response deviations

#### Calibrator output

**Frequency:** 300 MHz  $\pm(300$  MHz x freq ref error)

**Amplitude:** -20 dBm  $\pm 0.4$  dB (50  $\Omega$ ); +28.75 dBmV  $\pm 0.4$  dB (75  $\Omega$ , opt 001)

#### Input attenuator

**Range:** 0 to 60 dB in 10 dB steps

**Accuracy at 50 MHz, 10 dB atten:**  $\pm 0.5$  dB, 0 to 50 dB;  $\pm 0.75$  dB, 60 dB

**Resolution Bandwidth:** 1 kHz to 3 MHz,  $\pm 20\%$

**Switching uncertainty, ref to 3 kHz bandwidth:** 3 kHz to 3 MHz RBW,  $\pm 0.4$  dB; 1 kHz,  $\pm 0.5$  dB

**Video bandwidth range:** 30 Hz to 1 MHz

**Log to linear switching:**  $\pm 0.25$  dB at reference level

#### Display scale fidelity

**Log incremental accuracy:**  $\pm 0.2$  dB/2 dB, 0 to -70 dB from ref lev

**Log maximum cumulative:**  $\pm 0.75$  dB, 0 to -60 dB from ref level;  $\pm 1.0$  dB, 0 to -70 dB from ref level

**Linear accuracy:**  $\pm 3\%$  of reference level

## HP 8593A Specifications

### Frequency

**Frequency range:** 9 kHz to 22 GHz; 9 kHz to 26.5 GHz (option 026)

#### Frequency reference

**Aging:**  $\pm 2 \times 10^{-6}$  /year

**Stability:**  $\pm 5 \times 10^{-7}$

**Temperature stability:**  $\pm 5 \times 10^{-6}$

#### Precision frequency reference (Opt 004)

**Aging:**  $\pm 1 \times 10^{-7}$  /year

**Stability:**  $\pm 1 \times 10^{-8}$

**Temperature stability:**  $\pm 1 \times 10^{-8}$

**Frequency readout accuracy:**  $\pm$ (frequency readout x frequency reference error + 3% of span + 20% of RBW + 100 Hz sweep time) for spans  $\leq 10$  MHz;  $\pm$ (freq readout x freq ref error + 3% of span + 20% of RBW) for spans  $> 10$  MHz

**Marker count accuracy (signal-to-noise ratio  $\geq 25$  dB, RBW/span  $\geq 0.01$ ):**  $\pm$ (marker freq x freq ref error + counter res + 100 Hz) spans  $\leq 10$  MHz;  $\pm$ (marker freq x freq ref error + counter res + 1 kHz), spans  $> 10$  MHz

**Counter resolution:** Selectable from 10 Hz to 100 kHz

#### Frequency span

**Range:** zero span, (10 x N) kHz to 19.25 GHz, (10 x N) kHz to 23.75 GHz (opt 026)

**Accuracy:**  $\pm 2\%$  of span, span  $< 10$  MHz;  $\pm 3\%$  of span, span  $> 10$  MHz

#### Sweep time

**Range:** 20 ms to 100 s, span = 0 Hz or  $> 10$  kHz; 20  $\mu$ s to 100 s, span = 0 Hz (opt 101)

**Accuracy:**  $\pm 3\%$ , 20 ms to 100 s;  $\pm 2\%$ , 20  $\mu$ s to 20 ms

**Sweep trigger:** free run, single, line, video, external

#### Stability

**Noise sidebands:**  $\leq -95$  dBc/Hz + 20 log N at  $> 30$  kHz offset from CW signal

**Residual FM:**  $< (400 \times N)$  Hz peak-peak in 100 ms (1 kHz RBW, 1 kHz VBW)

**System-related sidebands:**  $< -65$  + 20 log N at  $> 30$  kHz offset from CW signal

**Comb generator:** 100 MHz fundamental freq;  $\pm 0.007\%$  freq accuracy

### Amplitude

**Amplitude range:** -114 to +30 dBm

**Maximum safe input level:** +30 dBm (1 watt, 7.1 Vrms), 0 Vdc

**Gain compression:**  $\leq 0.5$  dB (total power at input mixer = -10 dBm)

**Displayed average noise level:**  $\leq 114$  to  $< -92$  dBm

#### Spurious responses

**Second harmonic distortion:**  $< -70$  dBc for -40 dBm tone at input mixer, 10 MHz to 2.9 GHz;  $< -100$  dBc for -10 dBm tone power at input mixer or below displayed av noise lev),  $> 2.75$  GHz

**Third-order intermodulation distortion  $> 10$  MHz:**  $< -70$  dBc for two -30 dBm tones at input mixer and  $> 50$  kHz separation

**Other input-related spurious:**  $< -70$  dBc for applied freq  $\leq 18$  GHz;  $< -60$  dBc for applied freq  $\leq 22$  GHz

#### Display range

**Log scale:** 0 to -70 dB from ref lev is calibrated; 1 to 20 dB/div in 1 dB steps; 8 divisions displayed

**Linear scale:** 8 divisions

**Scale units:** dBm, dBmB, dBmicroV, volts, watts

#### Reference level

**Range:** -114 to +30 dBm

**Resolution:** 0.01 dB for log scale; 0.12% of ref lev for linear

**Accuracy (ref to -20 dBm ref level):**  $\pm(0.05$  dB + input atten acc @ 50 MHz), 0 dBm to -59.9 dBm;  $\pm(1.25$  dB + input atten acc @ 50 MHz), -60 to -114 dBm

#### Frequency response (ref to 300 MHz CAL OUT, preselector peaked)

**Absolute:**  $\pm 2.0$  to  $\pm 3.0$  dB

**Relative flatness:**  $\pm 1.5$  to  $\pm 2.0$  dB

#### Calibrator output

**Frequency:** 300 MHz  $\pm 30$  kHz

**Amplitude:** -20 dBm  $\pm 0.4$  dB

#### Input attenuator

**Range:** 0 to 70 dB in 10 dB steps

**Accuracy at 50 MHz, ref to 10 dB atten:** +0.5 dB, 0 to 60 dB; +1.2 dB, 70 dB

**Resolution bandwidth:** 1 kHz to 3 MHz,  $\pm 20\%$

**Switching uncertainty:**  $\pm 0.4$  dB, 3 kHz to 3 MHz RBW;  $\pm 0.5$  dB, 1 kHz

**Video bandwidth range:** 30 Hz to 1 MHz

**Log to linear switching:** +0.25 dB at reference level

**Display scale fidelity:**  $\pm 0.2$  dB/2 dB, 0 to -70 dB from ref lev, incremental;  $\pm 0.75$  dB, 0 to -60 dB from ref lev and  $\pm 1.0$  dB, 0 to -70 dB from ref lev, maximum cumulative

**Linear accuracy:**  $\pm 3\%$  of reference level

# SIGNAL ANALYZERS

## Spectrum Analyzers, Performance Portable and Accessory

HP 8591A, 8593A, 85901A

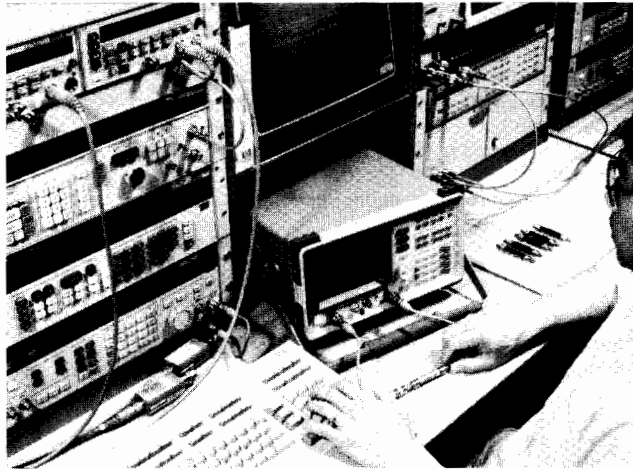

HP 8590 series RF spectrum analyzers have built-in tracking generator option

### HP 8591A, 8593A Specifications

#### Option 010 and 011 built-in tracking generators

Specifications apply to both HP 8590B and 8591A.

**Frequency range:** 50 ohm 75 ohm  
100 kHz to 1.8 GHz 1 MHz to 1.8 GHz

**Tracking drift** (10 kHz RBW, 30-minute warmup): 1.5 kHz/5 min, nominal

#### Output power level

Range:	50 ohm	75 ohm
HP 8591A	0 to -70 dBm	+42.8 to -27.2 dBmV
HP 8590B	0 to -15 dBm	+42.8 to +27.8 dBmV
Resolution	0.1 dB	0.1 dB

**Absolute accuracy:** ±1.0 dB, HP 8591A; ±1.5 dB, HP 8590B

#### Output vernier

**Range:** HP 8591A, 10 dB; HP 8590B, 15 dB

**Accuracy:** HP 8591A, ±0.75 dB; HP 8590B, ±1.0 dB

**Output flatness:** ±1.75 dB, HP 8591A ref to 300 MHz and 10 dB attenuation; ±1.75 dB 8590B

#### Output attenuator (HP 8591A only)

**Range:** 0 to 60 dB

**Switching accuracy:** ±0.8 dB or 2.5% of atten setting, whichever greater for max of 1.5 dB (ref to 10 dB atten setting)

**Repeatability:** ±0.2 dB, nominal

#### Dynamic range (difference bet max power out and f.g. feed-through)

>106 dB, nominal, 50 ohm; >100 dB, nominal, 75 ohm

**Tracking generator feedthrough:** <-106 dBm, 50 ohm; <-52.2 dBm, 75 ohm

#### Output VSWR

**0 dB attenuation:** 2.5:1

**10 dB attenuation (HP 8591A only):** 1.6:1

#### Ordering Information

	Price
HP 8591A spectrum analyzer (9 kHz to 1.8 GHz)	\$12,625
HP 8593A spectrum analyzer (9 kHz to 22 GHz)	\$24,805
HP 8594A spectrum analyzer (9 kHz to 2.9 GHz)	TBD
HP 8595A spectrum analyzer (9 kHz to 6.5 GHz)	TBD
Opt 001 75-ohm input (HP 8591A only)	\$0
Opt 004 precision frequency reference	+\$2,050
Opt 010 50-ohm built-in tracking generator (HP 8591A only)	+\$4,500
Opt 011 75-ohm built-in tracking generator (HP 8591A only)	+\$4,500
Opt 021 HP-IB interface	+\$600
Opt 023 RS-232 interface	+\$600
Opt 026 26.5 GHz frequency range extension (HP 8593A only)	+\$3,000
Opt 101 fast time-domain sweeps	+\$1,000
Opt 1BH general export version (HP 8593A, 8594A, 8595A)	\$0
Opt 102 AM/FM demodulator and TV sync trigger	+\$1,500
Opt 103 quasi-peak detector/AM-FM demodulator	\$1,910

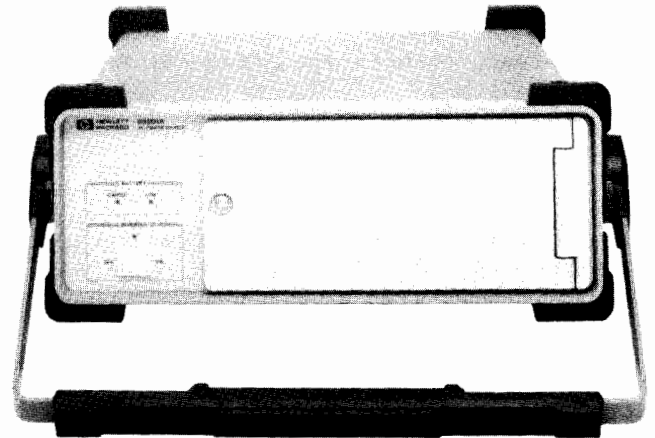

HP 85901A

### HP 85901A Portable ac Power Source

This small, easy-to-carry power source gives you ac power where and when you need it. Use it as a standalone battery or connect it to an external 12 Vdc source for even longer operation. As a standalone battery, the ac power source gives you over an hour of operation at 100 Watts continuous load. When the charge gets low, the power source shuts off automatically. It can be recharged in six hours or less. Over-voltage, short-circuit, and overload protection on the inverter output are built in. Also included are over-voltage protection on the inverter input and over-charge and over-discharge protection for the internal battery.

#### Specifications

**Input inverter voltage:** 10.8 to 14.5 Vdc

**Charger voltage:** 90 to 250 Vac auto selected

**Frequency:** 47 to 66 Hz

**Power consumption:** 122 VA maximum

#### Output

**Voltage:** 135 or 270 Vpeak + 5% rectangular waveform with 25% dead zone (115 or 230 Vrms ±5%)

**Frequency:** 60 Hz ±0.1%, crystal reference

**Max power:** 200 watts continuous

**Connectors:** two CEE22-V type; female

**Temperature:** 0° to 55° C, operating; -20° to 40° C storage with battery; -40° to 70° C storage without battery

**EMI:** conducted and radiated VDE 0871 level B

#### Battery

**Type:** sealed acid lead

**Voltage:** 12 Vdc, nominal

**Capacity:** 17 AMP-HR, nominal

#### Mechanical (nominal)

**Size:** 125 H x 337 W x 461 mm D

**Weight:** net, with battery, 14.2 kg (31.3 lb); without battery, 8.0 kg (17.7 lb); shipping, 16.3 kg (36.0 lb)

#### Ordering information

HP 85901A portable ac power source

**Extra power cord adapter for HP instruments**

HP 8120-5220

**General-purpose power cord adapters**

HP 8120-5210 European

HP 8120-5211 USA

HP 8120-5212 UK

☎ For same-day shipment, call HP DIRECT at 800-538-8787.

#### Price

\$1,120 ☎

\$17

\$55

\$55

\$55

# SIGNAL ANALYZERS

## Spectrum Analyzers, High-performance Portable

### HP 8560 Series

- Synthesized tuning
- Frequency counter
- Digital bandwidths
- AM/FM demodulator

- MIL-T-28800C rugged
- Optional precision frequency reference, tracking generator, mass memory, more
- One-year calibration cycle



HP 8563A



### HP 8560 Series Spectrum Analyzers

These portable spectrum analyzers are HP's highest performing portables. They combine MIL-rugged packaging, synthesized tuning, and HP's traditional ease of use as standard features.

The HP 8560A\* has a frequency range of 50 Hz to 2.9 GHz. A built-in tracking generator is optional. The HP 8561B\* extends from 50 Hz to 6.5 GHz. For higher, preselected frequency coverage, the HP 8562A and 8563A\* operate from 9 kHz to 22 GHz or to 26.5 GHz with option 026. Using HP 11974A series millimeter mixers, preselected coverage reaches 75 GHz, and with other mixers, unpreselected coverage can be extended to 325 GHz. (See page 187 for information on HP millimeter mixers.)

#### Rugged For Field Service

The HP 8560 series meets all MIL-T-28800C requirements, including those for temperature, pulse shock, and transit drop. These analyzers are warmed up and running in only five minutes. They fully meet specifications in temperatures from -10 degrees to +55 degrees C. They can withstand 30 g's of shock.

#### Narrow Digital Resolution Bandwidths

For fast, accurate measurements of closely spaced signals, the HP 8560A, 8561B, and 8563A feature digital 10-, 30-, and 100-Hz resolution bandwidths. These bandwidths allow the analyzers to sweep up

\*Contact your HP sales representative for information about options for general export.

to 20 times faster than do conventional analog bandwidths. Digital bandwidths also provide the spectrum analyzer CRT with a calibrated measurement range of 100 dB.

#### Improved Frequency Accuracy

An optional precision frequency reference improves frequency accuracy to 150 Hz at 1 GHz after a 15 minute warmup (1 year aging).

#### Specified Pulse Response

These portable analyzers easily capture and accurately display short-duration radar pulses. Specified pulse-digitization uncertainty is 1.25 dB and typical repeatability is 0.2 dB.

#### Accessories

A number of accessories increase the power and performance of the HP 8560 series spectrum analyzers.

- The HP 85640A portable tracking generator and the built-in tracking generator for the HP 8560A add component-test capability to 2.9 GHz.
  - The HP 85620A mass memory module adds extra memory and controller capability.
  - The HP 85710A digital radio measurement personality customizes the spectrum analyzer for digital radio measurements.
- For details on these options, see page 183.

# SIGNAL ANALYZERS

## Spectrum Analyzers, High-performance Portable

HP 8560A, 8561B, 8562A, 8563A

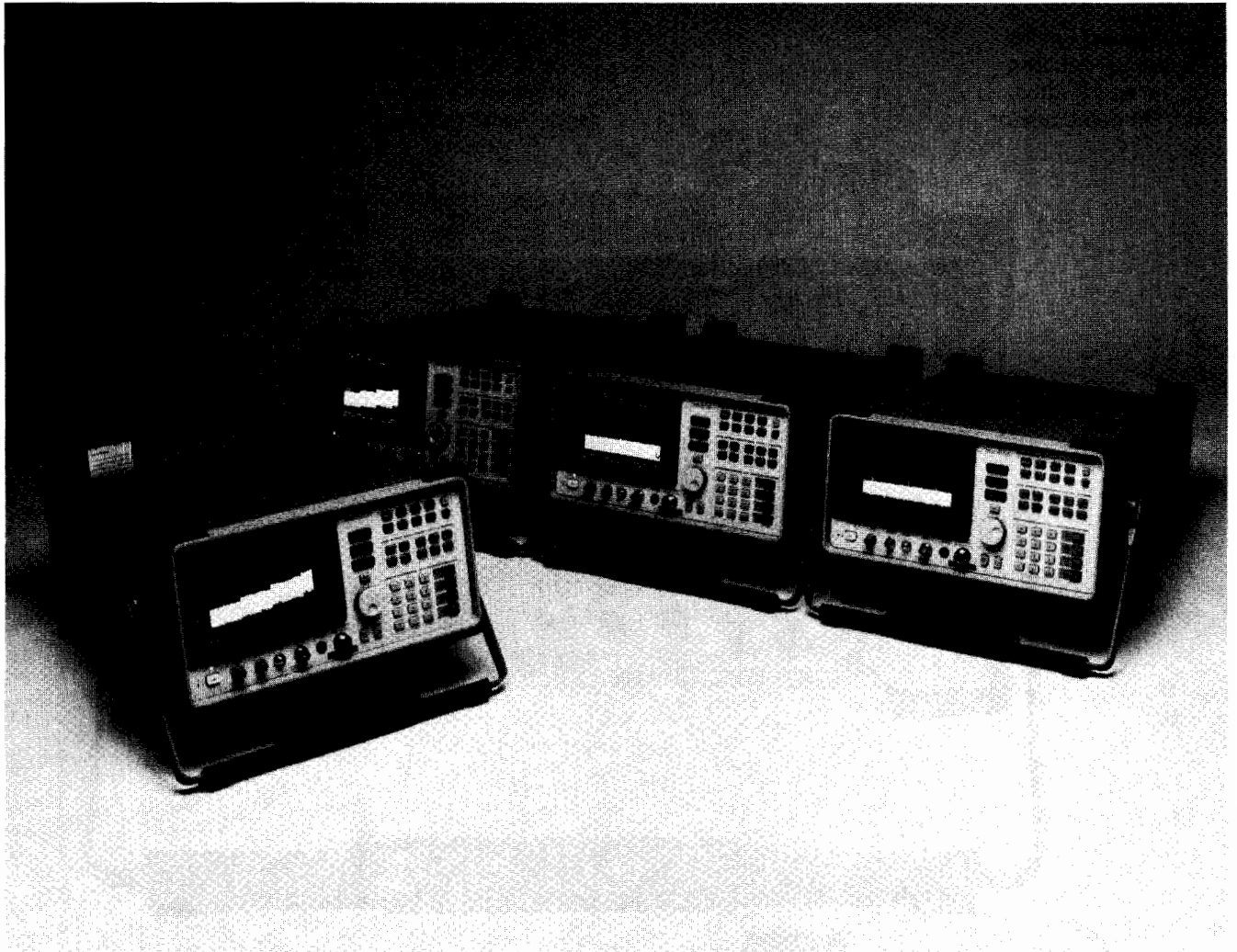

HP 8560A, 8561B, 8562A, 8563A

### HP 8560A and 8561B RF Spectrum Analyzers

The HP 8560A and 8561B offer excellent performance for RF design and service applications. The HP 8560A has a frequency range of 50 Hz to 2.9 GHz and the HP 8561B extends this range up to 6.5 GHz. Both have synthesized tuning for drift-free, accurate measurements. They also have sensitivity of  $-130$  dBm and digital bandwidths of 10, 30, and 100 Hz. Both analyzers meet MIL-T-28800C specifications for ruggedness.

Manual control is simple with an easy-to-use combination of hardkeys and softkeys that minimizes the number of keystrokes required to make measurements. Other measurement features include advanced marker capability and built-in AM and FM demodulators. Hardcopies of results are easily obtained using the analyzers' direct print and plot functions or by using a computer.

Scalar measurement capability is available by adding an optional built-in tracking generator to the HP 8560A or by using the HP 85640A portable tracking generator with either analyzer. For millimeter applications that don't require full microwave coverage, the HP 8560A and 8561B provide lower cost solutions. Both are compatible with HP 11970 series harmonic mixers and HP 11974 series preselected millimeter mixers. For very precise measurements, consider an optional precision frequency reference. It gives frequency accuracy of 150 Hz at 1 GHz. See page 183 for more information on options and accessories.

### HP 8562A and 8563A Microwave Spectrum Analyzers

The HP 8562A and 8563A extend the features and capabilities of the RF members of the HP 8560 series into the microwave frequency range. In addition, both the HP 8562A and the new HP 8563A have standard, preselected frequency ranges of 9 kHz to 22 GHz that can be extended to 26.5 GHz with option 026. Their internal preselector requires no adjustment after 30 minutes at room temperature. This means faster measurements, which can be especially important in automated testing. For millimeter-wave measurements, preselection can be extended to 75 GHz using the HP 11974 series millimeter mixers. Unpreselected frequency range can be extended to 110 GHz using the HP 11970A series mixers and to 325 GHz using mixers from other manufacturers. (See page 187 for more information on HP millimeter mixers.)

The HP 8562A has sensitivity of  $-110$  dBm. The HP 8563A has sensitivity of  $-120$  dBm and digital resolution bandwidths of 10, 30, and 100 Hz. The HP 8563A also features 128 Kbytes of battery-backed RAM that stores up to 100 traces and states; limit-line capability for defining test criteria; and a built-in clock/calendar for stamping traces and other output data. (These features can be added to the HP 8562A with the mass memory module accessory.) Enhance the capabilities of both the HP 8562A and the 8563A with any of the accessories described on page 183.

## Specifications

### Frequency

#### Frequency range

**HP 8560A:** 50 Hz to 2.9 GHz (dc-coupled); 100 kHz to 2.9 GHz (ac-coupled)

**HP 8561B:** 50 Hz to 6.5 GHz (dc-coupled); 100 kHz to 6.5 GHz (ac-coupled)

**HP 8562A:** 9 kHz to 22 GHz; 9 kHz to 26.5 GHz (option 026)

**HP 8563A:** 9 kHz to 22 GHz; 9 kHz to 26.5 GHz (option 026)

Harmonic mode (n)	Center frequency
1	9 kHz - 2.9 GHz
1	2.75 GHz - 6.46 GHz
2	5.86 GHz - 13.0 GHz
3	12.4 GHz - 19.7 GHz
4	19.1 GHz - 22 GHz
4	19 GHz - 26.5 GHz (opt 026)

**Frequency readout accuracy (start, stop, center, or marker):**  $\pm(\text{freq readout} \times \text{freq ref acc'y} + 5\% \times \text{span} + 15\% \times \text{RBW} + 10 \text{ Hz})$

**Counter resolution:** 10 Hz - 1 MHz (HP8562A, selectable); 1Hz - 1MHz (HP 8560A, 8561B, 8563A selectable)

**Marker counter accuracy (S/N  $\geq$  25 dB):**  $\pm(\text{marker freq} \times \text{freq ref acc'y} + 50 \text{ Hz} \times n + 1 \text{ LSD})$

**Delta counter accuracy (S/N  $\geq$  25 dB):**  $\pm(\text{delta freq} \times \text{freq ref acc'y} + 100 \text{ Hz} \times n + 2 \text{ LSD})$

#### Frequency reference accuracy (after 5-min warmup)

**HP 8560A, 61B, 62A Standard:**  $< 4 \times 10^{-6}/\text{yr}$  (includes aging, temp drift, settability)

**Option 003 precision frequency reference (standard on HP 8563A):**  $< 0.13 \times 10^{-6}/\text{yr}$  (includes aging, temp drift, settability, 15-min warmup)

#### Residual FM (zero span)

**HP 8560A and 8561B:**  $< 10 \text{ Hz p-p}$  in 20 ms ( $< 2 \text{ Hz p-p w/opt 003}$ )

**HP 8562A:**  $< 50 \text{ Hz} \times n \text{ p-p}$  in 100 ms ( $< 2 \text{ Hz} \times N \text{ p-p w/opt 003}$ )

**HP 8563A:**  $< 2 \text{ Hz} \times N \text{ p-p}$

#### Spectral purity

**Noise sidebands:**  $< (-100 + 20 \log n) \text{ dBc/Hz}$  at 30 kHz offset

#### Frequency span

##### Range

**HP 8560A:** 0 Hz, 100 Hz to 2.9 GHz

**HP 8561B:** 0 Hz, 100 Hz to 6.5 GHz

**HP 8562A:** 0 Hz, 2.5 kHz  $\times$  N to 19.25/23.75 GHz (opt 026)

**HP 8563A:** 0 Hz, 100 Hz  $\times$  N to 19.25/23.75 GHz (opt 026)

**Accuracy:**  $\leq \pm 5\%$

#### Resolution bandwidth ( $-3 \text{ dB}$ )

##### Range

**HP 8560A, 8561B and 8563A:** 10 Hz - 1 MHz in a 1,3,10 sequence, and 2 MHz

**HP 8562A:** 100 Hz - 1 MHz in a 1,3,10 sequence, and 2 MHz

##### Accuracy

**HP 8560A, 8561B and 8563A:**  $\pm 10\%$  (10 Hz to 300 kHz);  $\pm 25\%$  (1 MHz, 2 MHz)

**HP 8562A:**  $\pm 30\%$  (100 Hz);  $\pm 10\%$  (300 Hz to 300 kHz);  $\pm 25\%$  (1 MHz, 2 MHz)

##### Selectivity ( $-80 \text{ dB}/-3 \text{ dB}$ )

**HP 8560A, 8561B and 8563A:**  $< 5:1$  (RBW  $\leq$  100 Hz);  $< 15:1$  (RBW  $>$  100 Hz)

**HP 8562A:**  $< 15:1$

#### Video bandwidth

**Range:** 1 Hz - 3 MHz in a 1,3,10 sequence

#### Amplitude Range

**Amplitude range:** +30 dBm to displayed average noise level

#### Maximum safe input

**Average continuous power:** +30 dBm (1 W) with input atten  $>$  10 dB

**Peak pulse power:** +50 dBm (100 W) with input atten  $\geq$  30 dB for  $< 10 \mu\text{sec}$  pulse width and  $< 1\%$  duty cycle

**dc:** 0 Volts

#### Display range

**Display:** 10 x 10 division graticule

**Calibration:** log = 10,5,2, and 1 dB per division; linear = 10% of reference level/division

**Reference level range:** log =  $-120$  to  $+30 \text{ dBm}$  in 0.1 dB steps; linear =  $2.2 \mu\text{Volts}$  to  $7.07 \text{ Volts}$  in 1% steps

**Input attenuation range:** 0 to 70 dB in 10 dB steps

#### Dynamic Range

##### Maximum dynamic range

###### Compression to noise

**HP 8560A:** 125 dB

**HP 8561B and 8563A:** 128 dB

**HP 8562A:** 118 dB

###### Signal to distortion, harmonic

**HP 8560A:** 81 dB

**HP 8561B and 8563A:** 81 dB ( $< 2.9 \text{ GHz}$ ), 110 dB ( $\geq 2.9 \text{ GHz}$ )

**HP 8562A:** 76 dB ( $< 2.9 \text{ GHz}$ ), 105.5 dB ( $\geq 2.9 \text{ GHz}$ )

###### Signal to distortion, intermodulation

**HP 8560A:** 90 dB

**HP 8561B and 8563A:** 90 dB ( $< 2.9 \text{ GHz}$ ), 92 dB ( $\geq 2.9 \text{ GHz}$ )

**HP 8562A:** 83 dB ( $< 2.9 \text{ GHz}$ ), 86 dB ( $\geq 2.9 \text{ GHz}$ )

**Displayed average noise level (minimum RBW, 0 dB input attenuation, 1 Hz video BW, no signal at input)**

Frequency	HP 8560A	HP 8561B	HP 8562A	HP 8563A
10 kHz	-103 dBm	-103 dBm	-90 dBm	-103
100 kHz	-110 dBm	-110 dBm	-100 dBm	-110
1 MHz - 2.9 GHz	-130 dBm	-130 dBm	-120 dBm	-130
2.75 GHz - 6.46 GHz		-131 dBm	-121 dBm	-131
5.86 GHz - 13.0 GHz			-110 dBm	-120
12.4 GHz - 19.7 GHz			-105 dBm	-115
19.1 GHz - 22.0 GHz			-100 dBm	-110

**1 dB gain compression:**  $-5 \text{ dBm}$  at input mixer (10 MHz - 2.9 GHz);  $-3 \text{ dBm}$  at input mixer ( $> 2.75 \text{ GHz}$ )

**Spurious responses (signals generated by analyzer due to input signals):** for mixer level  $< -40 \text{ dBm}$ ,  $> 60 \text{ dB}$  below input signal for frequencies  $< 6.46 \text{ GHz}$

##### Second harmonic distortion

Frequency	Mixer Level	HP 8560A	HP 8561B	HP 8562A/8563A
50 Hz - 10 MHz	-40 dBm	-60 dBc	-60 dBc	
10 MHz - 2.9 GHz	-40 dBm	-72 dBc	-72 dBc	-72 dBc
$> 2.75 \text{ GHz}$	-10 dBm		-100 dBc	-100 dBc

**Third-order intermodulation (two  $-30 \text{ dBm}$  signals at mixer):**  $-64 \text{ dBc}$ , 50 Hz - 10 MHz (HP 8560A and 8561B);  $-70 \text{ dBc}$ , 10 MHz - 2.9 GHz;  $-75 \text{ dBc}$ ,  $> 2.75 \text{ GHz}$  (HP 8561B, 8562A, 8563A)

**Image, multiple, and out-of-band responses:**  $< -70 \text{ dBc}$ , 10 MHz - 22 GHz;  $< -60 \text{ dBc}$ , 10 MHz - 22 GHz

**Residual responses (no signal at input, 0 dB input atten):**  $< -90 \text{ dBm}$ ,  $> 200 \text{ kHz}$

#### Amplitude Accuracy

##### Frequency response (relative)

**HP 8560A:**  $\pm 1.0 \text{ dB}$  (dc-coupled)

**HP 8561B:**  $\pm 1.0 \text{ dB}$  (dc-coupled, 50 Hz - 2.9 GHz);  $\pm 1.5 \text{ dB}$  (dc-coupled, 2.75 - 6.5 GHz)

**HP 8562A/8563A**

Frequency Range	HP 8562A/8563A
9 kHz - 2.9 GHz	$\pm 1.0 \text{ dB}$
2.75 - 6.46 GHz	$\pm 1.5 \text{ dB}$
5.86 - 13.0 GHz	$\pm 2.0 \text{ dB}$
12.4 - 19.7 GHz	$\pm 3.0 \text{ dB}$
19.1 - 22.0 GHz	$\pm 3.0 \text{ dB}$
19.1 - 26.5 GHz (opt 026)	$\pm 3.0 \text{ dB}$



# SIGNAL ANALYZERS

## Spectrum Analyzers, High-performance Portable (cont'd)

HP 8560A, 8561B, 8562A, 8563A

**Calibrator accuracy:**  $\pm 0.3$  dB

**IF gain uncertainty:**  $\pm 1$  dB for 0 dBm to  $-80$  dBm reference level

**Scale fidelity:**  $\pm 0.4$  dB/4 dB to a maximum of  $\pm 1.5$  dB over 0 - 90 dB range; linear,  $\pm 3\%$  of reference level

**Input attenuator switching accuracy (with 20 - 70 dB settings referenced to 10 dB):**  $< 2.9$  GHz  $\pm 0.6$  dB/10 dB step,  $\pm 1.8$  dB max

**Resolution bandwidth switching uncertainty:**  $\pm 0.5$  dB referenced to 300 kHz BW

**Pulse digitization uncertainty (pulse-response mode, PRF  $> 720$ /sweep time)**

**Log (peak to peak):** 1.25 dB (RBW  $\leq 1$  MHz), 3 dB (RBW = 2 MHz)

**Linear (peak to peak):** 4% of ref level (RBW  $\leq 1$  MHz); 12% of ref level, (RBW = 2 MHz) nominal standard deviation 0.2 dB

### Sweep

#### Sweep time

**Range:** 50  $\mu$ s to 60 s (zero span); 50 ms to 100 s (span  $> 0$ )

**Sweep trigger:** free run, line, single, video, external

### Demodulation

**Modulation type:** AM and FM

**Audio output:** speaker and phone jack with volume control

### Inputs and Outputs (All values are nominal)

#### Front-panel connectors

**RF input:** Precision type-N female, impedance 50 ohms

**VSWR:**  $< 1.5:1$  for  $< 2.9$  GHz and  $\geq 10$  dB input atten;  $< 2.3:1$  for  $> 2.9$  GHz and  $\geq 10$  dB input atten

**LO emission level (average):** with 10 dB input atten,  $< -80$  dBm

**Second IF input:** SMA female, frequency 310.7 MHz; NF 7 dB

**First LO output:** SMA female, impedance 50 ohms; freq range 3.0000 - 6.8107 GHz; amplitude  $+16.5$  dBm  $\pm 2$  dB (20° - 30° C);  $+14.5$  dBm  $\pm 2$  dB (HP 8560A opt 002)

**Calibrator output:** BNC female, impedance 50 ohms

#### Rear-panel connectors

**10 MHz reference (input/output):** BNC female, impedance 50 ohms; input range  $-2$  to  $+10$  dBm

**Video output:** BNC female, impedance 50 ohms (dc-coupled)

**LO sweep/0.5 V per GHz output:** shared BNC female, impedance 2,000 ohms (dc-coupled); LO sweep output 0 to  $+10$  V (no load)

**External trigger input:** BNC female, impedance  $> 10,000$  ohms; trigger level, rising edge of TTL level

#### HP-IB

**Interface functions:** SH1, AH1, T6, TE0, L4, LE0, SR1, RL1, PP1, PC1, DT1, C1, C28

**Direct plotter outputs:** HP 7440A, 7470A, 7475A, 7550A

**Printers:** HP 3630A PaintJet, HP 2225A ThinkJet; other printers with IEEE 488 interface may work

### General Specifications

#### Environmental

**Military specifications:** meets MIL-T-28800C, Type III, Class 3, Style C

**Calibration interval:** 1 year

**Warmup:** 5 minutes from ambient conditions

**Temperature:**  $-10^\circ$  to  $+55^\circ$  C, operating;  $-62^\circ$  to  $+85^\circ$  C, not operating

**Humidity:** 95% at  $40^\circ$  C for 5 days

**Altitude:** 15,000 ft, operating; 50,000 ft, not operating

**Rain resistance:** drip-proof at 16 liters/hour/square foot

**Vibration:** 0.059 inch p-p excursion (5 - 15 Hz); 0.039 inch p-p excursion (15 - 25 Hz); 0.020 inch p-p excursion (25 - 55 Hz)

**Pulse shock:** half sine, 30 g's for 11 ms duration

**Transit drop:** 8-inch drop on 6 faces and 8 corners

**Electromagnetic compatibility:** conducted and radiated interference in compliance with CISPR publication 11 (1985) and FTZ 526/527/79. Meets MIL-STD 461B, Part 4, with exceptions noted below

**Conducted emissions:** CE01 (narrowband), 1 - 15 kHz only; CE03 (narrowband), full limits; CE03 (broadband), 20 dB relaxation from 15 - 100 kHz

**Conducted susceptibility:** CS01, full limits; CS02, full limits; CS06, full limits

**Radiated emissions:** RE01, 15 db relaxation to 28 kHz and exceptioned from 28 - 50 kHz; RE02, full limits  $< 1$  GHz

**Radiated susceptibility:** RS01, full limits; RS02, exceptioned; RS03, limited to 1 V/meter from 14 kHz - 1 GHz with 20 dB relaxation at IF frequencies

### Power requirements

**115 Vac operation:** voltage 90 - 140 V rms; current 3.2 A rms Max; frequency, 47 - 440 Hz

**230 Vac operation:** voltage 180 - 250 V rms; current 1.8 A rms Max; frequency 47 - 66 Hz

**Maximum power dissipation:** 180 Watts

**Nominal audible noise:** 5.0 Bels power at room temp (ISO DP7779)

### Nominal weight

**HP 8560A:** 18.2kg (40lb)

**HP 8561B, 8562A and 8563A:** 20 kg (44 lb)

**Size:** 163H x 325W x 427mmD (nominal, without handle, feet, or cover)

### Option 002 Built-in Tracking Generator (HP 8560A only)

#### Frequency

**Frequency range:** 300 kHz - 2.9 GHz

**Tracking drift:** useable in 1 kHz RBW after 5-minute warmup; useable in 300 Hz RBW after 30-minute warmup

**Minimum useable RBW:** 300 Hz

#### Amplitude

**Output level:**  $-10$  to  $+1$  dBm

**Resolution:** 0.1 dB

#### Accuracy

**Vernier:**  $\pm 0.20$  dB/dB,  $\pm 0.5$  dB max (25° C + 10° C)

**Absolute:**  $\pm 0.75$  dB

**Level flatness:**  $\pm 2.0$  dB

**Return loss:** 10 dB

**Dynamic range:** 96 dB at 300 kHz - 1 MHz; 116 dB at 1 MHz - 2.7 GHz; 111 dB at 2.7 - 2.9 GHz

**Power sweep:** 10 dB range, 0.1 dB resolution

#### Input/output

**RF output (front panel):** type-N, 50-ohm nominal

**Ext ALC input (rear panel):** BNC female; use with negative detector

### Ordering Information

	Price
HP 8560A RF spectrum analyzer	\$24,695
HP 8561B RF spectrum analyzer	\$29,795
HP 8562A microwave spectrum analyzer	\$37,200
HP 8563A microwave spectrum analyzer	\$43,500

#### Options

Opt 001 second IF output	+\$850
Opt 002 built-in tracking generator (HP 8560A only)	+\$6,140
Opt 003 precision frequency reference	+\$2,050
Opt 026 extended frequency coverage to 26.5 GHz (HP 8562A and 8563A)	+\$3,280

Opt T01 TEMPEST compliant (HP 8562A only)

Opt 908 rackmount kit without handles \$+\$400

Opt 909 rackmount kit with handles \$+\$450

Opt 915 support documentation package \$+\$360

Opt 916 extra quick reference guide (HP 8560A, 8561B and 8563A) or extra pocket operating guide (HP 8562A) \$+\$25

Opt W30 extended repair service. See page 723.

for HP 8560A \$+\$625

for HP 8561B \$+\$700

for HP 8562A \$+\$835

for HP 8563A \$1,050

Opt W32 calibration service. See page 723.

for HP 8560A \$+\$965

for HP 8561B \$+\$1,355

for HP 8562A \$+\$1,230

for HP 8563A \$1,415

HP 85620A mass memory module \$2,055

Opt T01 TEMPEST compliant

HP 85629B test and adjustment module \$2,055

HP 85640A tracking generator \$7,675

HP 85700A 32 Kbyte RAM memory card \$100

HP 85710A digital radio measurement personality \$770

HP 85901A portable ac power source \$1,120

☎ For same-day service, call HP DIRECT at 800-538-8787..

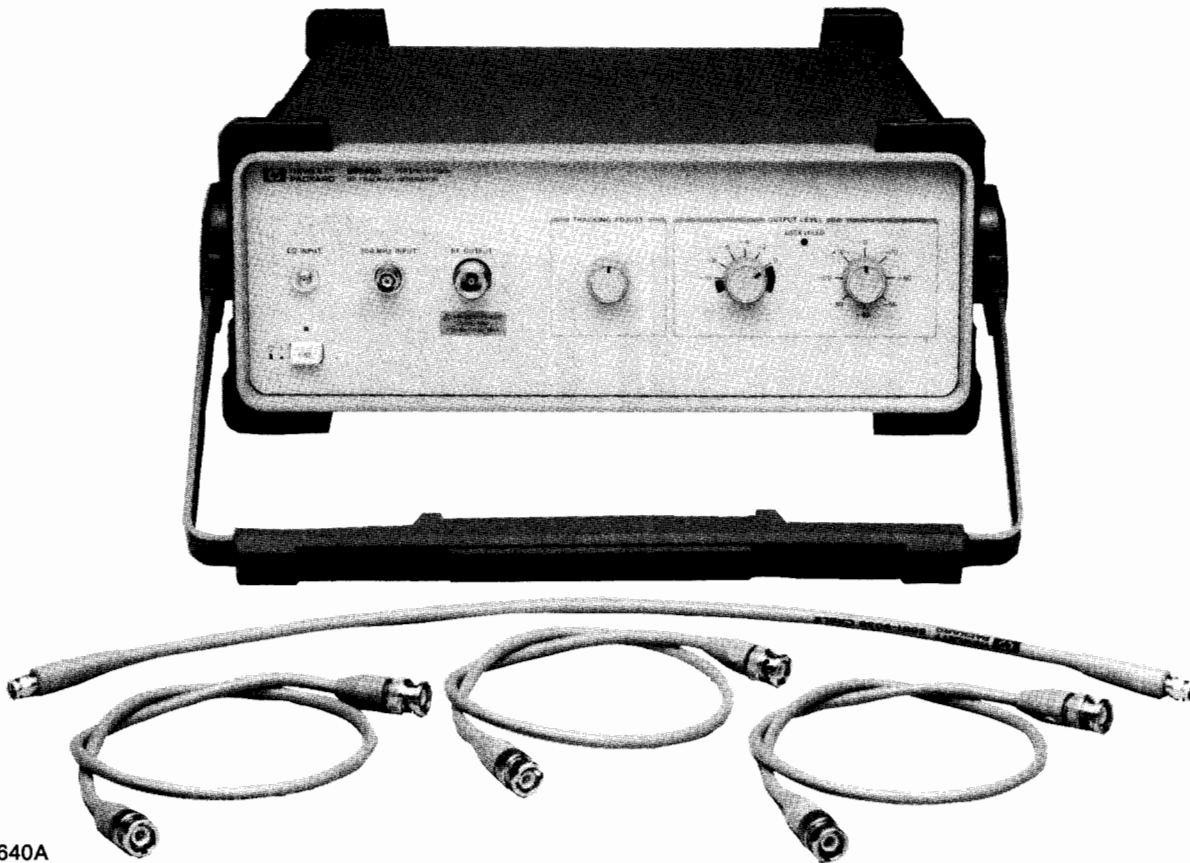

HP 85640A

### HP 85640A Portable Tracking Generator

Similar in capability to the built-in tracking generator for the HP 8560A, this portable model provides the HP 8560 series spectrum analyzers with scalar measurement capability from 300 kHz to 2.9 GHz. This instrument is ideal for testing and adjusting transceiver components in the field. The combined spectrum analyzer and tracking generator system has dynamic range greater than 100 dB.

### HP 85620A Mass Memory Module

This plug-in module adds extra memory and computer capability to the HP 8560 series analyzers. It allows you to create complex measurement routines that can be saved as single-key measurements using downloadable programming. Your DLPs can be stored on 32-Kbyte memory cards or in the 128 Kbytes of battery-backed RAM in the mass memory module. You can also store traces with state information and create and store limit lines. A clock/calendar and automatic save and execute functions allow you to set the analyzer for unattended, automatic measurements when specified criteria are met.

### HP 85629B Test and Adjustment Module

This accessory creates a new approach to servicing your spectrum analyzer. The module plugs into the rear panel of an HP 8560 series analyzer and automates high-level diagnostics, self-tests, and adjustment procedures. It performs more than 1,000 troubleshooting measurements. Readjustments are fast and accurate because the module controls internal analyzer settings as well as external test equipment.

### HP 85710A Digital Radio Measurement Personality

This program, stored on a memory card, customizes the HP 8562A and 8563A microwave spectrum analyzers for digital-radio measurements. It contains five agency masks for testing to US FCC, UK, and FRG specifications. A compare-to-mask function allows you to characterize spectral emissions. Other functions include mean-power-level, transient-analysis-monitoring, and frequency-response measurements. You can also create and store your own custom masks.

### HP 85901A Portable AC Power Source

If ac power is not available, operate the HP 8560 series spectrum analyzers using this portable power supply. It operates as a standalone battery, or it can be connected to an external Vdc source for longer use. The power source recharges in less than six hours. See page 178 for more information.

### Ordering Information

HP 85620A mass memory module	\$2,055
HP 85629B test and adjustment module	\$2,055
HP 85640A portable tracking generator	\$7,675 ☎
HP 85700A 32 Kbyte RAM memory card	\$100
HP 85710A digital radio measurements personality	\$770
HP 85901A portable ac power source	\$1,120 ☎
☎ For same-day shipment, call HP DIRECT at 800-538-8787.	

© 1992 Hewlett-Packard Company  
 HP 85640A Portable Tracking Generator  
 Model 85640A-001  
 Printed in the U.S.A.  
 183

# SIGNAL ANALYZERS

## Spectrum Analyzers, Bench, 100 Hz to 325 GHz

HP 8566B, 8567A, 8568B

- 100 Hz to 325 GHz coverage with synthesizer accuracy
- 10 kHz to 1.5 GHz coverage at a lower price
- 100 Hz to 1.5 GHz coverage with counter accuracy
- 2 to 22 GHz preselected range
- Trace markers with amplitude and frequency readout
- 16 Kbytes of user RAM for trace data or custom routines



HP 8566B



HP 8568B

### HP 8566B, 8567A, 8568B Spectrum Analyzers

The HP 8566B, HP 8567A, and HP 8568B are high-performance spectrum analyzers for bench and ATE system use. The HP 8566B is the highest performance analyzer of the three, with a frequency range from 100 Hz to 22 GHz that can be extended to 325 GHz using external mixers. The HP 8567A and the HP 8568B are RF spectrum analyzers with frequency coverage to 1500 MHz. See pages 185 and 186 for specification summaries on all three analyzers.

Each analyzer is designed around its own internal bus and controlled by its own microcomputer to yield significant improvements in operational and data processing features, as well as flexibility under computer control. Each analyzer has 16K bytes of user RAM for storing trace data, instrument states, or custom downloadable programs (DLPs).

#### Performance

The exceptional frequency stability of both the HP 8566B and the HP 8568B makes it possible to measure with 10 Hz resolution bandwidths. This narrow resolution bandwidth yields sensitivities to  $-135$  dBm in both instruments. Excellent frequency stability, sensitivity, and frequency-reference accuracy combine to allow very accurate measurement of small signals in the presence of large ones.

For applications that don't require the high performance of the HP 8568B, the HP 8567A offers the same speed, versatility, and automatic operation capability at a lower price. Resolution bandwidths as narrow as 1 kHz yield sensitivities as low as  $-115$  dBm.

#### Flexibility

These spectrum analyzers fit into many applications, such as EMC testing (see page 196), broadband signal surveillance, and component stimulus-response testing. The HP 8444A option 059 tracking generator adds stimulus-response capabilities to the RF models for a minimal cost.

#### Usability

The instrument control settings are conveniently notated on the CRT for easy reference. Functions are activated by pressing a front-panel key, then selecting the function value using the knob, step keys,

or numeric keyboard. To maintain a calibrated display, certain functions are automatically coupled in the analyzer. For example, resolution bandwidth, video bandwidth, and sweep time are automatically adjusted by the instrument when the frequency span is reduced.

Up to four tunable display markers are available to aid in measuring and analyzing signals. Two markers can be used to make relative measurements by displaying their amplitude and frequency difference. Marker information allows you to step between evenly spaced portions of a spectral display (such as signal harmonics) or "zoom-in" on a selected portion of the spectrum.

Analyzer control settings can also be saved in the non-volatile memory of the analyzer. Different operators can recall these settings to make consistent, repeatable measurements.

#### Versatile CRT Display and Plotting Capabilities

All displayed information resides in the analyzer's digital memory, which refreshes the CRT at a flicker-free rate. Multiple traces can be displayed to measure residual FM or drift, or to conduct real-time surveillance over a wide frequency range.

By adding an HP-IB plotter, hard copy of all information on the display of the analyzer can be made for analysis, documentation, or presentation. Plots can be produced directly or with the aid of a controller.

#### Custom Softkey Programming

Custom measurement routines can be created to meet your specific requirements. These programs can be created on an external controller or from the front-panel controls of the instrument and then stored in the non-volatile memory of the analyzer. Custom programming allows you to create complex measurement routines that can be stored and executed using a single softkey. This capability makes the analyzer a custom instrument that is more efficient for your specific tasks.

#### System Software

BASIC system software for the HP 8566B, 8567A, and 8568B spectrum analyzers provides high-level routines to aid in developing custom programs for specific measurement applications. Capabilities include automatic computation and setting of analyzer functions to insure optimum measurement performance.



# SIGNAL ANALYZERS

## Spectrum Analyzers, Bench, 100 Hz to 1500 MHz

HP 8568B, 8567A

185

### Specification Summary

FREQUENCY	HP 8568B	HP 8567A
Frequency Range	100Hz - 1500MHz - DC coupled 100kHz - 1500MHz - AC coupled	10kHz - 1500MHz
Frequency Span	100Hz to 1500MHz + zero span	100Hz to 1500MHz + zero span
Frequency Reference Accuracy		
Aging Rate	$<2.5 \times 10^{-7}$ /year	$<5 \times 10^{-6}$ /year
Temperature Stability	$<7 \times 10^{-9}$ (0-55°C)	$<1 \times 10^{-8}$ (5-55°C)
Resolution Bandwidth (-3dB)	10Hz - 3MHz in 1,3,10 sequence	1kHz - 3MHz in 1,3,10 sequence
Video Bandwidth	1Hz - 3MHz in 1,3,10 sequence	1Hz - 3MHz in 1,3,10 sequence
Residual FM (pk to pk, <100kHz span)	<3Hz (res BW $\leq$ 30Hz)	<100Hz (res BW 1kHz)
Drift (per minute of sweep time, after one hour warm-up)	<10Hz (freq span $\leq$ 100kHz)	<100Hz (freq span $\leq$ 100kHz)
Phase Noise (30kHz offset, 1Hz Res BW)	-107dBc	-105dBc
<b>AMPLITUDE</b>		
Amplitude Range	-135 to +30dBm	-115 to +30dBm
Log Display Range	1,2,5, or 10dB/div for 10,20,50 or 90dB display	1,2,5, or 10dB/div for 10,20,50 or 90dB display
Scale Fidelity - incremental	$\pm 0.1$ dB/dB; 0-90dB	$\pm 0.1$ dB/dB; 0-80dB
cumulative (20-30°C)	$\leq \pm 1.0$ dB; 0-80dB $\leq \pm 1.5$ dB; 0-90dB	$\leq \pm 1.0$ dB; 0-80dB $\leq \pm 1.5$ dB; 0-90dB
Calibrator Uncertainty	$\pm 0.3$ dB	$\pm 0.3$ dB
Frequency Response (input atten $\geq$ 10dB)	$\pm 1.5$ dB, 100Hz - 1500MHz/ $\pm 1$ dB 100 kHz-1500 MHz	$\pm 1$ dB, 10kHz - 1500MHz
Spurious Responses (<-40dBm at mixer)	<-70dBc (<10MHz input sig) <-75dBc (>10MHz input sig)	<-70dBc
Second Harmonic Distortion (-30dBm at mixer)	<-70dBc (sig $\geq$ 10MHz) <-60dBc (sig <10MHz)	<-70dBc (sig $\geq$ 10MHz) <-60dBc (sig < 10MHz)
Third Order Intercept (TOI)	+10dBm (sig > 10MHz)	+10dBm (sig >10MHz)
Residual Responses (at 1MHz) (0dB attn, no input signal)	<-105dBm	<-100dBm
Gain Compression ( $\leq$ 10dBm at mixer)	<0.5dB	<1.0dB
Displayed Average Noise Level (0dB attn, 1Hz Video BW)	<-112dBm, 500Hz-1MHz (10Hz res BW) <-135dBm, >1MHz (10Hz res BW)	<-92dBm, 50kHz-1MHz (1kHz res BW) <-115dBm, >1MHz (1kHz res BW)
Sweep time - Zero Span	1 $\mu$ s to 1500 s	1 $\mu$ s to 1500 s
Sweep	20 ms to 1500 s	20 ms to 1500 s

### General Specifications (Apply to both 8568B and 8567A unless noted)

#### Environmental

**Temperature:** Operation, 8568B, 0 to 55° C; 8567A, 5° to 55° C Storage, -40° to +75° C

**EMI:** Conducted and radiated interference is within the requirements of MIL-STD-461B, CE03/part 2 and RE02/part 7, and the requirements of CISPR pub. 11 and FTZ 526/1979

**Power Requirements:** 100, 120, 220, or 240 VAC (+ 5%, - 10%), 50-60 Hz or 400 Hz with Option 400

#### Warm-up Time

**Operation:** 30 minutes from cold start

#### Frequency Reference

**8568B:** frequency within  $1 \times 10^{-8}$  of final stab freq within 30 minutes

**8567A:** frequency within  $5 \times 10^{-5}$  of final stab freq within 30 minutes

**Size (w/out handles):** 292.2 H x 425.5 W x 558.8 mm D (11" x 16.75" x 22")

**Weight: net,** 45 kg (100 lb)

#### Inputs

RF in (Type N), RF in (BNC, 8568B only), Ext Freq Ref in, Ext Sweep Trig in

**Quasi-Peak:** Video in, IF in

#### Outputs

Cal out, Display X, Y, & Z out, Horiz Sweep out, Video out, Penlift out, 21.4 MHz IF, 1st LO, Freq Ref, Probe Power out (8568B only)

**Quasi-Peak:** Video out, IF out

### Ordering Information

HP 8568B spectrum analyzer	\$37,195
HP 8567A spectrum analyzer	\$29,035
Opt 001 75 ohm (BNC) RF input	+\$204
Opt 016 installed EMI receiver functions	+\$255
Opt 044 add HP 8444A Opt 059 Tracking Generator (8567A only)	+\$5,200
Opt W30 extended repair service. See page 723	
8568B	+\$1,060
8567A	+\$670
Opt W32 calibration service. See page 723	
8568B	+\$3,610
8567A	+\$2,860
Opt 400 400 Hz power line frequency operation	
8568B	+\$410
8567A	+\$715
Opt 010 rack mount slide kit	+\$460
Opt 908 rack flange kit (instrument w/out handles)	
8568B	+\$66
8567A	+\$153
Opt 913 rack flange kit (instrument w/handles)	
8568B	+\$71
8567A	+\$153
Opt 910 extra operating and test and adjustment manuals	+\$355
Opt 915 troubleshooting and repair manual	
8568B	+\$204
8567A	+\$225
Opt 462 impulse bandwidths for EMI measurements (8568B only)	+\$2,040
Opt 080 8568B information card in Japanese	\$0
Opt 081 8568B information card in French	\$0

# SIGNAL ANALYZERS

## Spectrum Analyzer, Bench, 100 Hz to 325 GHz

HP 8566B

### HP 8566B Specification Summary

#### Frequency

**Frequency Range:** 100 Hz to 22 GHz with internal mixer; extendable to 110 GHz with HP 11970 external mixers, to 75 GHz with HP 11974 series preselected mixers, and to 325 GHz with mixers from other suppliers

**Frequency Span:** 0 Hz, 100 Hz to 22 GHz, variable in approximately 1% increments

**Frequency Reference Accuracy:** Aging rate;  $< 1 \times 10^{-9}$ /day,  $< 2.5 \times 10^{-7}$ /year

**Temperature Stability:**  $< 7 \times 10^{-9}$ , 0 to 55° C

**Resolution Bandwidth:** 3 dB bandwidths of 10 Hz to 3 MHz in a 1, 3, 10 sequence

**Bandwidth Selectivity, 60 dB/3 dB ratio:**  $< 11:1$ , 30 Hz to 3 kHz;  $< 13:1$ , 10 kHz & 30 kHz;  $< 15:1$ , 100 kHz to 3 MHz

**Bandwidth Shape:** synchronously tuned, 4- or 5-pole filters, approximately Gaussian shape

**Video Bandwidth:** 1 Hz to 3 MHz in a 1, 3, 10 sequence

**Residual FM (typical peak to peak, fundamental mixing mode):**  $< 0.2$  Hz, frequency span  $< 5$  kHz;  $< 5$  Hz, frequency span  $< 100$  kHz;  $< 200$  Hz, frequency span  $< 5$  MHz

**Drift (typical, after one hour warm-up at stabilized temperature):**  $< 10$  Hz/minute of sweep time, frequency span  $\leq 100$  kHz;  $< 500$  Hz/minute of sweep time, frequency span 100 kHz to 5 MHz;  $< 5$  kHz/minute of sweep time, frequency span  $\geq 5$  MHz

#### Spectral Purity

**Noise sidebands (center frequency 100 Hz to 5.8 GHz):** 320 Hz offset,  $< -80$  dBc/Hz; 1 kHz offset,  $< -85$  dBc/Hz; 10 kHz offset,  $< -90$  dBc/Hz; 100 kHz offset,  $< -105$  dBc/Hz

#### Amplitude

**Amplitude Range (dBm):**  $-134$  to  $+30$ , 1 MHz-2.5 GHz;  $-132$  to  $+30$ , 2-5.8 GHz;  $-125$  to  $+30$ , 5.8-12.5 GHz;  $-119$  to  $+30$ , 12.5-18.6 GHz;  $-114$  to  $+30$ , 18.6-22 GHz

**Log Display Range:** 1, 2, 5, or 10 dB/division for 10, 20, 50, & 90 dB displays, respectively

**Scale Fidelity:**  $\pm 0.1$  dB/dB over 0 to 80 dB display (20°-30° C);  $< \pm 1.0$  dB max over 0 to 80 dB display;  $< \pm 1.5$  dB max over 0 to 90 dB display

**Calibrator Uncertainty:**  $\pm 0.3$  dB

**Frequency Response (10 dB input atten):** 100 Hz to 2.5 GHz,  $\pm 0.6$  dB; 2 to 12.5 GHz,  $\pm 1.7$  dB; 12.5 to 20 GHz,  $\pm 2.2$  dB; 20 to 22 GHz,  $\pm 3.0$  dB

#### Dynamic Range

**Spurious Responses:**  $< -70$  dBc for mixer levels  $\leq -40$  dBm

#### Second Harmonic Distortion

**Unpreselected, mixer levels  $\leq -40$  dBm:**  $< -70$  dBc, 100 Hz to 2.5 GHz;  $< -80$  dBc, 50 to 700 MHz.

**Preselected, mixer levels  $\leq -10$  dBm:**  $< -100$  dBc, 2 to 22 GHz

**Third Order Intercept (TOI):**  $> +5$  dBm, 100 Hz to 5 MHz;  $> +7$  dBm, 5 MHz to 5.8 GHz;  $> +5$  dBm, 5.8 to 18.6 GHz

**Image Responses:**  $< -70$  dBc, 100 Hz to 18.6 GHz;  $< -60$  dBc, 18.6 to 22 GHz

**Multiple Responses:**  $< -70$  dBc, 100 Hz to 22 GHz

**Out-Of-Band Responses:**  $< -60$  dBc, 2 to 22 GHz

**Residual Responses (0 dB input atten, no input signal):**  $< -100$  dBm, 100 Hz to 5.8 GHz;  $< -95$  dBm, 5.8 to 12.5 GHz;  $< -85$  dBm, 12.5 to 18.6 GHz;  $< -80$  dBm, 18.6 to 22 GHz

**Gain Compression ( $\leq -5$  dBm at mixer):**  $< 1.0$  dB, 100 Hz to 22 GHz

**Displayed Average Noise Level (0 dB input atten, 10 Hz Res BW)**

**Unpreselected:**  $< -95$  dBm, 100 Hz to 50 kHz;  $< -112$  dBm, 50 kHz to 1 MHz;  $< -134$  dBm, 1 MHz to 2.5 GHz

**Preselected:**  $< -132$  dBm, 2 to 5.8 GHz;  $< -125$ , 5.8 to 12.5 GHz;  $< -119$  dBm, 12.5 to 18.6 GHz;  $< -114$  dBm, 18.6 to 22 GHz

#### Sweep Time

**Zero Span:** 1  $\mu$ sec to 1500 seconds

**Swept:** 20 msec to 1500 seconds

**Accuracy:**  $\pm 10\% \leq 200$  second sweep times;  $\pm 30\% > 200$  second sweep times

**Trigger:** Free run, line, video, external, continuous, and single

### General Specifications

#### Environmental

**Temperature:** Operation; 0 to 55° C Storage;  $-40$  to  $+75$ ° C

**Humidity:** Operating  $< 95\%$  RH, 0 to 40° C

**EMI:** Conducted and radiated interference is within the requirements of MIL-STD-461C, Part 7, REO2 and CEO3 (Air Force), and the requirements of CISPR pub. 11, and Messempefaenger-postferuegun 526/527/79

**Power Requirements:** 100, 120, 220, or 240 VAC ( $+5\%$ ,  $-10\%$ ), 50 to 60 Hz or 400 Hz with Option 400

**Warm-up Time Operation:** 30 minutes from cold start (0 to 55° C)

**Frequency Reference:** frequency within  $1 \times 10^{-8}$  of final stab frequency within 30 minutes

**Size (w/out handles):** 279.2 H x 425.5 W x 598.5 mm D (11" x 16.75" x 23.56")

**Weight:** net, 50 kg (112 lb)

#### Inputs

RF in (Type N), Ext Freq Ref in, Ext Sweep Trig in

**Quasi-Peak:** Video in, IF in

#### Outputs

Cal out, 1st LO out, IF out, Sweep + Tune out, Display X, Y, Z out, Horiz Sweep out, Video out, Penlift out, 21.4 MHz IF out, Freq Ref, 10 MHz

**Quasi-Peak:** Video out, IF out

### Ordering Information

	Price
HP 8566B spectrum analyzer	\$61,500
Opt 016 installed EMI receiver functions	+\$255
Opt 400 400 Hz power-line frequency operation	+\$410
Opt W30 extended repair service. See page 723	+\$1,150
Opt W32 calibration service. See page 723	+\$3,900
Opt 462 impulse bandwidths for EMI measurements	+\$2,040
Opt 010 rack mount slide kit	+\$460
Opt 908 rack flange kit (instrument w/out handles)	+\$66
Opt 913 rack flange kit (instrument w/handles)	+\$71
Opt 910 extra operating and test and adjustment manuals	+\$355
Opt 915 troubleshooting and repair manual	+\$204
Opt 031 German operating manual	\$0
Opt 080 information card in Japanese	\$0
Opt 081 information card in French	\$0
Opt E69 internal MATE test module adapter	\$4,500

# SIGNAL ANALYZERS

## Millimeter Mixers

### HP 11970 Series and 11974 Series

187

- Preselected mixers to eliminate signal identification
- State-of-the-art technology
- Easier automated measurements

- Low conversion loss
- Individually amplitude-calibrated
- No bias or tuning adjustments
- High 100 mW safe input level

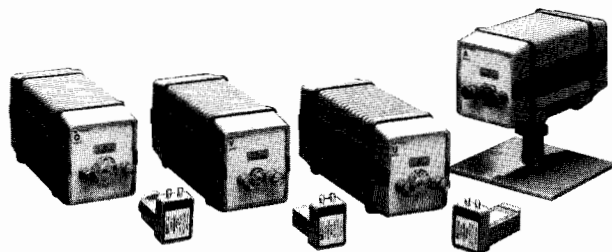

HP 11970, 11974 series mixers

### HP 11974 Series Preselected Millimeter Mixers

Eliminate the need for signal identification at millimeter frequencies. The HP 11974 series mixers are preselected from 26.5 to 75 GHz for faster, easier testing of millimeter devices and systems. Preselection reduces mixer overload from broadband signals and reduces radiation of local oscillator harmonics back to the device under test. Equipment operators can quickly locate true signals, and software development for automated measurements is greatly simplified.

HP 11974 series preselected mixers are available in four bands:

HP Model <sup>1</sup>	Frequency range (GHz)	Sensitivity (displayed Avg. noise level/10 Hz) (dBm)	Calibration accuracy (dB)	Image rejection (dB)	1 dB gain compression (dBm)
HP 11974A	26.5-40	-111	<±2.3	-54	+6
HP 11974Q	33-50	-106	<±2.3	-50	+0
HP 11974U	40-60	-109	+±2.6	-50	+0
HP 11974V	50-75	-100	<±4.5	-50	+3

<sup>1</sup>Specifications apply when connected to the HP 8566B or 70000 series spectrum analyzers.

These mixers feature advanced barium-ferrite technology and come with a stand-alone power supply. They are particularly useful for broadband millimeter signal analysis, millimeter electromagnetic-interference (EMI) measurements, and unattended monitoring of millimeter signals.

### Compatibility

Upgrade kits are available to assure compatibility of HP 8560A, HP 8561A/B, HP 8562A/B, HP 8566A/B spectrum analyzers and the HP 70907A external mixer interface module. Consult your HP sales representative to determine requirements. All versions of HP 8563A spectrum analyzers and HP 70907B external mixer interface modules are fully compatible with the HP 11974 series.

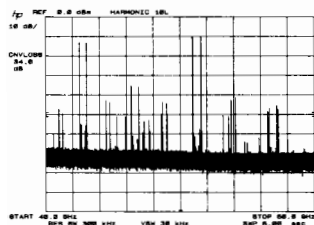

50-75 GHz sweep without preselection

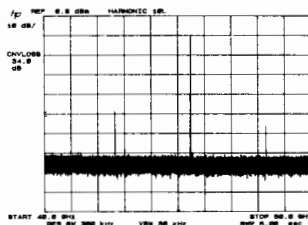

50-75 GHz sweep using new HP 11974 series mixer

### HP 11970 Series Harmonic Mixers

The HP 11970 series waveguide mixers are general-purpose harmonic mixers. They employ a dual-diode design to achieve flat frequency response and low conversion loss. These are achieved without external dc bias or tuning stubs. Manual operation and computer-controlled hardware operation is simplified because mixer bias and tuning adjustment are not required.

HP 11970 series harmonic mixers are available in six bands:

HP model	Frequency range (GHz)	LO harm number	Conversion loss (dB)	Noise level (dB) 1 kHz RBW	Freq <sup>1</sup> response (dB)	Gain compression (dBm)
HP 11970K	18-26.5	6+	24	-105	±1.9	-3
HP 11970A	26.5-40	8+	26	-102	±1.9	-5
HP 11970Q	33-50	10+	28	-101	±1.9	-7
HP 11970U	40-60	10+	28	-101	±1.9	-7
HP 11970V	50-75	14+	40	-92	±2.1	-3
HP 11970W	75-110	18+	46	-85	±3.0	-1

<sup>1</sup>Frequency of the mixers is reduced by 1 dB for LO range of 14 to 18 dBm.

### Compatibility

The HP 11970 series mixers extend the frequency range of the HP 8561B, 8562A, and 8563A portable spectrum analyzers; of the HP 8566B spectrum analyzer (used with the HP 11975A amplifier); and of the HP 70000 modular measurement system (used with the HP 70907A/B external mixer interface module).

### HP 11970 and 11974 Series Specifications

**IF range:** dc to 1.3 GHz

**LO amplitude range:** +14 to +18 dB; +18 optimum

**Calibration accuracy:** +2.0 dB for HP 11970 series with optimum LO amplitude

**Typical RF input SWR:** <2.2:1, <3.0:1 for HP 11974 series

**Bias requirements:** none

**Typical odd-order harmonic suppression:** >20 dB (does not apply to HP 11974 series)

**Maximum CW RF input level:** +20 dBm (100 mW), +25 dBm for HP 11974 series

**Maximum peak pulse power:** 24 dBm (250 mW) with < 1 μsec pulse (avg. power = +20 dBm)

**Bandwidth:** 100 MHz minimum (HP 11974 series only)

**Environmental:** meets MIL-T-28800C, Type III, Class 3, Style C

**IF/LO connectors:** SMA female

**TUNE IN Connector:** BNC

**LO range:** 3.0 to 6.1 GHz

### Ordering Information

HP 11974A 26.5 TO 40 GHz preselected mixer \$14,000

HP 11974Q 33 to 50 GHz preselected mixer \$14,500

HP 11974U 40 to 60 GHz preselected mixer \$15,000

HP 11974V 50 to 75 GHz preselected mixer \$16,000

Opt 003 delete power supply (HP 11974 series only) -\$500

HP 11970K 18 to 26.5 GHz mixer \$1,790

HP 11970A 26.5 to 40 GHz mixer \$1,850

HP 11970Q 33 to 50 GHz mixer \$2,000

HP 11970T 18 to 40 GHz mixers and case \$3,600

Opt 001 add 40 to 60 GHz mixers (HP 11970 series only) +\$2,200

Opt 002 add 33 to 50 GHz mixers (HP 11970 series only) +\$1,950

HP 11970U 40 to 60 GHz mixers \$2,260

HP 11970V 50 to 75 GHz mixers \$2,720

HP 11970W 75 to 110 GHz mixers \$3,070

HP 11970 \$475

Opt 009 mixer connection set adds three 1-meter low-loss SMA cables, wrench, allen driver for any HP 11970 series mixer. Carrying case with storage space for cables and tools included. +\$475

HP 11969A carrying case for one to five HP 11970-series mixers, SMA cables, and tools \$620

HP 11975A 2 to 8 GHz amplifier \$4,810

HP 281A/B coaxial to waveguide adapters

R281A 26.5-40 GHz, 2.4 mm (f) \$850

R281B 26.5-40 GHz, 2.4 mm (m) \$800

Q281A 33-50 GHz, 2.4 mm (f) \$850

Q281B 33-50 GHz, 2.4 mm (m) \$800

# SIGNAL ANALYZERS

## Spectrum Analyzers

### Accessories

- 2 to 8 GHz wideband frequency coverage
- 40 milliwatt (+16 dBm) output power
- Adjustable, calibrated power



HP 11975A

### HP 11975A Microwave Amplifier

This general-purpose, leveled microwave amplifier has a frequency range of 2 to 8 GHz and an adjustable output of +6 to +16 dBm. In addition, the amplifier has an adjustable bias current output port that supplies a maximum of +11 milliamps at +3 volts. This bias current is needed by some external harmonic mixers. The amplifier has automatic leveling control (ALC) that can be switched on and off. An 'unleveled' light indicates that ALC is off.

Use the HP 11975A as an LO driver for the HP 11970 and 11974 series harmonic mixers to achieve maximum performance.

#### Specifications

##### Frequency

**Range:** 2 to 8 GHz

**Flatness:** +1.0 dB, +0.5 dB typical

##### Input and output

Minimum small-signal gain:	Frequency	Gain
	2.0 to 4.5 GHz	15 dB
	4.5 to 6.1 GHz	11 dB
	6.1 to 8.0 GHz	9 dB

**Noise figure:** 13 dB typical

**Output power:** +6 to +16 dBm adjustable

**Input:** SMA connector (f)

**Output:** SMA connector (f)

**Maximum output:** +30 dBm, +35 Vdc

**VSWR:** 1.7:1 (ALC on)

**Reverse isolation:** >40 dB

**Spectral purity:** TOI = +25 dBm typical

##### General specifications

**Power requirements:** 100, 120, 220, or 240 Vac, 48 to 440 Hz, 36 VA

**Environmental:** MIL-T-28800C, Type III, Class 5, Style E

**EMI:** CE03 and RE02 of MIL-STD 461A and CISPR Pub 11 (1975)

**Weight:** net, 3.904 kg (8.6 lb); shipping, 5.45 kg (12.2 lb)

**Size:** 102 H x 213 W x 297 mm D (4.0" x 8.4" x 11.7")

#### Ordering Information

HP 11975A amplifier

Opt 001 type N connectors

Opt W30 extended repair service. See page 724.

Opt W32 calibration service. See page 724.

HP P/N 5061-0072 rackmount kit for HP 11975A

#### Price

HP 11975A amplifier	\$4,810
Opt 001 type N connectors	\$102
Opt W30 extended repair service. See page 724.	\$115
Opt W32 calibration service. See page 724.	\$165
HP P/N 5061-0072 rackmount kit for HP 11975A	\$53

### HP 85640A Portable Tracking Generator

This portable, MIL-rugged tracking generator adds scalar-analysis capability from 300 kHz to 2.9 GHz to an HP 8560 series portable spectrum analyzer. It allows measurement of gain, frequency response, compression, flatness, and return loss on components and sub-systems. A built-in attenuator gives an output power range of -80 to 0 dBm. See page 183.

### HP 8444A Option 059 Tracking Generator

Used with the HP 8568B RF spectrum analyzer, this model adds stimulus-response measurement capability for a minimal cost. It allows swept-frequency testing of components and subsystems. Frequency range is 500 Hz to 1.5 GHz.

### HP 85901A Portable AC Power Source

This is HP's first portable power source for test instruments. It provides 200 watts of continuous power using an internal battery, external battery, or other 12 Vdc source. See page 183.

### HP 11867A and 11693A Limiters

Protect the input circuits of spectrum analyzers, counters, amplifiers, and other instruments from high power levels with minimal effect on measurement performance. The HP 11867A RF limiter (dc to 1.8 GHz) reflects signals up to 10 watts average power and 100 watts peak power. Insertion loss is less than 0.75 dB. The HP 11693A microwave limiter (100 MHz to 12.4 GHz, usable to 18 GHz) guards against input signals over 1 milliwatt up to 1 watt average power and 10 watts peak power.

### HP 11694A 75-ohm Matching Transformer

From 3 to 500 MHz, this transformer allows measurements in 75-ohm systems while retaining amplitude calibration with a 50-ohm spectrum analyzer input. VSWRs are less than 1.2; insertion loss is less than 0.75 dB. See pages 174 and 176 for 75-ohm versions of the HP 8590B and 8591A spectrum analyzers.

### HP 8721A Directional Bridge

Frequency range is 100 kHz to 100 MHz. This bridge is used in return-loss measurement made with a swept source such as a tracking generator and spectrum analyzer. It has 6 dB insertion loss and is 6 dB coupled to the auxiliary arm. Frequency response is  $\pm 0.5$  dB (0.1 to 110 MHz); directivity is greater than 40 dB (1 to 110 MHz); load-port match is greater than 30 dB; maximum input power is +20 dBm. Standard model is 50-ohm with a 75-ohm option.

### HP 85024A High Frequency Probe

In-circuit measurements are easy with this probe. Input capacitance of only 0.7 pF shunted by 1 M $\Omega$  resistance permits high-frequency probing without adverse loading of the circuit under test. Excellent frequency response and unity gain guarantee highly accurate swept measurements. High sensitivity and low distortion levels allow measurements taking advantage of full analyzer dynamic range. This probe is directly compatible with many HP RF spectrum and network analyzers.

#### Ordering Information

	Price
HP 85640A portable tracking generator	\$7,675
Opt 908 rackmount kit	\$400
Opt 909 rackmount kit with handles	\$450
Opt 910 extra operation/service manual	\$50
Opt W30 extended repair service. See page 723.	\$195
Opt W32 calibration service. See page 723.	\$360
HP 8444A opt 059 tracking generator	\$6,145
HP 85901A portable ac power source	\$1,120
HP 11867A RF limiter	\$490
HP 11693A microwave limiter	\$620
HP 11694A 75-ohm matching transformer	\$205
HP 8721A directional bridge	\$400
HP 85024A high frequency probe	\$1,900
☎ For same-day shipment, call HP DIRECT at 800-538-8787.	

- Automated, reconfigurable measurement systems
- Highest performance from RF through lightwave

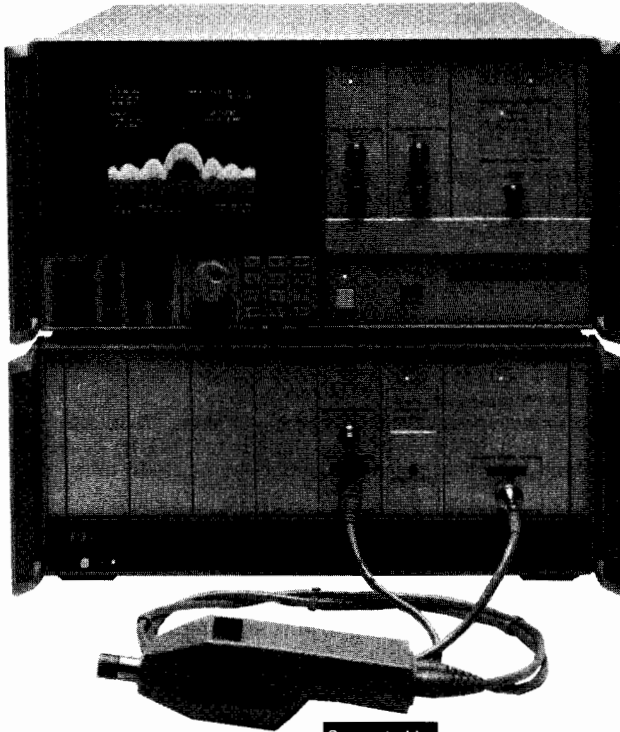

HP 71210C and 70100A



### HP 70000 Modular Measurement System

This growing family of high-performance instruments includes spectrum analyzers, power meters, bit-error-rate testers, lightwave signal analyzers, digitizers, signal generators, and more. Every HP 70000 modular measurement system is fully automatic and can be configured to meet your changing test needs. The powerful system architecture has been optimized for measurement applications from RF through lightwave. You can combine the rugged mainframes and display/control units with the many modules available from HP, or you can design your own system modules. Hewlett-Packard has released to the public domain all patent rights to the modular measurement system, including those to the modular system interface bus (MSIB). To aid those designing modules, HP has MSIB module interface software. The source code provides a common communication interface to MSIB for MMS modules.

The HP 70000 series is part of Hewlett-Packard's Measurement Systems Architecture (MSA), which consists of test instrumentation, software, and computers—all based on open industry standards. (See page 602.) The modular measurement system is HP's higher frequency companion to the modular VXIbus system, which emphasizes lower frequency analog and digital measurements. Alone or in combination with VXIbus or traditional IEEE-488 rack instruments, the HP 70000 series is ideal for use in automated test systems.

#### System Expansion and Control

One HP 70000 series system can include many instruments and up to 255 modules. Mainframes supply power, cooling, electromagnetic compatibility, and communications to the modules. A powerful system interface bus, the MSIB, manages protocol among these modules for efficient internal communication. Control of individual instruments in the system is handled over the HP-IB if no display is present. Adding a display, however, gives you manual control. Up to four instruments can be viewed simultaneously as all of the instruments are making measurements. Also, for remote control, a standalone display may be separated from the mainframe by up to 1.2 km. The flexibility of this control system is unsurpassed in the microwave industry.

- Part of the HP Measurement Systems Architecture

### New Modular Measurement System Catalog

Complete descriptions of systems, modules, and components for the HP 70000 modular measurement system can be found in the new MMS catalog. For a free copy, contact your local HP Sales Office listed on page 737.

### HP 70000 Series Spectrum Analyzers

Three standard spectrum analyzer systems combine high-performance capabilities with ease-of-use features. The HP 71100C RF spectrum analyzer has a frequency range of 100 Hz to 2.9 GHz\*. The HP 71200C microwave system extends from 100 Hz to 22 GHz with options for preselection and 26.5 GHz frequency. The HP 71210C microwave spectrum analyzer offers the highest performance from 100 Hz to 22 GHz\*. For millimeter frequency coverage, the HP 70907B external interface module provides measurement capability to 325 GHz.

All three spectrum analyzers are synthesized and have an oven-controlled reference oscillator for 0.1 ppm frequency accuracy over both temperature and time. Amplitude measurements can be made accurately anywhere within the 90-dB calibrated display range. The local oscillator module adds greater processing speed and improved phase noise of -108 dBc/Hz (10 kHz offset). Both the HP 71100C and 71210C have -133 dBm sensitivity. The HP 71210C, used with the microwave preamplifier module, has a receiver-quality noise floor and -154 dBm sensitivity.

These analyzers also feature a color display with a color editor and special color palettes. The mainframe houses a custom hardkey panel for your most commonly used functions, downloadable programming capability, and a memory card reader. You can copy data directly to a printer, plotter, or external disk or store it internally.

### Add-on Capabilities

A wide range of capabilities can be added to the basic HP spectrum analyzers, including scalar analysis, CW phase, and power meter measurements. HP offers modular RF and microwave preamplifiers and tracking generators, and a modular power meter, digitizer, and vector voltmeter. See page 192 for application information and page 193 for a complete list of modules and accessories.

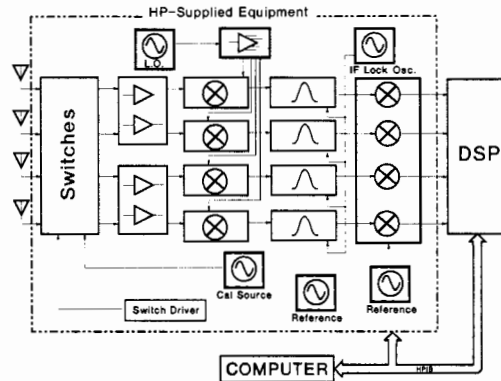

Along with standard analyzer systems, you can configure modules for your own application, such as this direction-finding receiver.

\*For general export, a modified version of this spectrum analyzer, option 18H, does not tune beyond 18 GHz nor span greater than 2.3 GHz.

# SIGNAL ANALYZERS

## Modular Measurement System

HP 70000 Series

### HP 70000 Series Spectrum Analyzers, Common Specifications, Characteristics

#### Frequency

##### Frequency readout accuracy

Span  $\leq$  10 MHz x N\*:  $\pm$ [(freq readout x freq ref accuracy) + 1.0% of span + 10 Hz]

Span  $>$  10 MHz x N\*:  $\pm$ [(freq readout x freq ref accuracy) + 1.5% of span + 10 Hz], sweep  $\geq$  20 ms

##### Frequency span

Range: 1 Hz to maximum frequency in 0.5% increments and 0 Hz Accuracy

Span  $\leq$  10 MHz:  $\pm$ [1% of span + (span x freq ref accuracy)]

Span  $>$  10 MHz:  $\pm$ 1.5% of span, sweep  $\geq$  50 ms;  $\pm$ 2.5% of span, sweep  $\geq$  20 ms;  $\pm$ 4.0% of span, sweep  $\geq$  10 ms

##### Spectral Purity

Noise Sidebands: 100 Hz (or 50 kHz) to 2.9 GHz at 10kHz offset, -108dBc/Hz; 2.7 GHz to 22/26.5 GHz at 30 kHz offset, -108 dBc/Hz + 20 log N\*

##### Frequency reference

w/HP 70310A      w/o HP 70310A

Accuracy

Aging       $< 1 \times 10^{-7}$ /year       $< 3 \times 10^{-6}$ /year

Temperature drift       $< 7 \times 10^{-9}$        $< 1 \times 10^{-5}$

##### Resolution bandwidth

Range: (1,3,10 sequence and 10% increments except 3 to 10 kHz)

10 Hz - 300 kHz (HP 70902A); 100 kHz - 3 MHz (HP 70903A)

Accuracy:  $\pm$ 20%

Selectivity ( $-60$  dB/ $-3$  dB):  $< 12:1$ , 10 Hz to 3 kHz;  $< 16:1$ , 10 kHz to 3 MHz

##### Video bandwidth

Range (1, 3, 10 sequence): 3 Hz to 300 kHz, HP 70902A; 300 Hz to 3 MHz, HP 70903A

Accuracy (nominal):  $\pm$ 20%

##### Residual FM

Span  $>$  10 MHz x N\*:  $< 25$  kHz p-p in 0.1 s (measurement BW=100 kHz)

Span  $\leq$  10 MHz x N\*: determined from phase-noise sidebands

#### Amplitude

##### Maximum safe input power

ac average continuous: +30 dBm ( $\geq 10$  dB attn)

Pulse power: 100 watts, 10  $\mu$ s pulse ( $\geq 40$  dB attn)

dc: 0 volts

Amplitude temperature drift (nominal):  $\pm 0.05$  dB/ $^{\circ}$ C, accumulated error is eliminated by running internal correction routine.

Resolution bandwidth:  $\pm 0.1$  dB in a 1, 3, 10 sequence

##### IF gain accuracy

Gain	20 to 30 $^{\circ}$ C	0 to 50 $^{\circ}$ C
10 dB	$\pm 0.1$ dB	$\pm 0.1$ dB
20 dB	$\pm 0.1$ dB	$\pm 0.2$ dB
30 dB	$\pm 0.2$ dB	$\pm 0.3$ dB
40 dB	$\pm 0.2$ dB	$\pm 0.5$ dB
50 dB	$\pm 0.3$ dB	$\pm 0.6$ dB
60 dB	$\pm 0.4$ dB	$\pm 0.8$ dB

(HP 71210C only)

##### Input attenuator switching repeatability: $\pm 0.2$ dB

##### Scale fidelity

Log	Bandwidth	Fidelity
corrected (0 to 85 dB)	$\geq 30$ Hz, $\leq 100$ kHz	$\pm 0.5$ dB
	$< 30$ Hz	$\pm 0.7$ dB
	$> 100$ kHz	$\pm 0.7$ dB
	$\leq 1$ MHz	$\pm 0.5$ dB
	$> 1$ MHz	$\pm 0.7$ dB
Incremental fidelity	0.1 dB/dB (uncorrected)	

##### Marker resolution: $\pm 0.03$ dB

##### Display range (10 divisions)

Calibration: 0.01 - 20 dB/div in 0.5% increments, log

0 to 10% of reference level per div, linear

Reference level range: +30 to -140 dBm, log

7.07 V to 22 nV, linear

##### Sweep time

Range (continuous): 10 ms to 1000 s

Accuracy:  $\pm 2\%$

With HP 70700A: 15 ms to 335 s with 800 pt traces, swept range; 80

$\mu$ s to 335 s with 800 pt traces, zero span

##### Trigger: free run, video, external

\*N = harmonic mixing band constant or harmonic multiplier number, M. HP 71100C, N=1.

HP 71200C, 50kHz to 6.2 GHz, N=1; 6.0 to 12.7 GHz, N=2; 12.5 to 19.9 GHz, N=3; 19.7 to 22/26.5 GHz, N=4. HP 71210C, 100 Hz to 6.2 GHz, M=1; 6.0 to 12.8 GHz, M=2; 12.6 to 22 GHz, M=4.

### HP 71100C Specifications

#### Frequency

Frequency range: 100 Hz to 2.9 GHz (dc coupled); 100 kHz to 2.9 GHz (ac coupled); tunable in 1 Hz increments

#### Amplitude

Frequency response (peak variation, 10 dB attn)	Band	Variation
	100 Hz to 2.5 GHz	$\pm 1.0$ dB
	100 Hz to 2.9 GHz	$\pm 1.5$ dB

#### Displayed average noise level

(0 dB attn)	Band	DANL
10 Hz res BW	10 MHz to 2.0 GHz	$< -134$ dBm
	2.0 GHz to 2.9 GHz	$< -131$ dBm

HP 70903A only  
100 kHz res BW for freq  $>$  1 MHz, DANL is 40 dB higher than the above

w/HP 70621A 10 MHz to 2.9 GHz  $-155$  dBm

Gain compression level:  $< 0.5$  dB for signal levels  $\leq -10$  dBm, 0 dB input attn

#### Spurious responses

Spurious responses, mixer level  $\leq -40$  dBm, 10 dB attn:

100 Hz to 10 MHz,  $< -60$  dBc; 10 MHz to 2.9 GHz,  $< -70$  dBc

Second harmonic distortion, mixer level  $\leq -40$  dBm, 10 dB attn:

200 Hz to 20 MHz,  $< -60$  dBc; 20 MHz to 2.9 GHz,  $< -70$  dBc

Third order intermodulation distortion, two signals each

$\leq -30$  dBm at input, 10 dB attn:

100 Hz to 10 MHz,  $< -66$  dBc; 10 MHz to 2.9 GHz,  $< -70$  dBc

Image responses, 10 dB attn:  $\leq -90$  dBc

Residual responses, 0 dB input attn, input terminated:

$< -100$  dBm

### HP 71200C Specifications (unpreselected)

Specifications include option 001 (50 kHz to 26.5 GHz freq range, HP 70906A RF section).

#### Frequency

Frequency range: 50 kHz to 22 GHz (std/opt 002); 50 kHz to 26.5 GHz (opt 001/003); tunable in 1 Hz increments

#### Amplitude

Frequency response (peak variation, 10 dB attn)	Band	Variation
	50 kHz to 2.9 GHz	$\pm 2.3$ dB
	400 kHz to 2.9 GHz	$\pm 1.0$ dB
	2.7 to 6.2 GHz	$\pm 1.0$ dB
	6.0 to 12.7 GHz	$\pm 1.5$ dB
	12.5 to 19.9 GHz	$\pm 2.0$ dB
	19.7 to 22/26.5 GHz	$\pm 2.5$ dB

#### Displayed average noise level

(0 dB attn)	Band	DANL
10 Hz res BW	10 MHz to 2.9 GHz	$< -129$ dBm
	2.7 to 2.9 GHz	$< -132$ dBm
	6.0 to 12.7 GHz	$< -125$ dBm
	12.5 to 19.9 GHz	$< -120$ dBm
	19.7 to 22 GHz	$< -116$ dBm
	22 to 26.5 GHz	$< -115$ dBm

#### Gain compression level: $< 0.5$ dB for signal levels $\leq -10$ dBm, 0 dB input attn

#### Spurious responses

Spurious responses, mixer level  $\leq -40$  dBm, 10 dB attn:

50 kHz to 10 MHz,  $< -60$  dBc; 10 MHz to 22/26.5 GHz,  $< -70$  dBc

Second harmonic distortion, mixer level  $\leq -40$  dBm, 10 dB attn:

100 kHz to 20 MHz,  $< -60$  dBc; 20 MHz to 2.9 GHz,  $< -70$  dBc;

2.7 to 6.2 GHz,  $< -70$  dBc; 6.0 to 12.7 GHz,  $< -60$  dBc; 12.5 to

19.9 GHz,  $< -55$  dBc; 19.7 to 22/26.5 GHz,  $< -50$  dBc

Third order intermodulation distortion, two signals each

$\leq -30$  dBm at input, 10 dB attn:

Center Freq	Intermod products
100 Hz to 10 MHz	$< -66$ dBc
10 MHz to 6.2 GHz	$< -74$ dBc
6.0 to 22/26.5 GHz	$< -76$ dBc

#### HP 71200C Specifications (preselected)

Includes option 002, with HP 70905B RF section and HP 70600A preselector (50 kHz to 22 GHz), and option 003, with HP 70906B RF section and HP 70601A preselector (50 kHz to 26.5 GHz)

#### Frequency

Frequency specifications are the same as for the unpreselected system.

**Frequency span:** range, 0 to 19.3/23.8 GHz in 0.5% increments

#### Amplitude

**Frequency response:** peak variation, 10 dB attn

Band	Bypass/filtered
50 kHz to 2.9 GHz	$\pm 2.6/\pm 2.8$ dB
400 kHz to 2.9 GHz	$\pm 1.3/\pm 1.5$ dB
2.7 to 6.2 GHz	$\pm 1.3/\pm 1.8$ dB
6.0 to 12.7 GHz	$\pm 2.0/\pm 2.3$ dB
12.5 to 19.9 GHz	$\pm 3.2/\pm 3.3$ dB
19.7 to 22/26.5 GHz	$\pm 3.6/\pm 3.7$ dB

**Displayed average noise level, 0 dB attn**

**10 Hz res BW**

Band	Bypass	Filtered	W/HP 70620B/001
10 MHz to 2.9 GHz	$< -127$ dBm	$< -119$ dBm	-140 dBm
2.7 to 6.2 GHz	$< -130$ dBm	$< -118$ dBm	-141 dBm
6.0 to 12.7 GHz	$< -121$ dBm	$< -109$ dBm	-134 dBm
12.5 to 19.9 GHz	$< -115$ dBm	$< -101$ dBm	-125 dBm
19.7 to 22 GHz	$< -111$ dBm	$< -96$ dBm	-119 dBm
22 to 26.5 GHz	$< -109$ dBm	$< -95$ dBm	-115 dBm

**Gain compression level:**  $\leq -5$  dBm (50 kHz to 2.9 GHz), 0 dB input attn;  $\leq 0$  dBm (2.7 to 22/26.5 GHz, 0 dB input attn)

#### Spurious responses

**Second harmonic distortion:**  $\leq -30$  dBm at RF input in bypass and low bands,  $\leq 0$  dBm in high bands, 10 dB attn, filtered 100 kHz to 10 MHz,  $< -66$  dBc; 10 MHz to 2.9 GHz,  $< -76$  dBc; 2.7 to 6.2 GHz,  $< -100$  dBc; 6.0 to 12.7 GHz,  $< -100$  dBc; 12.5 to 19.9 GHz,  $< -90$  dBc; 19.7 to 22/26.5 GHz,  $< -85$  dBc

**Third order intermodulation distortion:** two signals each  $< 0$  dBm filtered, 10 dB attn, filtered 100 Hz to 10 MHz,  $< -58$  dBc; 10 MHz to 2.9 GHz,  $< -66$  dBc; 2.7 to 6.2 GHz,  $< -74$  dBc; 6.0 to 22/26.5 GHz,  $< -76$  dBc

#### Residual responses, 0 dB input attn, input terminated

Range	Bypass/filtered
10 MHz to 2.9 GHz	$< -99/-91$ dBm
2.7 to 6.2 GHz	$< -99/-86$ dBm
6.0 to 12.7 GHz	$< -90/-76$ dBm
12.5 to 19.9 GHz	$< -85/-70$ dBm
19.7 to 22/26.5 GHz	$< -80/-63$ dBm

**Multiple and out-of-band responses:**  $< -60$  dBc, RF input level  $\leq 0$  dBm filtered,  $\geq 10$  dB attn

#### HP 71210C Specifications

#### Frequency

**Frequency range:** 100 Hz to 22 GHz, tunable in 1 Hz increments

#### Amplitude

**Frequency response:** peak variation, 10 dB attn

Band	20° to 30° C	0° to 50° C
100 Hz to 2.9 GHz	$\pm 1.5$ dB	$\pm 2.0$ dB
2.7 to 22 GHz	$\pm 2.0$ dB	$\pm 2.5$ dB

**Referenced to 300 MHz, -10 dBm calibrator; 10 dB atten**

100 Hz to 2.9 GHz	$\pm 2.3$ dB
2.7 to 22 GHz	$\pm 3.3$ dB

**Displayed average noise level:** 0 dB attn, 10 Hz res BW, ref level  $\geq -85$  dBm

Band	DANL	With HP 70620B/001
10 MHz to 2.9 GHz	-139 dBm	-155
2.7 to 12.8 GHz	-136 dBm	-153
12.6 to 22 GHz	-133 dBm	-150

#### Spurious responses

**Second harmonic distortion:** mixer input  $\leq -40$  dBm, 10 dB attn 100 Hz to 20 MHz,  $< -60$  dBc; 20 MHz to 3.5 GHz,  $< -70$  dBc; 3.5 to 22 GHz,  $< -100$  dBc

**Third order intermodulation distortion,** two signals each  $\leq 30$  dBm at input mixer, 10 dB attn: 100 Hz to 10 MHz,  $< -66$  dBc; 10 MHz to 22 GHz,  $< -80$  dBc

**Residual responses:**  $< -100$  dBm, 10 MHz to 22 GHz

**Multiple responses:**  $< -60$  dBc

#### Module input/output characteristics, summary

#### HP 70900B LO Section

**300 MHz calibrator output BNC, 50 ohm, front panel:**  $-10$  dBm  $\pm 0.3$  dB

**Ext freq ref input:** SMB, rear panel, 50 ohm (nominal), 100 MHz  
**HP-IB functions:** SH1, AH1, T6, L4, SR1, RL1, DC1, PP0, DT1, E2, C1

#### HP 70902A IF Section

**Auxiliary video output:** BNC, 0 to 1 V, 1 k-ohm (nominal), front panel

**3 MHz IF output (linear):** BNC, 50 ohm, 1.5:1 VSWR (nominal), front panel

#### HP 70903A IF Section

**Auxiliary video output:** BNC, 0 to 1 V, 100 ohm (nominal), front panel

#### HP 70904A RF Section

**RF input (100 Hz to 2.9 GHz):** type N, 50 ohm (nominal), front panel  
**LO emissions (10 dB attn)**

**VSWR ( $\geq 10$  dB attn):**  $< 1.3:1$  (nominal):

**VSWR (0 dB attn):**  $< 2.9:1$  (nominal)

**Probe power output:** +15 V, -12 V and ground, 150 mA max, front panel

#### HP 70905A/B, 70906A/B RF Sections

**RF input:** type N/APC-3.5, 50 ohm (nominal), front panel

**VSWR ( $\geq 10$  dB attn) (nominal):**

0 to 12.7 GHz,  $< 1.7:1$ ; 12.5 to 18.0 GHz,  $< 2.0:1$ ; 18.0 to 22/26.5 GHz,  $< 2.5:1$

#### HP 70600A/70601A preselector

**RF input:** type N/APC-3.5, 50 ohm (nominal)

**VSWR ( $\geq 10$  dB attn) (nominal):**

0 to 12.7 GHz,  $< 1.9:1$ ; 12.5 to 22/26.5 GHz,  $< 2.2:1$

**RF output:** SMA, 50 ohm (nominal), front panel

#### HP 70908A RF section

**RF input:** type N, 50 ohm (nominal), front panel

**VSWR ( $\geq 10$  dB attn) (nominal):**

0 to 12.7 GHz,  $< 1.9:1$ ; 12.8 to 18.0 GHz,  $< 2.3:1$ ; 18.0 to 22.0 GHz,  $< 2.5:1$

#### HP 70004A Display

**R, G, B color outputs (horiz sync on green):** RCA phono, 75 ohm (nominal), rear panel, 1 V peak-peak +10%

**Horizontal sweep rate:** 25.5 kHz

**Refresh rate:** 60 Hz, 25 MHz bandwidth

**HP-HIL interface:** front panel

**HP-IB functions:** SH1, AH1, T5, L3, SR1, RL1, PP0, DC, DT0, E1, C27

#### General Specifications

#### Environmental

**Temperature:** 0° to 55° C operational, -40° to +75° C storage

**EMC:** conducted and radiated interference is in compliance with CISPR Pub 11, FTZ 526/1979, and MIL-STD 461B, RE02/part 7

#### Power requirements

#### HP 70001A mainframe

**ac main:** 100, 120, 220, and 240 Vac (+10%)

**Frequency:** 47 to 66 Hz (400 Hz with opt 400, 401—100 and 120 Vac only)

**Max power:** 200 watts

#### HP 70004A display

**ac main:** 100, 120, 220, and 240 Vac (+10%)

**Frequency:** 47 to 66 Hz and 400 Hz

**Max power:** 260 watts

**Modules:** all power requirements supplied by mainframe, HP 70001A or 70004A

#### Size

**HP 70001A mainframe:** 177.0 H x 425.4 W x 526.0 mm D (6.97" x 16.75" x 20.7")

**HP 70004A display:** 222.0 H x 425.4 W x 526.0 mm D (8.74" x 16.75" x 20.7")

# SIGNAL ANALYZERS

## Modular Measurement System (cont'd)

### HP 70000 Series

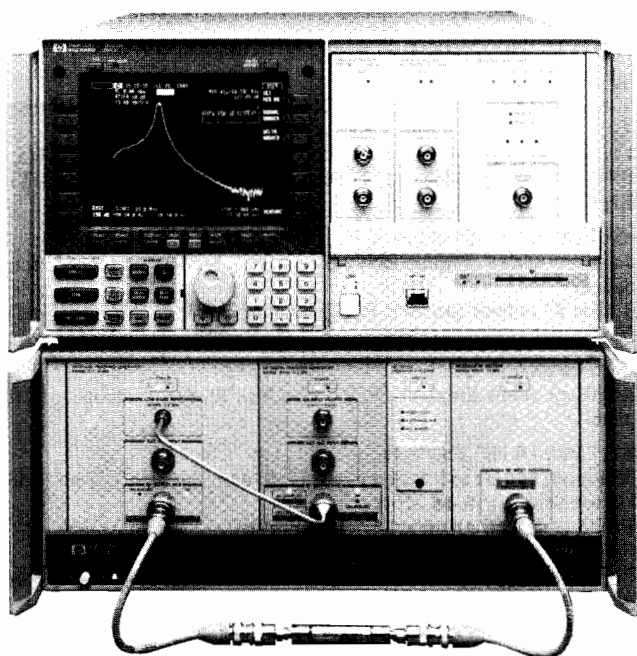

#### Communications Measurements

The HP 70000 series spectrum analyzers have 117 Hz/GHz frequency accuracy, which allows you to measure closely spaced communication channels. Low phase noise of  $-108$  dBc/Hz (10 kHz offset) allows close-in testing of low-level spurious signals in transmitters. You can convert from an RF to a microwave system by simply replacing the RF front-end module. And to extend to millimeter frequencies, add the HP 70907B external mixer interface module and HP 11970 series harmonic or HP 11974 series preselected millimeter mixers. (See page 187 for more details.)

#### Digital Cellular Radio-GSM

The capabilities and features of the modular spectrum analyzers enable them to excel in such applications as the testing and monitoring of satellites and the design of analog and digital radios. The HP 71150C RF and 71250C microwave GSM transmitter test systems, based on the HP 70000 series analyzers, are designed to meet the exacting specifications of the new Pan European Digital Cellular Radio System (GSM). Both systems include the new HP 11836B GSM personality.

#### Radar Measurements

A digital persistence feature of the HP 70000 spectrum analyzer display simulates the characteristics of an analog display. This allows you to view, measure, and record multiple signal patterns, such as double-pulse output from a radar transmitter. In zero span, the analyzer becomes a fixed tuned receiver so that you can demodulate the signal and view the pulses. Add an HP 70700A digitizer module to decrease minimum sweep time to 80  $\mu$ s in the time domain (zero span). You can then view fast rise time pulses and retain the benefits of a digital display. The digitizer provides fast sampling of pulses and, for infrequent or erratic pulses, a Random Event Capture feature allows you to measure the time between randomly occurring pulses while it gives you detailed information about the pulse shape. Detection modes ensure that the amplitudes and times of occurrence of narrow radar pulses over long periods of observation are not missed.

#### Component Test

For scalar-analysis measurements, the HP 70300A tracking generator covers 20 Hz to 2.9 GHz with a 124-dB dynamic range. The HP 70301A covers 2.7 GHz to 18 GHz with 130-dB dynamic range. Together the tracking generators provide fast, continuous sweeps from 10 MHz to 18 GHz. Even the most demanding, filter-rejection measurements are now possible. A downloadable program for scalar-network-analysis measurements gives the spectrum analyzer a user interface for making transmission or reflection measurements using open-short and through normalization. You can enter limit lines for upper and lower boundaries, and a pass/fail indicator lets you know the results of your tests.

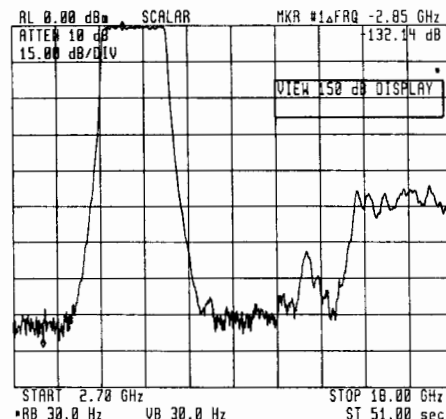

Measure filter rejection with 130 dB dynamic range at 18 GHz

#### Tracking Generator Specifications

	HP 70300A (w/HP 71100C)	HP 70301A (w/HP 71210C)
<b>Tracking generator range</b>	100 kHz to 2.9 GHz	10 MHz to 18 GHz
<b>Dynamic range @ 1 GHz</b>	> 124 dB	> 130 dB
<b>@ 2.7 GHz</b>	> 121 dB	> 130 dB
<b>@ 18 GHz</b>		
<b>Displayed average noise level</b>		
<b>@ 1 GHz</b>	-134 dBm	
<b>@ 2 GHz</b>		-138 dBm
<b>@ 18 GHz</b>		-133 dBm
<b>Output level:</b> -10 to -91 dBm (0.01 dB resolution) with 70300A; 0 dBm (20-30°C) to -66 dBm (0.01 dB resolution) with 70301A		
<b>Power sweep:</b> 0 to -10 dBm		
<b>Dynamic accuracy (normalized)</b>		
<b>90 dB range:</b> $\pm 0.5$ dB, $\pm 0.1$ dB/dB, incremental		

#### Highest spectrum analyzer performance

When your measurement situation demands top performance, HP modular spectrum analyzers provide the solutions. You can select front-end modules for RF, microwave, millimeter, and lightwave capabilities. For the highest performance, the HP 71210C spectrum analyzer has a dynamically tracking preselector that keeps the system peaked under all environmental conditions. Fundamental mixing provides sensitivity of  $-139$  dBm at 1 GHz and  $-133$  dBm at 22 GHz for fast, accurate measurement of spurious response. Even better sensitivity can be obtained by adding the HP 70620A preamplifier. Sensitivity at 22 GHz reaches  $-154$  dBm, so you can measure extremely low-level signals. Flatness remains superb throughout the frequency range.



### Ordering information

<b>HP 71100C</b> RF spectrum analyzer, 100 Hz to 2.9 GHz	<b>Price</b> \$46,450
System components	
HP 70001A mainframe	
HP 70004A color display	
HP 70900B local oscillator	
HP 70310A precision frequency reference	
HP 70902A IF section	
HP 70904A RF section	
<b>HP 71200C</b> microwave spectrum analyzer, 100 Hz to 22 or 26.6 GHz	\$51,500
System components	
HP 70001A mainframe	
HP 70004A color display	
HP 70900B local oscillator	
HP 70310A precision frequency reference	
HP 70902A IF section	
Standard	
HP 70905A RF section	
<b>Opt 001</b> HP 70906A RF section	\$1,890
<b>Opt 002</b> HP 70905B RF section, HP 70600A preselector	\$8,250
<b>Opt 003</b> HP 70906B RF section	\$14,000
HP 70601A preselector	
<b>HP 71210C</b> microwave spectrum analyzer, 100 Hz to 22 GHz, fundamentally mixed	\$80,600
System components	
HP 70001A power meter	
HP 70004A color display	
HP 70900A local oscillator	
HP 70310A precision frequency reference	
HP 70902A IF section	
HP 70903A IF section	
HP 70908A RF section	
<b>Options for the HP 71100C, 71200C, 71210C</b>	
<b>Opt 006</b> delete HP 70902A narrowband IF section	-\$4,990
<b>Opt 110</b> delete HP 70301A precision frequency reference	-\$2,550
<b>Opt 121</b> add distribution amplifier to the HP 70310A	+\$1,600
<b>Opt 122</b> delete ovenized oscillator in HP 70310A, maintain external reference capability	-\$2,500
<b>Opt 201</b> delete HP 70001A mainframe	-\$3,580
<b>Opt 205</b> substitute the HP 70205A for the HP 70004A	-\$4,250
<b>Opt 206</b> substitute the HP 70206A for the HP 70004A	-\$1,640
<b>Opt 400</b> add 400 Hz power line frequency operation to HP 70001A	+\$765
<b>Opt 401</b> add 400 Hz power line frequency operation to HP 70001A and 70206A	+\$1,885
<b>Option for the HP 71100C, 71210C</b>	
<b>Opt 1BH</b> general export version	\$0
<b>HP 71150C</b> GSM transmitter test system, 100 Hz to 2.9 GHz	\$94,055
Systems components	
HP 70001A mainframe	
HP 70004A color display	
HP 70310A option 002 option H25 precision frequency reference	
HP 70700A digitizer (2 each)	
HP 70900B option 512 LO	
HP 70902A IF section	
HP 70903A IF section	
HP 70904A option H25 RF section	
HP 70912B downconverter	
HP 11836B GSM personality	
HP 8657A option 001 signal generator	

**HP 71250C** GSM transmitter test system, 100 kHz to 22 GHz \$123,960  
 Contains the same system components as the HP 71150C with the substitution of the HP 70908A option H25 section for the HP 70904A option H25.

### Options for the HP 71150C and 71250C GSM transmitter test systems

<b>Opt 012</b> 70100A power meter and 8482A sensor	\$3,610
<b>Opt 013</b> 70621A option H50 preamp/switch	\$7,250
<b>Opt 015</b> HP 11836A upgrade	-\$20,560
<b>Opt 020</b> add HP 70320A option 001; delete HP 8657A option 001	\$9,000
<b>Opt 057</b> delete HP 8657A option 001	-\$9,500

### Basic Components

<b>HP 70001A</b> mainframe, 8 module	\$6,750
<b>HP 70004A</b> color display/mainframe, 4 module slots	\$9,975
<b>HP 70205A</b> graphics display	\$5,730
<b>HP 70206A</b> system graphics display	\$8,325
<b>HP 70310A</b> precision frequency reference	\$5,090
<b>HP 70900B</b> local oscillator	\$19,180
<b>HP 70902A</b> IF section, RBW 10 Hz to 300 kHz	\$4,990
<b>HP 70903A</b> IF section, RBW 100 kHz to 3 MHz	\$3,895
<b>HP 70904A</b> RF section, 100 Hz to 2.9 GHz	\$9,000
<b>HP 70905A</b> RF section, 50 kHz to 22 GHz	\$11,150
<b>HP 70905B</b> RF section, 50 kHz to 22 GHz, no attenuator, use only with preselector	\$10,160
<b>HP 70906A</b> RF section, 50 kHz to 26.6 GHz	\$13,040
<b>HP 70906B</b> RF section, 50 kHz to 26.5 GHz, no attenuator, use only with preselector	\$12,020
<b>HP 70907B</b> external mixer interface	\$9,500
<b>HP 70908A</b> RF section, 100 Hz to 22 GHz, fundamentally mixed	\$37,440

### Other modules and accessories

<b>HP 70100A</b> power meter, 100 kHz to 50 GHz	\$2,960
<b>HP 70138A</b> vector voltmeter, 100 kHz to 1 GHz	\$5,930
<b>Opt 050</b> 300 kHz to 2 GHz, 50 ohm input module replaces high impedance input module	\$0
<b>HP 70300A</b> RF tracking generator, 20 Hz to 2.9 GHz	\$12,225
<b>HP 70301A</b> microwave tracking generator, 10 MHz to 18 GHz	\$25,575
<b>HP 70320A</b> synthesized signal generator, 252 GHz to 1030 MHz (2060 MHz with opt 002)	\$17,200
<b>HP 70322A</b> synthesized signal generator, 100 kHz to 4.2 GHz	\$36,000
<b>HP 70325A</b> agile signal generator, 252 kHz to 1030 MHz (2060 MHz with opt 002)	\$32,900
<b>HP 70591A</b> 1/8 width module part kit	\$780
<b>HP 70592A</b> 2/8 width module part kit	\$830
<b>HP 70593A</b> 3/8 width module part kit	\$1,460
<b>HP 70594A</b> 4/8 width module part kit	\$2,550
<b>HP 70595A</b> module development design guides	\$610
<b>HP 70596A</b> module communication design guides	\$610
<b>HP 70597A</b> MSIB module interface software	\$0
<b>Opt 100</b> source code and documentation	+\$950
<b>Opt 200</b> design consulting support	+\$8,000
<b>Opt 001</b> prototype CPU board	+\$2,000
<b>Opt 002</b> MSIB extender module	+\$700
<b>Opt 910</b> extra manuals	+\$100
<b>HP 70600A</b> preselector, 2.7 GHz to 22 GHz	\$10,790
<b>HP 70601A</b> preselector, 2.7 GHz to 26.5 GHz	\$13,140
<b>HP 70620B</b> preamplifier, 1-26.5 GHz	\$8,000
<b>Opt 001</b> 100 kHz to 26.5 GHz	\$4,500
<b>HP 70621A</b> preamplifier, 100 kHz to 2.9 GHz	\$4,900
<b>HP 70700A</b> digitizer	\$7,980

Option 098 controller board kit and option 099 firmware upgrade kit are available free on many accessory modules to spectrum analyzer systems. Consult with your sales representative at the time of order to see if needed.

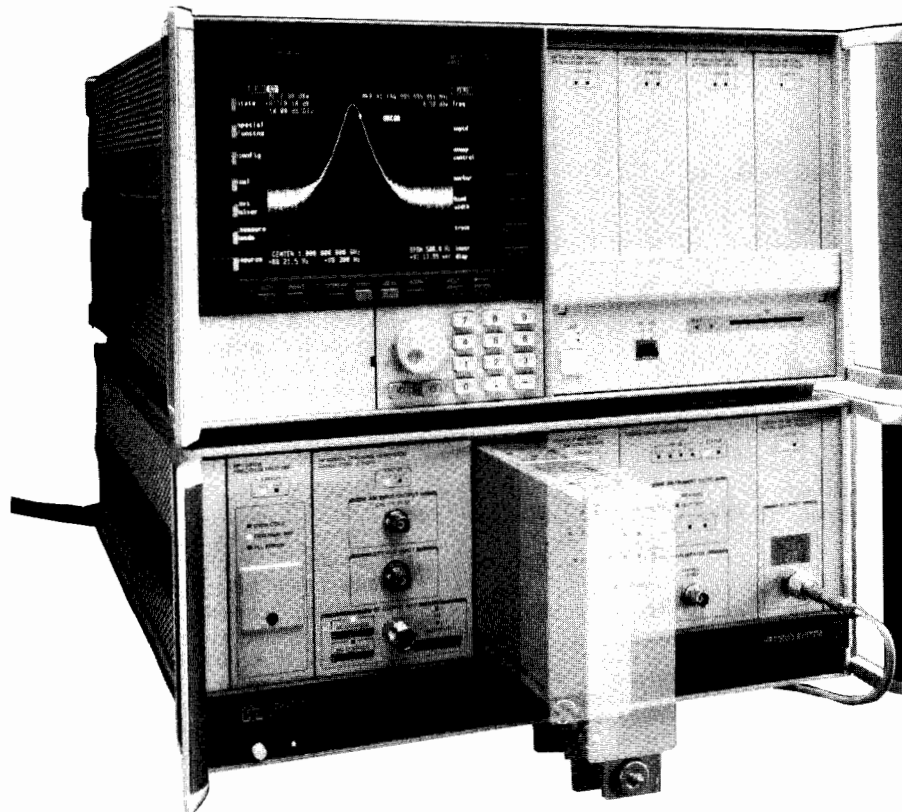

HP 70611A

### HP 70611A Attenuator/Switch Driver

HP now offers designers of modular measurement system products a switch controller in the MMS format. The HP 70611A attenuator/switch driver is ideally suited to drive test-station interface modules that have been designed to include HP 84940A driver cards.

When mated with HP 84940A driver cards, the HP 70611A can control up to 248 (total) RF and microwave devices through either the modular system interface bus (MSIB) or the HP-IB (see Figure 1). One HP 84940A driver card, which has the capacity to drive up to 31 electromagnetic switches or attenuator switch sections, may be incorporated directly within the HP 70611A. Or, up to eight of the driver cards may be located remotely at the end user's test station.

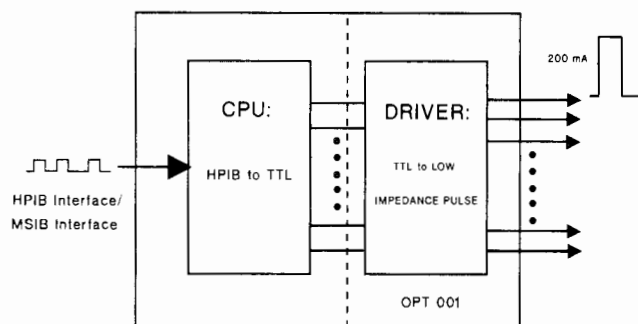

Figure 1.

In addition to providing ATE designers with an expandable and convenient remote interface to their test stations, the HP 70611A attenuator/switch driver features a manual interface that can be customized by the user. This manual interface, which is realized through any MMS display, allows the end user to select pulse widths, to enable or disable switch settings, to create custom menus with labels, and to automatically select pre-defined switch states.

### Accessories

HP offers a full line of switches and attenuators for use with the HP 70611A attenuator/switch driver. Custom switching solutions are also available that incorporate driver controller and microwave hardware into custom rack mounted boxes or MMS modules. For more information, contact your local HP sales office listed on page 737.

### Specifications

**Size:** 1/8-width MMS module

**Switching speed:** Dependent on switch pulse selected (P) and whether sensing delay (D) is enabled. For N switches switched, maximum switching time is  $[INT(N/4) + 1] * [P+D]$ .

**Drive capacity:** 248 devices via interconnection with eight HP 84940A driver cards. Each HP 84940A is capable of driving 31 devices. HP 70611A option 001 includes a single integrated HP 84940A and can drive 31 devices directly.

**EMI:** within limits specified by MIL-STD 461B

**Environmental performance:** Meets requirements of MMS hardware. See Product Note 70000-1, HP 70000 System Design System Overview, for details.

### Ordering Information

HP 70611A attenuator/switch driver

Opt 001 integrates HP 84940A driver card

HP 84940A driver card

### Price

\$3,600

\$4,600

\$1,000

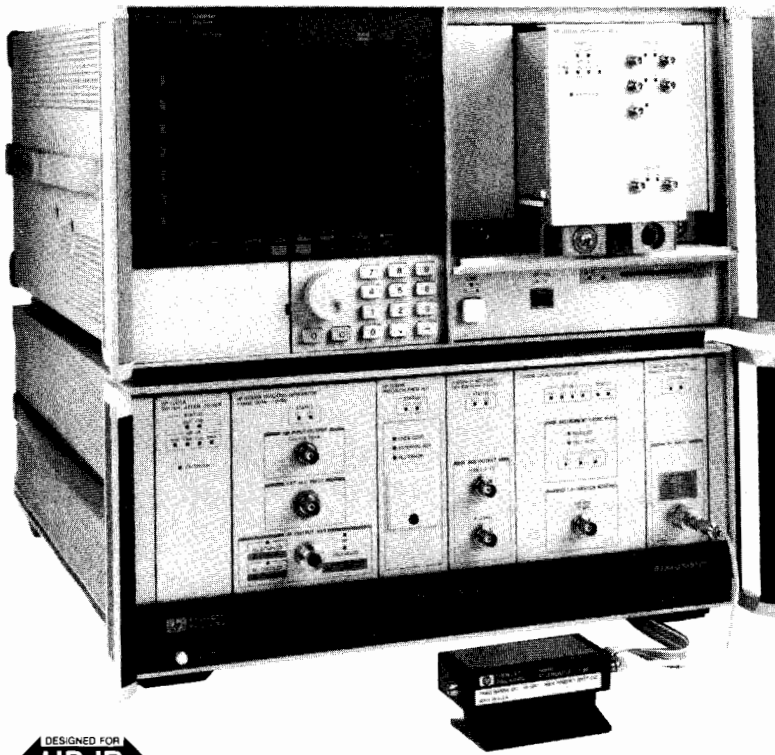

HP 70612A



### HP 70612 and 70613 Series Switch Matrixes

This new family of standard interface modules gives the designer of modular measurement system (MMS) products an off-the-shelf solution to problems of interconnection. The HP 70612 and 70613 are 1x6 and 2x5 common highway switch matrixes (see Figure 1) available in different frequency bands covering DC to 26.5 GHz. These matrixes come in 1/4-width MMS modules.

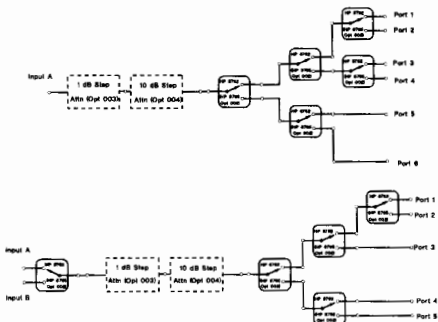

Figure 1

In addition to routing signals between sources and devices under test, the HP 70612 and 70613 feature attenuator options for adjusting signal strengths from 0 to 110 dB in 1 dB steps. Input ports terminated in 50 ohms are standard. Front-panel indicators, which alert the user to current switch status, and front-panel 3.5 mm connectors also are standard. Rear-panel inputs are available.

These switch matrixes can be controlled remotely via the modular system interface bus (MSIB) or the HP-IB. A manual interface that allows users to specify alphanumeric labels for multiple switch states and to recall these pre-defined states using the labels is created using

any MMS display. Up to 217 additional devices can be controlled remotely by an HP 70612 or 70613 using HP 84940A driver cards installed in other interface modules at remote locations. Option 011 for the HP 70612 and 70613 deletes the MSIB/HP-IB interface card (CPU). The resulting module contains only microwave hardware and an HP 84940A driver card. The option 011 module is designed to be controlled by an HP 70611A.

Along with the standard interface boxes, HP offers the ATE test-set designer custom rack-mount and MMS-compatible interface modules containing hardware such as switches, attenuators, detectors, couplers, indicators, and amplifiers. For more information on HP's custom matrix capabilities and for complete specifications on the HP 70612 and 70613 series, contact your local HP sales office listed on page 737.

### Ordering information

	Price
HP 70612A 1x6 matrix, DC to 6.5 GHz	\$8,400
HP 70612C 1x6 matrix, DC to 26.5 GHz	\$9,400
HP 70613A 2x5 matrix, DC to 6.5 GHz	\$8,400
HP 70613C 2x5 matrix, DC to 26.5 GHz	\$9,400
Opt 002 delete switch terminations	-\$1,000
Opt 003 add 1 dB, 6.5 GHz step attenuation (A models)	+\$825
Opt 003 add 1 dB, 26.5 GHz step attenuation (C models)	+\$1,800
Opt 004 add 10 dB, 6.5 GHz step attenuation (A models)	+\$825
Opt 004 add 10 dB, 26.5 GHz step attenuation (C models)	+\$1,300
Opt 005 add rear panel inputs	+\$250
Opt 011 delete CPU card	-\$1,200

# SIGNAL ANALYZERS

## EMC Measurement Systems

### HP 84000 Series

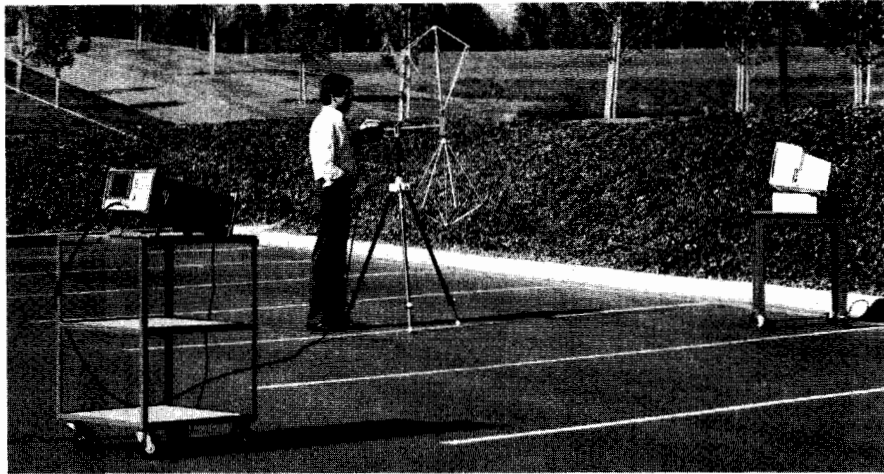

#### HP 84110A EMC Pre-production Evaluation System

#### HP 84000 Series EMC Measurement Systems

The best way to eliminate problems of electromagnetic compatibility is to attack them at all stages of product development. For this you need the right test equipment. HP now offers a full line of EMC measurement systems to help you with all aspects of this task--from testing of initial designs through formal compliance measurements. Whether you need simple EMC design tools or a fully automated EMI compliance test system, you will find a solution to improve your productivity. All HP 84000 series EMC measurement systems reflect HP's extensive knowledge and experience of EMC testing and are backed by our proven quality and worldwide support.

#### HP 84100A EMC Design Development System

The sooner you consider the EMC performance of a new product design, the fewer EMC problems you will encounter later in the product-development cycle. The HP 84100A system gives you the right tools for quickly locating EMC problems at the breadboard and prototype levels. The heart of the system is a portable spectrum analyzer with a 9-kHz to 1.8-GHz frequency range. The analyzer has a built-in tracking generator for making quick immunity and shielding-effectiveness measurements. An EMC measurement 'personality' installed in the system makes EMC measurements easy for beginners and supplies advanced capabilities for experienced troubleshooters. Two calibrated magnetic-field probes are included for locating emission hot spots on printed circuit boards, cables, and power supplies. And the system has an HP-IB interface for one-button output to printers and plotters.

To further enhance your design-development skills, HP offers a two-day course on 'Designing for EMC.' See page 200 for details.

#### HP 84110A EMC Pre-production Evaluation System

If you send your products to consultants or independent test facilities for final compliance measurements, pre-compliance testing can save you time and money at final compliance test time. The HP 84110A takes the mystery out of finding the right equipment for this job. The system includes an easy-to-use portable spectrum analyzer with built-in quasi-peak detection to measure device emissions. The analyzer is enhanced with EMC diagnostic capabilities as well as capabilities for making conducted and radiated measurements. Accessories include a line impedance stabilization network (LISN), a transient limiter, two calibrated magnetic-field probes, two antennas, and a tripod. An HP-IB interface allows one-button output to printers and plotters.

While not intended for formal compliance testing, the HP 84110A offers impressive pre-test capabilities for a fraction of the price of a full EMC compliance test system.

#### HP 84120A EMI Pre-compliance Measurement System

This pre-compliance measurement system has all the capabilities of the HP 84110A plus two more. First, the HP 84120A adds automation software that runs on a variety of computers available for the

system. This allows you to collect data, correct for antenna factors and cable losses, analyze data and store it on disk, and output data and reports to printers and plotters--all automatically.

Second, the pre-compliance measurement system can be upgraded to a complete final compliance test system. The HP 84120A comes with a 10-kHz to 1.5-GHz spectrum analyzer and a quasi-peak adapter. These can be combined with our RF preselector to make an EMI test system that meets all CISPR Publication 16\* EMI receiver requirements.

In addition to measurement hardware and software, the HP 84120A system includes antennas for commercial radiated EMI measurements and a LISN for conducted EMI measurements. A low noise preamplifier (9 kHz to 1.3 GHz) provides additional sensitivity, and a portable antenna tower and turntable are also included.

#### HP 84130A EMI Commercial Compliance Measurement System

This test system has the accuracy and capabilities you need to be confident of your EMI compliance measurement results. Built around the HP 8574B EMI receiver, it meets the requirements of CISPR Publication 16\*. This high performance system offers outstanding capabilities not available in conventional EMI receivers.

Frequency range of the HP 84130A is 9 kHz to 1.5 GHz. The EMI receiver has full RF preselection; peak, quasi-peak, and average detection; and specialized bandwidths that meet or exceed CISPR specifications. Two powerful software programs automate the system for conducted-emission and radiated-emission measurements made inside shielded enclosures and radiated-emission measurements made at open-area test sites. The automated system tests to specifications of the FCC, VDE, FTZ, VCCI, DOC, and other international regulatory agencies.

Accessories include antennas, automatic antenna-positioning mast, automatic turntable, LISN, transient limiter, coaxial cables and adapters, HP-IB cables, and power cords. An optional site-attenuation package gives you the hardware needed to characterize an outdoor range or semi-anechoic chamber.

Ordering Information	Price
HP 84100A EMC design development system	\$22,325
Opt 103 quasi-peak detection and AM/FM demodulation	+\$1,700
HP 84110A EMC pre-production evaluation system	\$26,945
Opt 010 tracking generator	+\$3,600
HP 84120A commercial EMI pre-compliance measurement system	\$58,175
HP 84130A commercial EMI compliance measurement system	\$119,500
Opt 657 site-attenuation kit	+\$16,180

\*CISPR Publication 16 is the Comite International Special des Perturbations Radioelectrique specification for radio interference measuring apparatus and measurement methods.

# SIGNAL ANALYZERS

## EMI Receivers, 9 kHz to 1.5 GHz

HP 8573B, 8574B

197

- Built to CISPR Publication 16\* recommendations
- Automatic or manual FCC, FTZ, VCCI, CSA compliance testing
- Diagnostic EMI measurements

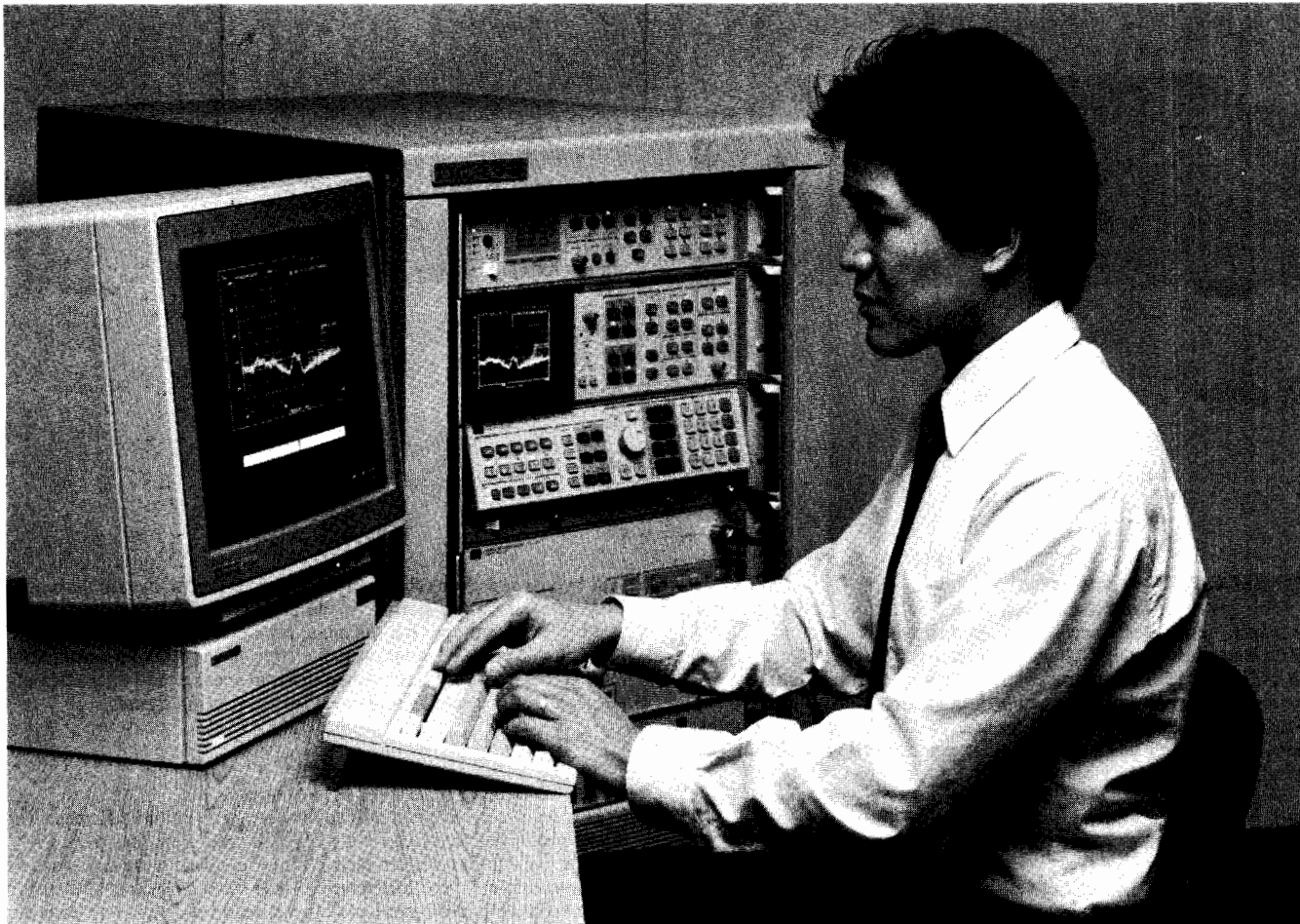

HP 8573B



The HP 85879A radiated emissions measurement software simplifies radiated emission measurements made in the presence of ambient signals. Results are accurate, repeatable, and fully documented.

### HP 8573B and 8574B EMI Receivers

These receivers have everything you need to make fast, accurate EMI compliance measurements in accordance with FCC, FTZ, VCCI, and CSA regulations. Each includes an HP 85860A quasi-peak adapter, an HP 85865A RF preselector, and an HP 8567A or 8568B spectrum analyzer. For easy startup, each receiver is completely configured and verified at the factory, and it is shipped to you in a system cabinet.

In addition to final compliance measurements, the HP 8573B and 8574B EMI receivers are excellent for diagnostics. You can quickly identify problem areas using the swept frequency features of the spectrum analyzer in the system.

### Automated EMI Measurements

Optional HP 85869A EMI measurement software turns your receiver into a fast, easy-to-operate, automatic test system. The software automates conducted-emission and radiated-emission measurements made inside chambers. Test setups for common compliance measurements, typical antenna factors, and many test limits are included. You can easily modify any of these parameters to customize tests for specific applications.

### Accessories and Optional Configurations

Complete your EMI receiver system by choosing from a full line of accessories for conducted and radiated measurements: line impedance stabilization networks (LISN), antennas, positioning equipment, and transducers. See page 201. Or, order the HP 84130A EMI measurement system for commercial compliance. It offers a complete measurement setup that includes all accessories and transducers required for commercial EMI compliance tests. See page 196.

### Ordering Information

	Price
HP 8573B EMI receiver (with HP 8567A spectrum analyzer)	\$60,495
HP 8574B EMI receiver (with HP 8568B spectrum analyzer)	\$68,652
Opt 630 HP 85869A EMI measurement software 3.5-inch disk	+\$7,000
HP 85879A radiated emissions measurement software	\$8,000
HP 85874A combined EMI software	\$11,000
HP 85874B combined EMI software	\$15,000

\*CISPR Publication 16 is the Comité International Spécial des Perturbations Radioélectrique specification for radio interference measuring apparatus and measurement methods.

# SIGNAL ANALYZERS

## RF Preselector, 20 Hz to 2 GHz/Quasi-Peak Adapter

HP 85685A, 85650A

- Automatic filter tracking
- Input overload protection
- Low system noise

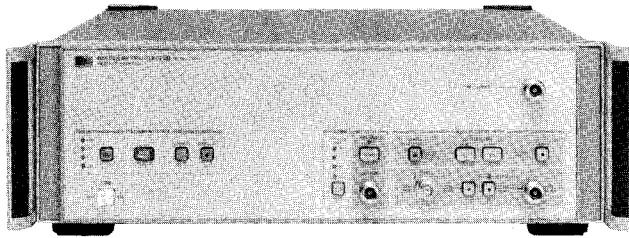

HP 85685A

- Quasi-peak detection
- CISPR-specified bandwidths
- Bypass for regular spectrum analyzer operation

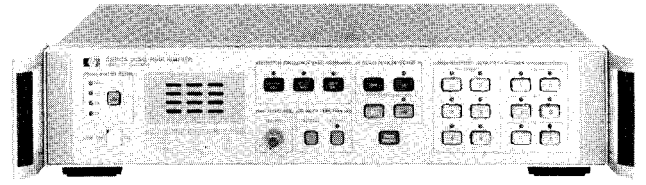

HP 85650A



### HP 85685A RF Preselector

This instrument turns an HP 8566B, 8567A, or 8568B Spectrum Analyzer into a test receiver for specialized applications. The RF preselector has tracking filters and preamplifiers covering the 20 Hz to 2 GHz range. This improves spectrum analyzer measurement sensitivity while providing overload protection from out-of-band signals. The resulting test receiver system, operated in the presence of high-level interference, has a measurement range 30 dB greater than that of a spectrum analyzer alone.

Together the preselector and spectrum analyzer measure signals within the filter passband of the preselector and reject out-of-band interference by 40 dB. This enables low-level signals to be monitored in the presence of high-level ambients. The preselector decreases input overload from out-of-band signals, thereby increasing the range for measuring low-level signals. Fast, wideband measurements mean a reduction in measurement time.

Combining the HP 85685A RF preselector with an HP 8566B, 8567A, or 8568B spectrum Analyzer and the HP 85650A quasi-peak adapter gives you an EMI receiver that meets the recommendations of CISPR Publication 16\*.

The RF preselector adds the measurement sensitivity and overload protection needed for FCC, VDE, and VCCI radiated emission testing. For commercial and MIL-STD conducted EMI tests, the low-frequency input withstands large impulses and line impedance stabilization network (LISN) transients. A built-in calibrator ensures  $\pm 2.0$  dB absolute-amplitude accuracy as required by the regulatory agencies and a convenient linearity check tests for system overload.

Operating the test receiver is easy. Use only the spectrum analyzer controls—the RF preselector automatically adjusts input-filter tracking, and the spectrum analyzer reports preselector operating conditions on the CRT. The receiver system is fully HP-IB programmable, and the HP 85685A comes equipped with the hardware needed to connect it to any compatible spectrum analyzer.

### HP 85650A Quasi-peak Adapter

The HP 85650A quasi-peak adapter works with the HP 8566B, 8567A, and 8568B spectrum analyzers and with the 85685A RF preselector to complete an EMI test receiver system. The quasi-peak adapter adds the special bandwidth filters and quasi-peak detection capability specified in CISPR Publication 16\*. These bandwidth filters (200 Hz, 9 kHz, and 120 kHz) have 6 dB resolution and may be selected using either peak or quasi-peak detection.

A bypass switch enables the spectrum analyzer to bypass the quasi-peak adapter, and a normal mode allows use of the three CISPR bandwidths whether or not the quasi-peak detector is being used. The HP 85650A is fully programmable over the HP-IB for automated measurements, and it has both an internal speaker and an audio output jack (for external headphones) for monitoring signals.

### HP 85867A EMI Receiver Functions

This set of softkey programs simplifies commercial EMI measurements performed manually using HP EMI receivers (see page 197). An external computer is not needed after the softkeys are downloaded into spectrum analyzer non-volatile RAM. You can select a CISPR\* band, make automatic quasi-peak measurements at up to six discrete frequencies, and directly print or plot measurement data using front-panel softkeys.

Features of the EMI Receiver Functions include a quasi-peak softkey that automatically chooses resolution bandwidths, video bandwidths, CISPR bandwidths, and sweep times for fast, accurate quasi-peak measurements. Up to six quasi-peak markers and numeric values can be displayed at the same time. This lets you simultaneously view a wide frequency span and the quasi-peak values of up to six signals. A numeric keypad overlay for the spectrum analyzer is included to help you select the right softkey, and a help function gives the purpose of each softkey. Options are available for factory installation of this product.

### Ordering Information

	Price
HP 85685A RF preselector	\$22,255
Option 010, rackmount slide kit	+ \$395
Option 908, rack flange kit without handles	+ \$33
Option 910, extra manual	+ \$51
Option 913, rack flange kit with handles	+ \$36
HP 85650A quasi-peak adapter	\$5,585
Option 908, rack flange kit without handles	+ \$26
Option 910, extra manual	+ \$10
Option 913, rack flange kit with handles	+ \$31
HP 85867A EMI receiver functions	
Option 630 3 1/2-inch media	\$300
Option 655 5 1/2-inch media	\$300

\*CISPR Publication 16 is the Comite International Special des Perturbations Radioelectrique specification for radio interference measuring apparatus and measurement methods.

- EMC design evaluation tools
- Automated EMI compliance testing

- Test libraries for major regulatory agencies
- Complete, customized test reports

#### HP 85712B EMC Measurement Personality Card

This memory card customizes the HP 8590B, 8591A, 8592B, and 8593A portable spectrum analyzers for electromagnetic compatibility testing. Evaluation capabilities include limit lines, antenna-factor correction, quasi-peak measurements\*, average measurements, narrowband and broadband discrimination, EMC diagnostic keys, and EMC pre-compliance measurement keys. The EMC-measurement-enhanced analyzer works with the HP 11945A set of close-field probes to quickly locate EMI hot spots in your product, allowing you to read magnetic-field strength in dB $\mu$ A/m at the probe tip. (For more information on the HP 8590 series portable spectrum analyzers, see page 173.)

#### HP 85869A EMI Measurement Software

The EMI measurement software is a general-purpose program for making radiated and conducted emission measurements automatically according to commercial and military regulations. The program is designed for use with the HP 8573B and 8574B EMI receivers. A friendly menu structure leads you through an EMI measurement from initial setup to the final plotting of the test results. The HP 85869A has an easy setup procedure, so you are ready to run even if you have never programmed before.

#### Automate MIL-STD and Commercial EMI Measurements

The HP 85869A EMI measurement software automates military and commercial EMI measurements made in shielded enclosures. The program takes advantage of the ability of the spectrum analyzer to quickly measure wide frequency spans and locate hot spots using peak detection. For commercial measurements, quasi-peak data need be taken only at these hot spots. Save time and effort in your MIL-STD measurements by letting the software automatically discriminate between narrowband and broadband signals.

#### Design Your Own Tests

Design your own tests or choose from the examples given in the software. These examples reside in the test library and include MIL-STD, FCC, VDE, and FTZ emission tests. Transducer factors, test limits, and receiver parameters are easily changed and stored. Once you have designed a test, it is stored away and can be executed repeatedly at the push of a key.

#### HP 85879A Radiated Emissions Measurement Software

Automate your commercial EMI compliance testing with the radiated emissions measurement software. This program, designed for use with the HP 8573B and 8574B EMI receivers, simplifies radiated emission measurements made in the presence of ambient signals. Results are accurate, repeatable, and fully documented.

#### Separate Ambient Signals From EUT Emissions

The software generates a list of signal frequencies and amplitudes (along with antenna positions). This enables you to quickly identify and catalog ambient signals in the test environment. A Pre-compliance Scan feature helps you locate EUT emissions by scanning a selected frequency band and identifying potential emissions. Positioning equipment such as the antenna tower and EUT turntable are adjusted automatically by the software to maximize the signals. The software then creates a list of the suspect signals that require testing for final EMI compliance.

#### Test to Regulatory-agency Specifications

The radiated emissions measurement software includes a library of test limits for all major regulatory agencies—FCC, FTZ, and VCCI. This eliminates the need to create a set of limits before final compliance testing. Also, you can verify test results manually while the software is running and then return to program control by just pressing a key.

#### Customize Tests and Measurement Reports

You can reconfigure tests easily by defining measurement routines that will automatically execute commands in the order you establish. The software also allows you to test to your own limits and to set receiver parameters to meet specific needs. An automated report generator records test results in graphic and tabular formats. Text can be integrated to produce concise, professional-looking reports. Storage libraries allow you to save, update, and reprint your reports.

#### Use Selected PCs

The radiated emissions measurement software runs on HP personal computers with HP BASIC language processors and 3 Mbytes of RAM. It also operates with selected IBM-compatible PCs using HP BASIC language processors and 3 Mbytes of RAM.

#### Compatibility

The HP 85869A and 85769A are compatible with the following equipment. Compatible firmware datecodes vary.

Spectrum analyzers\*\*: HP 8566B, 8567A, 8568B

RF preselector: HP 85685A

Quasi-peak adapter: HP 85650A

EMI receivers: HP 8573B, 8574B

Antenna towers: HP 11968A (HP-IB), 11968B

Turntables: HP 11968D (HP-IB), 11968E

Transducers: HP 11966 Series

Computers\*\*: HP 9000 Series 200 Models 236, 236C; HP 9000 Series 300 Models 310, 319, 320, 330, 332, 340, 350, 360, 370; and other personal computers. See data sheet for more information.

Memory requirements\*\* 3 Mbytes

Mass Storage\*\* HP 9122C, 9153C

Plotters HP 7440A, 7475A, 7550A

Printers HP 2225A ThinkJet, HP 2227B QuietJet Plus, HP 2276A

DeskJet, HP 33440A LaserJet Series II

\*Quasi-peak measurements available by adding option 103 to HP 8591A or 8593A spectrum analyzers.

\*\*Minimum equipment required

#### Ordering Information

	Price
HP 85712B EMC measurement personality card	\$860
HP 11946A quasi-peak detector/ AM-FM demodulator upgrade kit	\$1,910
HP 85869A EMI measurement software	\$0
Opt 630 3 5/8-inch disks	\$7,000
Opt 655 5 1/4-inch disks	\$7,000
Opt 830 upgrade kit for HP 85864A/B/C software, 3 1/2-inch disks	\$500
Opt 855 upgrade kit for HP 85864A/B/C software, 5 1/4-inch disks	\$500
HP 85879A radiated emissions measurement software	\$0
Opt 630 3 1/2-inch disks	\$8,000
Opt 655 5 1/4-inch disks	\$8,000
Opt 830 upgrade kit for HP 85870A software, 3 1/2-inch disks	\$850
Opt 855 upgrade kit for HP 85870A software, 5 1/4-inch disks	\$850

# SIGNAL ANALYZERS

## EMC Development Products

Design Course, Accessories

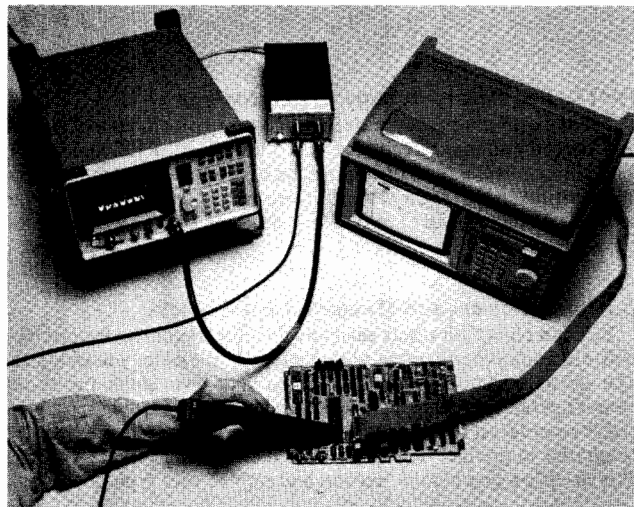

"HP can show you how to design for electromagnetic compatibility"

### HP 11949A EMC Design Course

"Designing for EMC" is a two-day course for engineers who face issues of electromagnetic compatibility. Emphasis is placed on evaluating and solving EMC problems early in the design phase of a product, rather than during final EMC compliance testing. Expert instruction and many demonstrations provide EMC fundamentals, methods of measuring EMC, and principles of incorporating proven EMC design into products.

Topics covered in the course are the following: overview of EMC design, non-conducted coupling, common impedance coupling, radiation from digital circuits, cables, advanced cables, conducted emissions, susceptibility, electrostatic discharge, shielding, and diagnostics. The 11-chapter handbook used in class becomes a permanent reference. To register, call 1-800-HP CLASS in the U.S. or contact your nearest HP Education Center listed on page 726.

### HP 8566B/68B Option 462 Impulse Bandwidths

Option 462 for the HP 8566B and 8568B spectrum analyzers provides impulse bandwidths for making MIL-STD and DEF STAN EMI measurements. Standard HP 8566B and 8568B models have 12 resolution bandwidth filters (10 Hz to 3 MHz in a 1, 3, 10 sequence) specified in terms of their 3-dB bandwidth. Option 462 modifies the

1-kHz to 3-MHz resolution bandwidth filters to correspond to their impulse bandwidth instead.

In addition to enhancing instrument capability for MIL-STD 461A/B/C and 462 EMI measurements, spectrum analyzers with option 462 can still make all commercial EMI and general-purpose measurements. Option 462 spectrum analyzers are compatible with the HP 85650A quasi-peak adapter, HP 85685A RF preselector, HP 85869A EMI measurement software, HP 85879A radiated emissions measurement software, and HP 85867A EMI receiver functions program. Existing HP 8566B and 8568B spectrum analyzers can be modified to include this option. For more information, contact your local sales office listed on page 737.

### EMC Accessories Catalog

More complete descriptions and specifications of HP growing line of accessories and transducers can be found in the EMC Accessories Catalog, HP literature number 5952-1791. This free catalog is available from your local sales office listed on page 737.

### HP 11940A and 11941A Close-field Probes

These handheld probes are designed to measure magnetic-field radiation from surface currents, slots, cables, and ICs for EMC diagnostic and troubleshooting measurements. Their unique design results in a high level of electric-field rejection. This significantly reduces errors, thus allowing calibrated and repeatable measurements.

The HP 11941A operates from 9 kHz to 30 MHz; the HP 11940A, from 30 MHz to 1 GHz. Five antenna factors appear on each probe for calculating absolute magnetic-field strength ( $\text{dB}\mu\text{A}/\text{m}$ ) from the  $\text{dB}\mu\text{V}$  reading of a spectrum analyzer. Each probe is calibrated and comes with a two-meter, RG-223 coaxial cable, and SMA (f)-to-type N (m) adapter, and an SMA (f)-to-BNC (m) adapter.

### HP 11945A Close-Field Probe Set

The close-field probe set includes both the HP 11940A and 11941A probes for full coverage from 9 kHz to 1 GHz. Option E51 adds the HP 8447F option H64 dual preamplifier, a 36-inch (914 mm) type N cable, and a carrying bag for storage and protection of the entire set.

### HP 11947A Transient Limiter

This limiter protects a spectrum analyzer input from damage caused by high-level transients from line impedance stabilization networks (LISNs) during EMI testing for conducted emissions. Frequency range is 9 kHz to 200 MHz and insertion loss is 10 dB. The transient limiter can withstand inputs as high as 10 kW for 10 us, or 2.5 W of average power. The built-in high-pass filter helps reduce 60-Hz line feedthrough that could impede conducted-emission measurements. This limiter is not required for HP 8573B and 8574B EMI receivers or other systems employing the HP 85685A RF preselector.



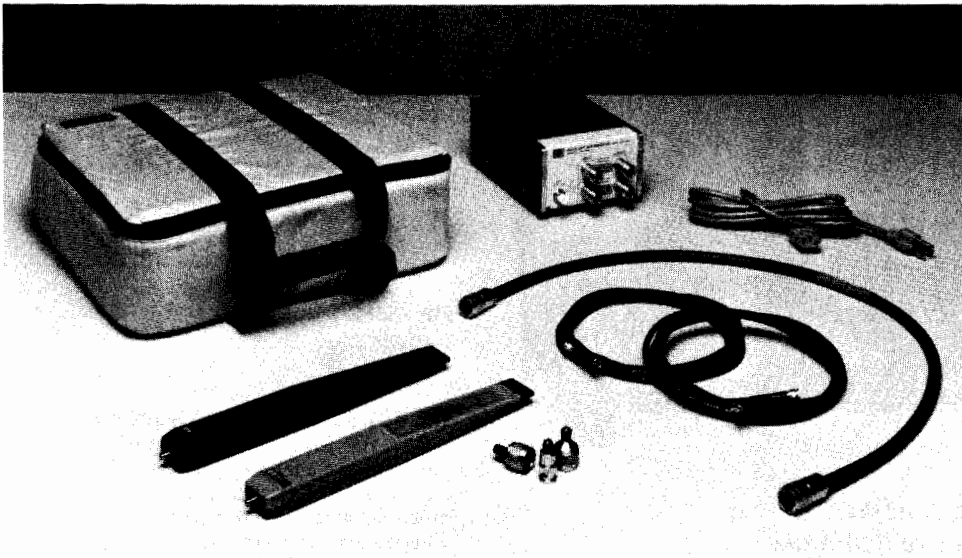

"HP has a large selection of accessories for your radiated measurements"

#### HP 11965R Current Probe Kit

Designed for MIL-STD 461/462 CE-03 measurements of conducted emissions on power and interconnecting leads, this probe has a constant transfer impedance of 0.5 ohms ( $\pm 2$  dB) from 50 kHz to 50 MHz. The kit includes two 10- $\mu$ F capacitors and a 6-foot type N cable.

#### HP 11966 Series Antennas

These antennas are individually calibrated and shipped with a calibration certificate showing actual performance data. The series includes the following products:

HP Model	Frequency Range
HP 11966A active loop H-field antenna	10 kHz to 30 MHz
HP 11966B active rod E-field antenna	30 Hz to 50 MHz
HP 11966C biconical antenna	30 MHz to 300 MHz
HP 11966D log periodic antenna	200 MHz to 1 GHz
HP 11966E double ridged waveguide horn antenna	1 GHz to 18 GHz
HP 11966F conical log spiral antenna	200 MHz to 1 GHz
HP 11966G conical log spiral antenna	1 GHz to 10 GHz
HP 11966H dipole antenna set	28 MHz to 1 GHz
HP 11966K magnetic field pickup coil	20 Hz to 50 kHz

#### HP 11967C Line Impedance Stabilization Network

Used for commercial, CISPR-based conducted emission measurements, this single-phase unit meets requirements of the FCC and VDE for conducted emission testing. Includes color-coded pin plugs for constructing a power cord to connect with the LISN.

#### HP 11968 Series Antenna Masts

Antenna-positioning masts include the motorized, HP-IB programmable HP 11968A and the manually operated HP 11968B.

#### HP 11968C Antenna Tripod

Non-metallic, this antenna tripod minimizes unwanted reflections in the test environment.

#### HP 11968 Series Turntables

Equipment-testing turntables include the motorized, HP-IB programmable HP 11968D and the manually operated HP 11968E.

#### 11729-60014 Low Noise Preamp

This amplifier provides the sensitivity needed for MIL-STD 461C CE-06 receiver/transmitter key-up testing. Frequency range is 10 Hz to 25 MHz.

#### HP 8447F Option H64 Dual Preamp

Improve receiver and spectrum analyzer sensitivity for more accurate radiated emission measurements. This dual preamplifier is ideal for use with the HP 11940A and 11941A close-field probes to detect low-level signals from a device under test. Frequency range is 9 kHz to 1.3 GHz. See page 425.

#### HP 8449B Microwave Preamp

This high-gain, low-noise preamplifier adds sensitivity for MIL-STD radiated measurements. Frequency range is 1 GHz to 26.5 GHz. See page 427.

#### Ordering Information

Item	Price
HP 11949A "Designing for EMC" course	\$750
HP 8566B/8568B option 462 impulse bandwidths	\$2,040
HP 11940A close-field probe, 30 MHz to 1 GHz	\$665
HP 11941A close-field probe, 9 kHz to 30 MHz	\$665
HP 11945A close-field probe set, 9 kHz to 1 GHz	\$1,140
Opt 001 rotary joint (requires 2 each)	+\$385
Opt 003 delete cables and adapters (2 sets)	-\$200
Opt E51 HP 8447F option H64 preamplifier, carrying bag, 36-inch type N cable	+\$2,500
HP 11947A transient limiter, 9 kHz to 200 MHz	\$480
HP 11965A current probe kit, 15 kHz to 50 MHz	\$1,660
HP 11966A active loop H-field antenna, 10 kHz to 30 MHz	\$2,375
HP 11966B active rod E-field antenna, 30 MHz to 50 MHz	\$2,100
HP 11966C biconical antenna, 30 MHz to 300 MHz	\$1,550
HP 11966D log periodic antenna, 200 MHz to 1 GHz	\$1,800
HP 11966E double ridged waveguide horn antenna, 1 to 18 GHz	\$3,100
HP 11966F conical log spiral antenna, 200 MHz to 1 GHz	\$1,850
HP 11966G conical log spiral antenna, 1 to 10 GHz	\$1,700
HP 11966H dipole antenna set, 28 MHz to 1 GHz	\$3,700
HP 11966K magnetic field pickup coil, 20 Hz to 50 kHz	\$550
HP 11967C line impedance stabilization network	\$2,700
HP 11968A motorized antenna positioning mast	\$17,850
HP 11968B manual antenna positioning mast	\$3,000
HP 11968C antenna tripod	\$725
HP 11968D motorized equipment testing turntable	\$10,850
HP 11968E manual equipment testing turntable	\$1,525
11729-60014 low noise preamplifier, 10 Hz to 25 MHz	\$525
HP 8447F opt H64 dual preamplifier, 9 kHz to 1.3 GHz	\$2,610
HP 8449B microwave preamplifier, 1 to 26.5 GHz	\$7,000

☎ For same-day service, call HP DIRECT at 800-538-8787.

# SIGNAL ANALYZERS

## Low-frequency Spectrum and Wave Analyzers, 0.02 to 32.5 MHz

### HP 3581A/C, 3586C

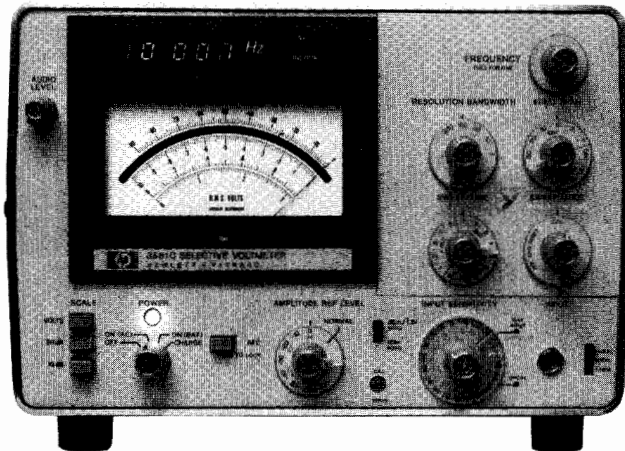

HP 3581C

### HP 3581A Wave Analyzer, HP 3581C Selective Voltmeter

The HP 3581A wave analyzer and HP 3581C selective voltmeter cover the 15 Hz to 50 kHz frequency range and are optimized for general-purpose and telecommunications measurements, respectively. Both provide measurements of the amplitude and frequency of spectral components in a portable, easy-to-use package.

The 30 nanovolt sensitivity of the analyzer allows measurement of even the smallest signals or transducer inputs. Drifting signals are accurately measured after locking on to them with the built-in AFC circuit. A digital readout provides indication of tuned frequency with 1 Hz resolution.

Other features include linear and logarithmic amplitude scales, X-Y recorder output, and optional internal rechargeable battery power. The HP 3581C also offers balanced/bridged and 600/900  $\Omega$  balanced/terminated inputs to test service circuits in both inside and outside plant maintenance.

### HP 3581A/C Specifications (abbreviated)

#### Frequency characteristics:

**Range:** 15 Hz to 150 kHz

**Display:** 5 digit LED readout.

**Resolution:** 1 Hz

**Accuracy:**  $\pm 3$  Hz, 0 to 55  $^{\circ}$  C

**Typical stability:**  $\pm 10$  Hz/hour after 1 hour and  $\pm 5$  Hz/ $^{\circ}$  C

**Automatic frequency control (AFC) hold-in range:**  $\pm 800$  Hz.

#### Amplitude characteristics

##### Instrument range

Linear: 30 V to 100 nV full scale.

Log:  $\pm 30$  dBm or dBV to -150 dBm or dBV.

Amplitude accuracy	Log	Linear
Frequency Response 15 Hz - 50 kHz	$\pm 0.4$ dB	$\pm 4\%$

**Dynamic range:**  $> 80$  dB

**Spurious responses:**  $> 80$  dB below input reference level

#### Ordering Information

	Price
HP 3581A Wave analyzer	\$7,330
HP 3581C Selective voltmeter	\$8,230
Opt 001 Battery pack, dust cover	+ \$720
Opt 003 Rack mount	+ \$345
Opt W30 Extended repair service. See page 723	\$190

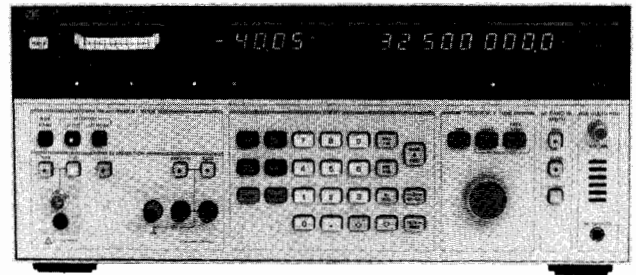

HP 3586C



### HP 3586C Selective Level Meter

The HP 3586C selective level meter is designed for general-purpose wave analysis applications in the design, manufacture, and maintenance of electronic systems. The HP 3586C is fully HP-IB programmable and covers the frequency range of 50 Hz to 32.5 MHz, allowing measurement of audio, sonar, and other low-frequency systems, as well as high-frequency communications subsystems. Input impedances of 50, 75, and 600  $\Omega$  are provided with 10 k $\Omega$  bridging for maximum measurement flexibility in a wide variety of applications. Signal levels are measured with up to  $\pm 0.2$  dB accuracy down to -80 dB, with 0.01 dB resolution and bandwidth choices of 20, 400, or 3100 Hz. The built-in counter and narrow-resolution bandwidths allow harmonic and intermodulation measurements to be made with ease. Frequency can be set or measured with 0.1 Hz resolution and  $\pm 10$  ppm stability ( $\pm 0.2$  ppm optional).

For frequency response measurement of high-Q filters and other selective networks, the companion HP 3336C synthesizer/level generator functions as a full-featured, HP-IB programmable tracking generator. Frequency range for the HP 3336C is 10 Hz to 21 MHz, with precise output levels from -70 to +8 dBm.

### HP 3586C Specifications (abbreviated)

#### Frequency

**Range:** 50/70  $\Omega$  unbalanced input, 50 Hz to 32.5 MHz; 600  $\Omega$  balanced input, 50 Hz to 108 kHz

**Resolution:** 0.1 Hz

**Center frequency accuracy:**  $\pm 1 \times 10^{-5}$ /year ( $\pm 2 \times 10^{-7}$ /year with option 004).

#### Selectivity

**3dB bandwidth:**  $\pm 10\%$ : 20 Hz, 400 Hz, 3100 Hz

**Pass band flatness:**  $\pm 0.3$  dB

**Level accuracy (+20 to -80 dB):**  
 $\pm 0.20$  dBm, 20 kHz - 18 MHz  
 $\pm 0.25$  dBm, 18 MHz - 32.5 MHz

#### Ordering Information

	Price
HP 3586C Selective Level Meter	\$11,850
Opt 004 High-Stability Frequency Reference	+ \$775
Opt 907 Front Panel Handles	+ \$68
Opt 908 Rack Flange Kit	+ \$37
Opt 909 Rack Flange & Handle Combination Kit	\$95
Opt W30 Extended repair service. See page 723	\$275

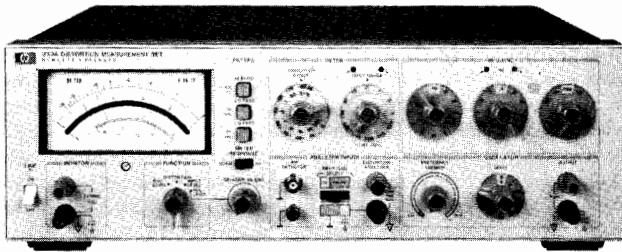

HP 339A

### HP 339A Distortion Measurement Set

The HP 339A Distortion Measurement Set is an ultralow distortion measuring system complete with total harmonic distortion (THD) analyzer, true rms voltmeter, and sinewave oscillator. This lightweight bench instrument allows you to make THD measurements over the 10 Hz to 110 kHz frequency band, including harmonics to 330 kHz.

With the built-in tracking oscillator in the HP 339A, you only need to tune one instrument instead of two. Input filters are included to speed test time. The 30 kHz low pass filter provides the band limiting required by FCC proof-of-performance broadcast testing. An 80 kHz low pass filter and 400 Hz high pass filter reduce high frequency noise and line frequency hum.

#### Distortion Measurements

The fundamental frequency range is 10 Hz to 110 kHz with continuous frequency coverage with 2 digit resolution. The distortion analyzer and oscillator are tuned simultaneously. Distortion measurement range is 100% to 0.01%, (0 dB to -80 dB).

#### Specifications

##### Distortion measurement accuracy

- 20 Hz to 20 kHz:  $\pm 1$  dB
- 10 Hz to 50 kHz: +1, -2 dB
- 50 kHz to 110 kHz: +1.5, -4 dB

##### Distortion introduced by instrument (input > 1V rms)

- 10 Hz to 10 kHz <-95 dB (0.0018%) THD
- 10 kHz to 20 kHz <-92 dB (0.0035%) THD
- 20 kHz to 30 kHz <-90 dB (0.0056%) THD
- 30 kHz to 50 kHz <-85 dB (0.01%) THD
- 50 kHz to 110 kHz <-70 dB (0.032%) THD

#### Oscillator

Frequency range is 10 Hz to 100 kHz with 2 digit resolution. Output level is variable from 4V rms to 1 mV rms.

##### Oscillator distortion (>600 ohm load, <3 Vrms)

- 10 Hz to 20 kHz <-93 dB (0.0022%) THD
- 20 kHz to 30 kHz <-85 dB (0.0056%) THD
- 30 kHz to 50 kHz <-80 dB (0.01%) THD
- 50 kHz to 80 kHz <-70 dB (0.032%) THD
- 80 kHz to 110 kHz <-65 dB (0.056%) THD

#### Voltmeter

Range is 1 mV rms full scale to 300 V rms full scale (-60 dB to +50 dB with the meter calibrated in dBV to 600 ohms). Option 001 provides increased sensitivity to 0.1 mV rms (-80 dBV).

##### Voltmeter accuracy

- 1 mV to 300 V Ranges
- 20 Hz to 20 kHz:  $\pm 2\%$
- 10 Hz to 110 kHz:  $\pm 4\%$
- .1 mV and .3 mV ranges
- 20 Hz to 20 kHz:  $\pm 2\%$
- 10 Hz to 30 kHz:  $\pm 4\%$
- 30 kHz to 80 kHz: +10% to -30%

#### General

- Power:** 100/120/220/240 V +5%, -10%, 48 Hz to 66 Hz line operation, 200 mA maximum.
- Size:** 146H x 426W x 375mmD (5.75" x 16.75" x 14.75")
- Weight:** net, 8.2kg (18lb); shipping, 11.3kg (25lb)

#### Ordering Information

- HP 339A Distortion Measurement Set \$4500
- Opt 001 Increased Sensitivity \$290
- Opt W30 Extended Repair Service. See page 723. \$105

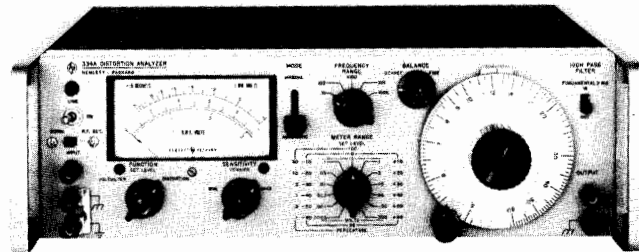

HP 334A

### HP 334A Distortion Analyzer

The HP 334A Distortion Analyzer measures total distortion down to 0.1% full scale at any fundamental frequency between 5 Hz and 600 kHz; harmonics are indicated up to 3 MHz. Noise levels as low as 25 microvolts can be measured. The HP 334A includes automatic fundamental nulling and amplitude modulation detector. A meter with VU ballistic characteristics and a 30 kHz low pass filter are optional.

#### Specifications

Input level for distortion measurements: 0.3 V rms for 100% set level or 0.245 V for 0 dB set level (up to 300 V may be attenuated to set level reference).

#### Harmonic measurement accuracy (full scale) Fundamental input less than 30 V

Range	$\pm 3\%$	$\pm 6\%$	$\pm 12\%$
100%-0.3%	10 Hz-1 MHz	10 Hz-3 MHz	
0.1%	30 Hz-300 kHz	20 Hz-500 kHz	10 Hz-600 kHz

##### Fundamental rejection: >80 dB

**Residual distortion:** >-70 dB (0.03%) from 5 Hz to 200 kHz; >-64 dB (0.06%) from 200 kHz to 600 kHz. Meter indication is proportional to average value of a sine wave.

**Frequency calibration accuracy:** Better than  $\pm 5\%$  from 5 Hz to 300 kHz. Better than  $\pm 10\%$  from 300 to 600 kHz.

**Input impedance:** Distortion mode: 1 M $\Omega$   $\pm 5\%$  shunted by <70 pF

**DC isolation:** Signal ground may be  $\pm 400$  V dc from external chassis

**Voltmeter range:** 300  $\mu$ V to 300 V rms full scale (13 ranges) 10 dB per range. Average responding calibrated in rms.

**Noise measurements:** Voltmeter residual noise on the 300  $\mu$ V range: <25  $\mu$ V rms, when terminated in 600 (shielded) ohms.

**Output:** 0.1  $\pm$  0.01 V rms open circuit

**Output impedance:** 2k $\Omega$

**Automatic nulling mode:** Set level: at least 0.2 V rms

**Frequency ranges:** X1, manual null tuned to less than 3% set level; total frequency hold-in  $\pm 0.5\%$  about true manual null. X10 through X10k, manual null tuned to less than 10% of set level; total frequency hold-in  $\pm 1\%$  about true manual null.

**Automatic null accuracy:** 5 Hz to 100 Hz: meter reading within 0 to +3 dB of manual null. 100 Hz to 600 kHz: meter reading within 0 to +1.5 dB of manual null.

**High pass filter:** 3 dB point at 400 Hz with 18 dB per octave roll off. AM detector: 550 kHz to 65 MHz; 40 Vp-p max input.

**Distortion introduced by detector:** Carrier frequency: 550 kHz-1.6 MHz: <50 dB (0.3%) for 3-8 V rms carriers modulated 30%.

#### General

- Power:** 100V/120V/240V -10% +5%, 48-66 Hz
- Size:** 426W x 126H x 337mmD (16.75" x 5" x 13.25")
- Weight:** net, 7.89kg (17.75lb); shipping, 10.35kg (23lb)

#### Ordering Information

- HP 334A Distortion Analyzer \$4200
- Opt 001 VU Characteristics +\$26
- Opt 002 30 kHz Low Pass Filter +\$134
- Opt 003 (combined 001 and 002) +\$155
- Opt W30 Extended Repair Service See page 723. +\$95

# SIGNAL ANALYZERS

## Automated Spectrum Analysis

### HP 3048A

Calibrated, Automated Phase Noise Measurements with

- Specified amplitude accuracy of  $\pm 2$  dB
- Offset frequency range of 0.01 Hz to 40 MHz
- Carrier frequency range from 5 MHz to beyond 18 GHz
- Spurs separated from noise spectra

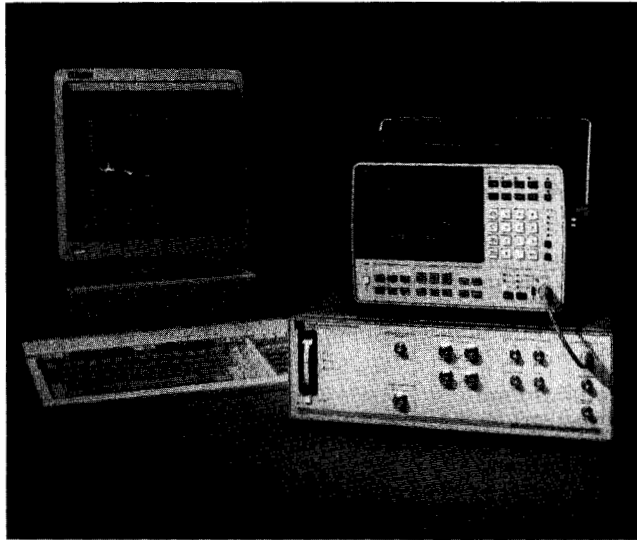

HP 3048A Phase Noise Measurement System controlled by an HP 98580C Desktop Computer.

#### HP 3048A Phase Noise Measurement System

The HP 3048A phase noise measurement system uses the power of a flexible software program to automate phase noise carrier measurements. The basic HP 3048A system includes the HP 11848A phase noise interface containing the phase detectors and phase-lock loop circuitry, the HP 3561A dynamic signal analyzer, measurement software, and a comprehensive operator training course. Using the HP 98580C desktop computer (or PC-compatible, with option 301), the basic system measures carrier frequencies from 5 MHz to 1.6 GHz (to 18 GHz with option 201) and characterizes the demodulated phase noise over an offset range of 0.01 Hz to 100 kHz. Adding an RF spectrum analyzer such as the HP 3585A/B provides automated measurements to offsets of 40 MHz. A variety of signal generators such as the HP 8662A, HP 8663A, or HP 8642A/B can also be added to the system to provide a low-noise reference signal up to a frequency of 2.56 GHz.

#### Measurements above 1.6 GHz

Adding an HP 11729C carrier noise test set in combination with an HP 8662A or HP 8663A provides a low-noise reference signal for measuring carrier signals up to 18 GHz. The local oscillator is gen-

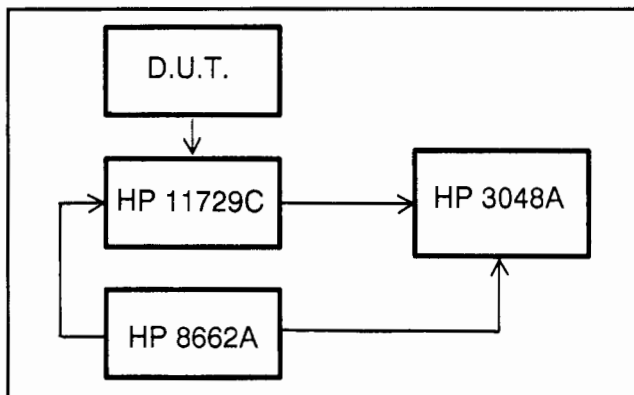

HP 3048A Phase Noise Measurement System extended to 18 GHz

erated from the 640 MHz rear panel auxiliary output of the HP 8662A (or HP 8663A). Using this reference, a step recovery diode (internal to the HP 11729C) generates a series of harmonics up to approximately 18 GHz that are used to downconvert the microwave signal. The HP 11729C downconverts microwave signal sources to an intermediate frequency between 5 and 1280 MHz, a range where tunable, low noise references are available. A bandpass filter is used to apply the correct harmonic to the mixer for down-conversion of the microwave input signal. With the down-converted microwave signal and a reference oscillator, a fully calibrated phase noise measurement of the microwave signal can be made.

To extend the frequency range of the HP 3048A to millimeter wave frequencies (up to 110 GHz), there are special options available for both the HP 3048A and the HP 11729C. For complete information regarding millimeter-wave extensions to the HP 3048A, consult Application Note 385, *Millimeter Measurements Using the HP 3048A Phase Noise Measurement System* (P/N 5951-6749) or contact your local Hewlett-Packard sales office.

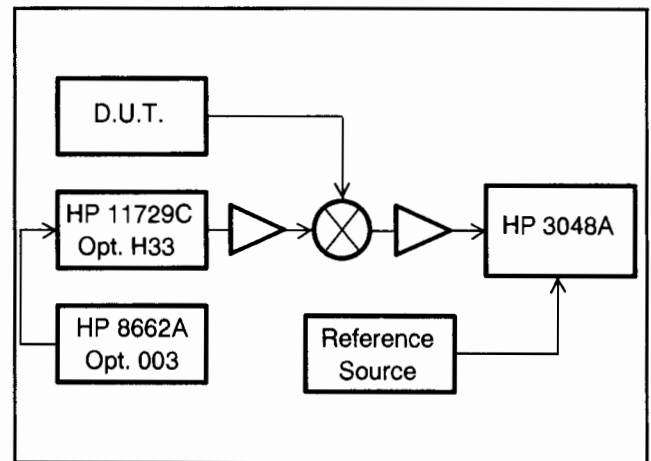

HP 3048A extended to 110 GHz

In both the microwave and millimeter down-conversion setups, the random phase noise contribution of the HP 11729C/HP 8662A combination is dominated by the multiplied absolute noise of the HP 8662A auxiliary 640 MHz rear-panel output.

#### Phase Noise Measurement Software

The HP 3048A system software uses the HP 11848A interface to demodulate the phase noise of a carrier in the frequency range of 5 MHz to 18 GHz (and beyond with external, user-supplied mixers) and measures the resulting baseband signal with the analyzers. Measurement menus allow the operator to specify the measurement process, including the calibration of the system. Several output formats are available to the user, including plots of the single sideband phase noise power of a signal, integrated noise power, or the calculated Allen variance. A real-time measurement mode is available to monitor the level of phase noise and discrete spurs as changes are made to the device under test. The phase noise measurement software is available in both RMB workstation or MS-DOS® PC-compatible formats.

As measured by the HP 3048A, the term *phase-noise* includes all forms of a signal's frequency and phase instabilities. Randomly occurring frequency and phase modulation, as well as discrete sidebands resulting from power-line phase modulation and phase jitter, are detected and accurately measured. Coherent signals are displayed at the power level that was detected while random phase signals are normalized for a 1 Hz bandwidth. The recommended phase noise measurement technique is the phase detector method which requires a reference oscillator with adequate noise performance and tuning capability.

MS-DOS is a U.S. registered trademark of Microsoft Corp

- Down-converts 1.28 to 18 GHz signals
- Low noise floor

**Specifications Summary**

**Sensitivity**

The following graph indicates the sensitivity of the HP 3048A system as limited by its own internally-generated noise for a signal under test at +15 dBm. Also plotted is the phase noise that would limit the measurement sensitivity for a 1 GHz signal using the phase detector measurement method and the HP 8662A or HP 8663A as a reference source.

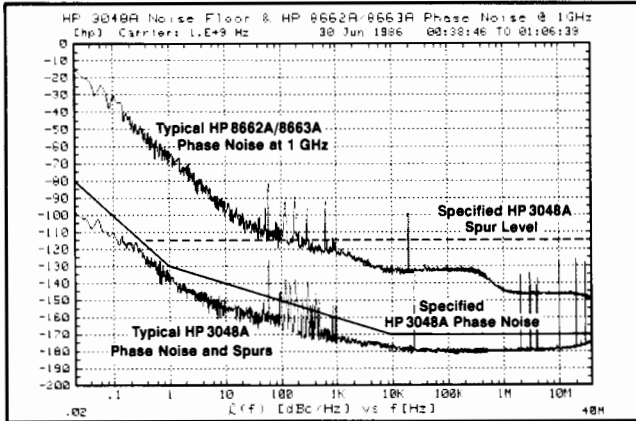

**Carrier frequency range**

**Internal mixer:** 5 MHz to 1.6 GHz, optional to 18 GHz  
**External (user-supplied) mixer:** The frequency range of the carrier is limited only by the frequency range of the external mixer.  
**Offset frequency range:** 0.01 Hz to 100 kHz, extended to 40 MHz with an optional spectrum analyzer such as the HP 3585B.  
**Amplitude accuracy:** ±2 dB to 1 MHz offsets; ±4 dB for offsets greater than 1 MHz. This accuracy is verified by the system at the time of the measurement. If there are any accuracy degradations, the system will advise the user during the measurement.

**Ordering Information**

**Price**

**HP 3048A** phase noise measurement system \$36,100  
 Includes the HP 11848A Phase Noise Interface, HP 3561A Dynamic Signal Analyzer, RMB workstation based measurement software and operator training.

**Reference oscillator options**

- Opt 001** Adds HP 8662A Opt 003 synthesized signal generator (0.01 to 1280 MHz) +\$39,085
- Opt 002** Adds HP 8663A Opt 003 synthesized signal generator (0.1 to 2560 MHz) +\$53,775
- Opt 003** Adds HP 11729C carrier noise test set (1.28 to 18 GHz) +\$25,450
- Opt 004** Adds HP 11729C Opt 130 carrier noise test set. +\$27,255
- Opt 006** Adds HP 8642B Opt 001 synthesized signal generator (0.1 to 2114 MHz) +\$40,550

**Software option**

- Opt 301** Replaces standard RMB workstation phase noise software with MS-DOS PC-compatible phase noise software. A graphics dump utility is included with this option. \$0

**System computers**

**HP 3048A Standard:** HP 98580C Opt 104 and HP-HIL Knob (HP 46083A).

**HP 3048A Opt 301:** IBM PC/AT/XT and true compatibles with 640 Kbytes RAM; MS-DOS 2.0 or later; EGA or compatible video card with 128 Kbytes video RAM; EGA or compatible color display; HP-IB card (recommend HP 82335A HP-IB card<sup>1</sup>).

For full details on available system options and ordering information, see the HP 3048A phase noise measurement system technical data (5953-8462).

<sup>1</sup>Also operates with National Instruments PC-II and PC-11A GP-IB cards.

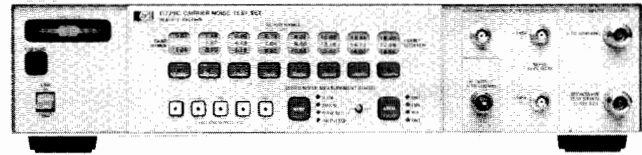

HP 11729C



**HP 11729C Carrier Noise Test Set**

The HP 11729C is a fully programmable microwave downconverter used primarily as an accessory to the HP 3048A phase noise measurement system. The input frequency range of the HP 11729C is 1.28 to 18 GHz and IF bandwidth is 5 to 1280 MHz. With option 130, the HP 11729C can be used as an AM noise demodulator for carriers from 10 MHz to 18 GHz. The baseband demodulated signal is input to the HP 3048A for calibrated AM noise measurements.

**Specifications Summary**

**Downconverter**

**Frequency range:** 1.28 to 18 GHz in 8 bands  
**Amplitude:** +7 dBm minimum  
 +18 dBm maximum

**IF output**

**Bandwidth:** 5 to 1280 MHz  
**Level:** +7 dBm minimum

**AM noise detection (Option 130)**

**Frequency range:** 10 MHz to 18 GHz  
**Input level:** 0 dBm minimum  
 +18 dBm maximum

**AM noise floor (at +10 dBm input level, dBc/Hz):**

Offset from carrier	Typical	Specified
1kHz	-147	-138
10kHz	-152	-145
100kHz	-161	-155
1MHz	-165	-160

**General**

**Operating temperature range:** 0° to +55°C  
**Power:** 100, 120, 220, 240 V, +5%, -10%; 48 to 66 Hz; <75 VA max.  
**Weight:** net, 10.4 kg (23 lb); shipping, 13.6 (30 lb)  
**Size:** 99 H x 425 W x 551 mm D (16.8" x 21.7" x 3.9").  
 1MW x 3' H x 20 D System II module

**Ordering Information**

**Price**

**HP 11729C** carrier noise test set (10 MHz to 18 GHz)<sup>1</sup> \$25,450

Note: Each of options 003 through 027 (only one may be ordered) also includes 0.005 to 1.28 GHz coverage which is not used for downconversion.

- Opt 003** (1.28 to 3.2 GHz) -\$8,500
- Opt 007** (3.2 to 5.76 GHz) -\$8,500
- Opt 011** (5.76 to 8.32 GHz) -\$8,500
- Opt 015** (8.32 to 10.88 GHz) -\$8,500
- Opt 019** (10.88 to 13.44 GHz) -\$8,500
- Opt 023** (13.44 to 16.0 GHz) -\$8,500
- Opt 027** (16.0 to 18.0 GHz) -\$8,500
- Opt 130** AM noise detection +\$1,805
- Opt 140** Rear panel connectors +\$515
- Opt 907** Front handle kit (5061-9688) +\$57
- Opt 908** Rack flange kit (5061-9674) +\$36
- Opt 909** Rack flange kit with front handles (5061-9675) +\$82
- Opt 910** A total of two sets of operation and service manuals (11729-90017) +\$36
- Opt W30** Extended repair service, see page 723 +\$140

<sup>1</sup> Extends to 10 MHz for AM detection only.

☎ For same day shipment, call HP DIRECT at 800-538-8787

# SIGNAL ANALYZERS

## Vector Modulation Analysis, dc-350MHz, 50-200MHz

### HP 8980A, 8981A

#### HP 8980A, HP 8981A

- Analyzes coherent phase and amplitude modulation
- 350 MHz Q vs. I bandwidth
- Markers for measuring phase, amplitude, and time
- 12 bit digitizing for HP-IB measurements.

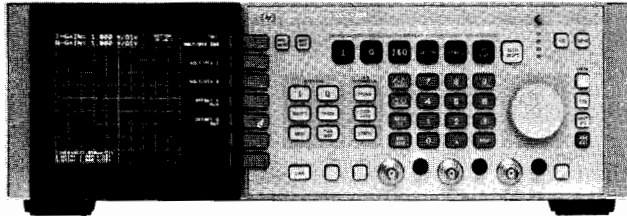

HP 8980A

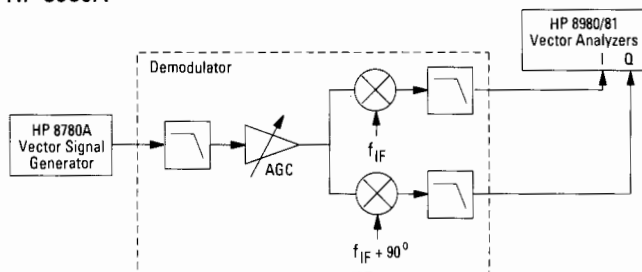

The HP 8980A Vector Analyzer and the HP 8780A Vector Signal Generator can be used to adjust and troubleshoot an I/Q demodulator directly. The I/Q outputs of the demodulator are connected directly to the HP 8980A. The HP 8980A Vector Analyzer can display the constellations of high-rate modulation schemes such as QPSK, 16QAM, 49PRS, 64QAM, and 56QAM. It also makes statistical measures of system quality like closure, lock angle error and quadrature error.

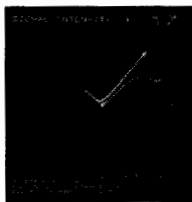

UMOP (Unintentional-Modulation-on Pulse) is identified by quantitatively measuring the phase transients on a radar pulse with the delta-phase measurement marker.



Display of vector demodulated SAW chirp signals. The spiraling phase response indicates the changing chirp frequency and amplitude.

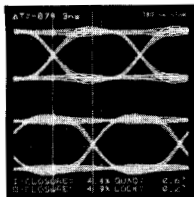

I & Q display: each I and Q channel is displayed vs. time on a separate grid, one above the other.

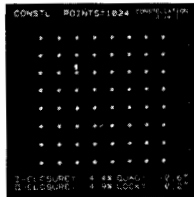

Constellation display: displays Q vs. I at the time instant defined by the time marker.

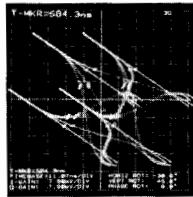

3D display: useful for visual, or intuitive, analysis of Q vs. I vs. time waveforms. Signal can be rotated about any of three axes for optimal viewing.

#### HP 8981A adds built-in I/Q demodulator with:

- 50 - 200 MHz modulated IF input frequency range
- 100 MHz baseband bandwidth with external I/Q filters and 35 MHz with internal filters
- Automatic internal/external demodulator calibration

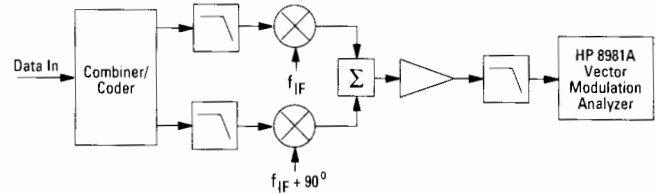

#### HP 8980/81A Vector Modulation Analyzer

The HP 8981A Vector Analyzer is a superset of the HP 8980A. It also analyzes the analog I and Q signals, but because it contains a calibrated demodulator it can be connected to the IF of the modulator. This gives the user the flexibility to examine the changes in modulation down through the receiver chain and isolate faults quickly.

#### Specifications

##### HP 8980A, 8981A

##### I and Q channels

**Bandwidth (-3dB):** 350 MHz dc coupled; approximately 1 KHz to 350 MHz, ac coupled

**dc vector accuracy using internal ADC:**  $\pm 1\%$  of full scale (or 2mV if greater)  $\pm 1\%$  of offset

**Input termination:** 50 ohms or 75 ohms

**Input coupling:** each channel independently: ac,dc, or ground (input disconnected)

##### Power Requirements

**Voltage:** 100, 120, 220, 240V ac,  $-10\%$  to  $10\%$ ; 48-66Hz

**Power:** 245 Watts, 320 VA maximum

**Dimensions:** Package is 5/4 inch rack height, one module width 23D HP System II cabinet

**Weight:** net, approximately 20kg (45lb); shipping, approximately 24kg (53lb)

#### Demodulator Correction (HP 8981A only)

A powerful routine in the HP 8981A measures and corrects demodulator errors. This routine measures the internal demodulator or external demodulator quadrature error, I/Q gain imbalance, and DC offsets. The display and digitized outputs can then be automatically adjusted to correct for these errors.

#### HP 8981A Demod Mode Specifications

**Modulated IF input frequency range:** 50 MHz to 200 MHz.

**Modulated IF input level range:**  $-5$  dBm to  $-20$  dBm.

**Coherent reference input frequency range:** 50 MHz to 200 MHz.

**Coherent reference input level range:**  $+10$  dBm to  $-20$  dBm.

**Baseband bandwidth (3 dB):** 100 MHz with external filters. Supplemental characteristic of 35 MHz with internal filters.

**Corrected vector dc accuracy at 70 MHz:** (typical from 50 to 200 MHz)  $< 2\%$  of full scale IF input.

#### Supplemental characteristics

**Quadrature Error:** Corrected:  $< \pm 0.5^\circ$  Uncorrected:  $< \pm 1^\circ$ .

**I/Q gain imbalance (dc to 10 kHz):** Corrected:  $< \pm 0.1$  dB. Uncorrected:  $< \pm 0.25$  dB.

#### Ordering Information

HP 8980A Vector Analyzer

HP 8981A Vector Modulation Analyzer

HP 11748A Active probe system

#### Price

\$27,000

\$30,300

\$3,600

# SIGNAL ANALYZERS

Audio Analyzer, 20 Hz to 100 kHz; Distortion Analyzer, 20 Hz to 100 kHz

HP 8903B, 8903E

207

- Measures distortion, SINAD, signal-to-noise
- Measures true-RMS ac volts, dc volts, frequency
- Low-distortion programmable source
- RMS, average and quasi-peak detection

- Measures distortion, SINAD
- Measures true-RMS ac volts, dc volts, frequency
- RMS, average and quasi-peak detection

Supported by  
**HP ITG**  
Software

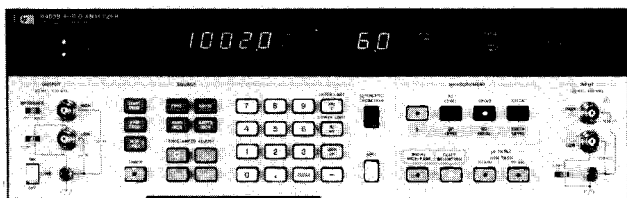

HP 8903B

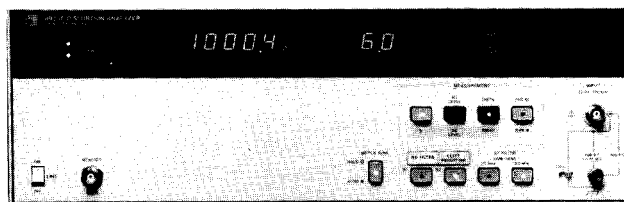

HP 8903E



## HP 8903B Audio Analyzer and HP 8903E Distortion Analyzer

The HP 8903B Audio Analyzer and HP 8903E Distortion Analyzer provide unparalleled versatility and performance for audio measurements from 20 Hz to 100 kHz. The HP 8903B combines the functionality of a low-distortion audio source, high-performance distortion analyzer, frequency counter, ac voltmeter, dc voltmeter and SINAD meter into one compact package. With microprocessor control of source and analyzer, the HP 8903B can perform stimulus-response measurements, such as signal-to-noise ratio and swept distortion, automatically with no additional equipment. The HP 8903E Distortion Analyzer is the analyzer portion of the HP 8903B Audio Analyzer. (The HP 8903E has no source.)

For ease of use, most measurements on the HP 8903B and HP 8903E are made with only one or two keystrokes. Both instruments automatically tune and autorange for maximum accuracy and resolution. For quick identification of input signals, the analyzer counts and displays the input frequency in all ac measurement modes.

### Low Frequency Applications

The HP 8903B/E have many features which make difficult audio measurements easy. These include flexible data display formats, a selectable balanced or unbalanced input, plug-in filters, and automatic notch filter tuning. With the ratio key, you can establish a reference in % or dB and directly make frequency response and 3 dB bandwidth measurements without computation. A fully balanced analyzer input allows testing of bridged power amplifiers found in many radios and car stereos as well as professional balanced audio equipment.

With two internal plug-in filter slots and six optional filters to choose from, we simplify your audio measurements by providing the filter networks required by international standards. (See the next page for a complete list of filters.) The HP 8903B and HP 8903E both use true-RMS detection (for all signals with crest factor 3) for accurate measurement of complex waveforms and noise. Average and quasi-peak detectors are also available. (Quasi-peak is selectable only via HP-IB on the HP 8903E.) Accurate distortion measurements typically can be made down to less than -90 dB (0.003%) from 20 Hz to 20 kHz.

For receiver testing, both instruments have a tunable SINAD notch filter. On the HP 8903B, the filter is automatically tuned to the source frequency. With the HP 8903E, a front-panel key allows the operator to lock the notch filter at any given input frequency.

## HP 8903B and HP 8903E Specifications

### System Specifications

(HP 8903B only, source and analyzer combined)

### Distortion

**Residual distortion and noise** (the higher of):

**80 kHz BW:** -80 dB (0.01%) or 17  $\mu$ V, 20 Hz to 20 kHz.

**500 kHz BW:** -70 dB (0.032%) or 50  $\mu$ V, 20 Hz to 50 kHz.

-65 dB (0.056%) or 50  $\mu$ V, 50 kHz to 100 kHz.

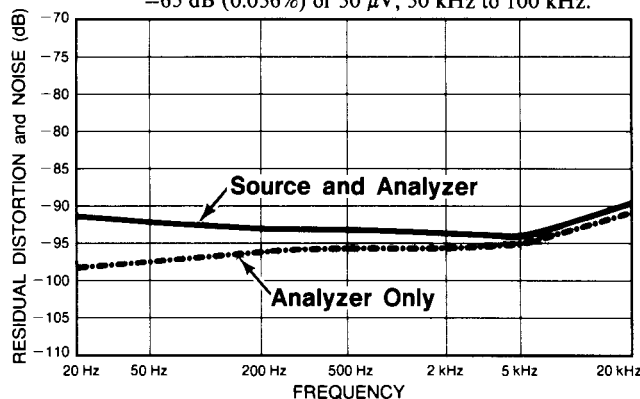

Typical residual THD + noise of source and analyzer combined (source voltage set to 1.5V, 80 kHz BW). Dashed line represents typical residual THD + noise for the analyzer only.

### Signal-to-Noise

**Frequency range:** 50 Hz to 100 kHz.

**Display range:** 0 to 99.99 dB.

**Accuracy:**  $\pm 1$  dB.

**Input voltage range:** 50 mV to 300V.

**Residual noise (the higher of):** -85 dB or 17  $\mu$ V, 80 kHz BW; -70 dB or 50  $\mu$ V, 500 kHz BW.

### Source Specifications (HP 8903B only)

#### Frequency

**Range:** 20 Hz to 100 kHz.

**Resolution:** 0.3%.

**Accuracy:** 0.3% of setting.

#### Output Level

**Range:** 0.6 mV to 6V open circuit.

**Resolution:** 0.3% or better.

**Accuracy (open circuit):** 2% of setting 60 mV to 6V, 20 Hz to 50 kHz; 3% of setting 6 mV to 6V, 20 Hz to 100 kHz; 5% of setting 0.6 mV to 6 mV, 20 Hz to 100 kHz.

# SIGNAL ANALYZERS

**Audio Analyzer, 20 Hz to 100 kHz; Distortion Analyzer, 20 Hz to 100 kHz (cont'd)**  
**HP 8903B, 8903E**

**Flatness (1 kHz reference):**  $\pm 0.7\%$  ( $\pm 0.06$  dB), 20 Hz to 20 kHz;  
 $\pm 2.5\%$  ( $\pm 0.22$  dB), 20 Hz to 100 kHz.

**Distortion and noise (the higher of):**

**80 kHz BW:**  $-80$  dB (0.01%) or  $15 \mu\text{V}$ , 20 Hz to 20 kHz.

**500 kHz BW:**  $-70$  dB (0.032%) or  $38 \mu\text{V}$ , 20 Hz to 50 kHz.

$-65$  dB (0.056%) or  $38 \mu\text{V}$ , 50 kHz to 100 kHz.

**Impedance:**  $600\Omega \pm 1\%$  or  $50\Omega \pm 2\%$ , Front panel selectable. (HP-IB programmable.)

**Sweep mode:** log sweep with up to 500 points per decade or 255 points total between entered start and stop frequencies.

## HP 8903B and HP 8903E Analyzer Specifications

### Distortion

**Fundamental frequency range:** 20 Hz to 100 kHz.

**Display range:** 0.001% to 100% ( $-99.99$  to 0 dB).

**Accuracy:**  $\pm 1$  dB, 20 Hz to 20 kHz;  $\pm 2$  dB, 20 kHz to 100 kHz.

**Input voltage range:** 50 mV to 300V.

**Residual distortion and noise (the higher of):**

**80 kHz BW:**  $-80$  dB (0.01%) or  $15 \mu\text{V}$ , 20 Hz to 20 kHz.

**500 kHz BW:**  $-70$  dB (0.032%) or  $45 \mu\text{V}$ , 20 Hz to 50 kHz.

$-65$  dB (0.056%) or  $45 \mu\text{V}$ , 50 kHz to 100 kHz.

### Supplemental Characteristics

**3 dB measurement bandwidth:** 10 Hz to 500 kHz.

**Detection:** true rms or rms calibrated average.

### SINAD

**Fundamental frequency range:** 20 Hz to 100 kHz.

**Display range:** 0 to 99.99 dB.

**Residual distortion and noise:** same as listed under Distortion.

**Accuracy:**  $\pm 1$  dB, 20 Hz to 20 kHz;  $\pm 2$  dB, 20 kHz to 100 kHz.

**Input voltage range:** 50 mV to 300V.

### Supplemental Characteristics

**Detection:** true rms or rms-calibrated average.

**Tuning:** HP 8903B: notch filter is tuned to the internal source frequency. HP 8903E: notch filter is tuned to the counted input frequency. Notch filter hold function available on front panel.

### AC Level

**Full range display:** 300.0V, 30.00V, 3.000V, .3000V, 30.00 mV, 3.000 mV, 0.3000 mV.

**Overrange:** 33%, except on 300V range.

**Accuracy:**  $\pm 2\%$ , 50 mV to 300V, 20 Hz to 20 kHz;  $\pm 4\%$ , 0.3 mV to 50 mV, 20 Hz to 100 kHz;  $\pm 4\%$ , 50 mV to 300V, 20 kHz to 100 kHz.

### Supplemental Characteristics

**AC converter:** true-rms responding for signals with crest factor up to 3, rms-calibrated average detection and quasi-peak.

**3 dB measurement bandwidth:**  $> 500$  kHz.

### DC Level

**Full range display:** 300.0V, 48.00V, 16.00V, 4.000V.

**Overrange:** 33%, except on 300V range.

**Accuracy:**  $\pm 1.0\%$  of reading, 600 mV to 300V.

$\pm 6$  mV,  $V_{in} < 600$  mV.

### Frequency Measurement

**Measurement range:** 20 Hz to 150 kHz. (20 Hz to 100 kHz in distortion and SINAD modes.)

**Resolution:** 5 digits (0.01 Hz for input frequencies  $< 100$  Hz).

**Accuracy:**  $\pm (0.004\% + 1 \text{ digit})$ .

**Sensitivity:** 50 mV in distortion and SINAD modes, 5.0 mV in ac level and signal-to-noise (HP 8903B only) modes.

### Standard Audio Filters

#### 30 kHz Low-Pass Filter

**3 dB cutoff frequency:** 30 kHz  $\pm 2$  kHz.

**Rolloff:** third-order Butterworth; 18 dB/octave or 60 dB/decade.

#### 80 kHz Low-Pass Filter

**3 dB cutoff frequency:** 80 kHz  $\pm 4$  kHz.

**Rolloff:** third-order Butterworth; 18 dB/octave or 60 dB/decade.

### Internal Plug-in Filter Options

Both the HP 8903B and HP 8903E have TWO internal plug-in filter slots, each of which will accept one of six optional filters. The standard HP 8903B and HP 8903E come with 30 kHz and 80 kHz low-pass filters, but with NO PLUG-IN FILTERS. The appropriate filter options must be ORDERED for the analyzers to have any of the filters listed below. Each filter option has TWO option numbers: the 010 series for the left filter slot and the 050 series for the right filter slot. Each filter option ordered (maximum of two) adds additional cost to the instrument.

Filters	Option Numbers	
	Left Slot	Right slot
400 Hz High-Pass	010	050
CCITT Weighting Filter	011	051
CCIR Weighting Filter	012	052
C-MESSAGE Weighting Filter	013	053
CCIR/ARM Weighting Filter	014	054
"A" Weighting Filter	015	055

### Analyzer Input

**Input type:** Balanced (full differential).

**Input impedance:** 100 k $\Omega$   $\pm 1\%$  shunted by  $< 300$  pF, each side to ground. (In dc-level mode the input resistance is 101 k $\Omega$   $\pm 1\%$ ).

**Max input (maximum peak input voltage, any combination of ac/dc):**

**HP 8903B:** 425 volts peak, applied differentially or between either input to ground.

**HP 8903E:** 42 volts peak, Low side to ground.

425 volts peak, differentially or High side to ground.

**CMRR:**  $> 60$  dB, 20 Hz to 1 kHz,  $V_{in} < 2\text{V}$ ;  $> 45$  dB, 20 Hz to 1 kHz;  $> 30$  dB, 20 Hz to 20 kHz.

### General

**Temperature:** operating, 0°C to 55°C; storage,  $-55^\circ\text{C}$  to 75°C.

**Power:** 100, 120, 220, or 240V (+5,  $-10\%$ ); 48-66 Hz. 100 or 120V +5,  $-10\%$ ; 48-440 Hz. 100 VA maximum.

**Weight:** HP 8903B: net 12.3 kg (27 lb.); shipping 16.4 kg (36 lb.) HP 8903E: net 11.8 kg (26 lb.); shipping 15.9 kg (35 lb.)

**Dimensions:** 146 mm H x 425 mm W x 462 mm D. (5.75 x 16.8 x 18.2 in.)

### Ordering Information

Analyzer Mainframes	Price
<b>HP 8903B Audio Analyzer<sup>1</sup></b>	\$6,320
Opt 001 Input/output connectors on rear panel only	+ \$105
Opt 910 2 sets of operation/calibration (08903-90079) and service manuals (08903-90062)	+ \$285 ☎
Opt 915 service manual (08903-90062)	+ \$120 ☎
Opt W30 Extended repair service. See page 723.	+ \$150
Opt W32 Calibration service. See page 723.	+ \$885

<b>HP 8903E Distortion Analyzer<sup>1</sup></b>	\$4,320
Opt 001 Input/output connectors on rear panel only	+ \$210
Opt 910 Provides an additional operation and calibration manual (08903-90053) and two service manuals (08903-90065)	+ \$295 ☎
Opt 915 Add service manual (08903-90065)	+ \$132 ☎
Opt W30 Extended repair service. See page 723.	+ \$95
Opt W32 Calibration service. See page 723.	+ \$510

### Options for both HP 8903B and HP 8903E

Opt 010 or 050 400 Hz High-Pass filter	+ \$215
Opt 011 or 051 CCITT Weighting filter	+ \$215
Opt 012 or 052 CCIR Weighting filter	+ \$215
Opt 013 or 053 C-Message Weighting filter	+ \$215
Opt 014 or 054 CCIR/ARM Weighting filter	+ \$215
Opt 015 or 055 "A" Weighting filter	+ \$215
Opt 907 Front handle kit (5061-9689)	+ \$55
Opt 908 Rack flange kit (5061-9677)	+ \$32.50
Opt 909 Rack flange kit (5061-9683) with front handles	+ \$80 ☎

<sup>1</sup>HP-IB cables not included. For description and price, see page 579.

☎ For same-day shipment, call HP DIRECT at 800-538-8787



# SIGNAL ANALYZERS

## Modulation Analyzer, 150 kHz to 1300 MHz

HP 8901A, 8901B

209

- Measures AM and FM to 1% accuracy
- Measures RF frequency
- Measures RF power

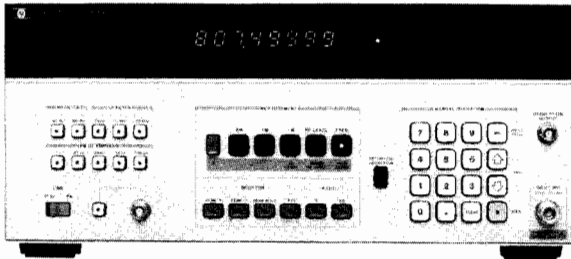

HP 8901A



### HP 8901A and HP 8901B Modulation Analyzers

The HP 8901A and HP 8901B modulation analyzers combine the capabilities of several RF instruments to give complete, accurate characterization of modulated signals in the 150 kHz to 1300 MHz frequency range. Both instruments very accurately measure modulation and recover the modulation signal. They determine RF frequency and measure RF power. The major additional capabilities of the HP 8901B are its improved power meter accuracy, its ability to use external power sensors, to make adjacent channel power measurements or carrier noise measurements (with options 030-037) and its ability to count audio frequencies and measure distortion on 400 Hz and 1 kHz signals. Both instruments are fully automatic and make all major measurements with the push of a key or under HP-IB control.

#### Transmitter Testing

The HP 8901A/B has the features required to perform standard transmitter measurements. It measures transmitter power, counts frequency, and measures the signal modulation very accurately. The HP 8901B also characterizes the demodulated audio signal's frequency, level, and distortion. With Option 030 the HP 8901B can quickly and accurately make adjacent channel power measurements to CEPT standards.

#### RF Signal Characterization

The HP 8901A/B is an excellent lab & production tool for accurately characterizing RF signals.

Use the HP 8901A/B to make accurate AM/ØM and FM/AM conversion measurements of phase and amplitude sensitive devices such as bandpass filters and multiple channel receivers. Excellent isolation between AM and FM make it simple to separate the AM and ØM of AM stereo, incidental AM of FM transmitters and the AM, FM, and ØM components of complex signals.

#### Automatic Test Systems

The HP 8901A/B is an important component of automatic RF test systems. All functions are fully automatic and easily programmed. With these measurements combined into one instrument, interfacing requirements, hardware costs, and software development time are reduced.

### HP 8901A and HP 8901B Specifications

#### RF Input

**Frequency range:** 150 kHz to 1300 MHz  
**Operating level:** 12 mVrms to 7 Vrms.  
**Input impedance:** 50Ω nominal.  
**Tuning:** manual frequency entry, automatic, or track.  
**Acquisition time (automatic operation):** ~1.5 seconds.  
**Maximum safe input level (typical):** 35 Vrms (25W for source SWR <4), ac; 40V, dc.

#### Frequency Modulation

**Rates:** 20 Hz to 200 kHz.  
**Deviations:** to 400 kHz.

- Low internal noise
- Completely automatic

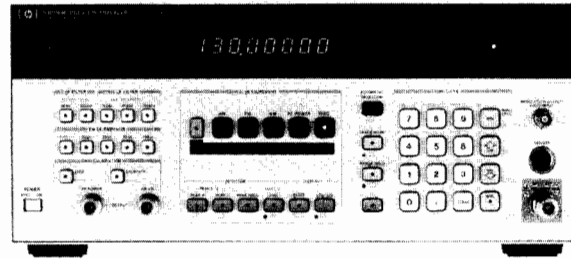

HP 8901B



#### Accuracy:

±2% of reading ±1 digit, 20 Hz to 10 kHz rates, 250 kHz to 10 MHz.  
 ±1% of reading ±1 digit, 50 Hz to 100 kHz rates, 10 MHz to 1300 MHz.

**Demodulated output distortion:** <0.1% THD.

**AM rejection (for 50% AM at 400 Hz and 1 kHz rates):** <20 Hz peak deviation measured in a 50 Hz to 3 kHz BW.

**Residual FM (50 Hz to 3 kHz BW):** <8 Hz rms @ 1300 MHz, decreasing linearly with frequency to <1 Hz rms for 100 MHz and below.

**Maximum deviation resolution:** 1 Hz.

**Stereo separation (50 Hz to 15 kHz):** >47 dB typical.

#### Phase Modulation

**Carrier frequency:** 10 MHz to 1300 MHz.

**Rates:** 200 Hz to 20 kHz; typically usable from 20 Hz to 100 kHz with degraded performance.

**Deviation:** to 400 radians.

**Maximum deviation resolution:** 0.001 radian.

**Accuracy:** ±3% of reading ±1 digit.

**Demodulated output distortion:** <0.1% THD.

**AM rejection (for 50% AM at 1 kHz rate):** <0.03 radian peak deviation (50 Hz to 3 kHz BW).

#### Amplitude Modulation

**Rates:** 20 Hz to 100 kHz.

**Depth:** to 99%.

**Accuracy:**

±2% of reading ±1 digit, 50 Hz to 10 kHz rates, 150 kHz to 10 MHz.  
 ±1% of reading ±1 digit, 50 Hz to 50 kHz rates, 10 MHz to 1300 MHz.

**Flatness (variation in indicated AM depth for constant depth on input signal):** ±0.3% of reading ±1 digit.

**Demodulated output distortion:** <0.3% THD.

**FM rejection (at 400 Hz and 1 kHz rates, 50 Hz to 3 kHz BW):** <0.2% AM.

**Residual AM (50 Hz to 3 kHz BW):** <0.01% rms.

**Maximum depth resolution:** 0.01%.

#### Frequency Counter

**Range:** 150 kHz to 1300 MHz.

**Accuracy:** ±3 counts of least significant digit ± reference accuracy.

**Internal reference:**

**Frequency:** 10 MHz.

**Aging rate:** <1x10<sup>-6</sup>/month (optional: 1x10<sup>-9</sup>/day).

**Maximum resolution:**

**HP 8901A:** 10 Hz for frequencies <1 GHz; 100 Hz for frequencies ≥1 GHz.

**HP 8901B:** 1 Hz.

#### HP 8901A RF Level (Peak Voltage Responding, RMS Sine Wave Power Calibrated)

**Range:** 1 mW to 1W.

**Instrumentation accuracy:** ±3 dB; 1.5 dB typical.

**SWR:** ≤1.3, 150 kHz to 650 MHz; ≤1.5, 650 MHz to 1300 MHz.

**Maximum resolution:** 0.001 mW for levels <0.01W.

# SIGNAL ANALYZERS

## Modulation Analyzer, 150 kHz to 1300 MHz AM/FM Test Source (cont'd)

### HP 8901A, 8901B, 11715A

#### HP 8901B RF Level (True RMS)

Frequency range with HP 11722A: 100 kHz to 2.6 GHz.

Power range: -20 dBm to +30 dBm.

#### RF range-to-range change error:

±0.02 dB/RF range change from reference range.

Input SWR: <1.15, using HP 11722A Sensor Module.

#### Zero set (digital settability of zero):

±0.5% ±1 digit of full scale on lowest range.

Decrease by a factor of 10 for each high range.

#### RF power resolution:

0.1% of full scale in watts or volts mode.

0.001 in dBm or dB relative mode.

### HP 8901B Selective Power Measurements (Options 030-037)

Frequency range: 10 MHz to 1.3 GHz.

Carrier power range: +30 dBm to -20 dBm, 12.5, 25 and 30 kHz filters; +30 dBm to -10 dBm, Carrier Noise Filter.

Dynamic range: 115 dB.

Carrier rejection (temp. ≤35° C): >90 dB, for offsets ≥1 channel spacing or 5 kHz, whichever is larger.

Relative accuracy: ±0.5 dB, levels ≥-95 dBc or levels ≥-129 dBc/Hz.

#### Power Reference

Power output: 1.00 mW. Factory set to ±0.7%, traceable to the U.S. National Bureau of Standards.

Accuracy: ±1.2% worst case (±0.9% rss) for one year (0° C to 55° C).

#### Audio Filters

High pass (3 dB cutoff frequency): 50 Hz and 300 Hz

Low pass (3 dB cutoff frequency except >20 kHz filter): 3 kHz, 15 kHz, >20 kHz.

De-emphasis filters: 25 μs, 50 μs, 75 μs, and 750 μs.

### Calibrators (Standard HP 8901B, Option 010 HP 8901A)

AM calibrator depth and accuracy: 33.33% depth, nominal; internally calibrated to an accuracy of ±0.1%.

FM calibrator deviation and accuracy: 34 kHz peak deviation, nominal; internally calibrated to an accuracy of ±0.1%.

#### General Characteristics

Operating temperature range: 0° to 55° C.

Power requirements: 100, 120, 220, or 240V (+5%, -10%); 48-66 Hz; 200 VA max.

Weight: HP 8901A—net 20 kg (44 lb), shipping 25 kg (55 lb);

HP 8901B—net 23 kg (52 lb), shipping 31 kg (69 lb).

Size: HP 8901A, 190 mm H x 425 mm W x 468 mm D (7.5 in. x 16.8 in. x 18.4 in.); HP 8901B, 190 mm H x 425 mm W x 551 mm D (7.5 in. x 16.8 in. x 21.7 in.)

#### Ordering Information

HP 8901A Modulation Analyzer <sup>1</sup>	\$10,400
Opt 001 RF connectors on rear panel only	+\$240
Opt 002 1x10 <sup>-9</sup> /day internal reference	+\$825
Opt 003 Connections for external local oscillator	+\$450
Opt 004 Operation from 48 to 440 Hz power (Temp. <40° C)	+\$310
Opt 010 AM and FM calibrators	+\$685
Opt 910 A total of 2 sets of operating (08901-90135) and service manuals (08901-90136)	+\$255 ☎
Opt 915 Service manual (08901-90136)	+\$103 ☎
Opt W30 Extended repair service. See page 723.	+\$235
Opt W32 Calibration service. See page 723.	+\$840
HP 8901B Modulation Analyzer <sup>1</sup>	\$14,650
Opt 001 RF connectors on rear panel only	+\$240
Opt 002 1x10 <sup>-9</sup> /day internal reference	+\$825
Opt 003 Connections for external local oscillator	+\$450
Opt 004 Operation from 48 to 440 Hz power (Temp. <40° C)	+\$310
Opt 021 Add HP 11722A Sensor Module	+\$2,260
Opt 030 High selectivity (select only 2 filter options) (Options 032-037 require Option 030; Option 030 includes Option 003 connections for external local oscillators.)	+\$2,680
Opt 032 12.5 kHz filter	\$0
Opt 033 20.0/25.0 kHz filter	\$0
Opt 035 Cellular Radio Filter	\$0
Opt 037 Carrier Noise Filter	\$0

<sup>1</sup>HP-IB cables not included. For description and prices, see page 579

Opt 910 2 sets of operation/calibration (08901-90113) and service manuals (08901-90114)	+\$370 ☎
Opt 915 Service manual (08901-90114)	+\$155 ☎
Opt W30 Extended repair service. See page 723	+\$335
Opt W32 Calibration service. See page 723	+700

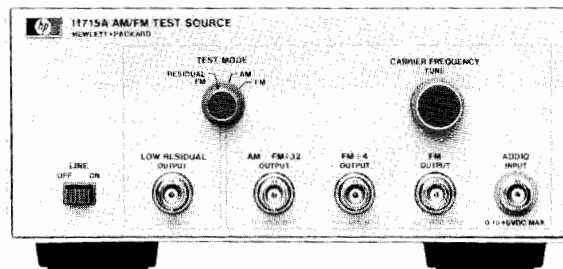

### HP 11715A

#### HP 11715A AM/FM Test Source

The HP 11715A AM/FM Test Source provides very flat, wide-bandwidth, and low distortion amplitude or frequency modulated RF signals. Designed primarily for performance tests and adjustments of the HP 8901A/B Modulation Analyzer and HP 8902A Measuring Receiver, it will also serve as a high quality modulated test oscillator where its frequency ranges apply.

The major components of the HP 11715A are a low-noise voltage controlled oscillator (VCO), two digital dividers, and a double-balanced mixer. The VCO is the primary signal source, with a typical frequency range of 330 to 470 MHz at the FM OUTPUT. FM is produced by directly coupling the external modulation source to the VCO's tune input, providing very wide bandwidth modulation with low phase shift. This design also ensures very little incidental AM.

The HP 11715A can also be used in conjunction with an HP 8901A/B and an HP 8902A as a calibrated signal source for special applications. In particular, the U.S. commercial FM broadcast band of 88 to 108 MHz is covered by the FM ÷ 4 OUTPUT of the HP 11715A.

#### HP 11715A Specifications

##### FM Outputs

###### Frequency range:

11 to 13.5 MHz, AM FM ÷ 32 output.

88 to 108 MHz, FM ÷ 4 output.

352 to 432 MHz, FM output.

###### Peak deviation:

>12.5 kHz, 11 to 13.15 MHz carrier.

>100 kHz, 88 to 108 MHz carrier.

>400 kHz, 352 to 432 MHz carrier.

###### Distortion:

<0.025% THD (<-72 dB) for

Carrier frequency	Peak deviation	Modulation rate
12.5 MHz	12.5 kHz	<10 kHz
100 MHz	100 kHz	<100 kHz
400 MHz	400 kHz	<100 kHz

##### Flatness:

±0.1%, dc to 100 kHz rates.

±0.25%, dc to 200 kHz rates.

**Stereo separation (88 to 108 MHz carrier, 75 kHz peak deviation, 1 kHz rate):** >60 dB typical.

##### AM Output

**Frequency range (AM FM ÷ 32 output):** 11 to 13.5 MHz.

**Depth:** to 99%.

##### Distortion:

<0.05% THD (<-66 dB), 50% AM, 20 Hz to 100 kHz rates.

<0.1% THD (<-60 dB), 95% AM, 20 Hz to 100 kHz rates.

**Flatness:** ±0.1%, 50 Hz to 50 kHz rates;

±0.25%, 20 Hz to 100 kHz rates.

**Linearity:** ±0.1%, <95% AM; ±0.2%, <99%.

#### Ordering Information

HP 11715A AM/FM Test Source	Price \$2,730
Opt 910 A total of 2 sets of operating and service manuals (11715-90004)	+\$25 ☎

☎ For same-day shipment, call HP DIRECT at 800-538-8787

- RF power: digital power meter accuracy
- Tuned RF level: 0 dBm to -127 dBm dynamic range
- Carrier Noise: AM and phase noise measurements to -140 dBc/Hz

- AM and FM, 1% accuracy;  $\emptyset$ M, 3% accuracy
- RF frequency: 1 Hz resolution
- Audio: frequency, level and distortion

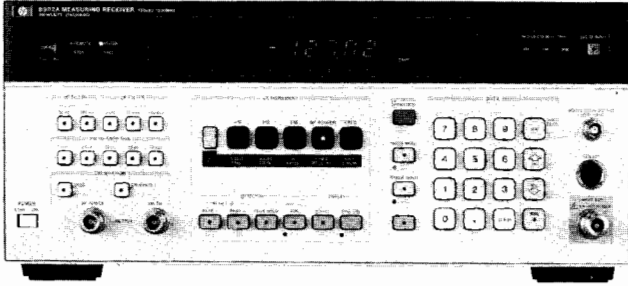

HP 8902A 

### HP 8902A Measuring Receiver

The HP 8902A Measuring Receiver combines six precise measurement functions into one fully automatic, HP-IB programmable instrument. It accurately measures RF power, tuned RF level, carrier noise/adjacent channel power, modulation and RF frequency, and characterizes audio signals. For precise signal analysis, the HP 8902A Measuring Receiver provides the performance you need.

### Metrology and Calibration

The HP 8902A Measuring Receiver makes signal generator and attenuator calibration easier than ever before. As the main component in the HP 8902AT Attenuator Calibration System and the HP 8902SG Signal Generator Test System, the HP 8902A provides exceptional accuracy, wide dynamic range and a broad range of measurements.

The HP 8902A quickly and accurately measures your signal generator's RF frequency, RF level flatness, output level accuracy to -127 dBm, AM and FM with 1% accuracy, incidental and residual AM, FM and phase modulation, carrier noise down to -140 dBc/Hz and characterizes the demodulated audio signals.

For attenuator calibration and other relative measurements, the HP 8902A gives you the accuracy and dynamic range you need. Option 050 gives  $\pm(0.015 \text{ dB} + 0.005 \text{ dB}/10 \text{ dB})$  relative power accuracy to test attenuators to the most stringent specifications.

### RF Signal Characterization

The HP 8902A Measuring Receiver is an excellent lab and production tool for accurately characterizing RF signals from 150 kHz to 1300 MHz.

Level measurements down to -127 dBm with superb accuracy make the HP 8902A ideal for testing devices such as antennas, multiplexers, log/linear amplifiers, filters and mixers. Unlike diode detectors, the HP 8902A's power meter accurately measures signals with harmonics and spurious.

The HP 8902A makes accurate AM to  $\emptyset$ M and FM to AM conversion measurements of phase and amplitude sensitive devices such as bandpass filters and multiple channel receivers. Excellent isolation between AM and FM makes it simple to separate the AM and  $\emptyset$ M of AM stereo, incidental AM of FM transmitters and the AM, FM and  $\emptyset$ M components of complex signals.

### Automatic Test Systems

The HP 8902A is an important component of automatic RF test systems. All functions — power, level, frequency count, carrier noise, modulation, audio analysis — are fully automatic and easily programmed. With these measurements combined into one instrument, interfacing requirements, hardware costs, and software development time are reduced.

### HP 8902A Specifications

#### RF Power (with HP 11722A Sensor Module)

**Range:** +30 dBm (1W) to -20 dBm (10  $\mu$ W).

**Frequency range:** 0.1 MHz to 2.6 GHz.

**Linearity:**  $\pm 0.02 \text{ dB}$  (within range)  $\pm 0.02 \text{ dB}$  per range change from reference range  $\pm 1$  count LSD.

**Input SWR:** <1.15.

#### Tuned RF Level

**Range:** 0 dBm to -127 dBm.

**Frequency range:** 2.5 MHz to 1300 MHz.

**Relative accuracy:**  $\pm 0.02 \text{ dB} \pm 0.02 \text{ dB}$  per IF range change  $\pm 0.04 \text{ dB}$  per RF range change  $\pm 1$  digit.

**Worst case cumulative relative power accuracy (with Opt 050)<sup>1,2</sup>:**

$\pm 0.005 \text{ dB}/10 \text{ dB}$  step (0 to -100 dBm).

$\pm 0.050 \text{ dB}/10 \text{ dB}$  step (-100 to -120 dBm).

$\pm 0.015 \text{ dB} \pm 1$  digit.

#### Selective Power Measurements (Carrier Noise, Options 030-037)

**Frequency range:** 10 MHz to 1300 MHz.

**Carrier power range:**

+30 dBm to -20 dBm; 12.5 kHz, 25 kHz and 30 kHz filters.

+30 dBm to -10 dBm; Carrier Noise filter.

**Relative measurement accuracy:**

$\pm 0.5 \text{ dB}$ ; levels > -95 dBc; 12.5 kHz, 25 kHz and 30 kHz filters.

$\pm 0.5 \text{ dB}$ ; levels > -129 dBc/Hz; Carrier Noise filter.

**Filter bandwidths:** 2.5 kHz, Carrier Noise filter; 8.0 kHz, 12.5 kHz filter; 16.0 kHz, 25 kHz filter; 30.0 kHz, Cellular Radio filter.

#### RF Frequency

**Range:** 150 kHz to 1300 MHz.

**Maximum resolution:** 1 Hz.

#### Amplitude Modulation

**Rates:** 20 Hz to 100 kHz.

**Depths:** to 99%.

**Accuracy:**  $\pm 1\%$  of reading  $\pm 1$  digit, for rates 50 Hz to 50 kHz and depths  $\geq 5\%$ .

#### Frequency Modulation

**Rates:** 20 Hz to 200 kHz.

**Deviations:** to 400 kHz.

**Accuracy:**  $\pm 1\%$  of reading  $\pm 1$  digit, for rates 50 Hz to 100 kHz.

#### Phase Modulation

**Rates:** 200 Hz to 20 kHz.

**Deviations:** to 400 radians.

**Accuracy:**  $\pm 3\%$  of reading  $\pm 1$  digit.

#### Audio Level, Frequency and Distortion Capability

##### Audio Level

**Accuracy:**  $\pm 4\%$  of reading, 100 mV to 3V.

##### Audio Frequency

**Display resolution:** 6 digits, to 250 kHz.

##### Audio Distortion

**Accuracy:**  $\pm 1 \text{ dB}$ , 400 Hz and 1 kHz.

<sup>1</sup>Specifications are warranted when using a Hewlett-Packard synthesized source with less than 100 Hz peak residual FM measured in a 3 kHz post detection bandwidth over a 30-second period.

<sup>2</sup>Accuracy specifications do not include mismatch uncertainty.

# SIGNAL ANALYZERS

## Measuring Receiver, Sensor Module, Verification Kit

HP 8902A, 11722A, 11812A

### Ordering Information

HP 8902A Measuring Receiver <sup>1</sup>	\$26,350
Opt 001 Rear panel instead of front panel connections for input, modulation output, and calibrators	+\$240
Opt 002 $1 \times 10^{-9}$ /day internal reference oscillator	+\$825
Opt 003 RF connectors on rear panel only	+\$450
Opt 004 Operation from 48 Hz to 400 Hz power line (temp. <40°C)	+\$310
Opt 021 Add HP 11722A Sensor Module	+\$2,260
Opt 030 High selectivity (select only two filter options)	+\$2,680
(Options 032-037 require Option 030. Option 030 includes Option 003 connections for external local oscillator.)	
Opt 032 12.5 kHz Filter	\$0
Opt 033 25.0 kHz Filter	\$0
Opt 035 Cellular Radio Filter	\$0
Opt 037 Carrier Noise Filter	\$0
Opt 050 Increased power measurement accuracy	+ \$3,785
Opt 907 Front handle kit (5061-9690)	+ \$67
Opt 908 Rack flange kit (5061-9678)	+ \$36
Opt 909 Rack flange kit (5061-9684) with front handles	+ \$93
Opt 910 Provides an additional operation and calibration manual (08902-90029) and two service manuals (08902-90031)	+ \$370
Opt 915 Add service manual (08902-90031)	+ \$155
Opt W30 Extended repair service, see page 723	\$380
Opt W32 Calibration service	\$735

☎ For same-day shipments, call HP DIRECT at 800-538-8787

### Price

\$26,350

+\$240

+\$825

+\$450

+\$310

+\$2,260

+\$2,680

\$0

\$0

\$0

\$0

+ \$3,785

+ \$67

+ \$36

+ \$93

+ \$370

+ \$155

\$380

\$735

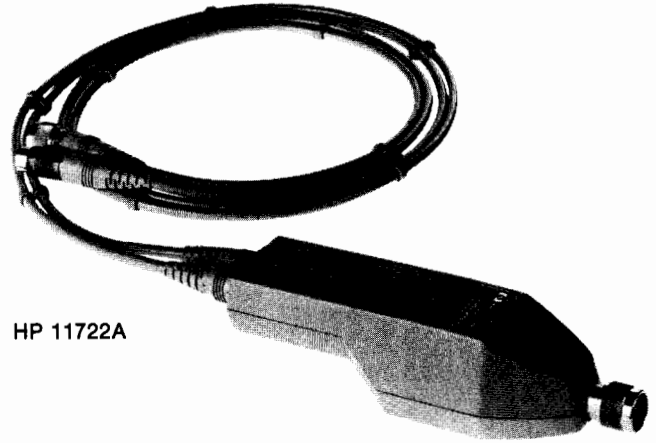

HP 11722A

### HP 11722A Sensor Module

The HP 11722A Sensor Module was designed for use with the HP 8901B Modulation Analyzer and HP 8902A Measuring Receiver. The HP 11722A contains a silicon monolithic thermocouple as a power sensing element.

With the HP 11722A Sensor Module, you get all the performance of the HP 8901B or HP 8902A, plus superb power measurement accuracy, at a single connector. You can characterize a signal without switching back and forth between the power sensor and the analyzer's RF input.

Each HP 11722A Sensor Module is individually calibrated, traceable to the U.S. National Bureau of Standards. The calibration factors are printed on the sensor module for easy reference. Enter these factors into the HP 8901B or HP 8902A's non-volatile memory and the instrument automatically compensates for the power sensor's efficiency and mismatch loss at each frequency.

### HP 11722A Specifications

**Frequency range:** 100 kHz to 2.6 GHz.

**Power range:** +30 dBm (1 watt) to -20 dBm (10  $\mu$ W).

**Input SWR (connected to an HP 8901B or 8902A):** <1.15, for RF power measurements.

**Power sensor linearity:** +2%, -4%; +30 dBm to +20 dBm. Negligible deviation, levels <+20 dBm.

**Calibration factors:** Each HP 11722A Sensor Module is individually calibrated. The calibration factors are printed on the HP 11722A Sensor Module for easy reference.

### Cal Factor Uncertainty

Frequency	RSS Uncertainty	Worst Case Uncertainty
0.1 MHz	0.7%	1.6%
0.3 MHz	0.7%	1.6%
1.0 MHz	0.8%	1.7%
3.0 MHz	0.8%	1.7%
10.0 MHz	0.9%	2.0%
30.0 MHz	0.9%	2.0%
50.0 MHz	0.0% (ref.)	0.0% (ref.)
100.0 MHz	1.1%	2.2%
300.0 MHz	1.1%	2.2%
1000.0 MHz	1.1%	2.2%
2600.0 MHz	1.2%	2.3%



### HP 11812A Verification Kit

The HP 11812A Verification Kit is available to verify the performance of the HP 8902A Option 050 tuned RF level function to  $\pm(0.015 \text{ dB} + 0.010 \text{ dB}/10 \text{ dB step})$ . The kit consists of a step attenuator, two 10 dB pads semi-permanently attached, a cable, and a case.

### HP 11812A Specifications

**Frequency:** 30 MHz.

**HP 11812A accuracy:**  $\pm(0.003 \text{ dB} + 0.003 \text{ dB}/10 \text{ dB step})$ .

**Option 050 worst case cumulative tuned RF level accuracy verified with the HP 11812A:**

$\pm 0.010 \text{ dB}/10 \text{ dB step}$  (0 to -100 dBm)

$\pm 0.050 \text{ dB}/10 \text{ dB step}$  (-100 to -120 dBm)

$\pm 0.015 \text{ dB} \pm 1 \text{ digit}$ .

### Ordering Information

HP 11812A Verification Kit

<sup>1</sup>HP-IB cables not included. For description and prices, see page 579

### Price

\$2,110

### Ordering Information

HP 11722A Sensor Module

Opt 910 Additional operating and service manual

☎ For same-day shipments, call HP DIRECT at 800-538-8787

### Price

\$2,260

+ \$10

# SIGNAL ANALYZERS

## Attenuator Calibration System

HP 8902AT, 11806B, 11823A/B/C

213

- Exceptional accuracy:  $\pm 0.015$  dB  $\pm 0.005$  dB/10 dB
- 100 dB dynamic range
- Tests fixed, manual, and programmable attenuators
- 10 MHz to 26.5 GHz

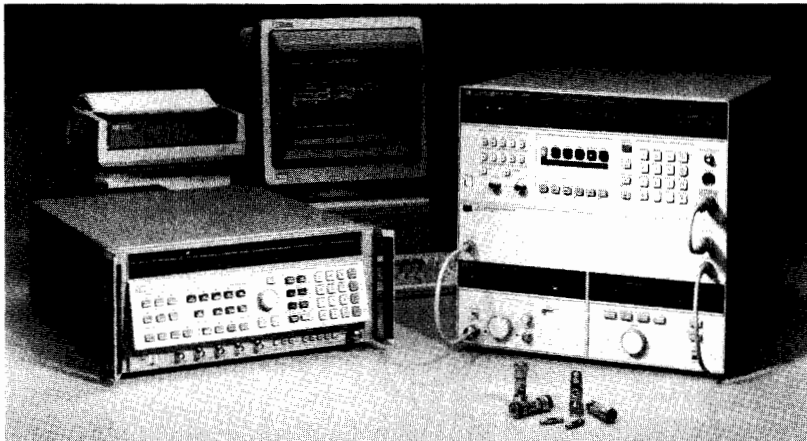

HP 8902AT

### HP 8902AT Attenuator Calibration System

The HP 8902AT offers the total solution for attenuator calibration. It is configured for optimal performance from 10 MHz to 18 GHz. Option 026 extends the superb performance to 26.5 GHz. The HP 8902AT combines the exceptional accuracy of the HP 8902A Option 050 with the HP 11806B Attenuator Test Software to give you precise results with the speed of automation.

The HP 8902AT minimizes measurement uncertainty by specifying 0.005 dB/10 dB attenuation accuracy, monitoring the output power of the attenuator source, and automatically adjusting for any amplitude instabilities. This provides you with state-of-the-art accuracy, simply and repeatably.

The HP 8902AT includes the HP 11806B Attenuator Test Software, HP 8902A Option 050 Measuring Receiver, HP 11793A Microwave Converter, local oscillator, attenuator source, power splitter, power sensor, attenuator accessory kit, and SWR accessory kit. For a detailed list of equipment see the HP 8902S Ordering Guide.

### Accessory Kits

The HP 8902AT Attenuator Calibration System includes an attenuator accessory kit and an SWR accessory kit. The HP 11823A/B Attenuator Accessory Kit includes 10 dB matching attenuators and adapters to test attenuators with Type-N, APC-3.5, and APC-7 connectors. The HP 11823C SWR Accessory Kit includes precision SWR bridges, opens, shorts, and terminations.

### HP 11806B Attenuator Test Software

The HP 11806B provides the efficiency and repeatability of automation for attenuator calibration. By entering a table of frequencies, levels and specification limits, you can test any RF or microwave attenuator - fixed, manual or programmable - quickly and accurately.

The HP 11806B offers flexibility and ease of use with user-selectable averaging, various output formats, and flexible hardware configurations. With additional features such as statistical analysis, multiple test frequencies, and supporting multiple attenuator sources the HP 11806B is the ideal software pac for all your attenuator calibration needs.

### HP 8902AT Specifications

#### Frequency Range:

10 MHz to 18 GHz,  
10 MHz to 26.5 GHz, Option 026.

#### Dynamic Range:

+10 dBm to -117 dBm, 10 MHz to 1300 MHz,  
0 dBm to -100 dBm, 1300 MHz to 18 GHz,  
0 dBm to -95 dBm, 18 GHz to 26.5 GHz.

#### Attenuation Accuracy:<sup>1</sup>

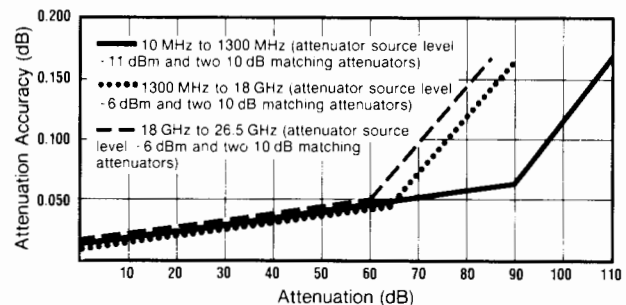

For optimal dynamic range the attenuator source level can be increased to -11 dBm and smaller matching attenuators can be used. This results in an additional 0.1 dB uncertainty for frequencies 1300 MHz to 26.5 GHz.

### Ordering Information

HP 8902AT Attenuator Calibration System  
Opt 026 26.5 GHz coverage

### Price

\$127,850  
+\$47,555

HP 11806B Attenuator Test Software

\$3,190

HP 11823A Attenuator Accessory Kit

\$5,660

HP 11823B Attenuator Accessory Kit

\$6,690

HP 11823C SWR Accessory Kit

\$20,100

<sup>1</sup>Accuracy specifications do not include mismatch uncertainty.

# SIGNAL ANALYZERS

## Signal Generator Test System

HP 8902SG, 11808A

- Frequency coverage to 26.5 GHz
- Powerful software offers simple test modifications

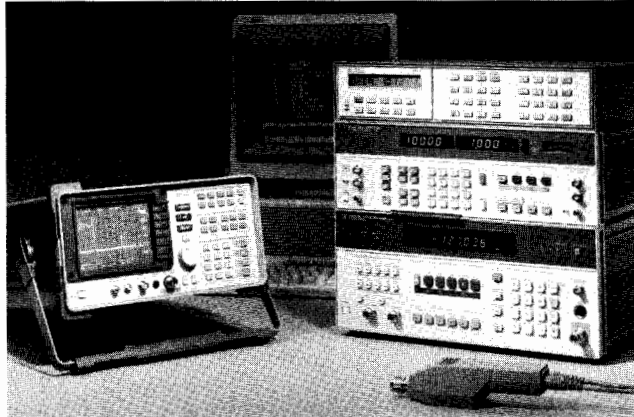

HP 8902SG

### HP 8902SG Signal Generator Test System

The HP 8902SG Signal Generator Test System provides a versatile and powerful solution for testing RF and microwave signal generators. System hardware provides accurate measurements and complete automation; the dedicated software adds flexibility, speed, and ease-of-use.

The standard system includes an HP 8902A Measuring Receiver, HP 8903B Audio Analyzer, HP 8562B Spectrum Analyzer, and HP 3488A Switch Control Unit to provide complete automation. The HP 11808A Signal Generator Performance Test Software is included, as are all cables and adapters required to complete the system. Options 018 and 026 add the HP 11793A Microwave Converter and a synthesized local oscillator to extend measurement capabilities to microwave frequencies.

Many common signal generator performance tests can be run with the HP 8902SG. Tests such as Output Level Accuracy, Output Flatness, AM and FM Accuracy are but a few of those available. The system can be expanded to offer additional tests such as Pulse Rise/Fall time and third order intermodulation distortion. The system software is easily updated to reflect changes in the test equipment used.

### HP 8902SG Specifications

#### RF Frequency

**Range:** 150 kHz to 1300 MHz, standard system.  
150 kHz to 18 GHz, Opt 018.  
150 kHz to 26.5 GHz, Opt 026.

#### RF Power

**Range:** +30 dBm to -20 dBm, standard system.  
+30 dBm to -20 dBm, Options 018 and 026.

**Frequency range:** 100 kHz to 2600 MHz, standard system,  
50 MHz to 18 GHz, Option 018,  
50 MHz to 26.5 GHz, Option 026.

#### Tuned RF Level

**Frequency range:** 2.5 MHz to 1300 MHz, standard system,  
2.5 MHz to 18 GHz, Option 018,  
2.5 MHz to 26.5 GHz, Option 026.

**Range:** +10 dBm to -117 dBm, 2.5 MHz to 1300 MHz,  
0 dBm to -100 dBm, 1300 MHz to 18 GHz (Options 018 & 026),  
0 dBm to -95 dBm, 18 GHz to 26.5 GHz, (Option 026).

**Relative accuracy:**  $\pm 0.02$  dB  $\pm 0.02$  dB per IF range change  $\pm 0.04$  dB per RF range change  $\pm 1$  digit.

- Fully automated system: more thorough testing in less time
- Fast, accurate, and repeatable measurements

#### Amplitude Modulation

**Rates:** 20 Hz to 100 kHz.

**Depths:** to 99%.

**Accuracy:**  $\pm 1\%$  of reading  $\pm 1$  digit, for rates 50 Hz to 50 kHz and depths  $\geq 5\%$ .

#### Frequency Modulation

**Rates:** 20 Hz to 200 kHz.

**Deviations:** to 400 kHz.

**Accuracy:**  $\pm 1\%$  of reading  $\pm 1$  digit, rates 50 Hz to 100 kHz.

#### Phase Modulation

**Rates:** 200 Hz to 20 kHz.

**Deviations:** to 400 radians.

**Accuracy:**  $\pm 3\%$  of reading  $\pm 1$  digit.

#### Audio Source

**Frequency range:** 20 Hz to 100 kHz.

**Frequency accuracy:** 0.3% of setting.

#### Audio Analyzer

**Distortion frequency range:** 20 Hz to 100 kHz fundamentals.

**Distortion accuracy:**  $\pm 1$  dB, 20 Hz to 20 kHz.

#### General

**Temperature:** Operating, 0°C to 55°C; Storage, -25°C to 75°C.

**Power:** 100, 120, 220, or 240V (+5%, -10%); 48-66 Hz.

### HP 11808A Signal Generator Performance Test Software

The HP 11808A software provides 29 common performance tests for RF and microwave signal generators. The software is structured so tests are defined by data files; data files for HP signal generators are included with the software - others can be created easily through simple screen entries.

The software supports the equipment in the HP 8902SG configurations, as well as other types such as digital scopes, digital voltmeters, and function generators. Instruments in the system can be indicated quickly in the program through the use of soft-keys and the configuration can be stored for later use.

#### Ordering Information

	Price
HP 8902SG Signal Generator Test System	\$83,000
Opt 018 Extension to 18 GHz operation	+\$39,800
Opt 026 Extension to 26.5 GHz operation	+\$64,200
HP 11808A Signal Generator Performance Test Software	\$5,700

# SIGNAL ANALYZERS

150 kHz to 26.5 GHz

HP 8902S, 11792A, 11793A, 11794A

215

- RF power: digital power meter accuracy
- Tuned RF level: 0 dBm to -100 dBm dynamic range
- AM and FM: 1% accuracy,  $\Phi$ M: 3% accuracy

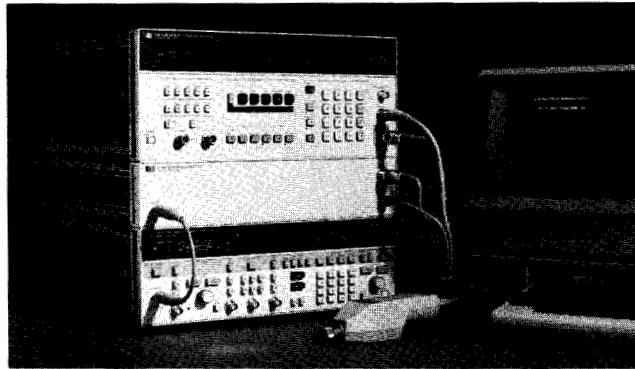

HP 8902S

## HP 8902S Measurement System

The HP 8902S Measurement System extends the superb measurement performance of the HP 8902A Measuring Receiver to microwave frequencies. The frequency is extended by adding an HP 11793A Microwave Converter and a local oscillator. With the HP 11792A Sensor Module the system delivers the accuracy and resolution of a high performance power meter to 26.5 GHz from +30 dBm to -100 dBm. It accurately measures AM, FM, and  $\Phi$ M (including residuals and incidentals) with a single keystroke. Adding options 030-037 to the HP 8902A extends the system's capability to include carrier noise measurements. The HP 8902S counts signals to 26.5 GHz with 10 Hz resolution and excellent long-term frequency stability.

The HP 8902S provides flexibility in specifying a solution that meets your exact needs. It can be configured for attenuator calibration, signal generator performance testing, and general signal characterization. For dedicated, preconfigured systems the HP 8902AT Attenuator Calibration System and the HP 8902SG Signal Generator Test System are available.

### System Software

Under the control of the HP 11794A Software Pac, the HP 8902S Measurement System functions as a single instrument. You select the frequency and measurement from the front panel of the HP 8902A. The software then calculates and sets the local oscillator frequency, then releases the HP 8902A to make the measurement and display the results.

For a fully automated system the HP 8902S is supported by the HP 11806B Attenuator Test Software and HP 11808A Signal Generator Performance Test Software.

### HP 11793A Microwave Converter

The HP 11793A Microwave Converter down converts microwave signals to the frequency range of the HP 8902A Measuring Receiver. For signals above 1.3 GHz, the HP 11793A routes the signal through its internal mixer. Below 1.3 GHz, signals are routed directly to the input of the HP 8902A.

The HP 11793A requires +8 dBm leveled output from the local oscillator. For LOs with insufficient power above 18 GHz, the HP 11793A offers an optional 18 to 26.5 GHz amplifier.

### HP 11792A Sensor Module (50 MHz to 26.5 GHz)

The HP 11792A Sensor Module gives you all the performance of the HP 8902S system, plus superb power measurement accuracy, at a single connector. You can characterize a signal without manually switching between the power sensor and the receiver input.

Each HP 11792A Sensor Module is individually calibrated, traceable to the U.S. National Bureau of Standards. The calibration factors are printed on the sensor module for easy reference. Enter these factors into the HP 8902A's non-volatile memory and the instrument automatically compensates for the power sensor's efficiency and mismatch loss at each frequency.

- Carrier Noise (AM and phase noise measurements):  $\pm 0.5$  dB accuracy
- RF frequency: 10 Hz resolution
- Audio: frequency, level and distortion

## HP 8902S Specifications

### RF Power (with HP 11792A Sensor Module)

**Range:** +30 dBm (1W) to -20 dBm (10  $\mu$ W).

**Frequency range:** 50 MHz to 26.5 GHz.

**Linearity:**  $\pm 0.02$  dB (within range)  $\pm 0.02$  dB per range change from reference range  $\pm 1$  digit.

**Input SWR:** <1.10,  $f_c \leq 2.0$  GHz.

<1.28, 2.0 GHz <  $f_c \leq 18$  GHz.

<1.40, 18.0 GHz <  $f_c \leq 26.5$  GHz.

### Tuned RF Level<sup>1</sup>

**Frequency range<sup>2</sup>:** 2.5 MHz to 26.5 GHz.

**Dynamic range:**

+10 dBm to -117 dBm, 2.5 MHz  $\leq f_c \leq 1300$  MHz.

0 dBm to -100 dBm, 1300 MHz <  $f_c \leq 18.0$  GHz.

0 dBm to -95 dBm, 18.0 GHz <  $f_c \leq 26.5$  GHz.

**Relative accuracy:**  $\pm 0.02$  dB  $\pm 0.02$  dB per IF range change  $\pm 0.04$  dB per RF range change  $\pm 1$  digit.

### RF Frequency

**Range<sup>2</sup>:** 150 kHz to 26.5 GHz.

**Maximum resolution:** 10 Hz.

**Time base aging rate:**  $< 5 \times 10^{-10}$ /day, for HP 8672A, HP 8673B/D/E;  $< 1 \times 10^{-9}$ /day, for HP 8340B, HP 8341B.

### Amplitude Modulation

**Frequency range<sup>2</sup>:** 150 kHz to 26.5 GHz.

**Rates:** 20 Hz to 100 kHz.

**Depths:** to 99%.

**Accuracy:**  $\pm 1\%$  of reading  $\pm 1$  digit, for rates 50 Hz to 50 kHz and depths  $\geq 5\%$ .

### Frequency Modulation

**Frequency range<sup>2</sup>:** 150 kHz to 26.5 GHz.

**Rates:** 20 Hz to 200 kHz.

**Deviations:** to 400 kHz.

**Accuracy:**  $\pm 1\%$  of reading  $\pm 1$  digit, for rates 50 Hz to 100 kHz.

### Phase Modulation

**Frequency range<sup>2</sup>:** 150 kHz to 26.5 GHz.

**Rates:** 200 Hz to 20 kHz.

**Deviations:** to 400 radians.

**Accuracy:**  $\pm 3\%$  of reading  $\pm 1$  digit.

### General

**Temperature:** Operating, 15° C to 35° C; storage, -25° C to 60° C.

**Power:** 100, 120, 220, or 240V (+5%, -10%); 48-66 Hz; 1300 VA maximum (worst case).

**Weight:** Net 122.3 kg (270 lb); shipping, 153.3 kg (338.3 lb) worst case.

### Ordering Information

**HP 8902S Measurement System**

For complete ordering information, see the "HP 8902S Measurement System Ordering Information" guide, or call your HP sales office.

**HP 11794A Software Pac**

\$255

<sup>1</sup>An HP 11722A Sensor Module may be used with the HP 8902S to make tuned RF level measurements from 2.5 MHz to 1300 MHz at levels from 0 dBm to -127 dBm.

<sup>2</sup>Frequency range may be limited by the frequency range of the LO.

# NETWORK ANALYZERS

## Complete Characterization of Linear Networks

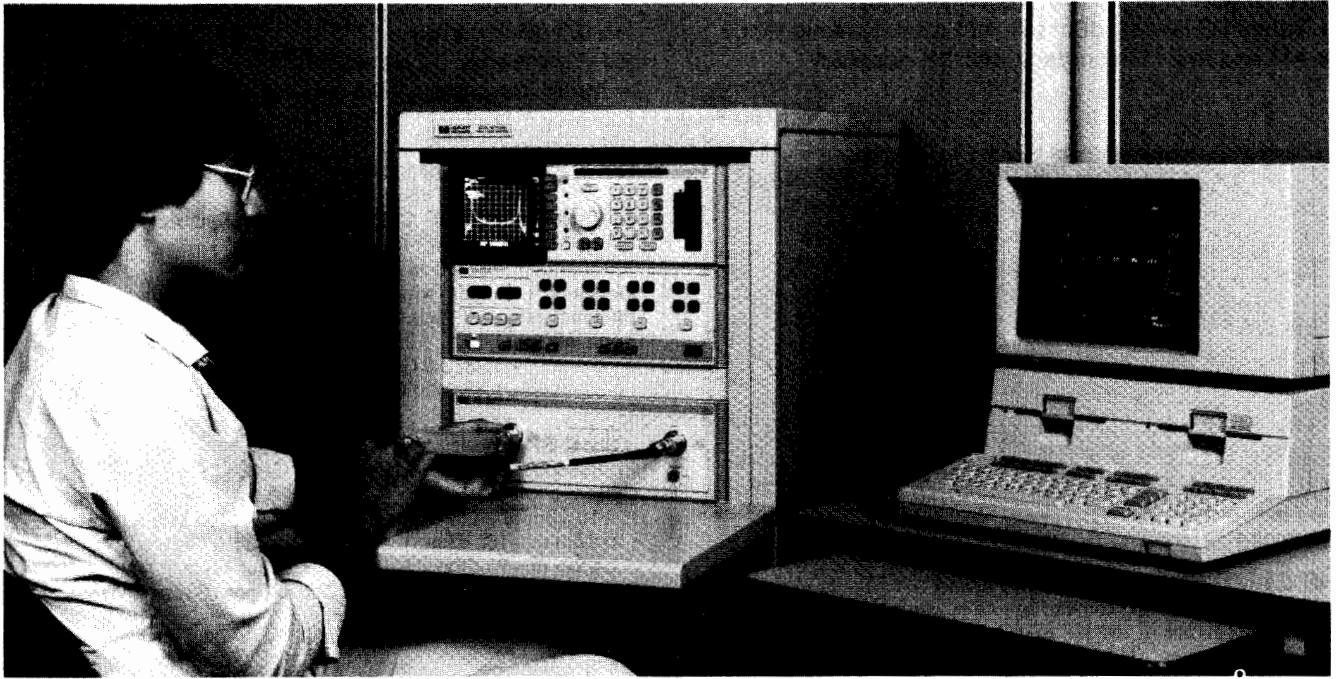

### Why Network Analysis?

Characterizing the behavior of linear networks that will be stimulated by arbitrary signals and interfaced with a variety of other networks is a fundamental problem in both synthesis and test processes. For example, the engineer designing a multi-component network must predict with some certainty the final network performances from knowledge of the individual components. Similarly, a production manager must know allowable tolerances on the products manufactured and whether the final products meet the specified tolerances. Network analysis offers a solution to these problems through complete description of linear network behavior in the frequency domain. Additionally, some network analyzers offer the capability to transform measurement data, taken in the frequency domain, to the time domain providing further insight into the behavior of linear networks.

Network analysis accomplishes the description of both active and passive networks by creating a data model of such component parameters as impedances and transfer functions. However, these parameters not only vary as a function of frequency but are also complex variables in that they have both magnitude and phase. Swept network analyzers now measure magnitude and phase (the total complex quantity) as a function of frequency with less difficulty than conventional CW measurements. Impedance and transfer functions can then be conveniently displayed on a swept CRT, as in Figure 1, X-Y recorder, or peripherals such as a printer and/or a plotter.

Thus, network analysis satisfies the engineering need to characterize the behavior of linear networks quickly, accurately, and completely over broad frequency ranges. Hewlett-Packard manufactures a full line of scalar network analyzers (magnitude only) and vector network analyzers (both magnitude and phase).

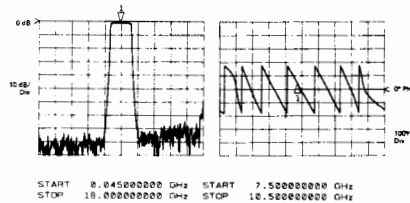

Figure 1. 45 MHz to 18 GHz measurement of magnitude and phase in a single sweep.

### What Is Network Analysis?

Network analysis is the process of creating a data model of the transfer and/or impedance characteristics of a linear network through stimulus-response testing over the frequency range of interest. All network analyzers in the HP product line operate according to this definition.

At frequencies above 1 MHz lumped elements actually become "circuits" consisting of the basic elements plus parasitics like stray capacitance, lead inductance, and unknown absorptive losses. Since parasitics depend on the individual device and its construction they are almost impossible to predict. Above 1 GHz component geometries are comparable to a signal wavelength, intensifying the variance in circuit behavior due to device construction.

Network analysis is generally limited to the definition of linear networks. Since linearity constrains networks stimulated by a sine wave to produce a sine wave output, sine wave testing is an ideal method for characterizing magnitude and phase response as a function of frequency. For non-linear measurements, refer to the sections on spectrum analyzers, wave analyzers (signal analyzers) and vector modulation products in this catalog.

### Network Analyzers

Hewlett-Packard network analyzers are instruments that measure transfer and/or impedance functions of linear networks through sine wave testing. A network analyzer system accomplishes these measurements by configuring its various components around the device under test. The first requirement of the measurement system is a sine wave signal source to stimulate the device under test. Since transfer and impedance functions are ratios of various voltages and currents, a means of separating the appropriate signals from the measurement ports of the device under test is required. Finally, the network analyzer itself must detect the separated signals, form the desired signal ratios, and display the results.

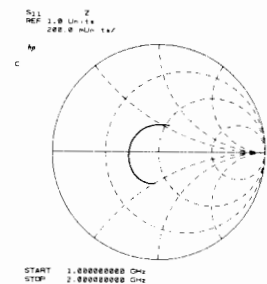

Figure 2. Input impedance of microcircuit amplifier is read directly with Smith Chart overlay for Polar Display.

### Signal Sources and Signal Separation

In the general case, any sine wave source meeting the network analyzer's specifications can be used to stimulate the device under test. If the analyzer is capable of swept measure-



ments, great economies in time can be achieved by stimulating the device under test with a sweep oscillator or synthesized sweeper. This allows quick and easy characterization of devices over broad frequency ranges.

At high frequencies the problem of signal separation usually involves traveling waves on transmission lines and becomes correspondingly more difficult. Hewlett-Packard manufactures test sets applicable for separating the appropriate traveling waves in a variety of high frequency measurements.

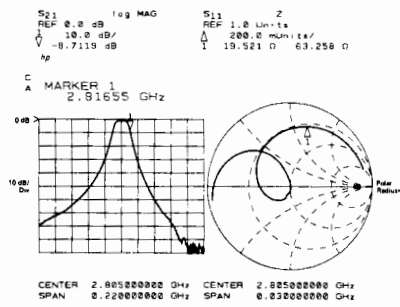

Figure 3. Simultaneous measurement of transmission response and passband reflection coefficient.

**Broadband and Narrowband Detection**

After the desired signals have been obtained from the test set they must be detected by the network analyzer; HP network analyzers can use one of two detection methods. Broadband detection accepts the full frequency spectrum of the input signal while narrowband detection involves tuned receivers that convert CW or swept RF signals to a constant IF signal. There are certain advantages to each detection scheme.

Scalar analyzers usually employ broadband detection techniques. Broadband detection reduces instrument cost by eliminating the IF section required by narrowband analyzers but sacrifices noise and harmonic rejection. However, noise is not a factor in many applications. Finally, broadband systems can make measurements where the input and output signals are not of the same frequency, as in the measurement of the insertion loss of mixers and frequency doublers. Narrowband systems cannot make these measurements.

Vector network analyzers normally employ narrowband detection techniques. Narrowband detection makes a more sensitive low noise detection of the constant IF possible. This allows increased accuracy and dynamic range for frequency selective measurements (as compared to broadband systems).

All network analyzer phase measurements are relative measurements with the reference channel signal considered to have zero phase. The analyzer then measures the phase difference of the test channel with respect to the reference channel.

Phase information complements amplitude data in the measurement of low frequency parameters. Phase is more sensitive to network behavior and it is a required component of complex impedance and transfer functions.

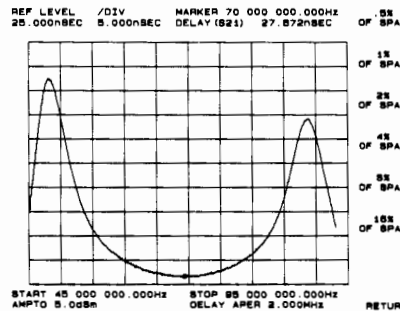

Figure 4. Direct measurement of group delay with digital readout at marker.

**Signal Processing and Display**

Once the RF has been detected, the network analyzer must process the detected signals and display the measured quantities. All HP network analyzers are multi-channel receivers utilizing a reference channel and at least one test channel; absolute signal levels in the channels, relative signal levels (ratios) between the channels, or relative phase difference between channels can be measured depending on the analyzer.

Relative ratio measurements are usually made in dB, which is the log ratio of an unknown signal (Test Channel) with a chosen reference signal (Reference Channel). This allows the full dynamic range of the instrumentation to be used in measuring variations of both high and low level circuit responses. For example, 0 dB implies the two signal levels have a ratio of unity while ±20 dB implies a 10:1 voltage ratio between two signals.

Phase data is also required to measure delay distortion or group delay of networks. Delay distortion occurs when different frequency components of a complex waveform experience nonlinear phase shifts as they are transmitted through a network. Group delay is a measure of this distortion and is defined as:

$$T_g = - \frac{d\theta}{d\omega}$$

An alternative method for measuring phase distortion is deviation from linear phase or differential phase. Deviations from linear phase can be measured by introducing enough electrical length in the network analyzer's reference channel to linearize a device's phase shift.

Scattering parameters or S-parameters were developed to characterize linear networks at high frequencies. S-parameters de-

fine the ratios of reflected and transmitted traveling waves measured at the network ports. A two-port device is modeled with S-parameters in Figure 5.  $S_{11}$  is the complex re-

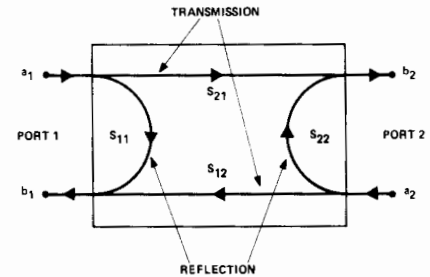

Figure 5. S-parameter model for a two-port linear network.

flexion coefficient at port 1 and is the ratio of  $b_1/a_1$ , if  $a_2 = 0$  (port 2 terminated in its characteristic impedance).  $S_{21}$  is the complex transmission coefficient from port 1 to port 2,  $b_2/a_1$ , if  $a_2 = 0$ . The "a" and "b" signals represent the amplitude and phase of the incident and emerging or reflected traveling waves. By reversing the ports and terminating port 1 in its characteristic impedance,  $S_{22}$  and  $S_{12}$  can be similarly defined.

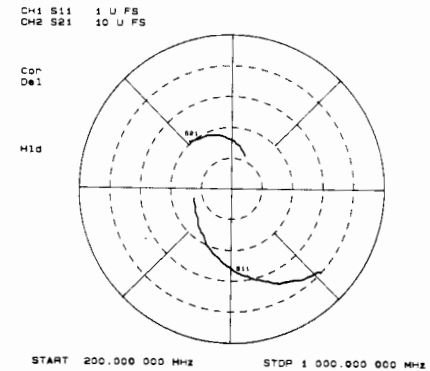

Figure 6. Simultaneous measurement of transistor S-parameters.

**Additional Capabilities**

Precision design work and manufacturing tolerances demand highly accurate measurements, but most errors in network measurements are complex quantities that vary as a function of frequency. By characterizing and virtually removing these systematic errors, measurement accuracies are improved by several orders of magnitude. Hewlett-Packard now offers network analyzers with built-in, high-speed computational hardware that can perform the complex mathematics required for sophisticated error correction.

Computer controlled network analyzers can be programmed to set up and make many measurements automatically. The measurement process is further accelerated by the computer's ability to store, transform, summarize, and output data in a variety of formats to a number of peripherals. These capabilities make the computer controlled network analyzer ideal for both computer aided design or automatic production testing.

# NETWORK ANALYZERS

## Complete Characterization of Linear Networks (cont'd)

### Network Analyzer Product Line Summary

<b>Network Analyzer</b>			
<b>HP Model</b>	<b>Frequency Range</b>	<b>Source</b>	<b>Measurement Capabilities</b>
HP 3562A Dual-Channel Dynamic Signal Analyzer Page 161	64 $\mu$ Hz-100 kHz	Swept and fixed sine, chirp, burst chirp, random noise and burst random noise	Transfer functions, magnitude/phase, 40-pole/40-zero curve fitter, frequency response synthesis, time domain functions, and spectrum analysis. HP-IB programmable
HP 3563A Dual-Channel Control Systems Analyzer Page 163	64 $\mu$ Hz-100 kHz	Analog and digital swept and fixed sine, chirp, burst chirp, random noise, burst random noise, step, pulse, ramp, and arbitrary	Transfer functions, magnitude/phase, impulse response, 40-pole/40-zero curve fitter (s- and z-domains), frequency response synthesis (s- and z-domains), time domain functions, and spectrum analysis with analog or digital input signals. HP-IB programmable.
HP 3577B Network Analyzer Page 229	5 Hz to 200 MHz	Integrated Synthesized Source	Transfer functions, magnitude/phase, group delay, s-parameters, insertion loss, gain/attenuation, electrical length, gain compression, SWR, impedance. HP Instrument BASIC optional. HP-IB programmable.
HP 4195A network/spectrum/impedance analyzer Page 232	10 Hz-500 MHz	Integrated Synthesized source	Transfer functions, magnitude/phase, insertion loss, gain, attenuation, group delay, s-parameters, return loss, SWR, complex impedance, accuracy enhancement. HP-IB programmable
HP 8751A Network Analyzer Page 236	5Hz - 500MHz	Integrated Synthesized Source	Transfer functions - magnitude/phase, insertion loss/gain, attenuation, gain compression, s-parameters, electrical length, group delay, deviation from linear phase. Impedance-magnitude/phase - Return Loss, R+jX Full Accuracy Enhancement HP Instrument BASIC capability HP-IB capability
HP 8752A Network Analyzer Page 238	300kHz-1.3/3.0 GHz	Integrated synthesized source, test set and receiver	Transfer functions - magnitude/phase, insertion loss/gain, attenuation, gain compression, s-parameters, electrical length, group delay, deviation from linear phase. Impedance-magnitude/phase, return loss, r+jx, accuracy enhancement, time domain capability, HP-IB programmable
HP 8753C Network Analyzer Page 240	300 kHz-3 GHz/6 GHz	Integrated Synthesized Source	Transfer functions - magnitude/phase insertion loss/gain, attenuation, gain compression, s-parameters, electrical length, group delay, deviation from linear phase. Impedance - magnitude/phase - Return Loss, r+jx Full Accuracy Enhancement Time Domain Capability Harmonic Measurement Capability HP-IB programmable
HP 8719A/8720B Network Analyzers Page 246	130 MHz-13.5 GHz (8719A) 130 MHz-20 GHz (8720B)	Integrated Synthesized Source (1 Hz Resolution Optional)	Transfer functions - magnitude/phase insertion loss/gain, attenuation, s-parameters, electrical length, group delay, deviation from linear phase. Impedance - magnitude/phase - Return Loss, r+jx Full Accuracy Enhancement Time Domain Capability HP-IB programmable
HP 8510 Series Network Analyzer Page 248	45 MHz to 110 GHz	HP 8350 Series Sweep Oscillators HP 8340B, 8341B Synthesized Sweepers HP 8360 Synthesized Sweepers	Transfer functions - magnitude/phase, insertion loss, gain, attenuation, s-parameters, electrical length, group delay, deviation from linear phase, impedance, return loss, R+jx Active device characterization Active device characterization Full Accuracy Enhancement Time Domain Capability HP-IB programmable

### Vector Voltmeter

<b>HP Model</b>	<b>Frequency Range</b>	<b>Source</b>	<b>Measurement Capabilities</b>
HP 3575A Gain Phase Meter Page 231	1 Hz-13 MHz	None	Gain, Phase and Amplitude
HP 8508A Vector Voltmeter Page 245	0.1 MHz-1 GHz 0.3 MHz-2 GHz	None	Voltage, Impedance Transfer Functions, phase and amplitude HP-IB programmable

### Scalar Analyzer

<b>HP Model</b>	<b>Frequency Range</b>	<b>Source</b>	<b>Measurement Capabilities</b>
HP 8757C/E Scalar Network Analyzer page 226	10 MHz-110 GHz	HP 8350 Series Sweep Oscillator, HP 8340B or 8341B HP 8360 series Synthesized Sweepers	Scalar Transmission/Reflection Measurements 50 $\Omega$ Coax Measurements 10 MHz-50 GHz 75 $\Omega$ Coax Measurements 10 MHz-2.4 GHz Waveguide Measurements 26.5 GHz-110 GHz Open/Short Averaging, Normalization, Averaging, Limit Testing Storage Registers, HP-IB Programmable

# NETWORK ANALYZERS

## Scalar Network Analyzers. 10 MHz to 110 GHz

### HP 8757C/E

219

- 76 dB dynamic range
- Accurate swept power measurements
- 40 dB directivity bridges
- 40 GHz in coax, 110 GHz in waveguide

- Buffered plotter/printer output
- External disk and internal register save/recall
- Limit testing built in
- Precision color display

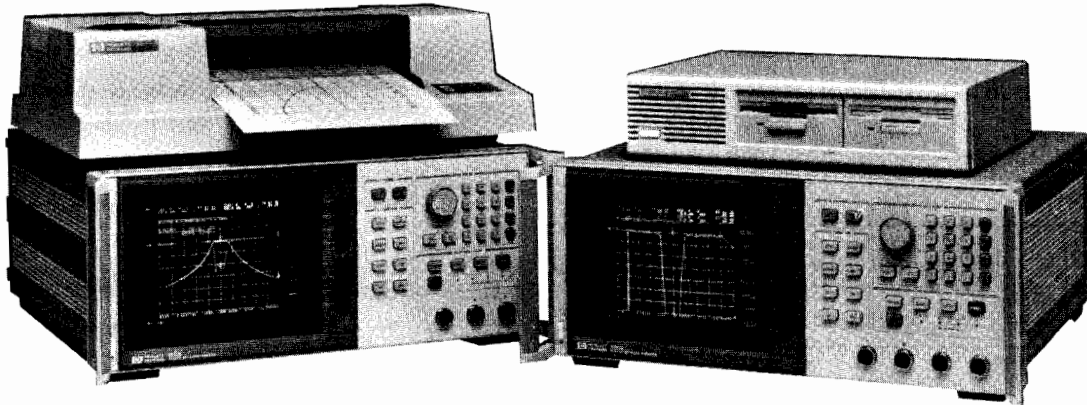

HP 8757E and HP 8757C option 001

Measure insertion loss, gain, return loss, SWR, and power quickly and accurately with either the HP 8757C or HP 8757E Scalar Network Analyzers. With high-performance detectors and directional bridges, and a companion HP source and digital plotter, the HP 8757C and 8757E become the basis of a complete measurement system with superb performance.

#### A Choice of Two Analyzers

For an economical measurement solution, choose the HP 8757E Scalar Network Analyzer. The HP 8757E features three detector inputs and two independent display channels, allowing simultaneous ratioed or non-ratioed measurement of your device's transmission and reflection characteristics, 76 dB dynamic range (+16 to -60 dBm) for measuring high rejection devices, and a choice between AC (square wave modulated) or DC detection techniques. The internal plotter/printer buffer allows you to send your measurement data directly to a plotter and then proceed to the next measurement, typically in less than 5 seconds. The HP 8757E includes a user-friendly interface, and menu-driven, direct-access softkeys, which simplify its operation.

When your application demands maximum system versatility, choose the HP 8757C Scalar Network Analyzer. It offers all of the performance of the HP 8757E, plus more features, limit testing, external disk save/recall, and a color display. Limit testing reduces test time by letting the analyzer make quick and objective pass/fail decisions. External disk save/recall allows your measurement state to be preconfigured by an engineer or skilled specialist and then automatically recalled by production technicians. The result is reduced setup time and greater test integrity at each production station. The precision color display simplifies the separation of measurement information while providing a pleasant display for the technician.

#### Systems from 10 MHz to 110 GHz

You can conveniently obtain a 20 GHz or 40 GHz coaxial measurement system by ordering the HP 8757XA (10 MHz to 20 GHz) or HP 8757XB (10 MHz to 40 GHz) scalar measurement system. Or, you can configure your own system to 50 GHz in coax or 110 GHz in waveguide.

The HP 8350B sweep oscillator family offers the benefits of a modular system with choices in source frequency range and output power. When testing narrowband, frequency-selective devices, choose a synthesized sweeper from the HP 8360 series or an HP 8340B or 8341B. The HP 8360 series, 8340B, and 8341B provide excellent frequency stability and up to 1 Hz frequency resolution.

#### Accessories Ensure Measurement Accuracy

Minimize transmission measurement uncertainty by using detectors with an unrivaled match (HP 85025E: >25 dB return loss to 25 GHz). Maximize your reflection measurement accuracy with high directivity directional bridges (HP 85027A,B,D: >40 dB to 20 GHz, HP 85027D: >25 dB to 50 GHz). The HP 8757C/E are compatible with a broad line of high-performance detectors, directional bridges, and other accessories that help reduce your measurement errors.

Feature	HP 8757C	HP 8757E
Display	Color	Monochrome
Display channels	4	2
Detector inputs	3 standard 4 with option 001	3
Dynamic range	76 dB	76 dB
AC/DC detection mode	Yes	Yes
Measurement points: Selectable values	101, 201, 401, 801, 1601	101, 201, 401
Channels Displayed	3 or 4	2
Max Points per channel	401	801
Plotter/printer buffer	Yes	Yes
Noise figure display capability	Yes	Yes
External disk save/recall	Yes	No
Internal save/recall registers	9	9
Limit testing (channels 1 and 2)	Yes	No
Adaptive normalization	Yes	No
Cursor search functions	Max, Min, bandwidth, n dB	Max, min
SWR display mode	Yes	Yes
Non-standard sweep mode	Yes	Yes
Auxiliary voltage display mode	Yes	Yes

### System Specifications

#### Accuracy

**Transmission loss or gain measurement accuracy:** Transmission loss or gain measurements are made relative to a 0 dB reference point established at calibration. The measurement accuracy is equal to the uncertainty due to the change in power level, called dynamic accuracy, plus mismatch uncertainty. The frequency response errors of the source, detectors, bridge and power splitter may be removed via calibration.

**Dynamic power accuracy** (25 ±5°C, 0 dBm reference):

#### Coax detectors\* (50 MHz)

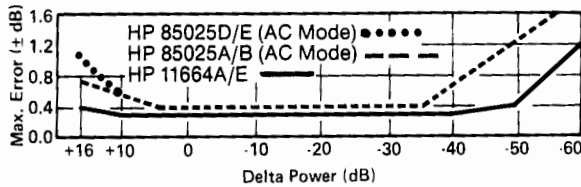

\*For ≤20 dB change of power within +10 to -40 dBm, the specification for the HP 8757 with the HP 11664A/E is ±(0.1 dB + 0.01 dB/dB).

#### Waveguide detectors

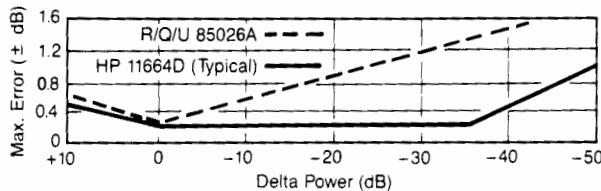

**Absolute power measurement accuracy:** This specification is useful for determining the accuracy of power measurements in dBm when using the HP 85025A/B/D/E detectors in the DC mode. The total uncertainty is the sum of the detector frequency response, power accuracy, and mismatch uncertainties.

**Absolute power accuracy** (HP 85025A/B/D/E detectors in DC mode, 50 MHz, 25 ±5°C):

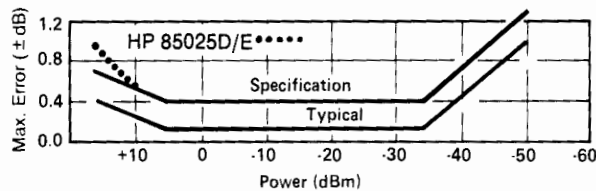

**Detector frequency response** (HP 85025A/B detectors, -10 dBm, 25 ±5°C):

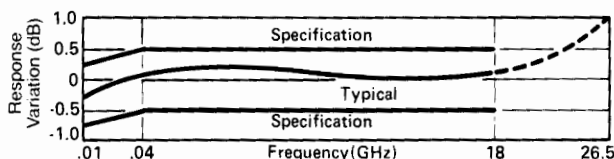

**Dynamic Range** (on all HP 8757 detector inputs):

Detector	ac Mode	dc Mode
HP 11664A/E	+16 to -60 dBm	
HP 11664D	+10 to -50 dBm	
HP 85025A/B/D/E	+16 to -55 dBm	+16 to -50 dBm
HP R/Q/U85026A	+10 to -50 dBm	+10 to -45 dBm

**Reflection measurement accuracy:** Uncertainties due to calibration error and the frequency response of the source, detectors and bridge are removed via open/short averaging. The remaining uncertainties are primarily the sum of directivity uncertainty, effective source match uncertainty, and dynamic power accuracy. As shown in the graphs below, directivity is the dominant error term when measuring small reflected signals (high return loss) and source match is dominant when measuring large reflected signals (low return loss).

**Effect of effective source match on reflection uncertainty:**

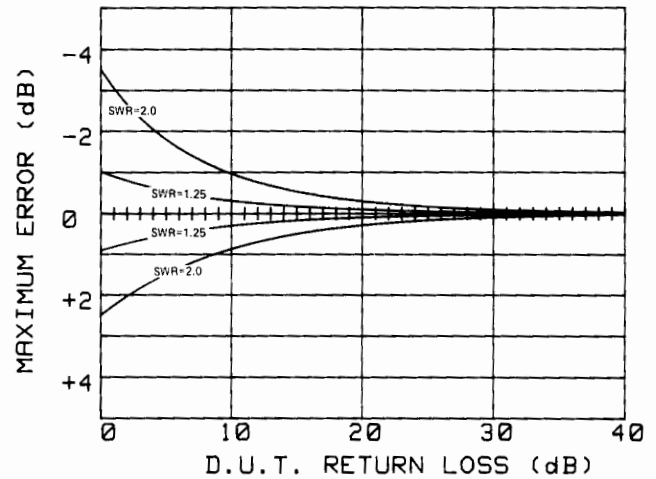

**Effect of directivity on reflection uncertainty:**

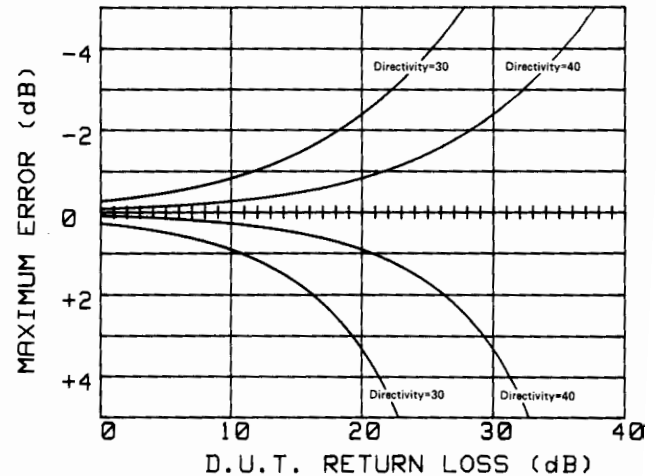

**Dynamic power accuracy** (HP 85027/20 bridges, 50 MHz, 25 ±5°C, +7 dBm input):

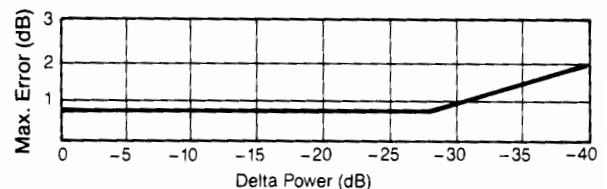

HP 85027A/B/C/D/E, 85020A/B, 85025A/B/C/D/E, 11664A/C/D/E, R/Q/U 85026A

### Directional Bridges

The HP 85020 series and HP 85027 series are directional bridges designed especially for the HP 8757, 8756 and 8755 scalar network analyzers. Each bridge features outstanding directivity and test port match in a compact, rugged package.

Within each bridge, one zero-bias Schottky diode detector measures the return loss of the test device. Ratio measurements can be made by adding a power splitter (HP 11667A/B/C) and detector (HP 11664 series or HP 85025 series).

### HP 85027A/B/C/D/E Directional Bridges

The HP 85027 series directional bridges are designed to operate with the HP 8757, 8756 and 8755 scalar network analyzers for reflection measurements from 10 MHz to 50 GHz. A switch on the HP 85027 series bridges allows the user to configure them for operation with the HP 8757 or the HP 8756 and 8755 scalar network analyzers.

When used with the HP 8757 scalar network analyzer, the HP 85027 series bridges allow the user to choose the measurement mode that best suits the application. Use the bridge's AC mode (modulated RF) for measurements in the presence of undesired signals such as broadband noise or electromagnetic interference. Or choose the bridge's DC mode (unmodulated RF) to measure the return loss of modulation sensitive devices such as amplifiers with gain control circuits. Use the companion HP 85025 series detectors for AC and DC measurement versatility or the HP 11664 series detectors for AC only measurements.

High (40 dB) directivity and excellent test port match ensure accurate reflection measurements over a broad swept frequency range. The HP 85027B bridge operates from 10 MHz to 26.5 GHz and has an SMA compatible, precision female 3.5mm test port connector. The HP 85027A/C bridges operate from 10 MHz to 18 GHz. The HP 85027A has a rugged 7mm test port connector and the HP 85027C has a precision Type-N connector. The HP 85027E operates from 10 MHz to 26.5 GHz and has an SMA compatible, precision male 3.5mm test port connector. Reflection measurements from 10 MHz to 50 GHz are possible using the HP 85027D directional bridge.

### Measuring SMA devices

Hewlett-Packard recommends using the HP 85027A bridge and an 7mm to 3.5mm adapter for measuring SMA devices from 10 MHz to 18 GHz. For SMA measurements to 26.5 GHz, HP recommends using 3.5mm to 3.5mm adapters (included with the HP 85027B/E bridge) to preserve the HP 85027B/E output connector.

### HP 85020A/B Directional Bridges

The economical HP 85020A/B directional bridges also offer high (40 dB) directivity and excellent port match at RF (to 4.3 GHz) frequencies. For 50 ohm measurements choose the HP 85020A. The HP 85020B is designed for 75 ohm environments. Both RF bridges have Type-N connectors.

Two types of detectors are available for use with HP scalar network analyzers for measurements up to 60 GHz. All detectors provide excellent impedance match, and therefore minimize mismatch uncertainty in scalar measurements.

### HP 85025 and 85026 Series Detectors (AC/DC)

The HP 85025 and 85026 series detectors are designed specifically for operation with the HP 8757 Scalar Network Analyzer and are not compatible with either the HP 8756 or the 8755. The HP 85025/26 detectors detect either a modulated (AC) or an unmodulated (DC) microwave signal. In AC mode, the HP 85025/26 series detect the envelope of the 27.8 kHz modulated microwave signal, provided internally by the HP 8350B Sweep Oscillator with RF plug-in and the HP 8360 series synthesized sweepers or externally with the HP 8340/41 synthesized sweepers. In DC mode, the HP 85025/26 series detectors measure the microwave power directly without modulation. The user can change detection modes from the HP 8757 front panel.

### HP 11664 Series Detectors (AC Only)

The HP 11664 series detectors are designed to operate with the HP 8757, 8756 and 8755 scalar analyzers in AC mode only. The HP 11664A/E cover the 10 MHz to 26.5 GHz range, and the HP 11664D covers from 26.5 to 40 GHz.

### Detector Adapters

The HP 85025C and the HP 11664C Detector Adapters match the scalar analyzer display to most standard crystal, silicon, and gallium arsenide detectors. This enables the user to operate up to 110 GHz with the HP 8757 and the HP 8756.

The HP 85025C Detector Adapter is designed for use with the HP 8757 only, and can operate in either AC or DC detection modes. A softkey calibration sequence calibrates the HP 8757 display to your particular detector for an accurate display of power level. The analyzer can then account for the voltage versus input power characteristics of the detector in use. This calibration requires two known calibration inputs, one at a high level (linear operating region, above 0 dBm) and one at a low level (square law region, below -20 dBm).

The HP 11664C Detector Adapter is designed for use with the HP 8757, 8756, and 8755 scalar analyzers. The HP 11664C is matched to the particular diode used via two screwdriver adjustments. One adjustment sets the adapter's amplifier gain to the correct power level indication on the scalar network analyzer. The second adjustment matches the input impedance of the adapter to the load impedance of the detector. Together, the voltage versus power characteristics of the detector are calibrated for the scalar analyzer display.

### Detector Summary

For use with the HP 8757, 8756, or 8755 in AC detection mode only:

Detector	Freq. Range (GHz)	Connector Type	Return Loss (dB)	Dynamic Range		Weight	
				8757	8756	Net	Shipping
11664A <sup>1</sup>	.01-18	Type-N (m)	.01-.04 GHz: 10 dB .04-4 GHz: 20 dB 4-12 GHz: 18 dB 12-18 GHz: 16 dB	+16 to -60 dBm	+10 to -50 dBm	0.17 kg (0.4 lb)	0.9 kg (2 lb)
11664E	.01-26.5	3.5 mm (m)	.01-.04 GHz: 10 dB .04-6 GHz: 20 dB 6-20 GHz: 16 dB 20-26.5 GHz: 12 dB	+16 to -60 dBm	+10 to -50 dBm	"	"
11664D	26.5-40	WR-28	12 dB	+10 to -50 dBm	+10 to -50 dBm	0.24 kg (0.5 lb)	1.0 kg (2.2 lb)
11664C	<sup>3</sup>	SMA (m)	<sup>3</sup>	<sup>3</sup>	<sup>3</sup>	0.17 kg (0.4 lb)	0.9 kg (2 lb)

# NETWORK ANALYZERS

## 8757 System Accessories

HP 85027A/B/C/D/E, 85020A/B, 85025A/B/C/D/E, R/Q/U85026A, 11664A/C/D/E

### Detector Summary (cont'd)

For use with HP 8757 only in either ac or dc detection modes:

				ac mode		dc mode	
85025A <sup>1, 2</sup>	.01-18	Type-N (m)	.01-.04 GHz: 10 dB .04-4 GHz: 20 dB 4-18 GHz: 17 dB	+16 to -55 dBm	+16 to -50 dBm	0.24 kg (0.5 lb)	1.0 kg (2.2 kg)
85025B <sup>2</sup>	.01-26.5	3.5mm (m)	.01-18 GHz: Same as 85025A 18-26.5 GHz: 12 dB	+16 to -55 dBm	+16 to -50 dBm	0.24 kg (0.5 lb)	1.0 kg (2.2 kg)
85025D	.01-50 GHz	2.4mm (m)	10-40 MHz: 10 dB 40-100 MHz: 20 dB .1-14 GHz: 23 dB 14-34 GHz: 20 dB 34-40 GHz: 15 dB 40-50 GHz: 9 dB	+16 to -55 dBm	+16 to -50 dBm	0.24 kg (0.5 lb)	1.0 kg (2.2 kg)
85025E	.01-26.5 GHz	3.5mm (m)	10-40 MHz: 10 dB 40-100 MHz: 20 dB .1-25 GHz: 25 dB 25-26.5 GHz: 23 dB	+16 to -55 dBm	+16 to -50 dBm	0.24 kg (0.5 lb)	1.0 kg (2.2 kg)
R85026A <sup>2</sup>	26.5-40	WR-28	12 dB	+10 to -50 dBm	+10 to -45 dBm	0.24 kg (0.5 lb)	1.0 kg (2.2 kg)
Q85026A <sup>2</sup>	33-50	WR-22	12 dB	+10 to -50 dBm	+10 to -45 dBm	0.24 kg (0.5 lb)	1.0 kg (2.2 kg)
U85026A <sup>2</sup>	40-60	WR-19	12 dB	+10 to -50 dBm	+10 to -45 dBm	0.24 kg (0.5 lb)	1.0 kg (2.2 kg)
85025C K57	50-75 GHz	WR-15		-10 to -50 dBm (typical)	-10 to -45 dBm (typical)	0.24 kg (0.5 lb)	1.0 kg (2.2 kg)
85025C K71	75-110 GHz	WR-10		-10 to -50 dBm (typical)	-10 to -45 dBm (typical)	0.24 kg (0.5 lb)	1.0 kg (2.2 kg)
85025C <sup>2</sup>	<sup>3</sup>	SMA (m)	<sup>3</sup>	<sup>3</sup>	<sup>3</sup>	0.24 kg (0.5 lb)	1.0 kg (2.2 kg)

### Directional Bridge Summary

For use with the HP 8757, 8756, or 8755 in ac detection mode only:

Bridge	Freq. Range (GHz)	Nominal Impedance	Connector		Directivity (dB)	Test Port Match (SWR)	Weight	
			Input	Test port			Net	Shipping
85020A	.01-4.3 GHz	50 ohms	Type-N (f)	Type-N (f)	.01-3 GHz: 40 dB 3-4.3 GHz: 34 dB	.01-3 GHz: <1.20 3-4.3 GHz: <1.25	0.5 kg (1.2 lb)	2.3 kg (5 lb)
85020B	.01-2.4 GHz	75 ohms	Type-N (f)	Type-N (f)	40 dB	.01-1.3 GHz: <1.25 1.3-2.4 GHz: <1.39	0.5 kg (1.2 lb)	2.3 kg (5 lb)

For use with the HP 8756, or 8755 in ac detection mode or with the HP 8757 in either ac or dc detection modes

85027A	.01-18 GHz	50 ohms	Type-N (f)	7mm	40 dB	.01-8.4 GHz: <1.15 8.4-12.4 GHz: <1.25 12.4-18 GHz: <1.43	0.5 kg (1.2 lb)	2.3 kg (5 lb)
85027B	.01-26.5 GHz	50 ohms	3.5mm (f)	3.5mm (f)	.01-20 GHz: 40 dB 20-26.5 GHz: 36 dB	.01-8.4 GHz: <1.15 8.4-20 GHz: <1.43 20-26.5 GHz: <1.78	0.5 kg (1.2 lb)	2.3 kg (5 lb)
85027C	.01-18 GHz	50 ohms	Type-N (f)	Type-N (f)	.01-12.4 GHz: 36 dB 12.4-18 GHz: 34 dB	.01-8.4 GHz: <1.15 8.4-12.4 GHz: <1.25 12.4-18 GHz: <1.43	0.5 kg (1.2 lb)	2.3 kg (5 lb)
85027D	.01-50 GHz	50 ohms	2.4mm (f)	2.4mm (m)	.01-20 GHz: 36 dB 20-26.5 GHz: 32 dB 26.5-40 GHz: 30 dB 40-50 GHz: 25 dB	.01-16 GHz: <1.15 16-30 GHz: <1.25 30-40 GHz: <1.40 40-50 GHz: <2.20 (typical)	0.5 kg (1.2 lb)	2.3 kg (5 lb)
85027E	.01-26.5 GHz	50 ohms	3.5mm (f)	3.5mm (m)	.01-20 GHz: 40 dB 20-26.5 GHz: 36 dB	.01-8.4 GHz: <1.15 8.4-20 GHz: <1.43 20-26.5 GHz: <1.75	0.5 kg (1.2 lb)	2.3 kg (5 lb)

1. Option 001 changes to 7mm connector.

2. The HP 85025 and 85026 series detectors and the HP 85025C require HP 8757A firmware revision 2.0 or higher.

To upgrade previous revisions order the HP 11614A Firmware Enhancement.

3. Depends on the particular external detector used.

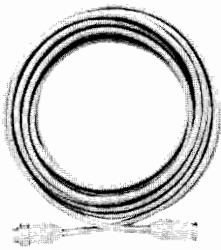

HP 11679A

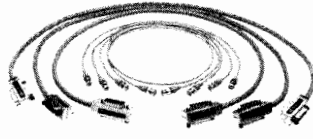

HP 85022A

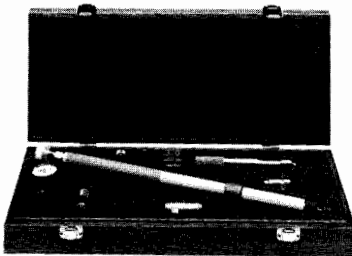

HP 85028A



HP 85023C



HP 11668A

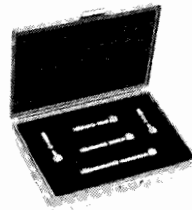

HP 11678A

#### HP 11679A/B Extension Cables

**Function:** These cables extend the distance between the scalar network analyzer and the detector or bridge to a maximum of 200 feet without degradation of performance.

HP 11679A: 7.6 m (25 ft) extension cable

HP 11679B: 61 m (200 ft) extension cable

#### HP 85023A/B/C/D/F Verification Kits

The HP 85023 Series system verification kits each contain a set of precision components used to perform a system verification procedure for the HP 8757 scalar network analyzer system. This procedure, which is in the HP 8757/56 Operating and Service Manuals, checks system installation and can be used as a daily functional test.

Choose a system verification kit to match your device under test. For 7mm applications, select the HP 85023A. If you are measuring SMA or 3.5mm devices, choose the HP 85023B. For 50 ohm, Type-N applications, select the HP 85023C. These kits (HP 85023A/B/C) all include an open, short, 10 dB fixed attenuator, 50 ohm termination, and a source to directional bridge adapter of the corresponding connector type. The HP 85023D verification kit, for 75 ohm Type-N measurements, consists of a short, a 75 ohm termination, a 50 ohm 10 dB fixed attenuator and two HP 11852B 50 to 75 ohm minimum loss pads (for 50/75 ohm impedance conversion).

The HP 85023F verification kit includes 2.4mm standards for verifying performance of the HP 8757 system to 50 GHz. Included are a 2.4mm female open, short and 50 ohm load, a 10 dB attenuator, and female to female adapter.

**Frequency range:** HP 85023A/C, dc to 18 GHz.

HP 85023D, dc to 1.3 GHz.

HP 85023B, dc to 26.5 GHz.

HP 85023F, dc to 50 GHz.

**Connector type:** HP 85023A, 7mm.

HP 85023B, 3.5mm.

HP 85023C, Type-N, 50 ohm.

HP 85023D, Type-N, 75 ohm.

HP 85023F, 2.4mm, 50 ohm.

**Characteristic impedance:** HP 85023A/B/C/F, 50 ohm.

HP 85023D, 75 ohm.

**Weight:** net, 0.5 kg (1.2 lb); shipping, 1.2 kg (2.9 lb).

#### HP 85022A System Cable Kit

The HP 85022A contains all the BNC and HP-IB cables to connect an HP 8350B sweep oscillator (or the HP 8360 series, HP 8340B/41B synthesized sweepers), an HP Series 200 or 300 computer, and a printer to the HP 8757 or 8756. This kit contains 3 one-meter HP-IB cables (HP 10833A), 3 two-foot BNC cables (HP 11170B), and 1 four-foot BNC cable (HP 11170C).

**BNC connectors:** N-Male, N-Male.

**BNC impedance:** 50 ohm.

**Weight:** net, 0.5 kg (1.2 lb); shipping, 1.2 kg (2.9 lb).

#### HP 85028A 7mm Directivity Verification Standards for HP 85021A/85027A

The HP 85028A allows on-site verification of the 40 dB directivity of the HP 85021A and 85027A directional bridges. For frequencies below 2 GHz, a precision 52 dB return loss load is used. For frequencies from 2 to 18 GHz, a sliding mismatch is used to establish a ripple pattern from which the directivity can be calculated. The HP 85028A includes a precision 50 ohm termination, a high-performance sliding mismatch, a 7mm open/short, an 7mm connector gage kit, and a torque wrench.

**Weight:** net, 2.0 kg (4.5 lb); shipping, 3.5 kg (8.0 lb).

#### HP 11614A Firmware Enhancement

The HP 11614A firmware enhancement updates the HP 8757A scalar network analyzer to firmware revision 2.1. (HP 8757As with serial number prefix 2802A or higher already have revision 2.1 firmware). Firmware revision 2.1 added several new features to previous versions of the HP 8757A. These include the ability to display and plot reflection traces in units of standing wave ratio (SWR), tabular listings of numerical data on an HP ThinkJet printer, full calibration and operation with the HP 85025C detector adapter and R/Q/U85026A waveguide detectors, and the ability to display and plot an external voltage applied to a rear panel input. All revision 2.1 features are HP-IB programmable.

#### HP 8757C/E Firmware Update

Update the HP 8757C (serial prefix 3004A and below) to revision 3.1 or the HP 8757E (serial prefix 3004A and below) to revision 4.1 with a firmware update kit. These kits enhance the operation of the HP 8757C/E by adding:

- Synthesized step sweep measurements with the HP 8360 series synthesized sweepers.
- Plotter buffer on/off selection.
- Cursor format selection, SWR or dB, while displaying device match in dB.

All 3.1 and 4.1 revision features are HP-IB programmable

HP 8757C firmware update kit: 08757-60099

HP 8757E firmware update kit: 08757-60098

# NETWORK ANALYZERS

## 8757 System Accessories (cont'd)

HP 11613B, 11636A/B, 11665B, 11668A, 11852B

### HP 11668A High Pass Filter

The HP 11668A high pass filter accessory is recommended when making measurements on active devices that have gain below 50 MHz. Use of the HP 11668A, placed after the HP 11665B, reduces the modulator drive feedthrough from 8 mV to 1 mV and prevents possible amplifier saturation. Use of the HP 11668A filter is not necessary for passive measurements since the feedthrough from the HP 11665B is  $-65$  dBm and causes no degradation in system performance.

**Frequency range:** 50 MHz to 18 GHz.

	Insertion Loss	Return Loss
50-100 MHz	$\leq 2.5$ dB	$\geq 12$ dB
100 MHz-8 GHz	$\leq 1.0$ dB	$\geq 16$ dB
8-12 GHz	$\leq 1.0$ dB	$\geq 14$ dB
12-18 GHz	$\leq 1.5$ dB	$\geq 14$ dB

**Maximum input:** +27 dBm.

**Connectors:** N-female, N-male.

**Weight:** net, 0.13 kg (5 oz); shipping, 0.28 kg (10 oz.).

### HP 11678A Low Pass Filter Kit

**Description:** the HP 11678A low pass filter kit contains five filters. Low pass filters reduce harmonics generated by the RF source when making precision measurements.

**Frequency Range** (low pass filters, cutoff frequency fc)

HP 11688A: 2.8 GHz.

HP 11689A: 4.4 GHz.

HP 11684A: 6.8 GHz.

HP 11685A: 9.5 GHz.

HP 11686A: 13.0 GHz.

**Insertion loss:**  $< 1.1$  dB at 0.95 fc.

**Rejection** (at 1.25 fc): greater than 40 dB.

**Impedance:** 50 ohm normal.

**Connectors:** N-Female, N-Male.

**Weight:** net, 0.44 kg (1 lb); shipping, 1.2 kg (2.9 lb).

### HP 11613B Calibrator

HP 8757 and 8756 verification/calibration is recommended every 12 months. This can be accomplished at an HP service center or on-site using the HP 11613B calibrator and an HP 9000 series 200 or series 300 computer.

The HP 11613B is a dedicated transfer standard for calibration of the HP 8757 and 8756. The HP 11613B provides the standard a 27.778 kHz source and a series of precision attenuators. The calibrator includes software (both 3.5 and 5.25 inch formats) that operates on an HP 9000 series 200 or series 300 computer, the BASIC operating system (BASIC 2.0, and above) and a GP-IO cable for use when calibrating the HP 8756. The software verifies (and adjusts if necessary) the internal calibration parameters stored in the non-volatile memory of the HP 8757 and 8756. All HP 8757 and 8756 detector inputs can be calibrated in a matter of minutes. Re-calibration of the HP 11613B is recommended every two years.

**Memory Requirement:** 1/2M byte, including BASIC.

**Hardware Requirement:** HP 98622A 16-bit GP-IO interface card for use with HP 8756.

**Dimensions:** 40 H x 185 W x 203 mm D (1.5 x 7.3 x 8.0 in).

**Cable length:** 1.22 m (48 in).

**Weight:** Net 0.91 kg (2 lbs). Shipping 1.4 kg (3 lbs).

HP 11665B

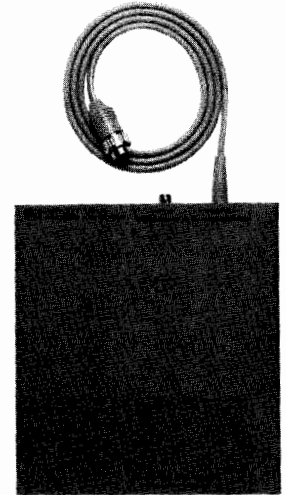

HP 11613B

### HP 11636A/B Power Dividers

The HP 11636A/B power dividers/combiners are recommended when making wideband comparison measurements without ratioing, and in fault location measurements with the HP 8757/85016. Detailed specifications are on page 349.

### Other Signal Separation Devices

Many other signal separation devices are available from HP for use with the HP 8757, 8756 and 8755. Coaxial couplers from 0.1 to 18 GHz are available with the HP 770 series, the 790 series, and the HP 11692. Higher directivity HP 752 series waveguide couplers can also be used with the HP 8757, 8756 or 8755 with the addition of appropriate HP 281 series waveguide-to-coax adapters.

### 11665B Modulator

**Function:** absorptive on-off modulator designed for and powered by the HP 8757, 8756 or 8755 scalar network analyzers.

Frequency Range	Return Loss On and Off	Insertion Loss On Off
15-40 MHz	$\geq 10$ dB	$\leq 7.0$ dB $\geq 35$ dB
40 MHz-4 GHz	$\geq 15$ dB	$\leq 3.2$ dB $\geq 35$ dB
4-8 GHz	$\geq 12$ dB	$\leq 3.8$ dB $\geq 40$ dB
8-12.4 GHz	$\geq 8$ dB	$\leq 4.3$ dB $\geq 45$ dB
12.4-18 GHz	$\geq 8$ dB	$\leq 5.0$ dB $\geq 45$ dB

**Modulator drive feedthrough:**  $\leq 8$  mV (peak) at 27.8 kHz at either port when powered by the HP 8757, 8756 or 8755. Reduced to  $\leq 1$  mV (peak) using the HP 11668A. (See HP 11668A High Pass Filter).

**Drive current:** nominally +50 mA in On condition, -50 mA Off condition.

**Weight:** net, 0.17 kg (6 oz); shipping, 0.9 kg (2 lb).

### HP 11852B 50 ohm/75 ohm Minimum Loss Pad

The HP 11852B is a low SWR minimum loss pad required between 75 ohm devices and 50 ohm sources and detectors. For more information, see page 243.





HP 11667A

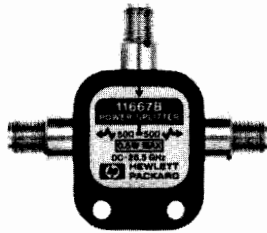

HP 11667B

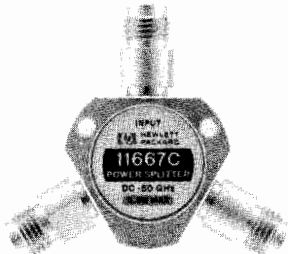

HP 11667C

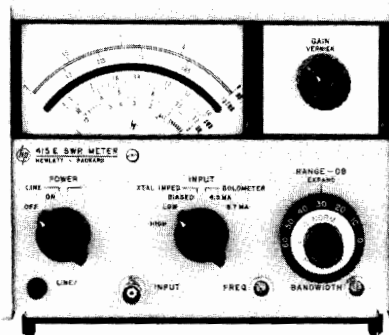

HP 415E

#### HP 415E SWR Meter

HP 415E SWR Meter is a low noise, 1000 Hz tuned amplifier and voltmeter, calibrated in dB and SWR. Designed for use with square law detectors, it measures SWR, attenuation, and gain directly from metered scales, or drives an X-Y recorder for RF substitution measurements. Front panel INPUT switch selects unbiased low (50-200 Ω) or high (2500-10,000 Ω) impedance crystal, biased crystal (1 V into 1 kΩ), or low or high current bolometer (4.5 or 8.7 mA ± 3% into 200 Ω).

An internal precision 60 dB attenuator allows the HP 415E to operate over a 70 dB range in 10 or 2 dB steps, with ±0.05 dB accuracy for a 10 dB step; maximum cumulative error between any two 10 dB steps is ±0.1 dB. Sensitivity is 0.15 μV rms for full scale deflection at maximum bandwidth (1 μV rms on high impedance crystal input).

Continuously adjustable bandwidth can be adjusted from 15 Hz for maximum sensitivity at CW frequencies to 130 Hz for swept frequency uses. An optional rechargeable battery pack provides up to 36 hours of continuous operation for portable use.

**Weight:** Net 4 kg (9 lb); shipping 5.8 kg (13 lb).

**Power:** 115-230 V ±10%, 50-400 Hz, 1 VA.

**Dimensions:** 155Hx190Wx279mm D(6<sup>3</sup>/<sub>32</sub>"x7<sup>25</sup>/<sub>32</sub>"x11")

#### HP 11667A/B/C Power Splitters

The HP 11667A/B/C power splitters are recommended when making wideband ratio measurements using the HP 8757, 8756, or 8755 scalar network analyzer. These two-resistor type splitters provide excellent output SWR at the auxiliary arm when used for source leveling or ratio measurement applications. The tracking between output arms over a frequency range from dc to 50 GHz allows wideband measurements to be made with a minimum of uncertainty.

#### Frequency Range:

HP 11667A dc to 18 GHz.

HP 11667B dc to 26.5 GHz.

HP 11667C dc to 50 GHz.

**Impedance** 50 ohms nominal.

#### Insertion Loss

HP 11667A/B: 6 dB nominal.

HP 11667A	dc to 4 GHz	dc to 8 GHz	dc to 18 GHz
<b>Input SWR:</b>	≤1.15	≤1.25	≤1.45
<b>Equivalent Output SWR:</b> (leveling or ratio measurements)	≤1.10	≤1.20	≤1.33
<b>Output Tracking (dB):</b> (between output arms)	≤0.15	≤0.20	≤0.25
<b>Typical Phase Tracking (deg):</b> (between output arms)	0.5	1.5	3.0

HP 11667B/C	dc to 18 GHz	dc to 26.5 GHz	dc to 40 GHz	dc to 50 GHz
<b>Input SWR:</b> HP 11667B HP 11667C	≤1.22 ≤1.22	≤1.29 ≤1.38	≤1.50	≤1.65
<b>Equivalent Output SWR:</b> (leveling or ratio measurements) HP 11667B HP 11667C	≤1.22 ≤1.29	≤1.22 ≤1.29	≤1.50	≤1.65
<b>Output Tracking (dB):</b> (between output arms) HP 11667B HP 11667C	≤0.25 ≤0.30	≤0.40 ≤0.35	≤0.40	≤0.40
<b>Typical Phase Tracking (deg):</b> (between output arms) HP 11667B HP 11667C	1.5 2.0	2.5 2.5	3.0	3.0
<b>Typical Insertion Loss(dB):</b> HP 11667C	6.0	7.0	8.0	8.5

**Maximum Input Power:** +27 dBm

#### Connectors

HP 11667A N-female on all ports.

HP 11667B APC-3.5 female on all ports.

HP 11667C 2.4 mm female on all ports.

#### Dimensions

HP 11667A 46 H x 52 W x 19 mm D (1.8" x 2.0" x 0.7")

HP 11667B 40 H x 47 W x 10 mm D (1.6" x 1.9" x 0.4")

HP 11667C 36 H x 36 W x 10 mm D (1.4" x 1.4" x 0.4")

#### Weight

HP 11667A net, 0.14 kg (0.31 lb); shipping 0.22 kg (0.5 lb).

HP 11667B net, 0.06 kg (0.13 lb); shipping 0.14 kg (0.3 lb).

HP 11667C net, 0.06 kg (0.13 lb); shipping 0.14 kg (0.3 lb).

# NETWORK ANALYZERS

## Ordering Information

HP 8757

### Ordering Information

The HP 8757 Scalar Network Analyzer is ordered with multiple line items to give you maximum flexibility in specifying a system that meets your needs. This ordering guide lists the HP 8757 line items required for software compatibility. It is not necessary to order any line item you already own. Consult your local HP Sales Office if you would like assistance.

	Price		
<b>Complete measurement systems</b>			
HP 8757XA 20 GHz Coaxial Scalar System	\$38,940		
<b>Includes:</b>			
HP 8757C Scalar Network Analyzer			
HP 8350B Sweep Oscillator			
HP 83592C RF Plug-in (0.01 - 20 GHz)			
HP 85027E Directional Bridge (3.5 mm)			
HP 85025E Detector (3.5 mm)			
HP 85022A Cable Kit			
HP 8757XB 40 GHz Coaxial Scalar System	\$53,305		
<b>Includes:</b>			
HP 8757C Scalar Network Analyzer			
HP 8350B Sweep Oscillator			
HP 83597A RF Plug-in (0.01 - 40 GHz)			
HP 85027D Directional Bridge (2.4 mm)			
HP 85025D Detector (2.4 mm)			
HP 85022A Cable Kit			
<b>Analyzer</b>			
HP 8757C Scalar Network Analyzer	\$9,000		
Opt 001 Fourth detector input	+\$1,500		
Opt 802 HP 9122C Disk Drive and an HP 10833A HP-IB cable	+\$1,545		
Opt W03* 90 day on-site warranty conversion	\$0		
Opt W30 2 year extended service	+\$215		
HP 8757E Scalar Network Analyzer	\$7,500		
Opt W03* 90 day on-site warranty conversion	\$0		
Opt W30 2 year extended service	\$190		
<b>Sweep oscillators</b> (choose either HP 8350B with an RF Plug-in, 8360 Series, 8340B, or 8341B)			
<b>Directional bridges</b> (choose at least one)			
HP 85027A 0.01-18 GHz, 7mm, 50 ohm	\$2,600		
HP 85027B 0.01-26.5 GHz, 3.5mm female, 50 ohm	\$3,100		
HP 85027C 0.01-18 GHz, Type-N female, 50 ohm	\$2,600		
HP 85027D 0.01-47 GHz, 2.4mm male, 50 ohm	\$3,500		
HP 85027E 0.01-26.5 GHz, 3.5mm male, 50 ohm	\$3,050		
HP 85020A 0.01-4.3 GHz, Type-N female, 50 ohm	\$1,150		
HP 85020B 0.01-2.4 GHz, Type-N female, 75 ohm	\$1,300		
<b>Detectors</b> (choose at least one)			
HP11664A 0.01-18 GHz, Type-N male	\$550		
Opt 001 7mm connector	+\$50		
HP 11664E 0.01-26.5 GHz, 3.5mm male	\$700		
HP 11664D 26.5-40 GHz, WR-28 waveguide	\$1,250		
HP 11664C Detector Adapter	\$325		
HP 85025A 0.01-18 GHz, Type-N male	\$900		
Opt 001 7mm connector	+\$50		
HP 85025B 0.01-26.5 GHz, 3.5mm male	\$950		
HP 85025D 0.01-50 GHz, 2.4mm male	\$1,500		
HP 85025E 0.01-26.5 GHz, 3.5mm male	\$1,200		
		HP R85026A 26.5-40 GHz, WR-28 waveguide	\$1,550
		HP Q85026A 33-50 GHz, WR-22 waveguide	\$1,750
		HP U85026A 40-60 GHz, WR-19 waveguide	\$1,750
		HP 85025C Detector Adapter	\$600
		<b>System verification kits</b> (choose at least one)	
		HP 85028A 7mm directivity verification standards	\$5,000
		HP 85023A 7mm, 50 ohm	\$675
		HP 85023B 3.5mm, 50 ohm	\$900
		HP 85023C Type-N, 50 ohm	\$600
		HP 85023D Type-N, 75 ohm	\$950
		HP 85023F 2.4mm, 50 ohm	\$2,100
		<b>Filter kits</b>	
		HP 11668 High Pass Filter Kit	\$650
		HP 11678 Low Pass Filter Kit	\$2,125
		<b>System cable kit</b>	
		HP 85022A System Cable Kit	\$355
		<b>Computer</b>	
		HP 98580C Option 102 Series 300, Model 332	\$6,720
		<b>Disk drive</b>	
		HP 9122 3.5 inch Dual Flexible-disk Drive	\$1,425
		<b>Software</b> (choose one option)	
		HP 85015B System Software for HP 8757	\$2,000
		Opt 630 for Computer with HP 9121/22 Disc Drive	\$0
		Opt 655 for either HP 9826 or 9836 Computer	\$0
		HP 85016B Transmission Line Test Software for HP 8757	\$4,500
		Opt 630 for Computer with HP 9121/22 Disc Drive	\$0
		Opt 655 for either HP 9826 or 9836 Computer	\$0
		HP Part No. 86399-10001 Amplifier Test Software	\$250
		<b>Recommended accessories</b>	
		<b>Printer</b> (choose at least one)	
		HP 2225A ThinkJet Printer	\$495
		HP 2227B QuietJet Printer	\$775
		HP 3630A Option 002 PaintJet Color Graphics Printer	\$1,275
		<b>Plotter</b> (choose at least one)	
		HP 7440A Opt 002 Eight-pen Graphics Plotter (8.5" x 11")	\$1,275
		HP 7550 Eight-pen Vector Plotter (11" x 17")	\$3,945
		<b>Optional accessories</b> (for ratio and/or modulation measurements)	
		HP 11636A Power Divider dc to 18 GHz	\$550 ☎
		HP 11636B Power Divider dc to 26.5 GHz	\$995
		HP 11665B Modulator	\$950 ☎
		HP 11667A Power Splitter dc to 18 GHz	\$930
		Opt 001 N-male on input port; N-female on output ports:	\$0
		Opt 002 N-female on input port; 7mm on output ports:	+\$75
		HP 11667B Power Splitter dc to 26.5 GHz	\$995
		HP 11667C Power Splitter dc to 50 GHz	\$1,500
		HP 11852B 50 to 75 ohm Minimum Loss Pad	\$350
		<b>Service and Support Products</b>	
		HP 11613B Calibrator	\$995
		HP 415E SWR Meter	\$2695
		Opt 001 rechargeable battery installed	+\$105
		Opt 002 rear panel output connector	+\$25
		HP Part No. 08757-60101 Retrofit Kit, Add option 001 (fourth detector input) to the HP 8757C	\$1,500

\* Only where available

☎ For same-day shipment, call HP DIRECT at 800-538-8787

# NETWORK ANALYZERS

## Scalar Network Analyzer Software for the HP 8757/8756

HP 85015B, 85016B, 86399-10001

- Custom tests without programming
- Friendly menu operation
- Measure insertion and return loss

- Plot or store data
- Test coax and waveguide
- Locate faults in transmission lines

### HP 85015B System Software

Using the HP 85015B system software for the HP 8757/8756, you can create and run complete scalar measurements without programming. The software guides you all the way from setup to output. Just make your selections using the computer's knob and softkeys. The software makes all the necessary settings on the scalar analyzer and source to provide fast, accurate measurements that can be stored for later reference.

### Easy To Learn

Use the BASIC mode to get up to speed quickly on the software's operation. It prompts you with a few simple questions, then sets up your source and analyzer automatically. The software prompts you to make all the connections necessary for calibration and measurement sequences, then automatically plots the data on the CRT display. For a permanent record, send the plot to a graphics plotter with a single keystroke.

### Use The Analyzer CRT

With the HP 8757, use the scalar analyzer as the control center for your measurements. The analyzer knob and softkeys control the software menus which appear on the CRT of the HP 8757, instead of the computer's.

### Customized Measurement Setups

Use the GENERAL and ADVANCED modes to access more of the software's powerful features. Define up to 4 measurements in one sequence. Specify particular power levels for your test device and enter your specification limits as point, line, or sloped limits. These limit lines allow simple pass/fail testing, or real time adjustment to within the spec limits.

Then output the data using your own customized format with labels, limit lines and "out-of spec" indicators. Make up to 4 plots on a single page. Store the data on computer disc for archival purposes, then recall it later for further analysis.

The software makes it easy to save your configuration, complete with all the parameters you've specified and the calibration data. When you want to run this test later, just recall the configuration and connect the device. The software recalls cal data, plot formats, labels, limit lines . . . everything you need to run complete automated tests.

### Test Transmission Lines

The HP 85016B transmission line test software provides all the capability of the HP 85015B plus fault location for complete testing of coax and waveguide transmission lines. Test frequency response (insertion and return loss), then find faults (mismatches) that affect the signals in your frequency range. Troubleshoot your ECM, radar or communication system quickly and without guesswork.

Fault location is accomplished using frequency domain reflectometry, a technique that uses frequency domain reflection data and the inverse Fast Fourier Transform to characterize reflection as a function of distance. This enables you to locate impedance mismatches resulting from bad connections or faulty cables.

MISMATCH SUMMARY		Measurement 1:	
Cable or Waveguide Type: Coax	Relative Velocity: .695	Distance	FLT. R.L.
Loss/100 ft: 50	Length (Range): 10 ft	(ft)	A (dB)
Center Frequency: 5 GHz	Distance Resolution: .1 ft	.020	21.91
Current Window is: Normal		4.120	26.84
		7.920	20.44
			% OF TOTAL MISMATCH
			36.347
			20.607
			43.046

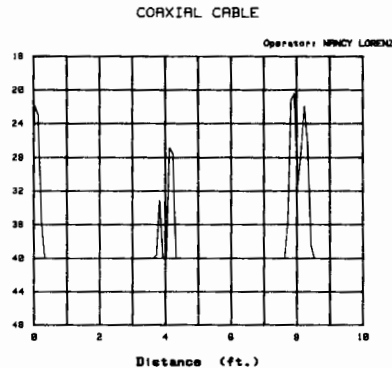

### Compatible Sources

The HP 85015B and 85016B software are compatible with HP 8757 or 8756 scalar network analyzer systems configured with an HP 8350B sweep oscillator and HP 83500 series RF plug-in or an HP 8340B or 8341B synthesized sweeper. The HP 85015B and 85016B software are not compatible with systems configured with an HP 8360 series synthesized sweeper.

### Ordering Information

Each software package comes with 5 discs, including a data disk. Order the option that corresponds to your computer configuration. The HP 85015B/16B can run on BASIC 3.0 or greater and requires 1 1/2 Mbytes of RAM memory.

	Price
HP 85015B system software	\$2000
Opt 630 3.5 inch disks	\$0
Opt 655 5.25 inch disks	\$0
HP 85016B transmission line test software	\$4500
Opt 630 3.5 inch disks	\$0
Opt 655 5.25 inch disks	\$0

### Amplifier Test Software

#### Tailored for Amplifier Testing

The Amplifier Test Software (HP Part No. 86399-10001) allows rapid and systematic characterization of amplifier gain compression. Specifically, the software automates measurements of amplifier output power at the 1-dB compression point at frequencies of interest. The software runs with the HP 8757A/HP 8757A/C and 8756A, and the HP 8350B sweep oscillator or HP 8340B/41B synthesized sweepers. Besides compression testing, the software also allows measurements of gain and return loss/SWR.

#### Easy to Operate and Modify

The Amplifier Test Software's menu-driven, friendly user interface is designed so that measurements can be configured and run soon after the system is set up. Its limited feature set allows for a short program, which can be easily modified by the user to suit his needs. The documentation provided with the software includes a complete program listing, flow diagram, and variable dictionary.

### Ordering Information

Each software package comes with the software on both 3-1/2" and 5-1/4" formats, and Product Note 8757-6, which documents operation of the software. The Amplifier Test Software can run on BASIC 3.0 or higher on HP 9000 series 200 or 300 computers with at least 1 Mbyte of RAM memory.

HP 86399-10001 Amplifier Test Software	\$250
--	-------

### Automate your measurements with a PC

Access popular DOS programs and control your measurement system with a personal computer. Run the HP 85015B, 85016B or your own HP BASIC measurement program on the HP Vectra personal computer by adding an HP 82300B HP BASIC Language Processor.

# NETWORK ANALYZERS

## Transmission Line Test System

HP 8328A

- High resolution - 0.25%
- Fast computation
- Three user levels

- Automatic data correction
- Completely self-contained
- Pass/fail and limit testing

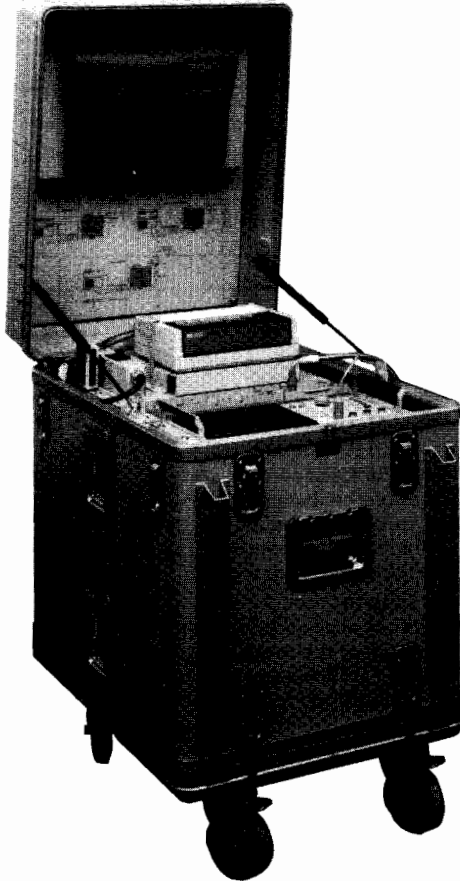

HP 8328A

The HP 8328A Transmission Line Test System tests the performance of waveguide runs and coaxial cables with swept frequency measurements of insertion loss and return loss. Additionally, the HP 8328A system can make fault location tests to find impedance mismatches as a function of distance, quickly and without guesswork.

The HP 8328A is a dedicated transmission line test system for tests from 10 MHz to 18 GHz. It is configured in a rugged, transportable container. The system is self-contained for ease of use and is ideal for accessing transmission lines in difficult-to-reach installations such as aircraft. Although all testing can be done automatically, full manual capability is retained.

The HP 8328A contains the HP 8757C Scalar Network Analyzer, the HP 8350B Sweep Oscillator with the HP 83592A RF Plug-In for coverage from 10 MHz to 18 GHz, the powerful HP 9000 Model 332 computer, the HP 85016B Transmission Line Test Software, and scalar analyzer accessories. The software is accessed from the front panel softkeys and knob of the HP 8757C. Complete measurements including pass/fail and limit testing can be configured and run easily like the HP 85016B software.

It is recommended that the HP 8328A Option 100, an HP 35741B monitor, an HP 46021A keyboard, and an HP 9122C dual disc drive be included for system diagnostics and disc backup for long-term data storage and retrieval.

### Swept Distance Capability

**Measurements vs. distance:** Return loss (dB), SWR, or reflection coefficient.

**Resolution** (distance between data points as a percentage of the transmission line length):

1% (101 pts), 0.5% (201 pts), 0.25% (401 pts).

**Data correction:** Data is normalized to the response with a 50 ohm load at the test port. Data is also completely corrected for line losses and preceding mismatches. If waveguide is tested, the effects of phase dispersion are automatically removed from the response. The correction data for the coaxial cable or waveguide run is contained in a lookup table with over 100 entries stored in the program. This table can be modified to improve entries or updated with new cables.

**Range and resolution (vs. frequency):** The standard RF plug-in for the system is an HP 83592A, with a span from 10 MHz to 18 GHz. This span allows a minimum test range of 2 ft. and a resolution of 0.01 ft. (for 201 distance points and 0.5% resolution). Maximum test range is 500 ft. with a resolution of 2.5 ft.

### Swept Frequency Capability

**Measurements vs. frequency:** Insertion loss, gain, return loss, VSWR, reflection coefficient, and power in dBm, dBW, or mW.

**Frequency range:** 10 MHz to 18 GHz with HP 83592A plug-in; Option 001, 10 MHz to 8.4 GHz with HP 83525B plug-in

**Resolution:** User selectable up to 1024 pts. for swept measurements, or stepped CW measurements.

**Dynamic range (HP 11664A detectors and HP 8757C):** 76 dB (+16 to -60 dBm)

### General

**User modes:** BASIC, GENERAL, and ADVANCED. These user levels vary the level of sophistication to match the experience level of the user and the requirements of the measurement.

### Measurement and data storage:

**Configurations per data volume (typical): 99**

**Measurements per configuration: 4**

**Measurement data sets per data volume: 99**

Additional storage can be obtained with the HP 8328A option 100 and the recommended optional equipment.

### Ordering Information

HP 8328A Transmission Line Test System	\$64,830
Opt 001 10 MHz to 8.4 GHz only	-\$4,295
Opt 100 Adds support software	+\$250
Opt W30 Extended repair service see page 723	+\$1,600
Opt 043 Add floppy disk drive	+\$500

# NETWORK ANALYZERS

## Audio/Video/Baseband/IF Network Analyzer, 5Hz to 200 MHz

### HP 3577B

229

- High-speed/high accuracy measurements
- .001 dB, .005 degree, 1 ps and .001 Hz resolution
- Discrete sweep and limit lines
- Optional HP Instrument BASIC

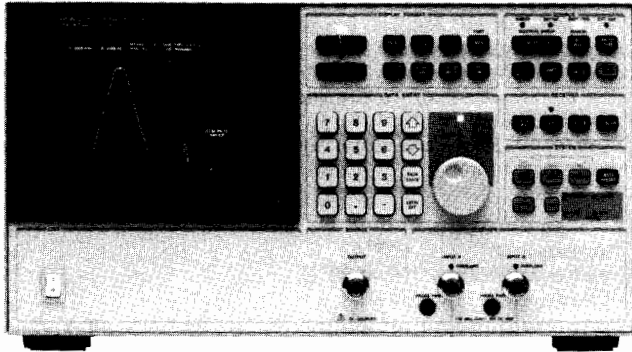

HP 3577B



### HP 3577B Network Analyzer

The HP 3577B is a high-performance, yet economical, two-channel network analyzer for use in both R&D and manufacturing. It is used to measure magnitude/phase, insertion loss, group delay, SWR, electrical length, and gain compression from 5 Hz to 200 MHz. When used with the HP 35676A/B reflection/transmission kit, it can also measure return loss, reflection coefficient and impedance.

An optional third channel is available for use with the HP 35677A/B s-parameter test set or for measuring two devices simultaneously. When used with the HP 35677A/B, the HP 3577B can measure all four s-parameters and any of the parameters listed above without having to manually alter the test configuration. The HP 35677A is used for 50 ohm systems and the HP 35677B is used for 75 ohm systems.

When equipped with optional HP Instrument BASIC, the HP 3577B can execute user-written programs designed to automate measurement systems, compute parameters (such as pass band ripple and 3 dB bandwidth) or customize the user-interface. This includes system control of other HP-IB instruments and peripherals, such as plotters and printers, via the HP-IB. A programmable I/O port, located on the rear panel, extends HP Instrument BASIC control to non HP-IB devices, such as device handlers, environmental chambers and even the device-under-test itself.

Of course, the HP 3577B is fully programmable, either internally with HP Instrument BASIC, or externally via the Hewlett-Packard Interface Bus (HP-IB).

An optional high-stability frequency reference oven is available for those users not having an in-house frequency standard.

### Unprecedented Measurement Precision

This network analyzer has the accuracy and resolution required to characterize the most demanding narrowband devices and the flexibility to quickly characterize wideband devices. Dynamic magnitude and phase accuracy are 0.02 dB and 0.2 degree, respectively. Device response can be examined in fine detail with 0.001 dB, 0.005 degree, and 1 ps resolution. A built-in synthesized LO and tracking generator provide superb frequency accuracy with 0.001 Hz resolution. The 100 dB plus dynamic range and -130 dBm noise floor meet the needs of the most demanding measurements.

Built-in three-term error correction removes errors due to directivity, frequency response, and source mismatch for one-port measurements. Similarly, vector normalization enhances the accuracy of two-port measurements.

### High-Throughput for Manufacturing

The HP 3577B brings high-throughput network analysis to manufacturing without compromising accuracy. Using discrete sweep, the sweep time is typically reduced by a factor of twenty when compared to a traditional linear sweep. Operators select from 2 to 51 frequency points for measurement. High-frequency resolution is used only in important regions of the device response; less important regions are measured with few points or skipped completely. Sweep time is further reduced by selecting the optimum resolution bandwidth and settling time for each frequency point.

Evaluation of test results is completed in a tenth of a second using the limit test feature. Any combination of upper and lower limits, with up to 20 operator-defined segments, is allowed. Test results are compared to the limits at the end of each sweep, and PASS/FAIL is indicated both on the display and on the FAIL line of programmable I/O port.

Optional HP Instrument BASIC completes the high-throughput picture by providing fast, error-free instrument/test system configuration and control of non HP-IB devices, such as device handlers.

### Specifications Summary

#### Source

##### Frequency

Range: 5 Hz to 200 MHz.

Resolution: 0.001 Hz

Stability (opt 1 only/instrument on  $\geq$  48 hrs):

$\pm 5 \times 10^{-8}$ /day, 0 to 55°C.

##### Amplitude

**Range:** +15 dBm to -49 dBm (1.26 Vrms to 793  $\mu$  Vrms: 2dBV to -62 dBV) into a 50 $\Omega$  load.

**Resolution:** 0.1 dB

**Accuracy:**  $\pm 1$  dB at +15 dbm and 100 kHz. Below +15 dBm, add the greater of  $\pm 0.02$  dB/dB or 0.2 dB.

**Flatness:** 1.5 dBp-p from 5 Hz to 200 MHz.

**Impedance:** 50 $\Omega$ ;  $> 20$  dB return loss at all levels.

**RF output connector:** 50 $\Omega$  Type N female.

**Sweep types:** linear, discrete, alternate, cw and log frequency; log amplitude.

**Sweep time:** 100 ms/span to 6553 sec/span for frequency sweep; 1 ms/step to 16 s/step for amplitude sweep.

**Sweep modes:** continuous, single, manual.

**Trigger modes:** free run, immediate, line, external

#### Input Characteristics

**Frequency range:** 5 Hz to 200 MHz.

**Inputs:** two receiver inputs (A,R); third receiver input (B) is optional

**Input impedance:** selectable 50 $\Omega$  with  $> 25$  dB return loss, or 1 M $\Omega$  in parallel with approximately 30 pF.

**Input connectors:** 50 $\Omega$  Type N female.

**Full scale input level:** -13 dBV from 10 kHz to 200 MHz with internal 20 dB attenuators ON (0 dBm at 50 $\Omega$ ).

**Resolution bandwidth:** selectable 1 kHz, 100 Hz, 10 Hz, or 1 Hz.

**Sensitivity** (Due to noise and internal crosstalk between source and receiver inputs):

	30 kHz-200 MHz (50 $\Omega$ )	300 kHz-20 MHz (1M $\Omega$ )
	Internal 20 dB Attenuator ON	Internal 20 dB Attenuator OFF
Resolution	-110 dBm	-130 dBm
Bandwidth	-105 dBm	-125 dBm
10 Hz	-95 dBm	-115 dBm
100 Hz		
1 kHz		

Crosstalk:  $> 100$  dB isolation between inputs.  
For 1 M $\Omega$  inputs, add 5 dB to table.

### Magnitude characteristics

**Range:** full scale input to sensitivity.

**Display units:** dB, dBm, dBV, V, and linear ratio.

**Accuracy** (at 100 kHz, 25°C, and full scale input)

Absolute (A, B, R):  $\pm 0.2$  dB.

Ratio (A/R, B/R, A/B):  $\pm 0.15$  dB (50 $\Omega$ );  $\pm 0.2$  dB (1 M $\Omega$ ).

# NETWORK ANALYZERS

## Audio/Video/Baseband/IF Network Analyzer, 5 Hz to 200 MHz (cont'd)

### Dynamic Accuracy

Error		Input Level Relative to Full Scale Input
Resolution Bandwidth		
1 kHz, 100 Hz, 10 Hz	1 Hz	
±.04 dB	±.04 dB	0 dB to -10 dB
±.02 dB	±.02 dB	-10 dB to -50 dB
±.05 dB	±.05 dB	-50 dB to -60 dB
±.15 dB	±.25 dB	-60 dB to -80 dB
±.75 dB	±.75 dB	-80 dB to -90 dB
±.75 dB	± 3.00 dB	-90 dB to -100 dB

**Frequency response** (when driven from a 50Ω source and with 50Ω receiver input impedance)

Absolute (A,B,R): 0.3 dBpp from 20 Hz to 20 MHz; 0.6 dBpp from 5 Hz to 200 MHz.

Ratio (A/R, B/R, A/B): 0.3 dBpp from 20 Hz to 20 MHz; 0.4 dB from 5 Hz to 200 MHz.

### Stability

Temperature: typically  $< \pm 0.02$  dB/°C.

Time: typically  $\pm 0.05$  dB/hour at 25°C.

### Phase characteristics (A/R, B/R, A/B)

**Range:**  $\pm 180$  degree.

**Accuracy:** At 100 kHz, 25°C, and Full Scale Input:  $\pm 2.0^\circ$ .

### Dynamic Accuracy

Error	Input Level Relative to Full Scale Input
±.4 degree	0 dB to -10 dB
±.2 degree	-10 dB to -50 dB
±.5 degree	-50 dB to -60 dB
±1.5 degree	-60 dB to -80 dB
±7.5 degree	-80 dB to -100 dB

**Temperature stability:** typically  $< \pm 0.05$  degree/°C.

**Time stability:** typically  $< \pm 0.05$  degree/hr at 25°C.

### Delay characteristics

**Range:** 1 ps to 20,000s.

**Resolution:** 0.01 ns/div to 1000s/div.

**Normalized accuracy:**  $\frac{\text{Dynamic Phase Accuracy}}{360 \times \text{Aperture [Hz]}}$  +2ns

**Aperture range:** 0.5% to 16% of frequency span.

**Reference level:**  $\pm 10_3$  s.

**Limit test:** Twenty segments for each trace per limit test. Delay between sweeps approximately 10 to 120 ms.

### General Characteristics

#### Traces

**Number of traces:** two simultaneous traces may be present with a rectangular graticule. One trace with polar or Smith graticules.

**Markers:** each trace has one main marker and an offset marker.

#### Graticules

**Rectangular graticule:** 0% to 100% full scale deflection in 0.05% increments. Logarithmic and linear.

**Polar/Smith chart graticule:**  $\pm 500$  degree in 0.001 degree increments.

#### Limit test

Twenty segments for each trace per limit test. Delay between sweeps approximately 10 to 120 ms.

#### Noise averaging

**Type:** exponentially weighted vector averaging on successive sweep data.

**Averaging factor:** selectable 1 (off), 4, 8, 16, 32, 64, 128, 256.

**Linear phase slope compensation:** Provides linear phase slope offset of  $-72,000$  degree/span to  $+72,000$  degree/span.

### Calibration

**Transmission:** Both traces can be normalized to measured data with full accuracy and resolution.

**Reflection:** Corrects for directivity, frequency response and source match errors.

### Programming

**Remote programming** via the Hewlett-Packard Interface Bus (HP-IB). The HP 35677A/B S-parameter test sets are programmable through the HP 3577A interface only.

**Plotter control:** directly compatible with HP-IB graphics plotters that use Hewlett-Packard Graphics Language (HP-GL) with listen-only capability.

**Save/recall:** front-panel setups can be stored in non-volatile memory locations 1 through 5. Last state is saved when power is removed.

### Operating conditions

**Temperature:** 0°C to +55°C.

**Relative humidity:** <95% at 40°C.

**Altitude:** <4,572m (15,000 ft).

### Non-operating conditions

**Temperature:** -40°C to +75°C.

**Altitude:** <15,240m (50,000 ft).

**Power:** 115V + 10%, -25% (47 Hz to 440 Hz), or 230 V + 10%, -15% (47 Hz to 66 Hz), 450 VA maximum.

**Weight:** 31 kg (67 lb) net; 41 kg (90 lb) shipping.

**Size:** 222H x 426W x 578 mmD (8.7" x 16.75" x 22.75").

### HP 35677A/B S-Parameter Test Set

The HP 35677A/B test set is used to make transmission and reflection measurements in both the forward and reverse directions. The only setup required is to connect the device-under-test to the two measurement ports. Even reverse measurements can be made without changing device connections. The HP 35677A is used for 50-ohm systems and the HP 35677B is used for 75-ohm systems.

### HP 35677A/B S-Parameter Test Set Specifications

**Frequency range:** 100 kHz to 200 MHz.

**Test port impedance**

HP 35677A: 50Ω; HP 35677B: 75Ω

**Directivity:** >40 dB.

**Frequency response**

**Transmission (S21, S12):**  $\pm 1$  dB,  $\pm 5$  degrees.

**Reflection (S11, S22):**  $\pm 1$  dB,  $\pm 5$  degrees.

#### Port match

**Test ports 1, 2:** HP 35677A, > 26 dB; HP 35677B, >24 dB.

**Test ports 1, 2 open/short ratio:** HP 35677A,  $< \pm 0.75$  dB magnitude and  $< \pm 5$  degrees phase; HP 35677B,  $< \pm 1$  dB magnitude and  $< \pm 7.5$  degrees phase.

**Input port:** >20 dB return loss.

**Output ports A, B, and R:** >26 dB return loss.

**Test port isolation:** > 100 dB.

#### Connectors

**Input port and output ports A, B, and R:** 50Ω Type N female. Test Ports 1 and 2: HP 35677A, 50Ω Type N female; HP 35677B, 75Ω Type N female.

**dc bias inputs:** BNC female, rear panel.

**dc bias range:** Typically  $\pm 30$  Vdc and  $\pm 20$  mA with some degradation of RF specifications; 200 mA damage level.

### Accessories Supplied

4 ea. 190 mm (7.5") 50Ω cables with type N male connectors for connection to HP 3577B (HP 8120-4387)

1 ea. test set interconnect cable to HP 3577B (HP 35677-61620)

1 ea. Rear-panel lock foot kit (HP 5061-0099).

1 ea. Service manual (HP 35677-90010).

# NETWORK ANALYZERS

## Audio/Video/Baseband/IF Network Analyzer, 5 Hz to 200 MHz

HP 3577A, 3575A

231

### General Characteristics

**Power:** all power is obtained through the HP 35677A interconnect cable.

**Weight:** net, 6 kg (13 lb); shipping, 122 kg (25 lb)

**Size:** 90H x 425W x 584 mmD (3.5" x 16.75" x 22.75"). Add 1 1/8 inch to depth for front panel connectors.

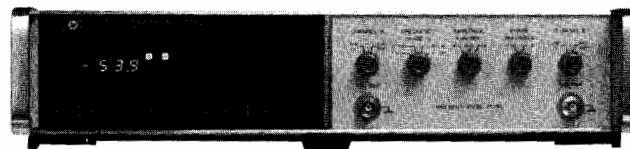

HP 3575A

### HP 35676A/B Reflection/Transmission Test Kits

Operating in conjunction with internal calibration routines in the HP 3577B, the HP 35676A/B test kit provides measurements of reflection, transmission and impedance from 5 Hz to 200 MHz. Each test kit contains a precision resistive divider, a reference load, a coaxial short, a carrying case, and miscellaneous cables and hardware.

### HP 35676A/B Operating Characteristics\*

**Frequency range:** 5 Hz to 200 MHz.

**Test port impedance:** 50Ω ± 2% typical (HP 35676A) 75Ω ± 2% typical (HP 35676B).

**Equivalent directivity:** 40 dB typical.

**Equivalent source match:** 30 dB typical (HP 35676A); 25 dB typical (HP 35676B).

\*Typical, assuming proper calibration with accessories supplied.

### HP 3575A Gain-Phase Meter

The HP 3575A gain-phase meter is a broadband two-channel analyzer typically used to measure transfer functions such as amplifier gain/loss or the frequency response of filters. It can be used to measure the ratio and relative phase of any two signals on its two-channel inputs and for absolute measurements of signals on each channel. A wide range of input waveforms can be measured, including sine, square, and triangular waveforms. A three-digit display can be selected to read amplitude level/ratio or phase of the input signals. An optional three-digit readout and analog output is available for simultaneous amplitude and phase measurements.

### Specifications Summary

**Frequency:** 1 Hz to 13 MHz.

**Level:** 200 μV rms to 20 V rms.

**Number of channels:** 2.

**Impedance:** 1 MΩ in parallel with 30 pF.

**Protection:** ± 40 V dc, 20 V rms.

**Nominal amplitude accuracy:** ±1 dB (See data sheet for complete accuracy specifications)

**Amplitude functions:** A dBV, B dBV or B/A dB.

**Range:** A dBV, B dBV: -74 dBV to +26 dBV (in two ranges). B/A dB: -100 to +100 dB.

**Resolution:** 0.1 dB.

**Nominal phase accuracy:** ±0.5 degrees (See data sheet for complete accuracy specifications)

**Range:** ±180° with 12° of overrange.

**Resolution:** 0.1°

### General

**Power:** 115 V / 230 V ±10%, 48 Hz to 440 Hz, 40 VA.

**Weight:** net, 8.3 kg (18.4 lb); shipping, 11.3 kg (25.8 lb)

**Size:** 88 H x 425 W x 337 mm D (3.47" x 16.75" x 13.25")

Contact your local HP sales office for more information including a data sheet containing complete specifications.

### HP 35675A Accuracy Enhancement Software

The HP 35675A Accuracy Enhancement Software is an excellent beginning for computer-based automated network analysis measurements. It provides two-port, 12-term error correction, conversion from s-parameters to h, y or z parameters, and computer-based autosequence instrument operation.

Contact your local HP sales office for more information including a data sheet.

### Ordering Information

	<b>Price</b>
HP 3577B network analyzer	\$18,950
Opt 001 Frequency reference	+\$850
Opt 002 Third receiver	+-\$3,450
Opt 1C2 HP Instrument BASIC/ 64 Kbytes RAM	+\$950
Opt 907 Front handle kit	+\$79
Opt 908 Rackmount kit	+\$42
Opt 909 Rackmount and front handle kit	+\$105
Opt 910 Extra operating and service manual	+\$250
Opt 911 Extra HP Instrument BASIC manual	+\$10
Opt W30 Extended repair service. See page 723	+\$450
HP 35675A accuracy enhancement software	\$1,700
Opt 042 software on 5 1/4 inch disks	\$0
Opt 044 software on 3 1/2 inch disks	\$0
HP 35676A 50Ω reflection/transmission test kit	\$1,400
Opt W30 Extended repair service. See page 723	+\$120
HP 35676B 75Ω Reflection/transmission test kit	\$1,675
HP 35677A 50Ω S-parameter test set	\$4,190
HP 35677B 75Ω S-parameter test set	\$4,190
Opt 907 Front handle kit	+\$52
Opt 908 Rackmount kit	+\$27
Opt 909 Rackmount and front handle kit	+\$63
Opt 910 Extra operating and service manuals	+\$47
HP 35678A 50Ω type N calibration kit	\$825
HP 35678B 75Ω type N calibration kit	\$1,575
HP 35679A 50Ω type N port extension cables	\$1,850
HP 35679B 75Ω type N port extension cables	\$1,700
HP 85024 high-frequency probe	\$1,900

### Ordering Information

	<b>Price</b>
HP 3575A Gain/Phase Meter	\$6,420
Opt 001 Dual readouts/dual outputs	+\$670
Opt 002* BCD programming (negative true)	+\$1,135
Opt 003* BCD programming (positive true)	+\$1,135
Opt 908 Rack flange kit	+\$37
Opt 910 Extra manual	+\$53
Opt W30 Extended repair service. See page 723.	+\$145

\*Note: Includes option 001

# NETWORK ANALYZERS

## Combined Network/Spectrum Analysis, 10Hz to 500MHz

### HP 4195A

- Linear and non-linear device measurement and analysis
- High accuracy and resolution
- User functions
- Color graphics, graphics analysis and direct copy capability
- Direct save/recall with internal disc drive

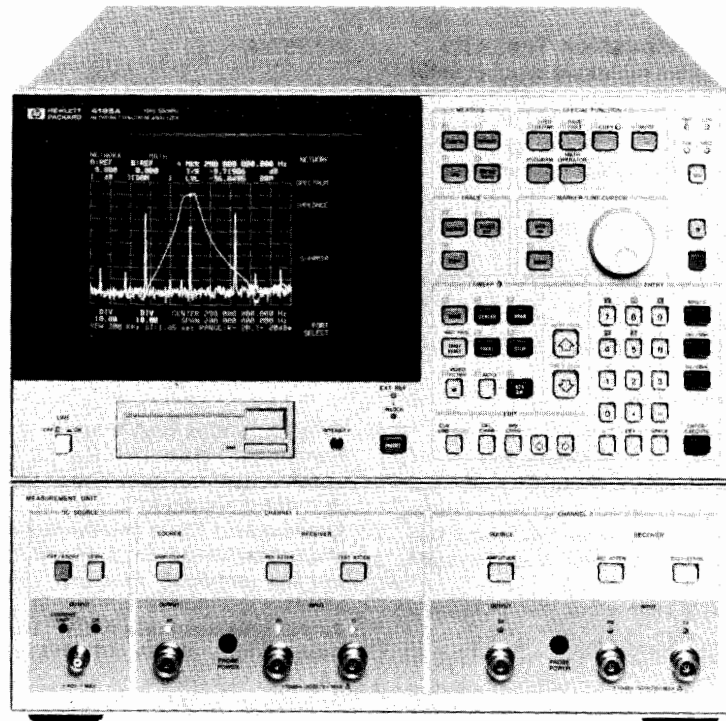

HP 4195A



### Description

The HP 4195A is a high performance, cost effective and intelligent analyzer with combined vector network and spectrum analysis capabilities. The frequency is covered from 10Hz through 500MHz with an excellent 0.001Hz resolution for audio, baseband, HF, VHF and IF applications. It directly measures amplitude ratio, phase, group delay and spectrum level needed for characterizing linear/non-linear analog circuits or components used in communications, telecommunications, consumer electronics and other equipment.

The HP 4195A's excellent accuracy and resolution meets the severe measurement requirements for developing advanced equipment. A color display allows you to readily differentiate between multiple traces. Convenient softkey operation and marker functions make deriving device parameters quick and easy. Measurement results can be directly copied to printer or plotter without an external computer. Furthermore, the HP 4195A has internal user functions for computing and self controlling capability. User Program, User Defined Function and User Math allows you to quickly customize the setups most suited to your application without using an external computer. A built-in 3.5 inch disc drive can save the instrument state, data and user functions.

### Combined Vector Network and Spectrum Analysis

Network analyzers and spectrum analyzers have become essential tools for evaluating subsystems or components used in electronic equipment. Especially, the importance of phase and group delay measurements is rapidly increasing. The HP 4195A offers full network and spectrum analysis from 10Hz to 500MHz at half the price. It has very wide applications. Network analysis functions include characterizing the gain/group delay ripple of filters and amplifiers. Spectrum

analysis functions include the harmonic, intermodulation distortion of amplifiers or IF subsystems in communications and telecommunications. S-parameters can also be measured by using 2 transmission/reflection test sets, without changing direction of the device.

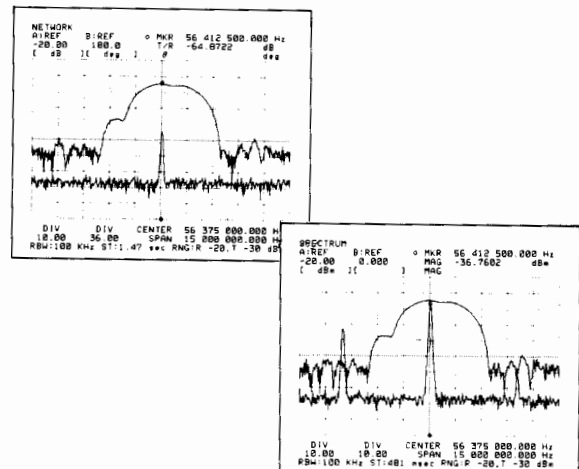



## High Accuracy and Resolution Measurement

The HP 4195A measures amplitude ratio and phase with an accuracy of  $\pm 0.05\text{dB}/\pm 0.3\text{ deg}$  and a resolution of  $0.001\text{dB}/0.01\text{ deg}$ . The amplitude and phase distortion of transmission devices, such as filters, amplifiers, delay lines and cables, affect the quality of information and create bit errors in PSK or QAM systems. The HP 4195A can evaluate distortion with high accuracy and resolution. For accuracy enhancement, 1 Port Full Cal, 1 Port Partial Cal, Normalization and Port Extension capabilities are available. For spectrum analysis, high level accuracy of  $\pm 0.1\text{dB}$  and fully synthesized pure local OSC, typically  $-100\text{ dBc/Hz}$  (100 Hz offset), allow you to obtain stable and reliable C/N, harmonic distortion or intermodulation distortion measurements. In addition the high shaped digital IF filter technique makes discrimination of closely spaced signals easy, so 50/60 Hz power-line sidebands can be measured using the 10Hz RBW.

## User Functions for Easy Customized Operation

The HP 4195A has three user functions for customizing operations for your applications without using an external computer. The User Program gives you a one key solution for performing your application. You can program a sequence from measurement and marker control, computing, through printing a hard copying. This function is very useful and improves efficiency for C/N (Carrier Noise ratio), THD (Total Harmonic Distortion) measurements or automatic device parameter extraction, such as an amplifier's gain, group delay, gain compression or harmonic distortion. The User Math function helps you put the result in the form you need by using the built-in math operators and arithmetic functions. For example, you can display level in volt peak-to-peak instead of volts rms or perform differentiation of gain or max hold. The User Defined Function gives you the power to define functions which can be called with softkeys as you like, such as input of step size, signal tracking, transmission/reflection alternate sweep or gain/level spectrum alternate sweep. In addition, the HP 4195A has the Program Sweep function which can arbitrarily sweep the points programmed in the table. This increases measurement efficiency by reducing excessive points in the Lin or Log sweep. Also, the resolution bandwidth can be independently set for each programmed point. The above user functions and program sweep table can be saved into the built-in 3.5 inch disc, so you can start your application at any time.

```

SPECTRUM      C/N-MEASUREMENT
PROGRAM EDITOR
FILE NAME: CNI

1  C/N-MEASUREMENT
10 ACQ2
20 DELT1
30 MKAC11
40 MKMK
50 DMKR=1 MHZ:R1=0
60 FOR R0=1 TO 10
70 SWT6
80 R1=DMKRA+R1

90 R0=R1*10
100 DISP "C/N(DB)="+R0
110 NEXT R0
120 GOTO C/N-MEASUREMENT
130 END
  
```

User Program for C/N Measurement

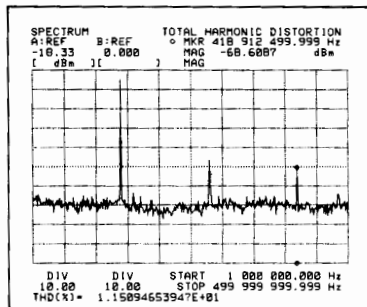

THD Measurement by Using User Define Function

## Advanced Marker Action on Color Graphics

The application oriented marker functions are very useful for both network and spectrum measurements. You can quickly obtain the desired results from the easy to see color graphics CRT. The Next Peak is convenient for searching harmonic or spurious signals. The marker target is used for extraction of SAW filter's 3dB bandwidth or an amplifier's  $-1\text{ dB}$  gain compression point. The delta marker is used for C/N measurement, and the noise marker is used for noise measurements. A maximum of four traces can be simultaneously displayed on the CRT, so it is easy to compare the data. The smith/polar chart is convenient for impedance matching in circuit design. In addition, the results can be directly copied to a compatible plotter or printer without an external computer.

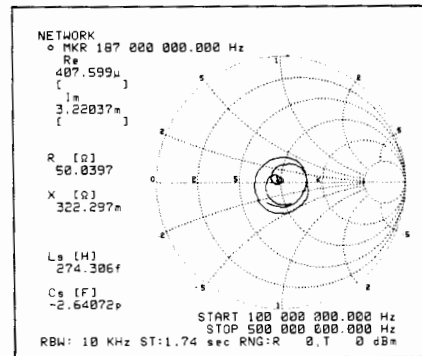

## Specifications

### Network Measurement

#### Source

**Frequency:** 10Hz to 500MHz, 1mHz resolution  
**Power:**  $-50\text{ dBm}$  to  $+15\text{ dBm}$ ,  $0.1\text{dB}$  resolution  
**Sweep Parameters:** Frequency, power and dc bias level  
**Sweep Types:** Linear, log, cw, program and partial  
**Output:** 2 outputs  
**DC bias level:**  $\pm 40\text{V}$ ,  $10\text{mV}$  resolution

#### Receiver

**Frequency:** 10Hz to 500MHz  
**Input:** 4 inputs,  $50\ \Omega$  nominal  
**Resolution Bandwidth:** 3Hz to 300kHz, 1 or 3 step  
**Input Crosstalk:**  $\leq -100\text{dB}$

#### Magnitude Ratio

**Dynamic Range:**  $> 100\text{dB}$   
**Resolution:**  $0.001\text{dB}$   
**Dynamic Accuracy ( $23 \pm 5^\circ\text{C}$ ,  $-30\text{dBm}$  R input):**  $\pm 0.05\text{dB}$  @  $-70\text{dBm}$  to  $-30\text{dBm}$  T input.

#### Phase

**Range:**  $\pm 180^\circ$   
**Resolution:**  $0.01^\circ$   
**Dynamic Accuracy ( $23 \pm 5^\circ\text{C}$ ,  $-30\text{dBm}$  input):**  $\pm 0.3^\circ$  @  $-70$  to  $-30\text{dBm}$  T input.

#### Delay

**Range:** 10ps to 500s  
**Resolution:** 10ps @ 3.6 MHz aperture  
**Accuracy:** depends on phase accuracy

#### Error Compensation

**Mode:** Normalization, 1 port partial cal, 1 port full cal and port extension.

### Spectrum Measurement

#### Frequency

**Measurement Range:** 10Hz to 500MHz  
**Resolution:**  
**RBW:** 3Hz to 300kHz, 1 or 3 step  
**Selectivity (60/3dB):** 4.5 for 3Hz to 30Hz, 9 for 100 Hz to 10 kHz,  
 8.5 for 30 kHz to 300 kHz.  
**Noise Sideband:**  $< -100\text{ dBc/Hz}$  @ 1 kHz offset  
 $< -90\text{ dBc/Hz}$  @ 100 Hz offset

# NETWORK ANALYZERS

## Combined Network/Spectrum Analysis, 10Hz to 500MHz (cont'd)

HP 4195A

### Amplitude

**Measurement Range:** -135 dBm to +20 dBm

**Accuracy:**  $\pm 1.0$  dB 50MHz

**Linearity** ( $23 \pm 5^\circ\text{C}$ ):  $\pm 0.1$  dB @ -40 to 0dB;  $\pm 0.2$  dB @ -60 to -40dB

**Frequency Response:**  $\pm 1.5$  dB

**Dynamic Range** ( $23 \pm 5^\circ\text{C}$ )

**Second Harmonic Distortion:**  $\leq -70$  dBc @  $\geq 2$  MHz

**T.O.I Distortion:**  $\leq -80$  dBc @  $\geq 2$  MHz

**Residual Response:** -110dB @  $\geq 100$  kHz.

**Average Noise Level:** typically -140dBm @ 10Hz RBW,  $\geq 2$  MHz

### Sweep

**Sweep Type:** Linear, log, cw, program and partial

**Sweep Mode:** Continuous, single and manual

**Sweep Time:** approximately 3.5 sec 500 MHz span, 300 kHz RBW

### Input

**Number of inputs:** 4 inputs

**Impedance:** 50  $\Omega$  nominal

**Damage level:** +30 dBm

**Attenuator:** 0 to 50dB, 10dB step

### Display and Analysis

**Display:** 7.5 inch color CRT

**Display Format:** Rectangulars, Table, Smith and Polar

**Traces:** 4 traces max

**Scale Type:** Linear, log

### Autoscale

**Phase Display Expansion:** Display phase continuously more than  $\pm 180$  deg.

**Video Filter:** Digital video filtering reduces random noise

**Comment Entry:** Display a comment used alphabet, numeral and special characters ( , , % , etc).

**Marker:** MKR  $\rightarrow$  Max (Min, Ref, Center, Start and Stop), Next Peak, Width and Delta reading mode.

### User Functions

#### User Math:

Puts the result in the form needed for your application by using built-in math operators, arithmetic functions and editing capability.

#### User Defined Function:

Provides one-key solution for a specific application without an external computer. 6 user functions can be created and soft-keys can be labeled as you like.

#### User Program (Auto Sequence Program):

Allows to program the control or measurement, analysis, copy and other sequence without an external computer.

### Hardcopy

Hardcopy of traces, measurement data, results of analysis and annotations are produced by the 4195A and HP plotters or printers with LISTEN only capability.

**Color Dump Mode:** Copy the traces, graticules and annotations to a color graphics printer. Colors are fixed.

**Dump Mode:** Copy the CRT display to a graphics printer

**Plot Mode:** Copy the traces, graticule and annotations to an HP-GL compatible digital plotter

**Print Mode:** Copy measurement data in tabular form to a printer

### Storage

Instrument state, trace data, table of Program Sweep and User Program can be independently saved or recalled from the built-in 3.5 inch floppy disk memory via SAVE/GET function.

Instrument state includes active control setting of measurement, active calibration data, active display format, active scale setting, User Math and User Define Function.

### Remote programming

HP-IB interface operates according to IEEE 488-1987 and IEC 625 standards and IEEE 628-1982 recommended practices

**Interface Function:** SH1, AH1, T5, TE0, L4, LE0, SR1, RL1, PP0, DC1, DT1, C0, E1

**Transfer Formats:** ASCII  
32/64 bit IEEE 754 floating point format

### General Characteristics:

#### Operating Conditions:

**Temperature:**  $0^\circ\text{C}$  to  $+45^\circ\text{C}$

**Humidity:** 95% RH at  $40^\circ\text{C}$

#### Non-Operating Conditions:

**Temperature:**  $-40^\circ\text{C}$  to  $+70^\circ\text{C}$

**Safety:** Based on IEC-348, UL-1244

**Power:** 100, 120, 220V  $\pm 10\%$ , 240V  $-10\%$   $+5\%$ , 48Hz to 60Hz, 500VA (max)

**Dimensions:** 425 (W) x 375 (H) x 620 (D) mm

**Weight:** Approximately 41kg

### 41951A Impedance Test Kit

The HP 4195A and HP 41951A Impedance Test Kit, which is designed to use with the 4195A, can be used to perform impedance analysis from 100kHz to 500MHz. The direct reading of impedance parameters, error compensation, variable test signal/dc bias level, and dedicated analysis functions are all convenient for evaluation of components, such as crystal/SAW resonators, coils, and varicap diodes. The equivalent circuit function is very useful for modeling and evaluating components under actual operating conditions to improve the quality and reliability of circuit design.

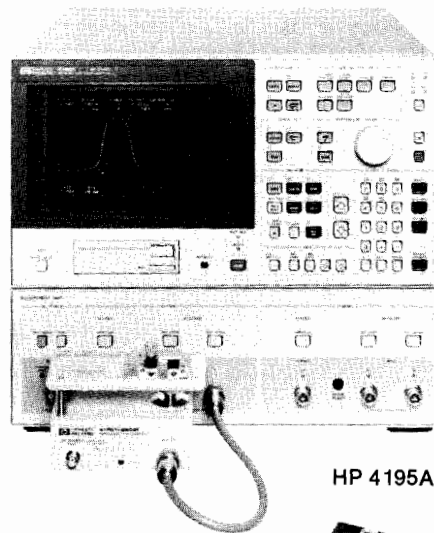

HP 4195A with HP 41951A



HP 41951A

**HP 41951A Impedance Test Kit**

The HP 41951A can be used for impedance measurements from 100kHz to 500MHz when used with the HP 4195A.

**Measured Parameters:** |Z|, |Y|,  $\theta$ , L, C, R, X, G, B, D, and Q

**Error Compensation:** 1 port cal, open/short offset and port extension

**Equivalent Circuit Analysis:** Circuit constants approximation and simulation of frequency characteristics

**Available Accessories:** Refer to page 301.

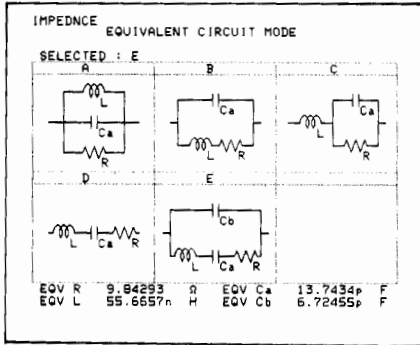

**41952A/B Transmission/Reflection Test Sets**

The HP 41952A/B Transmission/Reflection Test Sets provide a neat solution to the HP 4195A Network/Spectrum Analyzer to measure both transmission and reflection characteristics. The HP 41952A/B are directly connected to the HP 4195A and include a power splitter and a directional coupler in each compact box. Furthermore, two test sets of the HP 41952A or 41952B (opt. 009) allow the HP 4195A to perform full s parameters measurement without having to remove and reverse the device. The HP 41952A is used for 50 ohm application, and the HP 41952B is used for 75 ohm application.

**SPECIFICATIONS**

	HP 41952A	HP 41952B
Impedance:	50 ohm	75 ohm
Frequency Range:	100kHz - 500MHz	100kHz - 500MHz
Directivity:	40dB @300kHz-200MHz	35dB @300kHz-200MHz
Frequency Response: *1		
Transmission Magnitude, Phase (@ $\geq 300$ kHz)	$\pm 1$ dB, $\pm 5$ deg	$\pm 1$ dB, $\pm 5$ deg
Reflection Magnitude, Phase (@ $\approx 1$ MHz)	$\pm 1$ dB, $\pm 5$ deg	$\pm 1$ dB, $\pm 5$ deg
Effective Source Match:	$> 20$ dB @ $\geq 300$ kHz	$> 20$ dB @ $\geq 300$ kHz
Connector:		
Test Port:	50 ohm type N-(f)	75 ohm type N-(f)
Accessories Furnished:	50 ohm N cable Operating Note Carrying Case	50 ohm N cable HP 11852B M. L. Pad Operating Note Carrying Case

Note: HP 41952B opt. 009 deletes 50 ohm N cable and HP 11852B.

\*1: Typical



HP 4195A With HP 41952A



HP 41952A

**41800A Active Probe**

The HP 41800A Active Probe is a high input impedance probe which covers the frequency from 5Hz to 500MHz, and makes it easy to perform signal analysis of circuits in audio, video, HF and VHF band. For both spectrum and network analysis, the HP 41800A presents a great value by its low distortion and low noise characteristics. The HP 41800A is directly compatible with HP analyzers, such as the HP 4195A, HP 3577A, HP 3585A or HP 8568B, which supply probe power from the front panel.

**Specifications**

**Bandwidth:** 5Hz to 500MHz

**Input R, C (nominal):** 100k ohm, 3pF (probe alone)

**Average Noise Level (typical):** 10nV/ $\sqrt{\text{Hz}}$  300kHz to 500MHz

**2nd Harmonic Distortion:**  $< -50$ dBc  $-20$ dBc input

**Output Connector:** 50 ohm type N male

**Accessories Furnished:** 10:1 divider, hook tip, ground leads, spare tips, BNC male adaptor and so on



HP 41800A

**Accessories Available**

**HP 85044A/B Transmission/Reflection Test Set**

Refer to page 242.

**HP 85024A High Frequency Probe**

Refer to page 239.

**Ordering Information**

HP 4195A Network/Spectrum Analyzer

Opt W30 Extended repair service. See page 723

Opt 001 High Stability Frequency Reference Improve the stability of frequency for evaluation high Q devices such as crystal filter, oscillator or resonator.

Frequency Accuracy:  $\pm 1$  ppm ( $23^\circ\text{C} \pm 5^\circ\text{C}$ )

Frequency Stability:  $\pm 1 \times 10^{-8}$  ( $23^\circ\text{C} \pm 5^\circ\text{C}$ )

HP 41951A Impedance Test Kit

HP 41952A 50 $\Omega$  Transmission/Reflection Test Set

HP 41952B 75 $\Omega$  Transmission/Reflection Test Set

Opt 009 Delete 50 $\Omega$  N Cable and 11852B

HP 41800A Active Probe

**Price**

\$25,000

+\$575

+\$850

\$1500

\$2200

\$2700

-\$500

\$1700

# NETWORK ANALYZERS

## Baseband, IF and RF Network Analyzer, 5Hz to 500MHz

### HP 8751A

- 5Hz to 500MHz
- 0.001Hz, 0.001dB, 0.001 degree, 10ps resolution
- Full 2-port and interpolative calibration
- Conjugate matching analysis
- Built-in 1.44Mbyte disk drive for save/ recall
- Crisp color display with RGB output
- 10 updates of 201 sweep points per second
- 0.4ms/point fast list sweep
- Up to 4 traces simultaneous measurement/display
- 8 active trace markers per channel
- HP Instrument BASIC for customization
- HP 41802A 1M $\Omega$  input adapter

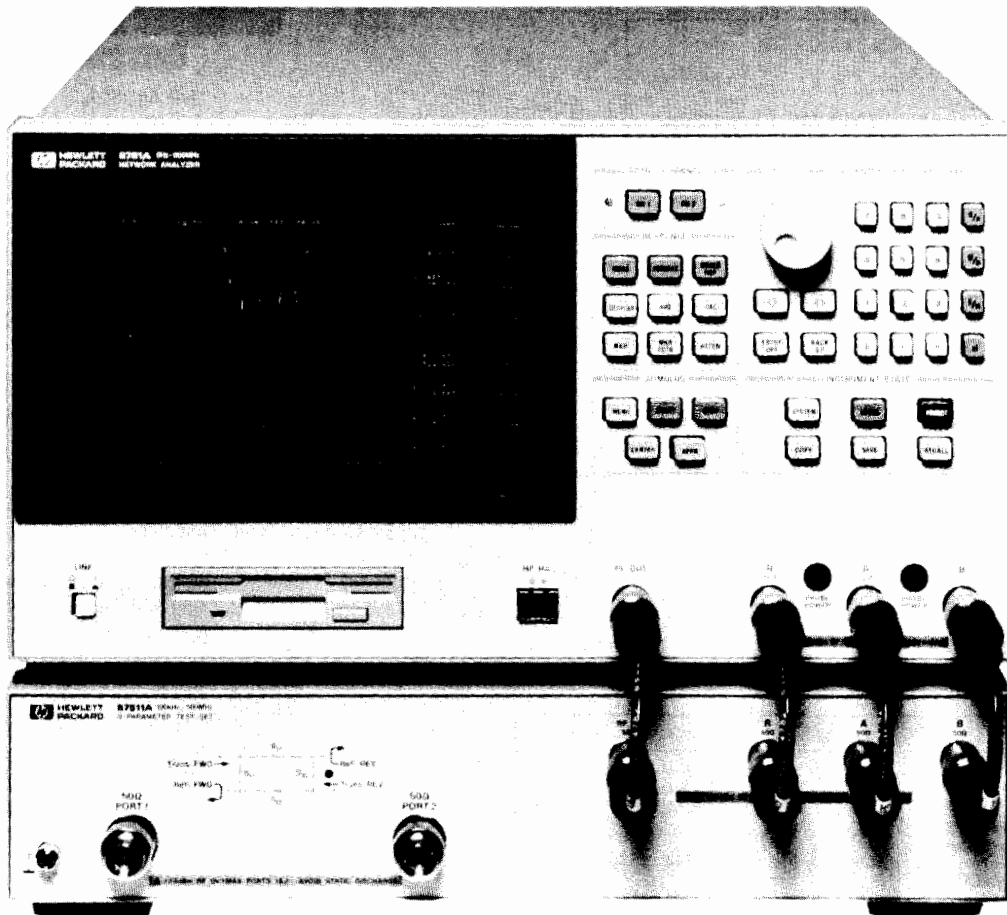

HP 8751A  
with HP 87511A

### HP 8751A Network Analyzer

The HP 8751A network analyzer is a high-throughput instrument with lab precision that covers 5Hz to 500MHz. The 8751A provides resolution of 0.001 Hz, 0.001 dB, 0.01 degree, and 10 ps for characterizing the linear behavior of either passive or active networks, devices, or components in the lab and the production test areas. The built-in 1.44Mbyte disk drive is for direct save/recall of instrument state, calibration data, and application programs for your customization. Dedicated 50/75 $\Omega$  S-parameter test sets, 50/75 $\Omega$  T/R test kits, and the 1M $\Omega$  input adaptors are all available.

### Lab Precision

Versatile display format and built-in accuracy enhancement (2-port full cal, 1-port full cal, and interpolative calibration) are provided for high-precision measurement in lab environments. The 8751As unique conjugate matching capability gives you the optimum power transfer to make designing easier.

### Production Throughput

Unprecedented total throughput is a key feature of the HP 8751A. 0.4 ms/point measurement time is now applicable not only to linear sweep but also to list sweep (programmable with IFBW and OSC output power) and to log sweep. The 8751A can also simultaneously measure/display up to four parameters with simple softkey operations. GO/NO-GO limit testing with an I/O handler control capability and HP Instrument BASIC are available to enhance total production test throughput.

### More Features

A 1.44Mbyte disk drive is standard with the 8751A for easy save/recall of the instrument states, calibration data, and application programs (HP Instrument BASIC). The HP 41802A 1 M $\Omega$  input adaptor also eases your high impedance measurement using 10:1 passive probes available for oscilloscopes.

### HP 8751A Specifications

#### Source

##### Frequency characteristics

**Range:** 5 Hz to 500 MHz

**Resolution:** 1 mHz

**Accuracy:**  $\pm 20$  ppm,  $\pm 1.0$  ppm (option 001)

**Stability:**  $\pm 2.5 \times 10^{-9}$ /8 hours (typical  $23 \pm 5^\circ\text{C}$  with option 001)

#### Output characteristics

**Power range:**  $-50$  to  $+15$  dBm

**Resolution:** 0.1 dB

**Flatness:**  $\pm 2.0$  dB @  $5 \text{ Hz} \leq \text{freq.} \leq 500 \text{ MHz}$   
( $23 \pm 5^\circ\text{C}$ ,  $+0$  dBm, relative to 50 MHz)

**Level accuracy:**  $\pm 0.5$  dB (50MHz, 0dBm)

**Level linearity:**  $\pm 0.5$  dB @ Output level  $\geq -35$  dBm  
 $\pm 1.5$  dB @  $< -35$  dBm

(50 MHz, relative to 0 dBm)

**Impedance:** 50 $\Omega$

**Receiver****Frequency range:** 5 Hz to 500 MHz**Input range:** 0 dBm @ ATT = 20 dB  
-20 dBm @ ATT = 0 dB**IF Bandwidth:** 2 Hz, 20 Hz, 200 Hz, 2 kHz, 8 kHz**Noise level:** -130 dBm @ IFBW=20 Hz, ATT=0 dB,  
frequency  $\geq$  100 kHz**Maximum input level:** 0 dBm**Impedance:** 50 $\Omega$ **Crosstalk:** <-100 dB**Dynamic accuracy:**  $\pm 0.05$  dB,  $\pm 0.3^\circ$  (Input level -10 to -60 dB,  
20 Hz IFBW)**Delay characteristics:****Aperture frequency:** 0.5 to 20%**Display range:** 10 ps to 500 s**Accuracy:** (Phase accuracy)/(360 x aperture)**Size:** 425W x 235H x 553mmD**Weight:** 28kg**HP 8751A Accessories****HP 87511A 50  $\Omega$  S-parameter Test Set****HP 87511B 75  $\Omega$  S-parameter Test Set**

The HP 87511A/B S-parameter test sets provide the capability to measure reflection and transmission characteristics (including S-parameters) of 2 port devices in either direction with a single connection. The frequency range of the HP 87511A/B test sets is 100 kHz to 500 MHz. The test sets are controlled from the HP 8751A.

**HP 87511A/B Specifications**

	HP 87511A	HP 87511B
Impedance	50 $\Omega$	75 $\Omega$
Frequency range	100 kHz - 500 MHz	100 kHz - 500 MHz
Directivity	$\geq 35$ dB from 300 kHz to 500 MHz	33 dB from 300 kHz to 500 MHz
Typical tracking S21, S12 S11, S22	$\pm 1$ dB, $\pm 5^\circ$ $\pm 1$ dB, $\pm 5^\circ$	$\pm 1$ dB, $\pm 5^\circ$ $\pm 1$ dB, $\pm 5^\circ$
Nominal insertion loss RF input to Port 1,2 RF input to R,A,B Port 1,2 to A,B	13 dB 19 dB 6 dB	19 dB 31 dB 6 dB
Max operating level	+20 dBm	+20 dBm
Damage level	+23 dBm	+23 dBm
Size	90H x 426W x 553mmD	90H x 426W x 553mmD
Weight	5.7 kg	5.7 kg

**HP 87512A 50  $\Omega$  Transmission/Reflection Test Kit****HP 87512B 75  $\Omega$  Transmission/Reflection Test Kit**

The HP 87512A/B transmission/reflection test kits provide the capability to measure transmission and reflection characteristics. The frequency range of the HP 87512A/B test kits is 5 Hz to 500 MHz.

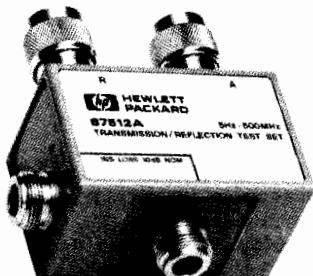
**HP 87512A/B Specifications**

	HP 87512A	HP 87512B
Impedance	50 $\Omega$	75 $\Omega$
Insertion loss	10 $\pm$ 1 dB typical	
Equivalent directivity	>40 dB typical	
Equivalent source match	>30 dB typical	>25 dB typical

**HP 41802A 1 M $\Omega$  Input Adaptor**

The HP 41802A 1 M $\Omega$  input adaptor provides the capability to perform high-impedance measurement using HP network and spectrum analyzers. The frequency range of the HP 41802A input adaptor is 5 Hz to 100 MHz. Passive probe is required for measurement (probing).

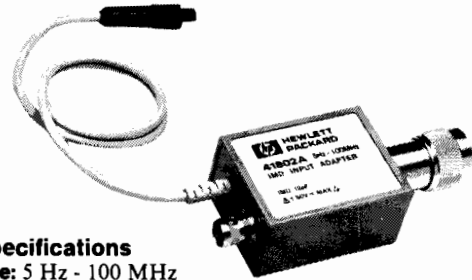
**HP 41802A Specifications****Frequency range:** 5 Hz - 100 MHz**Adaptor gain:** 0 dB  $\pm$  0.5 dB @ 1 MHz**Input R, C (typical):** 1 M $\Omega$ , 12pF**1dB Gain compression:** 0.32 V<sub>rms</sub> (+ 3dBm, 50 $\Omega$  terminated)**Damage level:** 2 V<sub>rms</sub>,  $\pm$  50 Vdc**Size:** 28H x 42W x 100mmD**Weight:** 400 g**Other Accessories**

HP 85031B Precision 7mm calibration kit

HP 85032B 50 $\Omega$  type-N calibration kit

HP 85033C Precision 3.5mm calibration kit

HP 85036B 75 $\Omega$  type-N calibration kitHP 11850C 50 $\Omega$  power splitterHP 11850D 75 $\Omega$  power splitterHP 11853A 50 $\Omega$  type N accessory kitHP 11854A 50 $\Omega$  BNC accessory kitHP 11855A 75 $\Omega$  type N accessory kitHP 11856A 75 $\Omega$  BNC accessory kit**Ordering Information**

	Price
HP 8751A Network analyzer	\$22,500
Opt 001 High-stability frequency reference	+\$850
Opt 002 HP Instrument BASIC and 1 Mbyte RAM	+\$1000
Opt 907 Front handle kit	+\$75
Opt 908 Rackmount kit	+\$40
Opt 909 Rack flange and handle kit	+\$105
Opt 910 Extra operating manual	+\$160
Opt 915 Add service manual	+\$140
HP 87511A 50 $\Omega$ S-parameter test set	\$5000
Opt 001 N-type port	N/C
HP 87511B 75 $\Omega$ S-parameter test set	\$5000
<b>Options (common for the HP 87511A/B)</b>	
Opt 907 Front handle kit	+\$50
Opt 908 Rackmount kit	+\$31
Opt 909 Rack flange and handle kit	+\$72
Opt 910 Extra operating manual	+\$50
HP 87512A 50 $\Omega$ transmission/reflection test kit	\$2000
HP 87512B 75 $\Omega$ transmission/reflection test kit	\$2500
HP 41802A 1M $\Omega$ input adaptor	\$900
HP 41800A Active probe	\$1700

# NETWORK ANALYZERS

## RF Network Analyzer, 300 kHz to 3 GHz

### HP 8752A

- 300 kHz to 1.3 or 3 GHz
- Integrated 1 Hz resolution synthesized source
- Integrated transmission/reflection test set
- Crisp color display
- Direct save/recall to an external disk drive
- Execute complex test procedures with the test sequence function
- 100 dB of dynamic range
- Group delay and deviation from linear phase
- Superb uncorrected performance

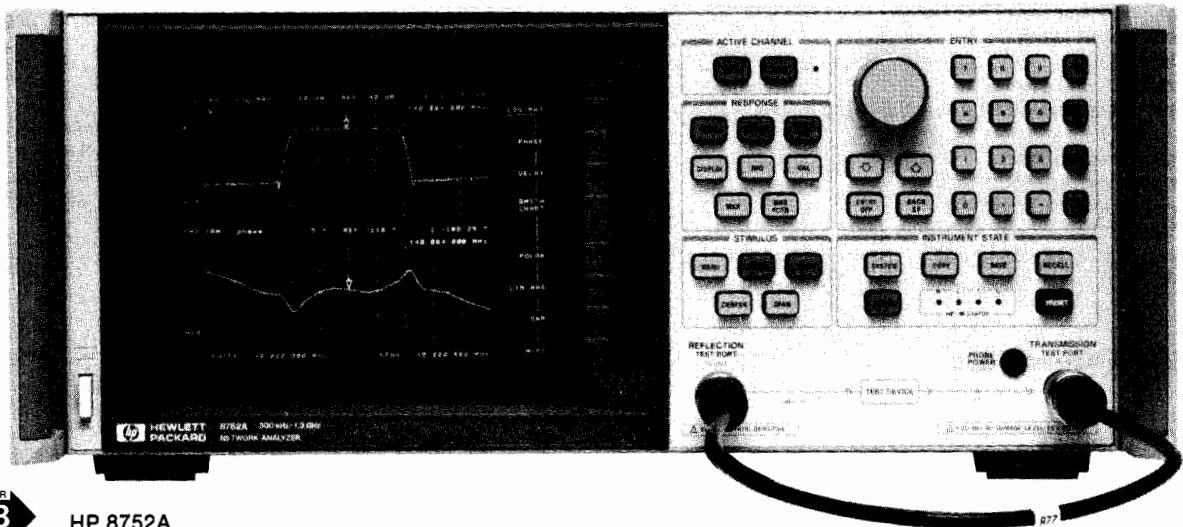

### HP 8752A RF Network Analyzer

The HP 8752A RF network analyzer provides simple and complete vector network measurements in a compact and fully integrated RF network analyzer. Characterize your RF components and networks accurately and economically with the HP 8752A RF network analyzer in the 300 kHz to 1.3 or 3 GHz frequency range. Integration of the swept synthesized source, test set, and receiver, results in a network analyzer that is easy to set up and use which is ideal for service, incoming inspection, production and final test measurements.

The integrated synthesized source provides measurement port power level of +5 to -20 dBm with linear, log, list, power, and CW sweep types. The sensitive, tuned receivers provide 100 dB of dynamic range.

With two independent display channels available, you can simultaneously measure the reflection and transmission characteristics of the device under test on the crisp color display. Data can be displayed in log magnitude, linear magnitude, SWR, phase, group delay, polar, real, or Smith chart formats. The easy-to-use softkey measurement functions allow you to quickly measure the desired characteristic of your device under test.

#### Designed for Manufacturing

The productivity features of the HP 8752A increase your throughput in production. The test sequence function provides rapid and consistent execution of complex, repetitive tests with a single keystroke. In sequencing mode, you make the measurement once from the front panel and the instrument automatically saves the keystrokes without an external computer.

The HP 8752A offers excellent uncorrected performance, allowing simple and accurate measurements of your device under test without the need for measurement calibration. Other productivity enhancements include a plot/print buffer, limit testing, arbitrary frequency testing, and marker tracking functions. Up to four on-screen markers are available per channel for hardcopy outputs or for tuning at specific frequencies.

#### Time Domain Analysis

The HP 8752A with option 010 has the capability of displaying the time domain response of a network, obtained by computing the inverse Fourier transform of the frequency domain response. Two time

domain modes are offered with the HP 8752A. The low pass mode provides traditional time domain reflector (TDR) measurement capability and gives the response of a mathematically simulated step or impulse response. The band pass mode, which has only the impulse stimulus, provides the time domain response of frequency-selective devices such as SAW filters and antennas.

#### Specifications

##### Source

##### Frequency characteristics

**Range:** 300 kHz to 1.3 GHz  
(Option 003: 300 kHz to 3 GHz)

**Resolution:** 1 Hz

**Accuracy:**  $\pm 10$  ppm

##### Output characteristics

**Power range:** -20 to +5 dBm

**Resolution:** 0.1 dB

**Flatness:** < 2 dB P-P

**Level accuracy (50 MHz, -5 dBm):**  $\pm 0.5$  dB

**Level linearity (relative to -5 dBm):**

-20 to -15 dBm:  $\pm 0.5$  dB

-15 to 0 dBm:  $\pm 0.2$  dB

0 to +5 dBm:  $\pm 0.5$  dB

**Impedance:** 50  $\Omega$

##### Receiver

**Frequency range:** 300 kHz to 1.3 GHz

(Option 003: 300 kHz to 3 GHz)

**Noise level:** reflection -85 dBm (typical)

Transmission -100 dBm

**Maximum input level:** 0 dBm

**Impedance:** 50  $\Omega$

**Crosstalk:** (300 kHz to 1.3 GHz) 100 dB

(1.3 to 3 GHz) 90 dB

**Dynamic accuracy:**  $\pm 0.05$  dB,  $\pm 0.3^\circ$  over a 50 dB input range

##### Delay characteristics:

**Range:**  $1/(2 * \text{minimum aperture})$

**Aperture (selectable):** frequency span / (points - 1) to 20% of the frequency span

**Accuracy:** (phase accuracy) / (360 \* aperture)

### Physical Characteristics

**Size:** 178H x 425W x 482mmD (7.0" x 16.75" x 20.0")  
**Weight:** net, 22kg (48lb); shipping, 25kg (55lb)

### Upgrade Kits

The following upgrade kits add optional measurement capability to existing HP 8752A network analyzers.

#### HP 11885A 3 GHz frequency upgrade

The HP 11885A upgrade kit extends the operating frequency range of the HP 8752A from 1.3 GHz to 3 GHz. Installation at an HP service center is included.

#### HP 85019C time domain upgrade kit

The HP 85019C upgrade kit adds time domain analysis capability (Option 010) to an existing HP 8752A network analyzer. This kit is user-installable.

### Accessories

#### HP 11878A adapter kit

The HP 11878A Adapter Kit provides the RF components generally required when a SMA or 3.5 mm device needs to be measured with the HP 8752A standard type N configuration. The kit includes four type N to 3.5 mm adapters to accommodate both male and female connectors.

#### Test port return cable (HP 8120-4781)

Hewlett Packard supplies a 610 mm (24 in) 50  $\Omega$  type N RF cable with every HP 8752A. Additional or replacement cables can be ordered separately.

#### HP 11852B 50 $\Omega$ /75 $\Omega$ minimum loss pad

The HP 11852B is a low SWR minimum loss pad required when measurements are made on 75  $\Omega$  devices with the HP 8752A network analyzer. Measurements on two port devices require two HP 11852Bs and one 50  $\Omega$  type N barrel.

**Frequency range:** dc to 2.0 GHz

**Insertion loss:** 5.7 dB

**Return loss:** 75  $\Omega$  typically >30 dB, 50  $\Omega$  typically >26 dB

**Connectors:** 50  $\Omega$  type N female and 75  $\Omega$  type N male

#### HP 85024A High Frequency Probe

The HP 85024A High Frequency Probe makes it easy to perform in-circuit measurements. An input capacitance of only 0.7 pF shunted by 1 Megohm of resistance permits high frequency probing without adversely loading the circuit under test. Excellent frequency response and unity gain guarantees high accuracy in swept measurements with this probe. High probe sensitivity and low distortion levels allows measurements to be made while taking advantage of the full dynamic range of HP RF analyzers. Spectrum analyzers which supply probe power from the front panel include the HP 8568B, 8590B, 8591A, 8560A, 8561B, 8562A/B, and 71100A. RF network analyzers like the HP 8753C, 8752A, 3577A, and 4195A are also directly compatible. You can use the HP 85024A with other instruments by using the HP 1122A Probe Power Supply or any dual  $\pm$  15V, 130 mA supply.

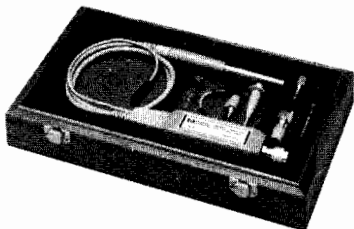

HP 85024A

### Specifications

**Input Capacitance (@ 500 MHz):** <0.7 pF (nominal)

**Input Resistance:** 1 M $\Omega$  (nominal)

**Bandwidth:** 300 kHz to 3 GHz

**Gain (@ 500 MHz):** 0 dB  $\pm$  1 dB

**Average Noise Level (10 Hz to 10 MHz):** <1 mV

**Frequency Response:**  $\pm$  1.25 dB (300 kHz to 1 GHz)  
 $\pm$  2, -3 dB (1 GHz to 3 GHz)

**Input Voltage for 1 dB Compression:** 0.3 V

**Maximum Safe RF Voltage:** 1.5V peak (with 10:1 divider 15V peak)

**Noise Figure:** <50 dB (<100 MHz)

<24 dB (100 MHz to 3 GHz)

**Distortion (@ 0.3 V):** <-30 dBc

#### Includes

Type N male adapter, 10:1 divider, spare probe tips, 2.5-inch ground lead, hook tip, spanner tip, and probe tip nut driver.

#### Calibration kits

Accuracy enhancement procedures characterize the systematic errors of the measurement system by measuring known devices (standards) on the system over the frequency range of interest. The calibration kits in the HP 8752A family contain precision standards with which to characterize the systematic errors of an HP 8752A measurement system.

#### HP 85032B Option 001 50 $\Omega$ type N calibration kit

Contains precision 50  $\Omega$  type N standards used to calibrate the HP 8752A for measurements of devices with 50  $\Omega$  type N connectors. This kit can also be used to perform system verification. Option 001 removes the precision phase-matched 7mm-to-type N adapters. Standards include fixed terminations, open circuits, and short circuits.

#### HP 85033C option 001 3.5 mm calibration kit

Contains precision 3.5 mm standards used to calibrate the HP 8752A network analyzer for measurements of devices with 3.5 mm or SMA connectors. Option 001 removes the precision phase-matched 7mm-to-3.5mm adapters. Standards include fixed terminations, open circuits, and short circuits.

### Ordering Information

	Price
HP 8752A Network Analyzer	\$22,200
Opt 003 3 GHz Frequency Extension	+\$4,000
Opt 010 Time Domain Capability	+\$4,800
Opt 802 add Dual Disk Drive and Cable	+\$1,545
Opt 908 Rack Mount Kit (without handles) (5062-3978)	+\$35 ☎
Opt 910 Extra Manual	+\$150 ☎
Opt 913 Rack Mount Kit (5062-4072)	+\$40 ☎
HP 11885A 3 GHz Frequency Upgrade	\$3,500
HP 85019C Time Domain Upgrade	\$5,000
HP 85032B Opt 001 50 $\Omega$ Type N Calibration Kit	\$1,100
HP 85033C Opt 001 3.5 mm Calibration Kit	\$2,000
HP 11878A 3.5 mm Adapter Kit	\$550
HP 11853A 50 $\Omega$ Type N Accessory Kit	\$400
HP 11854A 50 $\Omega$ BNC Accessory Kit	\$400
HP 8120-4781 Type N Replacement Test Port Cable	\$350
HP 85024A High Frequency Probe	\$1,900 ☎

☎ For same-day shipment, call HP DIRECT at 800-538-8787

# NETWORK ANALYZERS

## RF Network Analyzer, 300 kHz to 6 GHz

### HP 8753C

- 300 kHz to 6 GHz
- Integrated 1 Hz resolution synthesized source
- Direct save/recall to an external disk drive
- Time domain analysis
- Execute complex test procedures with the test sequence function
- Crisp color display
- 100 dB of dynamic range
- Group delay and deviation from linear phase
- 0.001 dB, 0.01 deg, 0.01 nanosec marker resolution
- Built-in accuracy enhancement
- Swept harmonic measurements

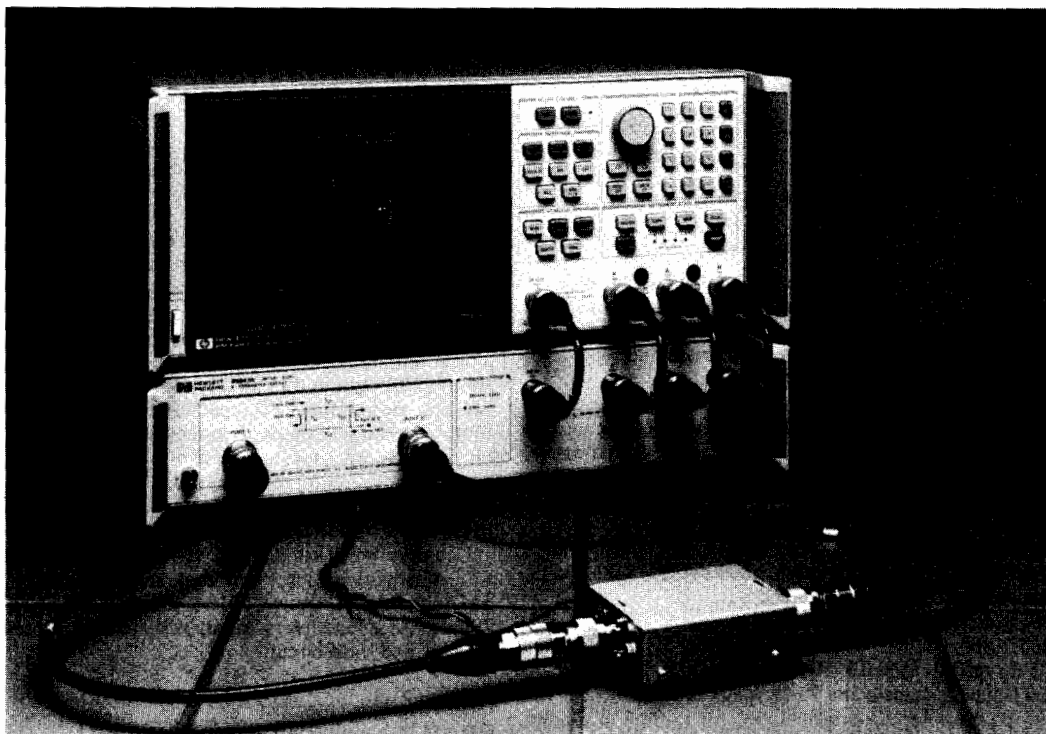

HP 8753C with HP 85047A



### HP 8753C Network Analyzer

The HP 8753C network analyzer provides excellent RF network measurements for lab and production test areas. When combined with a test set, it provides a complete solution for characterizing linear behavior of either active or passive networks, devices, or components from 300 kHz to 6 GHz. With two independent display channels available, you can simultaneously measure and view the reflection and transmission characteristics of the device under test in overlay or split-screen format on the crisp color display. The easy-to-use softkey selection of measurement functions allows you to measure the magnitude, phase, or group delay characteristics of your device under test.

The test sequence function allows rapid and consistent execution of complex repetitive tests with a single keystroke. In sequencing mode, you make the measurement once from the front panel, and the instrument stores the keystrokes so no additional programming expertise is required. You can even set other HP-IB instruments with a test sequence. Other productivity enhancements include a plot/print buffer, limit testing, arbitrary frequency testing, and marker tracking functions. Segmented calibration and interpolative error correction allow you to apply vector accuracy enhancement over a subset of the frequency range that you initially calibrated the HP 8753C.

The HP 8753Cs integrated synthesized source provides > 100 mW of output power, 1 Hz frequency resolution, and linear, log, list, power, and CW sweep types. Three tuned, 300 kHz to 3 GHz (Option 006 - extends to 6 GHz) receivers allow versatile independent power measurements or simultaneous ratio measurements over a 100 dB dynamic range. By using the HP 85047A Test Set with the HP 8753C, the reflection and transmission characteristics of the device under test can be investigated from 300 kHz to 3 GHz or from 3 MHz to 6 GHz with the test set's frequency doubler enabled.

### Non-linear Device Testing

Non-linear device characterization is possible with the HP 8753C. Swept 2nd and 3rd harmonic levels of an amplifier can be displayed directly or relative to the fundamental carrier (dBc) when employing the optional harmonic measurement capability (Option 002). Amplifier harmonics up to 40 dBc can be measured quickly and conveniently on a swept-frequency basis for fundamental signals as low as 16 MHz, using the same test configuration used to measure gain. Power meter calibration provides a leveled absolute power to devices that are sensitive to absolute input or output levels. The HP 8753C automatically controls an HP 436A, 437B, or 438A Power Meter to set the power anywhere in the test configuration with power meter accuracy.

The HP 8753C has the capability to perform mixer tracking and conversion loss measurements. These are possible because the HP 8753Cs tuned receiver can be offset from its synthesized source by the LO frequency of the mixer.

### Time Domain Analysis

Time domain responses can be displayed by the HP 8753C with Option 010. The instrument computes the Inverse Fourier Transform of the frequency domain data to display the reflection or transmission coefficient versus time. The HP 8753C offers two time domain modes. The Low Pass mode provides the traditional Time Domain Reflectometer (TDR) measurement capability and gives the response of the network to a mathematically simulated step or impulse response. This mode gives information of the type of impedance (R, L, C) at the discontinuity. The Band Pass time domain mode, which has only the impulse stimulus, has no frequency restrictions and provides the time domain response of frequency selective devices such as SAW filters or antennas. Gating may be used to selectively isolate a single response to view the frequency domain response of individual portions of a component without disturbing the circuit itself.



## HP 8753C Specifications Summary

### Source

#### Frequency Characteristics

**Frequency Range:** 300 kHz to 3 GHz

**Frequency Resolution:** 1 Hz

**Frequency Accuracy (25 C):**  $\pm 10$  ppm

#### Output Characteristics

**Power Range:**  $-5$  to  $+20$  dBm

**Power Accuracy** (50 MHz,  $+10$  dBm):  $\pm 0.5$  dB

**Power Linearity** (relative to  $+10$  dBm, 25 .5 C):

.5 to 0 dBm:  $\pm 0.5$  dB

0 to  $+15$  dBm:  $\pm 0.2$  dB

$+15$  to  $+20$  dBm:  $\pm 0.5$  dB

**Impedance:** 50 ohms

**Harmonics:**  $\leq -25$  dBc (20 dBm output level)

typically  $\leq -50$  dBc (0 dBm output level)

#### Nonharmonics:

**Mixer Related:**  $\leq -32$  dBc (20 dBm output level)

typically  $\leq -55$  dBc (0 dBm output level)

#### Other Spurious:

$f < 135$  MHz:  $-60$  dBc

$f \geq 135$  MHz:  $-60$  dBc +  $20 \cdot \log(f/135 \text{ MHz})$

**Phase Noise** (10 kHz offset in 1 Hz BW):

$f < 135$  MHz:  $-90$  dBc

$f \geq 135$  MHz:  $-90$  dBc +  $20 \cdot \log(f/135 \text{ MHz})$

### Receiver

**Frequency Range:** 300 kHz to 6 GHz

**Inputs:** A, B 100 dB dynamic range  $< 3$  GHz

95 dB dynamic range 3 to 6 GHz

**Sensitivity** (noise level):

3 kHz BW:  $-90$  dBm  $< 3$  GHz,  $-85$  dBm 3 to 6 GHz

10 Hz BW:  $-100$  dBm  $< 3$  GHz,  $-95$  dBm 3 to 6 GHz

**Maximum Input Level:** 0 dBm

**Impedance:** 50 ohms

#### Input Crosstalk:

300 kHz to 1 GHz:  $-100$  dB

1 GHz to 3 GHz:  $-90$  dB

3 GHz to 4.5 GHz:  $-85$  dB

4.5 GHz to 6 GHz:  $-75$  dB

**Dynamic Accuracy:**  $\pm 0.05$  dB,  $\pm 0.3^\circ$  over a 50 dB input range

#### Delay Characteristics:

**Range:**  $1/2 \cdot (1/\text{minimum aperture})$

**Aperture:** selectable (frequency span)/(# points  $-1$ ) to 20% of the frequency span

**Resolution:**  $27.8/(\text{aperture in Hz})$

typically 0.01 nanoseconds

**Accuracy:** (phase accuracy)/( $360 \cdot \text{aperture in Hz}$ )

### Physical

#### Size:

178 H x 425 W x 498 mm D

(7.0" x 16.75" x 20.0")

**Weight:** net 22 kg (48 lb); shipping 25 kg (55 lb)

### Upgrade Kits

The following upgrade kits retrofit the latest operating systems or add optional measurement capability to existing HP 8753A/B/C network analyzers.

#### HP 11882A upgrade kit for the HP 8753A

This kit upgrades an HP 8753A to an HP 8753B with revision 3.0 firmware. New measurement capabilities include mixer measurements, support of 6 GHz and solid-state test sets, interpolative error correction, and the test sequencing function (for built-in automatic measurements). Options for 6 GHz receiver and harmonic measurements can also be added to an HP 8753A after the HP 11882A kit has been installed. This kit includes installation at an HP service center.

#### HP 11883A harmonic measurements upgrade

This upgrade kit adds harmonic measurement capability (Option 002) to an HP 8753B/C network analyzer. This kit includes installation at an HP service center.

#### HP 11884A 6 GHz receiver upgrade

This kit extends the operating frequency range of the HP 8753B/C receiver from 3 GHz to 6 GHz. To make transmission/reflection measurements above 6 GHz, the HP 85047A S-parameter test set is required. This kit includes installation at an HP service center.

#### HP 85019A time domain upgrade kit

This upgrade kit adds time domain analysis capability (Option 010) to an existing HP 8753A network analyzer. This kit is user-installable.

#### HP 85019B time domain upgrade kit

This upgrade kit adds time domain analysis capability (Option 010) to an existing HP 8753B/C network analyzer. This kit is user-installable.

#### HP 86388A upgrade kit for the HP 8753B

This kit adds the latest firmware revision to an existing HP 8753B (revision 2.01). Significant enhancements include diskfile compatibility with HP 8753C network analyzers and support of solid-state switching test sets. This kit is user-installable.

#### HP 8753C Accessories

##### HP 85044A 50 Ohm Transmission/Reflection Test Set

##### HP 85044B 75 Ohm Transmission/Reflection Test Set

The HP 85044 A/B Transmission/Reflection test sets provide the capability to simultaneously measure the reflection and transmission characteristics of 50 and 75 ohm devices. Two-port devices must be physically turned around to measure their reverse direction characteristics. Test port connectors are precision 7 mm and 75 ohm type N (f), respectively.

Specifications	HP 85044A	HP 85044B
<b>Impedance:</b>	50 $\Omega$	75 $\Omega$
<b>Frequency Range:</b>	300 kHz to 3 GHz	300 kHz to 2 GHz
<b>Directivity<sup>2</sup>:</b>	35 dB to 1.3 GHz 30 dB to 3.0 GHz	35 dB to 1.3 GHz 30 dB to 2.0 GHz

Typical Tracking:	HP 85044A	HP 85044B
<b>Transmission Magnitude, Phase<sup>1,2,3</sup>:</b>		
.3 MHz to 2.0 MHz	$\pm 1.5$ dB, $\pm 10^\circ$	$\pm 1.5$ dB, $\pm 10^\circ$
2.0 MHz to $F_{\max}$	$\pm 1.5$ dB, $\pm 10^\circ$	$\pm 1.5$ dB, $\pm 10^\circ$
<b>Reflection Magnitude, Phase<sup>1,2,3</sup>:</b>		
.3 MHz to 2.0 MHz	$\pm 1.5$ dB, $\pm 25^\circ$	$\pm 1.5$ dB, $\pm 25^\circ$
2.0 MHz to $F_{\max}$	$\pm 1.5$ dB, $\pm 10^\circ$	$\pm 1.5$ dB, $\pm 10^\circ$
<b>Effective Source Match<sup>2,3</sup>:</b>		
<b>(Test Ports):</b>		
.3 MHz to 2.0 MHz	14 dB	14 dB
2.0 MHz to 1.3 GHz	20 dB	17 dB
1.3 GHz to $F_{\max}$	16 dB	16 dB

#### RF Connectors:

**Test Port:** precision 7 mm 75  $\Omega$  type N (f)

**All others:** 50  $\Omega$  type N (f) 50  $\Omega$  type N (f)

**Includes:** HP 85044A—one precision 7 mm to 50  $\Omega$  type N (f) adapter; HP 85044B—one HP 11852B minimum loss pad.

#### Recommended

**Accessories:** HP 11851B RF cable kit

**Size:** 615H x 101 W x 204 mm D (2.44" x 7.5" x 8.0")

**Weight:** net, 1.7 kg (3.8 lb)

<sup>1</sup>Degrees, specified as deviation from linear phase.

<sup>2</sup> $F_{\max}$  is the upper frequency limit of the associated test set.

<sup>3</sup>Can be improved through Accuracy Enhancement.

# NETWORK ANALYZERS

## S-parameter test sets

### HP 8753C Series

#### S-Parameter Test Sets

The S-parameter test sets provide the capability to measure reflection and transmission characteristics (including s-parameters) of two port devices in either direction with a single connection. The test sets are controlled from the HP 8753C and include a programmable step attenuator.

#### HP 85046A/B S-Parameter Test Set

Test port connectors are precision 7 mm and 75  $\Omega$  type N (f), respectively. Both connectors can be adapted to other interfaces with the appropriate precision adapters.

#### Solid-state switching

Solid-state switching allows for simultaneous measurement of forward and reverse parameters and continuous update of all 4 S-parameters as required for 2-port error correction (used to achieve best possible measurement accuracy). Option 009 replaces the standard solid-state RF test port switch with a mechanical RF switch. HP 8753 Systems specifications for standard and Option 009 test sets are identical. Nominal insertion loss of the solid-state switch is less than 2 dB (@ 3 GHz) relative to a mechanical switch. (Option 009).

The solid-state switch can be retrofitted into any existing HP 85046A/B test set using the HP 86389A solid-state switch upgrade kit. Solid-state switching test sets are supported on HP 8753C and HP 8753B network analyzers revision 3.0 or higher. For HP 8753A/B network analyzers with revision 2.01 or lower, upgrade kits are available, which add support for solid-state test switching test sets.

#### Specifications Summary

	HP 85046A	HP 85046B
<b>Impedance</b>	50 $\Omega$	75 $\Omega$
<b>Frequency Range</b>	300 kHz to 3 GHz	300 kHz to 2 GHz
<b>Directivity</b>	35 dB to 1.3 GHz 30 dB to 3.0 GHz	35 dB to 1.3 GHz 30 dB to 2.0 GHz

#### Typical tracking

##### Transmission magnitude, phase<sup>1,2,3</sup>

.3 MHz to 2.0 MHz	$\pm 1.5$ dB, $\pm 20^\circ$	$\pm 1.5$ dB, $\pm 20^\circ$
2.0 MHz to $F_{\max}$	$\pm 1.5$ dB, $\pm 10^\circ$	$\pm 1.5$ dB, $\pm 10^\circ$

##### Reflection magnitude, phase<sup>1,2,3</sup>

.3 MHz to 2.0 MHz	$\pm 1.5$ dB, $\pm 25^\circ$	$\pm 1.5$ dB, $\pm 25^\circ$
2.0 MHz to $F_{\max}$	$\pm 1.5$ dB, $\pm 10^\circ$	$\pm 1.5$ dB, $\pm 10^\circ$

##### Effective source match<sup>3</sup>

(Test Ports)	HP 85046A	HP 85046B
.3 MHz to 2.0 MHz	14 dB	14 dB
2.0 MHz to 1.3 GHz	20 dB	17 dB
1.3 GHz to $F_{\max}$	16 dB	16 dB

#### RF connectors

<b>Port 1, 2</b>	precision 7 mm	75 $\Omega$ type N (f)
<b>All others</b>	50 $\Omega$ type N (f)	50 $\Omega$ type N (f)

**Includes:** Four 190 mm (7.5") cables with type N (m) connectors for connection to the HP 8753C. One HP 8753C test set interconnect cable.

#### Recommended Accessories

HP 11857D cables    HP 11857B cables

**Size:** 90 H x 426 W x 553 mmD (3.5" x 16.75" x 21.5")

**Weight:** 9.1 kg (20 lb)

#### HP 85047A S-parameter Test Set

This test set includes a frequency doubler that can be switched in to measure 3 MHz to 6 GHz in a single sweep or switched out to measure 300 kHz to 3 GHz in a single sweep. The HP 8753C controls the frequency doubler. HP 8753C Option 006 (6 GHz receiver) is required to activate the HP 85047A. There are two rear panel BNC outputs. One provides a TTL signal which indicates the result of a limit test. The second TTL output is controlled from the HP 8753C test sequence function.

#### Solid-state switching

Solid-state switching allows for simultaneous measurement of forward and reverse parameters and continuous update of all 4 S-parameters as required for 2-port error correction (used to achieve best possible measurement accuracy). Option 009 replaces the solid-state RF test port switch, which is standard, with a mechanical RF switch. HP 8753 Systems specifications for standard and Option 001 test sets are identical. Nominal insertion loss of the solid-state switch is less than 3 dB (@ 6 GHz) relative to a mechanical switch. (Option 009).

The solid-state switch can be retrofitted into any existing HP 85047A test set using the HP 86389B solid-state switch upgrade kit. Solid-state switching test sets are supported on HP 8753C and HP 8753B network analyzers revision 3.0 or higher. For HP 8753B network analyzers with Revision 2.01 or lower, upgrade kits are available, which add support for solid-state test switching test sets.

#### Specifications

**Impedance:** 50  $\Omega$

**Frequency ranges:** 300 kHz to 3 GHz  
3 MHz to 6 GHz

**Directivity:** 300 kHz to 1.3 GHz: 35 dB  
1.3 GHz to 3 GHz: 30 dB  
3 GHz to 6 GHz: 25 dB

#### Typical tracking

##### Transmission magnitude, phase

300 kHz to 3 GHz:  $\pm 1.5$  dB,  $\pm 10^\circ$   
3 GHz to 6 GHz: +0.5, -2.5 dB,  $\pm 20^\circ$

##### Reflection magnitude, phase:

300 kHz to 3 GHz:  $\pm 1.5$  dB,  $\pm 10^\circ$   
3 GHz to 6 GHz:  $\pm 1.5$  dB,  $\pm 20^\circ$

##### Effective source match

300 kHz to 1.3 GHz: 20 dB  
1.3 GHz to 3 GHz: 16 dB  
3 GHz to 6 GHz: 14 dB

#### RF connectors:

**Port 1, 2:** precision 7 mm

**All others:** 50  $\Omega$  type N (f)

**Includes:** Four 190 mm (7.5") cables with type N (m) connectors for connection to the HP 8753C. One HP 8753C test set interconnect cable.

**Recommended accessories:** HP 11857D cables

**Size:** 90 H x 426 W x 533 mmD (3.5" x 16.75" x 21.5")

**Weight:** 10 kg (22 lb)

#### HP 86389A/B Solid-state Switch Upgrade Kits

This kit retrofits any existing HP 85046A/B and HP 85047A S-parameter test set by replacing the mechanical RF test port switch with a solid-state RF switch. This solid-state switch allows for simultaneous measurement of forward and reverse parameters and continuous measurement of all 4 S-parameters (required for 2-port error correction).

The HP 86389A retrofits HP 85046A/B test sets, and the HP 86389B retrofits HP 85047A test sets. HP 8753B/C network analyzers with revision 3.0 or higher support solid-state test sets. HP 8753A/B network analyzers with Revision 2.01 or lower must be upgraded (HP 11882A for the HP 8753A, HP 86388A for the HP 8753B). This kit includes installation at an HP service center.

<sup>1</sup>Degrees, specified as deviation from linear phase.

<sup>2</sup> $F_{\max}$  is the upper frequency limit of the associated test set.

<sup>3</sup>Can be improved through Accuracy Enhancement.



## HP 11850C/D Three-Way Power Splitters

Specifications	HP 11850C	HP 11850D
<b>Impedance:</b>	50 $\Omega$	75 $\Omega$
<b>Frequency Range:</b>	dc to 3 GHz	dc to 2 GHz
<b>Tracking:</b>	$\pm 25$ dB, $+3^\circ$	$\pm 2$ dB, $\pm 2.5^\circ$
<b>Equivalent Source Match</b> (ratio or leveling)	30 dB @ 1.3 GHz 20 dB @ 3 GHz	30 dB @ 1.3 GHz 20 dB @ 3 GHz
<b>Nominal Insertion Loss:</b>	9.5 dB +1 dB/GHz	7.8 dB
<b>Input Port Match:<sup>1</sup></b>		
dc to 1.3 GHz	20 dB	20 dB
1.3 GHz to $F_{max}$	10 dB	10 dB
<b>RF Connectors:</b>		
<b>RF Input:</b>	50 $\Omega$ type N (f)	50 $\Omega$ type N (f)
<b>All Others:</b>	50 $\Omega$ type N (f)	75 $\Omega$ type N (f)
<b>Includes:</b> 3 ea HP 11852B	50 to 75 $\Omega$ min. loss pads	
<b>Recommended Accessories:</b>	HP 11851B RF cable kit	

## HP 11851B RF Cable Kit

This kit includes three 610 mm (24 in.) 50  $\Omega$  cables phase matched to  $4^\circ$  at 1.3 GHz and one cable 860 mm (34 in.). Connectors are type N male. Recommended for use with HP 85044A/B Transmission/Reflection Test Set and HP 11850C/D Power Splitter.

**Weight:** net, 0.91 kg (2 lb); shipping, 1.36 kg (3 lb).

## HP 11852B 50 $\Omega$ /75 $\Omega$ Minimum Loss Pad

The HP 11852B is a low SWR minimum loss pad required for transmission measurements on 75  $\Omega$  devices with HP 8753C receiver (50  $\Omega$ ).

**Frequency range:** dc to 2.0 GHz.

**Insertion loss:** 5.7 dB.

**Return loss:** 75  $\Omega$  typically  $\geq 30$  dB. 50  $\Omega$  typically  $\geq 26$  dB.

**Maximum input power:** 250 mW (+24 dBm).

**Connectors:** 50  $\Omega$  type N female and 75  $\Omega$  type N male.

## Type N Accessory Kits

Each kit contains a type N female short, a type N male short, two type N male barrels, two type N female barrels and storage case.

### HP 11853A 50 $\Omega$ Type N Accessory Kit

The HP 11853A accessory kit furnishes the RF components required for measurement of devices with 50  $\Omega$  Type N Connectors using the HP 11850C, 85044A, 85046A or 85047A.

### HP 11855A 75 $\Omega$ Type N Accessory Kit

The HP 11855A accessory kit provides the RF connecting hardware generally required for measurement of devices with 75  $\Omega$  type N connectors using the HP 85044B, 85046B or 11850D. This kit also contains a 75  $\Omega$  type N male termination.

## BNC Accessory Kits

The BNC accessory kit contains two type N male to BNC Female adapters, two type N male to BNC male adapters, two type N female to BNC female adapters, two type N female to BNC male adapters, a BNC male short and storage case.

### HP 11854A 50 $\Omega$ BNC Accessory Kit

The HP 11854A accessory kit furnishes the RF components required for measurement of devices with 50  $\Omega$  BNC Connectors using the HP 11850C, 85044A, 85046A or 85047A.

### HP 11858A 75 $\Omega$ BNC Accessory Kit

The HP 11858A provides the RF connecting hardware generally required for measurement of devices with 75  $\Omega$  BNC connectors using the HP 85044B, 11850D, or 85046B. This kit also contains a 75  $\Omega$  BNC male termination, and storage case.

## HP 11857D 50 $\Omega$ APC-7 Test Port Extension Cables

This kit includes two precision 61 cm (24 in) cables, phase matched to  $2^\circ$  at 1.3 GHz for use with HP 85046 A S-parameter test set. Connectors are 50  $\Omega$  APC-7.

## HP 11857B 75 $\Omega$ Type N Test Port Extension Cables

This kit includes two precision 61 cm (24 in.) cables, phase matched to  $2^\circ$  at 1.3 GHz for use with HP 85046B S-parameter test set. One cable has 75  $\Omega$  type N male connectors on both ends; the other has one type N male and one type N female connector.

## HP 11600B/11602B Transistor Fixtures

**Function:** mounts on front of HP 85046 and 85047 S-Parameter Test Sets, holds devices for S-parameter measurements in a 50  $\Omega$ , coax circuit.

### Transistor Base Patterns

**Model 11600B:** accepts TO-18/TO-72 packages.

**Model 11602B:** accepts TO-5/TO-12 packages.

**Calibration references:** short circuit termination and a 50  $\Omega$  through-section.

**Frequency range:** dc to 2 GHz.

**Impedance:** 50  $\Omega$  nominal.

**Reflection coefficient:**  $< 0.05$ , 100 MHz to 1.0 GHz:  $< 0.09$ , 1.0 to 2 GHz.

**Connectors:** hybrid APC-7; Option 001, type N female.

## HP 11858A Transistor Fixture Adapter

The HP 11858A adapts the HP 11600B and 11602B transistor fixtures (vertical test port configuration) to the HP 85046A or 85047A S-parameter test set. Connectors are APC-7.

## HP 85043B Systems Cabinet

The HP 85043B systems cabinet has been ergonomically designed specifically for the HP 8753C and the HP 85046A/B or 85047A S-parameter test sets. The 122 cm (48-inch) system cabinet includes a bookcase, a drawer, and a convenient work surface.

## Calibration Kits

Accuracy enhancement procedures characterize the systematic errors of the measurement system by measuring known devices (standards) on the system over the frequency range of interest. The calibration kits in the HP 8753C family contain precision standards with which to characterize the systematic errors of a HP 8753C measurement system.

### HP 85031B 7 mm Calibration Kit

The HP 85031B 7 mm calibration kit contains a set of precision 7 mm fixed terminations, an open circuit, and a short circuit used to calibrate the HP 8753C and its 50 ohm test sets for measurement of devices with precision 7 mm connectors.

<sup>1</sup> $F_{max}$  is the upper frequency limit of the associated power splitter.

# NETWORK ANALYZERS

## Accessories (cont'd)

### HP 8753C Series

#### HP 85032B 50 $\Omega$ Type N Calibration Kit

The HP 85032B Calibration Kit contains precision 50  $\Omega$  type N standards used to calibrate the HP 8753C and its 50  $\Omega$  test sets for measurement of devices with 50  $\Omega$  type N connectors. Precision phase-matched 7 mm to 50  $\Omega$  type N adapters are included for accurate measurements of non-insertable devices. Standards include fixed terminations, open circuits, and short circuits.

Options 001 and 002 are intended solely for use with the HP8752A network analyzer. Option 001 removes the precision phase-matched 7 mm to type N adapters. Option 002 provides a Certificate of Traceability and measurement data for each calibration standard.

#### HP 85033C 3.5 mm Calibration Kit

The HP 85033C Calibration Kit contains precision 3.5 mm standards used to calibrate the HP 8753C and its 50  $\Omega$  test sets for measurement of devices with 3.5 mm and SMA connectors. Standards include fixed terminations, open circuits, and short circuits. Precision 7 mm to 3.5 mm adapters are included for accurate measurements of non-insertable devices.

Option 001 is intended solely for use with the HP 8752A network analyzer. Option 001 removes the precision phase-matched 7 mm to type N adapters.

#### HP 85036B 75 $\Omega$ type N Calibration Kit

The HP 85036B Calibration Kit contains precision 75  $\Omega$  type N standards used to calibrate the HP 8753C and its 75  $\Omega$  test sets for measurement of devices with 75  $\Omega$  type N connectors. Standards include fixed terminations, open circuits, and short circuits. Precision phase-matched adapters are included for accurate measurements of non-insertable devices.

#### Verification Kits

Measuring known devices, other than the calibration standards, is a convenient way of verifying that the HP 8753C measurement system is operating properly.

#### HP 85029B 7 mm Verification Kit

The HP 85029B Verification Kit contains a set of precision 7 mm devices, with data traceable to NBS, used to verify the calibrated performance of an HP 8753C measurement system. The devices have precision 7 mm connectors and include a 20 dB pad, a 50 dB pad and a mismatch attenuator. Verification process requires only an HP 85031B calibration kit, an HP 85029B verification kits and an external 3.5" disk drive connected to the HP 8753C.

Option 001 is intended solely for use with the HP 8702B Lightwave Component Analyzer. Option 001 adds verification data which is compatible with the HP 8702B.

#### Software

Software operates with a BASIC operating system using an HP Series 300 computer (2 megabytes of memory required).

#### HP 85160A Measurement Automation Software

Measurement automation software simplifies device measurements by providing guided measurements, limit testing, sequencing to test all four S-parameters, data formatting flexibility (data files can be formatted to be compatible with Touchstone® linear circuit simulation programs) and complete save/recall capability to a floppy disk. After it is configured, you simply recall a test file and calibration data, connect the device-under-test, and output the results.

#### HP 85165A Resonator Measurement Software

Resonator measurement software performs complete characterization of crystals, SAWs, and other resonant devices using the HP 8753C. The software guides the user through the measurement process and calculates key parameters of the device under test according to the EIA-512 resonator measurement standard.

#### Service and Support Products

Service and support products are available for HP 8753C measurement systems. On-site support products require a specific 50 ohm two-port measurement configuration.<sup>1</sup> Contact your local HP sales office for availability and price.

#### Ordering Information

	Price
HP 8753C Network Analyzer	\$26,000
Opt 002 Harmonic Measurement Capability	+\$3,000
Opt 006 6 GHz Receiver Option	+\$3,000
Opt 010 Time Domain Capability	+\$4,800
Opt 802 add Dual Disk Drive and HP 10883A cable	+\$1,545
Opt 908 Rack Mount Kit (without handles) (5062-3978)	+\$35
Opt 910 Extra Operating and Service Manual	+\$150
Opt 913 Rack Mount Kit (5062-4072)	+\$40
HP 85047A 6 GHz S-Parameter Test Set	\$10,800
Opt 009 Mechanical test port switch	\$1,000
Opt 913 Rack Mount Kit (5062-4069)	+\$40
HP 85046A 50 $\Omega$ S-Parameter Test Set	9,000
Opt 009 Mechanical test port switch	\$1,000
Opt 913 Rack Mount Kit (5062-4069)	+\$40
HP 85046B 75 $\Omega$ S-Parameter Test Set	\$9,000
Opt 009 Mechanical test port switch	\$1,000
Opt 913 Rack Mount Kit (5062-4069)	+\$40
HP 85044A 50 $\Omega$ Transmission/Reflection Test Set	\$3,200
HP 85044B 75 $\Omega$ Transmission/Reflection Test Set	\$3,700
HP 85029B Precision 7 mm Verification Kit	\$1,600
Opt 001 Data for HP 8702B	\$0
HP 85031B Precision 7 mm Calibration Kit	\$1,200
HP 85032B 50 $\Omega$ type N Calibration Kit	\$1,600
Opt 001 Deletes 7 mm to type N adapters	-\$500
Opt 002 Certificate of Traceability	+\$200
HP 85033C Precision 3.5 mm Calibration Kit	+2,500
Opt 001 Deletes 7 mm to 3.5 mm adapters	-\$500
HP 85036B 75 $\Omega$ type Calibration Kit	\$2,000
HP 85043B Systems Rack	\$3,000
HP 85033A SMA Kit	\$1,100
HP 85160A Measurement Automation Software	\$1,550
HP 85165A Resonator Measurement Software	\$5,000
HP 11882A Upgrade kit for HP 8753A	\$3,000
HP 11883A Harmonic measurements (Opt 002) upgrade	\$3,500
HP 11884A 6 GHz receiver (Opt 006) upgrade	\$3,500
HP 85019A Time domain (Opt 010) upgrade (HP 8753A)	\$5,000
HP 85019B Time domain (Opt 010) upgrade (HP8753B/C)	\$5,000
HP 86388A Upgrade kit for HP 8753B (Rev 3.00)	\$300
HP 86389A Solid-state switch upgrade kit (for HP 85046A/B test sets)	\$1,500
HP 86389B Solid-state switch upgrade kit (for HP85047A test sets)	\$1,500
HP 11850C 50 $\Omega$ Power Splitter	\$900
HP 11850D 75 $\Omega$ Power Splitter	\$1,500
HP 11851B type N RF Cable Kit	\$800
HP 11852B 50 to 75 $\Omega$ Minimum Loss Pad	\$350
HP 11853A 50 $\Omega$ type N Accessory Kit	\$400
HP 11854A 50 $\Omega$ BNC Accessory Kit	\$400
HP 11855A 75 $\Omega$ type N Accessory Kit	\$500
HP 11856A 75 $\Omega$ BNC Accessory Kit	\$500
HP 11857B 75 $\Omega$ type N Test Port Extension Cables	\$1,455
HP 11857D 50 $\Omega$ APC-7 Test Port Extension Cables	\$1,050
HP 11600B/11602B Transistor Fixtures	\$1,800
HP 11858A Transistor Fixture Adapter	\$980
☎ For same-day shipment, call HP DIRECT at 800-538-8787	

<sup>1</sup>The specific 50  $\Omega$  two-port measurement system includes the HP 8753C, the HP 85046A S-parameter test set, the HP 85031B 7 mm calibration kit, and the HP 11857D 7 mm test port extension cable set. This is a minimum configuration required for on-site verification.

# NETWORK ANALYZERS

## Vector Voltmeter and Input Modules

HP 8508A, 70138A, 85081B, 85082A

245

- RF Voltage and Phase Measurements
- 100 kHz to 1 GHz High Impedance Probe Inputs
- 300 kHz to 2 GHz 50 ohm Inputs

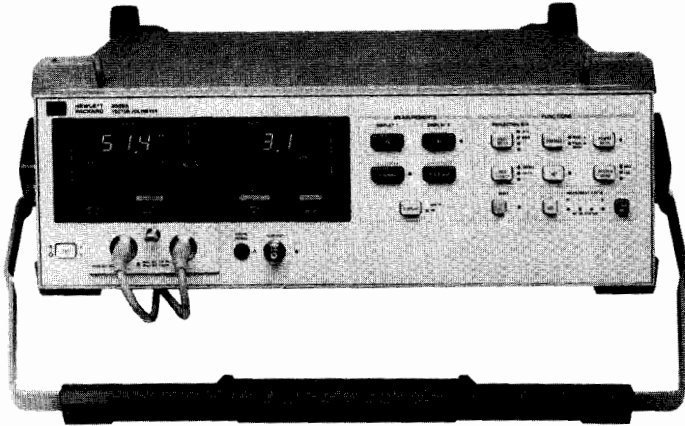

HP 70138A

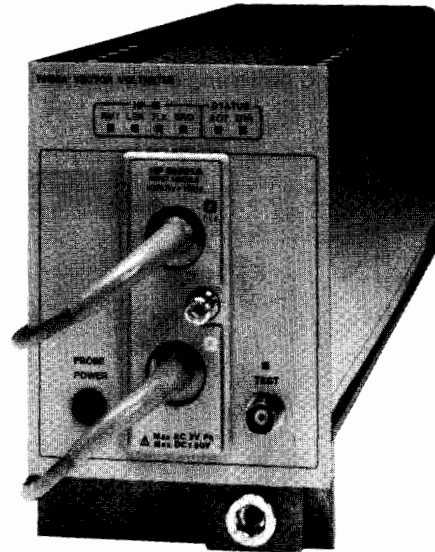

HP 8508A Option 001

### HP 8508A and HP 70138A Vector Voltmeters

The HP 8508A and HP 70138A vector voltmeters are fully automatic tuned receivers that makes RF voltage and phase measurements easy. Their narrowband measuring technique gives a dynamic range of over 90dB and a sensitivity of 10uV to trace even the smallest signal. These vector voltmeters also measure the phase difference between their two input channels with at least 0.1 degree resolution over a full +180 to -180 degree range, so it can be used for another complete set of measurements - like electrical length, phase distortion or impedance. The standard unit is supplied with the HP 85081B Input Module which has two high impedance probe inputs that operate from 100kHz to 1GHz. Its ability to store a reference and use it in later measurements means individual circuit sections can be characterized and adjusted independently. Any CW source can be used as a stimulus - even a source that is part of the device being tested, so measurements can be made under normal operating conditions. To adapt the probe inputs for measurements in a 50 ohm environment, the HP 11570A Accessory Kit provides two HP 11536A Probe Tees, an HP 11549A Power Splitter and two HP 908A 50 ohm Terminations. Option 050 is supplied with the HP 85082A Input Module. Its 50 ohm inputs operate from 300kHz to 2GHz, and provide the accuracy and dynamic range to make measurements on active and passive components.

### Specifications Summary

#### HP 8508A and 70138A with HP 85081B High Impedance Input Module

(\* specifications apply to HP 85082A 50 Ohm Input Module only)

**Frequency Range:** 100 kHz-1 GHz (300 kHz-2 GHz\*)

**Maximum Input:** 2V peak ac (+16 dBm\*), ±50V dc

**A (ref) Channel minimum:** 10mV (-47 dBm\*), 100 kHz-300 kHz  
1 mV (-47 dBm\*), 300kHz-3MHz 300µV, 3MHz-1GHz  
(-57dBm, 3MHz-2GHz\*)

**B Channel noise level:** 10µV (-87 dBm\*)

**Input Crosstalk:** >100 dB, 1 MHz-500 MHz >80 dB, 500 MHz-1 GHz (>70 dB, 1 GHz-2 GHz\*)

#### Magnitude Accuracy

**Absolute Accuracy** +1/-1.5 dB, 100 kHz-300 kHz  
(A, B 100 mV, 15-30° C) ±.5 dB, 300 kHz-1 MHz

±.3 dB, 1 MHz-100 MHz  
±.6 dB, 100 MHz-300 MHz  
±1 dB, 300 MHz-1 GHz  
(±1 dB, 300 MHz-1.5 GHz\*)  
(+1/-2 dB, 1.5 GHz-2 GHz\*)

**Ratio Accuracy** ±1 dB, 100 kHz-300 kHz  
(A, B 100mV, 15-30° C) ±.4 dB, 300 kHz-1 MHz  
±.2 dB, 1 MHz-100 MHz  
±.4 dB, 100 MHz-300 MHz  
±.6 dB, 300 MHz-1 GHz  
(±.6 dB, 300 MHz-1.5 GHz\*)  
(±1 dB, 1.5 GHz-2 GHz\*)

#### Phase Accuracy

(A, B 100mV, 15-30 C)

±4°, 300 kHz-1 MHz  
±1°, 1 MHz-100 MHz  
±4°, 100 MHz-300 MHz  
±6°, 300 MHz-1 GHz  
(±6°, 300 MHz-1.5 GHz\*)  
(±12°, 1.5 GHz-2 GHz\*)

**Search and Lock Time:** Lockup (within one range): 40mS, frequencies up to 3 MHz, 20 mS, frequencies greater than 3MHz.

**General:** HP 8508A only

**Power:** 100, 120, 220 or 240V +5/-10%, 48 to 440Hz, 40VA.

**Size:** 133H x 425.5W x 473.3mmD (5.25" x 16.75" x 18.65") Opt 001 158.8H x 524.5 W x 524.5mmD (6.25" x 19.75" x 20.65").

**Weight:** net, 8.1Kg; shipping, 11Kg. Option 001: net, 9.4Kg; shipping 12.5Kg.

#### HP 11570A Accessory Kit

**50 Ω Tee:** For monitoring signals on 50 Ω transmission line. Kit contains two each with type N female connectors.

**50 Ω Power Splitter:** All connectors type N female.

**HP 908A 50 Ω Termination:** For terminating 50 Ω coaxial systems in their characteristic impedance. Kit contains two each with type N male connectors.

**HP 11512A Short:** Type N male.

#### HP 85089A Grounding Clip

The HP 85089A grounding clip fits over the probe tip of the HP 85081B to provide a ground return when making in-circuit measurements. It also acts as a shorting bar when the probe is not in use to reduce susceptibility to electrostatic damage.

#### Ordering Information

<b>HP 8508A Vector Voltmeter</b> (includes HP 85081B).	\$5,850 ☎
<b>Opt 001:</b> Add bail handle and front protective cover.	+ \$250
<b>Opt 801:</b> Adds 2 each HP 11576A 10:1 Divider and HP 10216A Isolators	+ \$630
<b>HP 70138A Vector Voltmeter</b>	\$5,930
<b>Opt 050:</b> Replace HP 85081B Input Module with HP 85082A Input Module.	\$0
<b>Opt 100:</b> Delete Input Module.	-\$1,500
<b>HP 85081B Input Module</b> (100 kHz to 1 GHz, high impedance probe inputs).	\$1,500
<b>HP 85082A Input Module</b> (300 kHz to 2 GHz, 50 Ω type N inputs)	\$1,500
<b>HP 11570A Accessory Kit</b> (measurement in 50 Ω systems with standard HP 8508A and 70138A).	\$1,100
<b>HP 85089A Grounding Clip</b>	\$10
☎ For same day shipment, call HP DIRECT at 800-538-8787	

# NETWORK ANALYZERS

## Microwave Network Analyzers, 130 MHz to 13.5 or 20 GHz

### HP 8719A, 8720B, 85162A

- 130 MHz to 13.5 or 20 GHz frequency range
- Fast-sweeping synthesized source built in
- Integrated switching s-parameter test set
- Direct save/recall to an external disk drive
- Up to 95 dB dynamic range
- Built-in accuracy enhancement

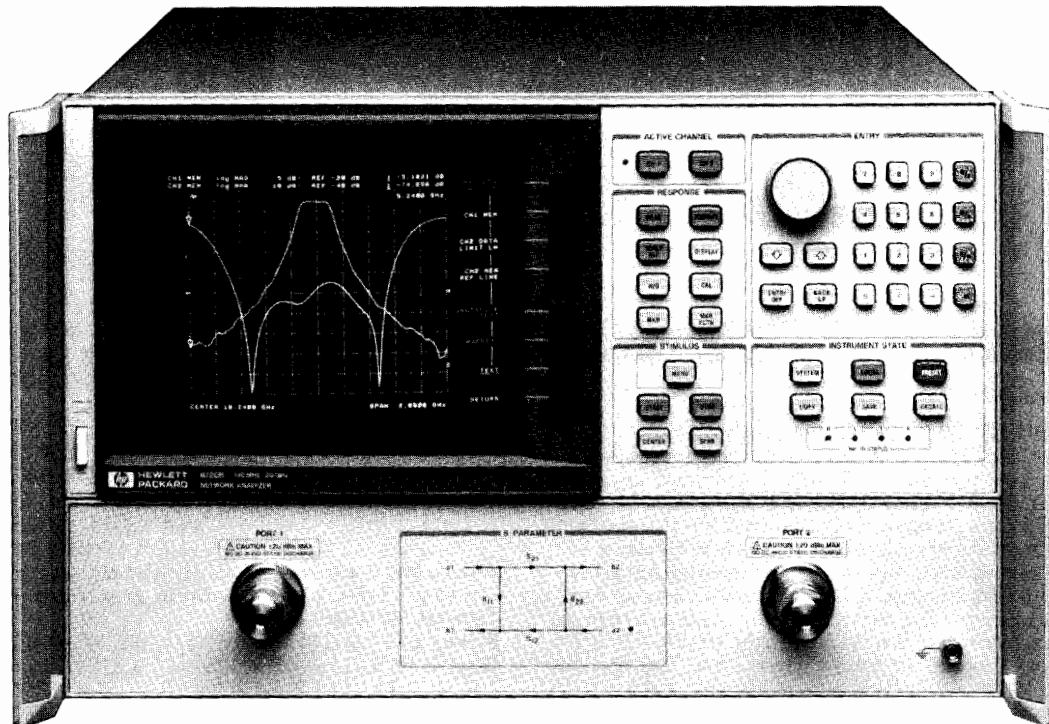

HP 8720B

### HP 8719A, 8720B Microwave Network Analyzers

The HP 8719A or 8720B microwave network analyzers characterize microwave components and networks to 13.5 or 20 GHz. These vector network analyzers include a fast-sweeping synthesized source, switching s-parameter test set, and large, full color display in a single integrated package. These compact instruments are economical and easy to use. They are ideal choices for manufacturing, incoming inspection, and final test.

#### Affordable Analyzers with Excellent Performance

The integral source is fully synthesized, even while sweeping, and it provides stability and accuracy within 10 ppm (typical). Yet, the source sweeps extremely fast: measurement update times are typically about 1 ms per point. Frequency resolution is 100 kHz standard; option 001 provides 1 Hz resolution for narrow-band or long devices.

With tuned receivers and variable-bandwidth IF filters, the HP 8719A and 8720B microwave network analyzers provide over 85 dB of dynamic range. Option 003 boosts the forward dynamic range to 95 dB; solutions to 100 dB are available. The built-in test set measures all four s-parameters (both forward and reverse) with a single connection.

A step attenuator controls incident power level from -10 to -65 dBm in 5 dB steps, and two internal tees provide bias to active devices through the test ports.

Two independent channels can display reflection and transmission characteristics at the same time. The receiver detects both magnitude and phase, and presents results in a variety of useful formats, including group delay, deviation from linear phase, complex impedance, or SWR, on rectangular, polar, or Smith charts.

Built-in vector accuracy enhancement supports calibration kits in 3.5 mm, 7 mm, and type-N connectors; a user kit supports waveguide. Choose from a simple response normalization to full 2-port error correction. And the frequency subset feature lets you zoom in on a response without recalibrating.

Time domain capability (option 010) computes and displays the DUT's response versus time or distance (instead of frequency). Use time domain to locate and quantify individual discontinuities in a network. Or apply the gating feature to remove the effects of unwanted reflections (separated in time), then view the DUT's true response versus frequency.

#### Time-Saving Productivity Features

Limit test capability makes pass/fail decisions quantitative and decisive. Define up to 22 test limits per channel, based on the specifications of your components. Tuning is faster, and testing is more consistent.

To document results without a computer, the copy feature sends the entire display to a compatible plotter or printer.

Annotate specific trace features with markers — up to four per channel, all displayed at once. Advanced marker functions track a maximum or minimum point (while tuning), or compute the delta between two markers. For bandpass filters, markers automatically determine center frequency, bandwidth, and Q.

With save/recall capability, an experienced user can define and save test configurations for each DUT. Other users can recall identical conditions later, and align/test each DUT consistently. Use five internal memory registers, or save/recall directly to an external CS80 disk drive.

#### Software

Automate the HP 8719A or 8720B microwave network analyzers with HP-IB for added capability. The HP 85162A Measurement Automation Software guides you through measurements and simplifies test configuration. You can measure transistors quickly and completely with the HP 85014C Active Device Measurements Application Pac. The software includes models to de-embed the HP 85041A transistor fixture, and also controls the bias supply. Or, you can use the HP 85165A Resonator Measurement Software to characterize SAW devices and crystal.

## HP 8719A/8720B System Performance

All specifications apply to the HP 8719A up to 13.5 GHz.

### Dynamic Range<sup>1</sup>

	Frequency range (GHz)			
	0.13 to 0.5	0.5 to 2	2 to 8	8 to 20
Transmission ( $S_{21}$ or $S_{12}$ )(standard)	70 dB	80 dB	85 dB	85 dB
Forward Transmission ( $S_{21}$ )(Option 003)	99 dB	98 dB	97 dB	95 dB
Reverse Transmission ( $S_{12}$ )(Option 003)	30 dB	55 dB	65 dB	65 dB

### Measurement Port Characteristics<sup>2</sup>

The following specifications show the residual system uncertainties (including switch repeatability) after accuracy enhancement using a full 2-port measurement calibration (including isolation) with an IF bandwidth of 10 Hz, and the specified calibration kit. Environmental temperature is  $23 \pm 3^\circ\text{C}$ .

**Calibration Kit: HP 85052B** (3.5 mm, male and female lowband and sliding loads)

	Frequency Range			
	0.13 to 0.5 GHz	0.5 to 2 GHz	2 to 8 GHz	8 to 20 GHz
Directivity	40 dB	40 dB	40 dB	40 dB
Source Match	30 dB	30 dB	30 dB	30 dB
Load Match	35 dB	35 dB	30 dB	30 dB
Reflection Tracking	$\pm 0.10$ dB	$\pm 0.10$ dB	$\pm 0.10$ dB	$\pm 0.20$ dB
Transmission Tracking	$\pm 0.10$ dB <sup>6</sup>	$\pm 0.10$ dB <sup>6</sup>	$\pm 0.12$ dB	$\pm 0.15$ dB

**Calibration Kit: HP 85052D** (3.5 mm, male and female broadband precision fixed load)

	Frequency Range			
	0.13 to 0.5 GHz	0.5 to 2 GHz	2 to 8 GHz	8 to 20 GHz
Directivity	40 dB	40 dB	38 dB	36 dB
Source Match	30 dB	30 dB	30 dB	29 dB
Load Match	35 dB	35 dB	30 dB	30 dB
Reflection Tracking	$\pm 0.10$ dB	$\pm 0.10$ dB	$\pm 0.10$ dB	$\pm 0.20$ dB
Transmission Tracking	$\pm 0.10$ dB <sup>6</sup>	$\pm 0.10$ dB <sup>6</sup>	$\pm 0.12$ dB	$\pm 0.15$ dB

### System Accessories

	3.5 mm	7 mm <sup>3</sup>	Type N <sup>3</sup>
Test port cables	Standard	HP 85131C/D	HP 85132C/D
	Flexible <sup>5</sup>	HP 85131E/F	HP 85132E/F <sup>4</sup>
Adapter sets	HP 85130D	HP 85130B	HP 85130C
Calibration kits	Standard (sliding loads)	HP 85052B	HP 85050B
	Economy (fixed loads)	HP 85052D	HP 85050D
Verification kits	HP 85053B	HP 85051B	HP 85055A

<sup>1</sup>Limited by maximum output power and system noise floor. Specified for an IF bandwidth of 10 Hz, using a full 2-port measurement calibration (including an isolation calibration performed with an averaging factor of 16).

<sup>2</sup>Crosstalk, after an isolation calibration, is below the system noise floor and can be ignored.

<sup>3</sup>HP 85130B/C Special Adapter Sets required if devices with 7 mm or Type N connectors are to be connected directly to the HP 8719A/HP 8720B's test ports.

<sup>4</sup>Use the cables recommended for 7 mm devices. Precision 7 mm to Type N adapters are included in the HP 85054B/D Type N calibration kits.

<sup>5</sup>Standard cables are warranted for 90 days. Flexible cables carry a standard one-year warranty.

<sup>6</sup>With Option 003, reverse transmission tracking and maximum Port 2 power level are reduced.

## General Characteristics

### Source Frequency Characteristics

**Range:** HP 8719A, 130 MHz to 13.5 GHz

HP 8720B, 130 MHz to 20.0 GHz

**Resolution:** 100 kHz (1 Hz with Option 001)

**Stability:** typically  $\pm 7.5$  ppm @  $0^\circ$  to  $55^\circ\text{C}$

typically  $\pm 3$  ppm/year

**Accuracy:** 10 ppm @  $25^\circ \pm 3^\circ\text{C}$

**Output characteristics** (at test ports,  $25^\circ \pm 3^\circ\text{C}$ )

**Power range:**  $-10$  to  $-65$  dBm in 5 dB steps<sup>6</sup>

**Power level:**  $-10$  dBm  $\pm 3$  dB<sup>6</sup>

**Harmonics:**  $< -15$  dBc @  $-10$  dBm (typical)

### Test ports

**Connector type:** 3.5 mm (male)

**Impedance:** 50 ohms nominal

**Switch type:** Mechanical

**Switch lifetime:**  $> 3$  million cycles (typical)

**Maximum input level:**  $+20$  dBm

**DC bias:** 500 mA, 40 VDC maximum

### Rear Panel Connectors

#### External reference frequency input:

**Frequency:** 1, 2, 5, and 10 MHz;  $\leq \pm 200$  Hz at 10 MHz

**Level:**  $-10$  dBm to  $+20$  dBm, typical

**Impedance:** 50 ohms

**External trigger:** Triggers start of sweep on a negative TTL transition or contact closure to ground.

**External AM auxiliary input:** 0 to 10 volts ( $-1$  dB/volt) into a 10 kohm resistor, 5 kHz max.

**Auxiliary voltage input:**  $-10$  to  $+10$  V

#### IO interconnect:

**Type:** DB-25

**Output:** Standard LS TTL output (active high logic) on pin 17 indicative of PASS/FAIL status during limit testing. Output voltage remains at  $+5$  Vdc (nominal) until a FAIL condition occurs. Remains at 0 Vdc until a PASS condition occurs.

### HP 85162A Measurement Automation Software

The HP 85162A Measurement Automation software is designed specifically to operate on an HP 9000 series 200 or 300 computer with BASIC 3.0 or higher. The software complements the HP 8720A microwave network analyzer, providing calibration, measurement, and data output capabilities with a minimum of operator interaction.

#### Ordering Information

**HP 8719A Network Analyzer** (130 MHz to 13.5 GHz) \$44,000

Opt W30 Extended Repair Service. See page 723. +\$1,100

Opt W31 On-site Repair Service. See page 723. +\$1,980

Opt W32 Calibration Service. See page 723. +\$665

**HP 8720B Network Analyzer** (130 MHz to 20.0 GHz) \$55,000

Opt W30 Extended Repair Service. See page 723. +\$1,375

Opt W31 On-site Repair Service. See page 723. +\$2,500

Opt W32 Calibration Service. See page 723. +\$665

Following options available for both HP 8719A and 8720B:

Opt 001 1 Hz frequency resolution +\$9,500

Opt 003 High forward dynamic range \$0

Opt 010 Time Domain Capability +\$9,000

Opt 802 add HP 9122C Dual Disc Drive, HP 10833A cable +\$1,495

Opt 830 add HP 85052D Cal Kit, HP 85131E cable +\$5,950

Opt 913 Rack Mount Kit (product # 5062-4071) +\$40

**HP 85162A Measurement Automation Software**

Requires BASIC 3.0 or above and 2 Mbytes of RAM \$1,500

Must select media option (no charge):

Opt 630 for 3.5 in. disk media \$0

Opt 655 for 5.25 in. disk media \$0

☎ For same day shipment call HP Direct 800-538-8787

# NETWORK ANALYZERS

## Microwave Network Analyzers, 45 MHz to 110 GHz

### HP 8510 Series

- 45 MHz to 110 GHz frequency range
- Real-Time error-corrected measurements
- 60 dB effective directivity and source match

- 80 dB to 100 dB dynamic range
- 0.001 dB, 0.01 degree, 0.01 nanosecond measurement resolution
- Time domain analysis

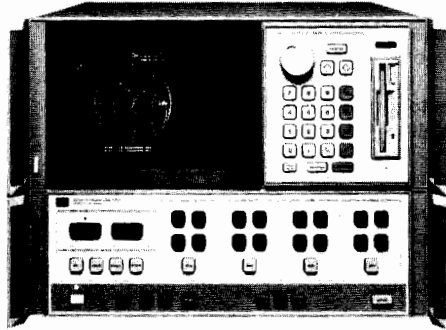

HP 8510C



### HP 8510 Series Microwave Network Analyzers

The HP 8510 series microwave vector network analyzers provide a complete solution for characterizing the linear behavior of either active or passive networks over the 45 MHz to 50 GHz frequency range. A complete system comprises the HP 8510C network analyzer, an S-parameter test set, and a compatible RF source. For millimeter-wave measurement needs, complete systems operating to 110 GHz can be configured. For compatible lightwave measurement products, see page 333

Measurement results can be displayed on a large, color CRT on one of two independent, yet identical, channels. The channels may be displayed individually, or simultaneously, with results presented in either log/linear magnitude, phase, or group delay format on rectangular or polar coordinates. Direct measurement of impedance is possible with the Smith chart format. The value and frequency of the data can be read with one of five independent markers. The CRT display can be copied directly to a plotter, such as the HP 7440A, 7475A or 7550. For increased productivity a plotter buffer is available. Also, a list of measurement data can be sent to an external printer such as the HP 2225A.

Powerful measurement enhancement functions are also available. Data averaging can be employed to narrow the effective receiver IF bandwidth, extending dynamic range and increasing signal-to-noise ratio. Trace smoothing aids in the interpretation of measurement results and is used to control the aperture of group delay measurements. Electrical length measurements are accomplished with the electrical delay function.

Built-in storage provides the capability to save and recall up to eight different front panel states, eight separate calibrations, and eight separate measurements in nonvolatile memory. Extension of the internal storage capacity is possible via the built-in 3 1/2" disc drive or an external disc drive.

### High Performance

Along with the capability to completely characterize a microwave network with a single connection over the extremely broad 45 MHz to 50 GHz frequency range, the HP 8510 system offers wide dynamic range. Depending on the test set used, 80 dB to 100 dB of dynamic range is available. The precision IF processing and detection system contributes as little as  $\pm 0.05$  dB and  $\pm 0.5$  degree measurement uncertainty at a level of 50 dB below the reference. Meaningful resolutions of 0.001 dB, 0.01 degree, and 0.01 nanosecond are easily available.

### Real Time Error Correction

The HP 8510's built-in, high speed computer provides the capability to characterize and effectively remove the impact of systematic errors through accuracy enhancement techniques. Effective directivity and source match can be improved to as much as 60 dB. The data processing speed of the system is such that a fully error-corrected, 401 point trace of data is updated in under one second. This virtual "real time" display of error-corrected data means that you can easily adjust your test device while it's being measured, with the assurance that you are viewing the data at the highest possible accuracy.

### Time Domain Analysis

The HP 8510 (with option 010) has the capability of displaying the time domain response of a network, obtained by computing the Inverse Fourier Transform of the frequency domain response. The time domain response displays the reflection coefficient of the network versus time, which displays the magnitude and location of each individual discontinuity, or else the transmission coefficient versus time, which displays each individual transmission path.

### Pulsed-RF Measurement Capability.

For the measurement of pulsed-RF devices the HP 8510C can be equipped with wideband IF detectors (Option 008). When configured with a compatible test set (HP 85110A), the system can measure pulse widths as narrow as 1 usec on devices with output power up to 20W (CW). Measurement formats include magnitude and phase versus frequency or time (pulse profile).

### RF Sources

The recommended system source for the HP 8510C is the HP 8360 synthesized sweeper. It provides 1 Hz frequency resolution, phase-locked narrowband sweeps, and fully synthesized start frequencies for broadband ramp sweeps. All HP 8360-series synthesized sweepers are compatible with the HP 8510C. However, the HP 83621A (20 GHz), 83631A (26 GHz) and 83651A (50 GHz) models are optimized for HP 8510C system operation. Both the HP 8340-series synthesized sweeper and HP 8350B-series sweep oscillators are also compatible with the HP 8510C.

### System Rack

#### HP 85043A System Rack Kit

The HP 85043A system rack stands 123.7 cm (48.7") high, 60 cm (23.6") wide, and 80 cm (31.5") deep. Complete with support rails and ac power distribution (suitable for 50 to 60 Hz, and 110-240 Vac), it includes rack mounting hardware for all instruments. Therman design is such that no rack fan is needed.

### System Software

#### HP 85161A measurement automation software

The HP 85161A measurement automation software provides a more simplified and flexible user interface to the HP 8510C system. The program leads the operator through the measurement sequence one step at a time, from system setup and calibration, to device measurement and hardcopy output. Complete measurement configurations can be saved to disc for later recall. Also, data printout formats can be customized by the operator.

The HP 85161A software is designed for use with HP 9000 Series 200 or 300 computers and the BASIC operating system (3.0 or higher).

### Ordering Information

	Price
HP 8510C network analyzer	\$34,900
Opt 008 pulsed-RF measurement capability.	+\$10,230
Opt 010 time domain capability	+\$10,000
Opt W31 on-site repair service, see page 723	+\$1,995
HP 85043A system rack kit	\$3,000
HP 85161A measurement automation software	\$1,550
Option 630 3 1/2" disk media	\$0
Option 655 5 1/4" disk media	\$0



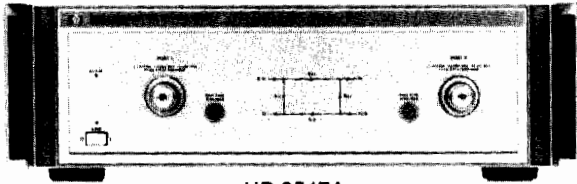

HP 8517A

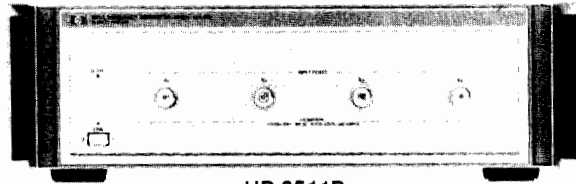

HP 8511B

### S-Parameter Test Sets

Several S-parameter test sets are available for the HP 8510C network analyzer for broadband coaxial measurements from 45 MHz to 50 GHz. The HP 8514B, 8515A, 8516A, and 8517A test sets have a dual port architecture which develops a separate reference channel for each incident port. RF switching is done with a single built-in electronic switch. For active device measurements, the test sets include the ability to apply DC bias (external) to the test port center conductors. Also available are two 90 dB step attenuators (60 dB in the HP 8516A/8517A) which allow control of the port 1 and port 2 signal levels.

### Pulsed-RF Measurement Test Set

The HP 85110A test set is specially configured for operation in pulsed-RF measurement systems (HP 85108). Four 90 dB step attenuators protect each input of the fundamentally-mixed down converter to allow measurement of test devices with output power of 20 Watts CW.

### High Dynamic Range Configurations

For the HP 8514B and 8516A test sets two alternate coupler configurations are available. The standard configuration is symmetrical and has identical dynamic range performance in both forward (S21) and reverse (S12) transmission measurements. The port 1 step attenuator allows reduction of the port 1 output power for forward measurements, and the port 2 attenuator allows reduction of the port 2 output power for reverse measurements.

With the Option 003 configuration, the port 2 coupler is reversed. For forward measurements, the port 2 signal is sampled directly through the main arm of the port 2 coupler. Since coupling loss is removed, dynamic range is increased in the forward direction. Since the port 2 step attenuator is in-line with the port 2 sampler, the power incident on port 2 may be reduced. With Option 003, up to 1 Watt may be input into port 2.

### Test Set General Information

	HP 8514B	HP 8515A	HP 8516A	HP 8517A	HP 85110A
Frequency range (GHz)	0.045 to 20	0.045 to 26.5	0.045 to 40	0.045 to 50	0.045 to 20
Test ports (port 1 or 2): Nominal operating power level (dBm)	0 to -5	-5 to -25		-10 to -20	
Test Port Connector type	3.5 mm (M)		2.4 mm (M)	2.4mm (M)	3.5mm (M)
Impedance DC bias	50 ohm nominal 500 mA, 40 Vdc maximum				
Attenuation range (incident signal)	0 to 90 dB, in 10 dB steps (0 to 60 dB for HP 8516A)				
Prices	\$1270	\$1595	\$1395		\$1150

### Frequency Converters

With the HP 8511A (26.5 GHz) and 8511B (50 GHz) Frequency Converters, the HP 8510 becomes a general purpose four-channel magnitude/phase receiver. Add your own power splitters for transmission measurements, and bridges or directional couplers for reflection measurements. Since one input is used for system phase-lock, the other three inputs are available for measurements of multi-port devices, subsystems, and antennas. All four inputs have precision 3.5 mm (HP 8511A) or 2.4 mm (8511B) connectors.

### Multiple Test Set Operation

A single HP 8510C system may be configured with two test sets. In this configuration, the test sets have different addresses, and the user may select between them from the front panel of the HP 8510 without reconnections. This capability is useful, for example, when combining a microwave coaxial test set with a millimeter-wave test set in the same HP 8510 system.

IF switching (option 001). In the multiple test set configuration, the 20 MHz IF signal is daisy-chained from the test sets to the HP 8510. This capability requires test set option 001 in one of the two test sets.

The RF signal must be routed to the desired test set using an HP 33311C coaxial RF switch and an HP 11713A switch driver. The switch driver is controlled automatically by the HP 8510C over the 8510 system interface bus.

### Ordering Information

	Price
<b>HP 8511A Frequency Converter</b>	\$19,700
Opt 001 Add IF switching	+ \$2,600
Opt W30 Extended repair service see page 723	+ \$405
Opt W31 On-site repair service see page 723	
<b>HP 8511B Frequency Converter</b>	TBA
Opt 001 Add IF switching	TBA
Opt W30 Extended repair service	TBA
Opt W31 On site repair service	TBA
<b>HP 8514B S-Parameter Test Set</b>	\$28,000
Opt 001 Add IF switching	+ \$2,600
Opt 002 Delete step attenuators and bias tees	- \$6,500
Opt 003 High forward dynamic range	\$0
Opt W30 Extended repair service see page 723	+ \$455
Opt W31 On-site repair service see page 723	
<b>HP 8515A S-Parameter Test Set</b>	\$39,000
Opt 001 Add IF switching	+ \$2,600
Opt 002 Delete step attenuators and bias tees	- \$7,000
Opt W30 Extended repair service see page 723	+ \$525
Opt W31 On-site repair service see page 723	
<b>HP 8518A S-Parameter Test Set</b>	\$40,800
Opt 001 Add IF switching	+ \$2,600
Opt 002 Delete step attenuators and bias tees	- \$7,000
Opt 003 High forward dynamic range	\$0
Opt W30 Extended repair service see page 723	+ \$885
Opt W31 On-site repair service see page 723	
<b>HP 8517A S-Parameter Test Set</b>	TBA
Opt 001 Add IF switching	TBA
Opt 002 Delete step attenuators and bias tees	TBA
Opt W30 Extended repair service. See page 723	TBA
Opt W31 On-site repair service See page 723	TBA
<b>HP 85110A Pulsed-RF S-Parameter Test Set</b>	\$55,000
Opt 001 Add IF switching	+ \$2,500
Opt W31	+ \$1,935

# NETWORK ANALYZERS

## Millimeter-wave Measurement System

### HP 8510 Series

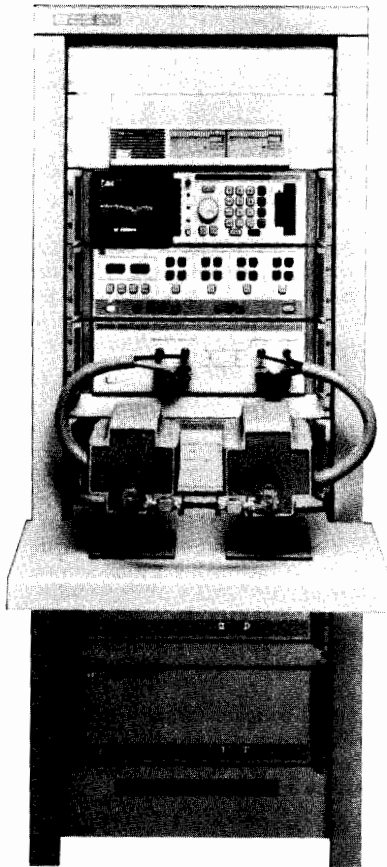

The HP 85106B millimeter-wave network-analyzer system from Hewlett-Packard Company characterizes all four S-parameters of components in the 33 to 50 GHz, 40 to 60 GHz, 50 to 75 GHz and 75 to 110 GHz waveguide bands.

The HP 8510C system can be easily configured for making measurements at millimeter-wave frequencies. Hewlett-Packard offers hardware for configuring systems in the 26.5 to 40 GHz, 33 to 50 GHz, 40 to 60 GHz, 50 to 75 GHz, and 75 to 110 GHz waveguide bands. These S-parameter configurations allow both forward and reverse measurements to be made with a single connection to the device under test. The greatest convenience and highest accuracy is assured through the TRL (Thru-Reflect-Line) calibration technique, which is now possible with a millimeter-wave S-parameter configuration.

#### HP 85106B Millimeter-wave Network Analyzer Subsystem

The HP 85106B millimeter-wave network analyzer subsystem includes an HP 8510C network analyzer, an HP 85105A millimeter-wave controller, an HP 83621A synthesized source, and an HP 8350B/83540A source (LO), all mounted in a single bay rack with extendable worksurface. The system set-up disk makes the retrieval of system states fast and easy. System installation at your facility and one year on-site service are included with the HP 85106B at no additional cost. Two HP 85104A series test set modules are required to complete the system. Precision calibration kits and verification kits are also available for these waveguide bands.

The HP 85106B can be configured as a combination microwave/millimeter-wave S-parameter system with Option 001. This option adds an HP 8516A microwave test set, HP 85133D test port

return cable set, HP 85056A calibration kit and appropriate cabling for convenient switching between mm-wave operation and microwave operation with no re-connections required.

The HP 8510B's external phase-locked control allows the use of the economical HP 8350B sweep oscillator as the local oscillator (LO) source. However, a synthesizer can also be used as the LO source when faster measurement speeds are desired. Option 002 substitutes an HP 83621A synthesized source for the HP 8350B/83540A source as the local oscillator.

Option 010 adds time domain capability to the HP 8510C for transferring frequency domain data to the time domain for observing the effects of impedance discontinuities as a function of distance or time.

#### HP 85104A Series Test Set Modules

An HP Q/U/V/W 85104A test set module contains all of the necessary waveguide hardware (frequency multiplier, isolators, directional couplers and harmonic mixers) compactly integrated into one box. Any pair of the test set modules can be connected to the HP 85105A millimeter-wave controller for S-parameter millimeter-wave measurement capability. These modules are easy to maneuver and make the system extremely simple to set-up.

#### HP 11644A Series Calibration Kits

Each HP Q/U/V/W 11644A precision calibration kit contains two straight waveguide test port sections with precision flanges, a flush short circuit, a precision quarter-wavelength shim, and a sliding or fixed load termination. In addition to providing the "offset" for the offset short and offset load, the shim is also used as the "line" standard for a TRL calibration. The standards in the kit allow you to take full advantage of the built-in accuracy enhancement and data processing features of the HP 8510C.

#### HP 11645A Series Verification Kits

Each HP Q/U/V/W 11645A verification kit contains a standard section, mismatch section, and a 20 dB and 50 dB attenuator. The devices in the kit are shipped with nominal data and uncertainties traceable to the US National Institute of Standards and Technology (NIST).

#### Ordering Information

	<b>Price</b>
<b>HP 85106B</b> mm-Wave Network Analyzer Subsystem	\$122,500
<b>Opt 001</b> Add Microwave Test Set (HP 8516A) and 2.4 mm Accessories	+\$51,650
<b>Opt 002</b> Synthesized LO (HP 83621A) for the fastest measurement speed	+\$18,900
<b>Opt 010</b> add Time Domain Capability to the HP 8510B	+\$10,000
<b>Test Set Modules (order 2 each)</b>	
<b>HP Q85104A</b> WR-22 (33 to 50 GHz) Test Set Module	\$28,000
<b>HP U85104A</b> WR-19 (40 to 60 GHz) Test Set Module	\$29,000
<b>HP V85104A</b> WR-15 (50 to 75 GHz) Test Set Module	\$32,000
<b>HP W85104A</b> WR-10 (75 to 110 GHz) Test Set Module	\$35,000
<b>Calibration Kits</b>	
<b>HP Q11644A</b> WR-22 (33 to 50 GHz) Calibration Kit	\$3,850
<b>HP U11644A</b> WR-19 (40 to 60 GHz) Calibration Kit	\$4,200
<b>HP V11644A</b> WR-15 (50 to 75 GHz) Calibration Kit	\$4,200
<b>HP W11644A</b> WR-10 (75 to 110 GHz) Calibration Kit	\$4,400
<b>Verification Kits</b>	
<b>HP Q11645A</b> WR-22 (33 to 50 GHz) Verification Kit	\$4,750
<b>HP U11645A</b> WR-19 (40 to 60 GHz) Verification Kit	\$4,750
<b>HP V11645A</b> WR-15 (50 to 75 GHz) Verification Kit	\$4,750
<b>HP W11645A</b> WR-10 (75 to 110 GHz) Verification Kit	\$4,750

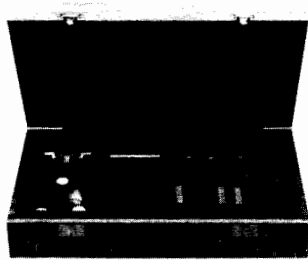

HP 85041A

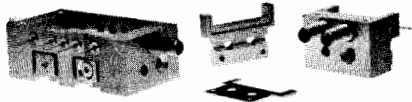

HP 83040A

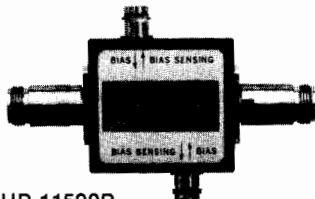

HP 11590B



HP 11612A

### Active Device Test

Hewlett-Packard offers an extensive array of accessories designed for the needs of active device test and measurement, including fixtures, bias supplies, bias networks, and application software.

#### HP 85041A Transistor Test Fixture Kit

The HP 85041A transistor test fixture (TTF) kit is a comprehensive measurement system for testing and characterizing stripline packaged microwave transistors. Only useful when used with the HP 85014B active device measurement software.

**Frequency Range** dc to 18 GHz

**Transistor Package Inserts** 70 mil and 100 mil

**Verification Devices** Short and through circuits

**Connectors** precision 7 mm

**Accessories Supplied** fixture stand, torque tool, tweezers, and lid opening tool

#### HP 83040A Series Modular Microcircuit Package

The new HP 83040 system bridges the gap between custom microcircuit packages and precision test fixtures. This versatile design tool provides a flexible, modular platform for breadboard design and test. Characterize and store circuit modules for easy integration into CAE models. Immediate availability eliminates mechanical design and fab queues, streamlining design cycle times.

- Compatible with many vector network analyzer calibration methods
  - 0.254-mm (0.010-in) and 0.635-mm (0.025-in) substrates
  - Excellent performance to 26.5 GHz (0.254-mm substrates)
- See page 360 for complete description and ordering information

#### HP 11608A Transistor Fixture

**Function:** provides the capability of completely characterizing stripline transistors. A through-line microstrip and bolt-in grounding structure machineable by customer is included.

**Frequency range** dB to 12.4 GHz.

**Reflection coefficient** <0.05, dc to 4 GHz; <0.07, 4.0 to 8.0 GHz; >0.15, 8 to 12.4 GHz.

**Package Styles**

**Opt 003** 0.205 inch diameter packages.

**Calibration references** option 003 only, short circuit termination and a 50-ohm through-section.

**Connectors** APC-7 hybrid.

**Weight** net, 0.9 kg (2 lb); shipping, 1.4 kg (3 lb.).

**Size** 25 H x 143 W x 89 mm D (1" x 5.63" x 3.5").

### Bias Networks

Bias networks are available for applying DC bias to the center conductor of a coaxial line which can be connected to a device under test. The bias network also provides a DC block to the RF input port.

Bias Network	HP 11590B	HP 11590B Opt 001	HP 11612A	HP 11612B
Frequency Range (GHz)	.1-12.4	.1-18	.045-26.5	.045-50
Connectors	Type N (f)	7 mm	3.5 mm (f)	2.4 mm (f)
RF Input	Type N (f)	7 mm	3.5 mm (m)	2.4 mm (f)
RF Output	BNC (f)	BNC (f)	SMB snap-on (m)*	SMB snap-on (m)*
DC Bias				
Insertion Loss (max)	0.8 dB	0.8 dB, .1-12.4 GHz 1.2 dB, 12.4-18 GHz	0.8 dB, .045-12.4 GHz 1.3 dB, 12.4-26.5 GHz	0.8 dB, .045-12.4 GHz 1.3 dB, 12.4-26.5 GHz 26.5-50 GHz
Return Loss (min)	19 dB	19 dB, .1-12.4 GHz 14 dB, 12.4-18 GHz	20 dB, .045-8 GHz 18 dB, 8-18 GHz 14 dB, 18-26.5 GHz	20 dB, .045-8 GHz 18 dB, 8-18 GHz 14 dB, 18-26.5 GHz 10 dB, 26.5-50 GHz
Bias current (max)	500 mA	500 mA	500 mA**	500 mA
Bias voltage (max)	100V	100V	40V	40V

\*Cable included, SMB(f) to BNC(m).

\*\*Option 001 provides for 2 Amps maximum bias current over the 400 MHz to 26.5 GHz frequency range. Higher bias currents may be applied with pulsed operation.

### HP 11635A Bias Decoupling Network

The HP 11635A bias decoupling network is a recommended accessory for prevention of bias oscillations when biasing microwave bipolar transistors with any HP bias network or s-parameter test set. Installing the HP 11635A between the bias supply and the base bias network prevents low frequency oscillations.

### Application Software

Hewlett-Packard offers application software packages that complement the HP 8510 system providing automated calibration and measurement capability. Software is available for HP Series 200/300 desktop computers using BASIC 2.0, 3.0, 4.0 or 5.0 operating systems on both 3 1/2" and 5 1/4" disc media.

### HP 85014B/C Active Device Measurement Application Pac

The HP 85014B/C software pac provides the capability for measurement of RF and microwave transistors (HP 85014B for the HP 8510C and HP 85014C for HP 8719A/8720B). Features include automated device biasing with the HP 6626A precision power supply or HP 8717B bias supply, system calibration, and de-embedding of s-parameters when using the HP 85041A transistor test fixture. It is also usable with other HP transistor fixtures as well as user-designed fixtures. Plotted and listed output of device S, H, Y, and Z parameters, as well as the device amplifier summary and termination summary are provided. Also available is the capability to store and retrieve s-parameter data in formats suitable for computer-aided-design applications.

### Ordering Information

	Price
HP 85041A Transistor Test Fixture	\$5,800
HP 11590B Bias Network	700
HP 11612A Bias Network	825
Opt 001 2 Amps maximum bias current	+175
HP 11612B Bias Network	1,025
HP 11635A Bias Decoupling Network	275
HP 85014B/C Active Device Measurement Software	3,100
HP 11608A Transistor Fixture Customer Machineable	2,000
Opt 003 0.205 inch diameter Package Style	+500

# NETWORK ANALYZERS

## Microwave Network Analyzer Accessories

### HP 8510, 8719/8720 Series



HP 85050C

#### Microwave Network Analyzer Accessories

A wide range of accessories is available for both the HP 8719A/8720B and the HP 8510C series network analyzers, including calibration kits, verification kits, cables, and adapters for 7 mm, 3.5 mm, Type N and 2.4 mm connector interfaces. The standards used in the 3.5 mm, Type N and 2.4 mm connectors use the precision slotless connector (PSC-3.5, PSC-N and PSC-2.4).

#### Calibration Kits

Error-correction procedures require that the systematic errors in the measurement system be characterized by measuring known devices (standards) on the system over the frequency range of interest. All network analyzer calibration kits contain precision standard devices to characterize the systematic errors of the HP 8719A/8720B or 8510C network analyzer system.

The calibration kits also contain adapters to change the sex of the test port, connector gages for verifying and maintaining the connector interface, and a torque wrench for proper connection. Each kit contains standards definitions contained on disc for the HP 8510C. (These definitions are already included in the HP 8719A/8720B.)

#### Verification Kits

Measuring known devices, other than the calibration standards, is a straightforward way of verifying that the network analyzer system is operating properly. Hewlett-Packard offers verification kits that in-

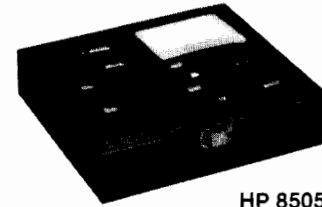

HP 85053B

clude precision airlines, mismatch airlines and precision fixed attenuators. Traceable measurement data for all devices is shipped with each kit on disc.

Verification kits may be recertified by Hewlett-Packard. This recertification includes a new measurement of all standards, as well as new data and uncertainties. Certification in compliance with MIL-STD 45662A is also available.

#### Verification Kit Summary

Verification Kit	Connector Type	Frequency Range (GHz)	Price
85051B	7 mm	.045-18	\$3,100
85053B	3.5 mm	.045-26.5	\$3,100
85055A	Type N	.045-18	\$3,100
85057B	2.4 mm	.045-50	\$4,600
R11645A	WR-28	26.5-40	\$4,750
Q11645A	WR-22	33-50	\$4,750
U11645A	WR-19	40-60	\$4,750
V11645A	WR-15	50-75	\$4,750
W11645A	WR-10	75-110	\$4,750

#### Calibration Kit Summary

Calibration Kit	Connector Type	Frequency Range (GHz)	Performance Summary		Description	Price
			Directivity/Source Match at Fmax w/8719A/8720B	Match at Fmax w/8510C		
85050B	7 mm	.045-18	45/30	52/41	Contains open and short circuits and fixed and sliding terminations.	\$4,700
85050C	7 mm	.045-18	n/a	60/60	Contains standards for TRL calibration on HP 8510B, including precision airline. Also contains open and short circuit and fixed termination.	\$5,600
85050D	7 mm	.045-18	36/30	40/35	Economy kit. Contains open and short circuits and precision-fixed termination. No gages included.	\$2,050
85052B	3.5 mm	.045-26.5	40/30	44/31	Contains open and short circuits (m and f) and fixed and sliding terminations (m and f), and in-series adapters.	\$7,700
85052C	3.5 mm	.045-26.5	n/a	50/50	Contains standards for TRL calibration on HP 8510, including precision airlines. Also contains open and short circuits and fixed terminations. No gages included (see HP 11752D).	\$8,500
85052D	3.5 mm	.045-26.5	36/29	36/30	Economy kit. Contains open and short circuits (m and f) and precision fixed termination (m and f), and in-series adapters. No gages included.	\$4,100
85054B	Type N	.045-18	40/30	42/32	Contains open and short circuits (m and f) and fixed and sliding terminations (m and f), in-series adapters, and 7mm to type N (m and f) adapters.	\$8,300
85054D	Type N	.045-18	34/28	34/28	Contains open and short circuits (M and F) and broadband fixed terminations, in series adapters, and 7mm-to-type N (M and F) adapters.	\$5,050
85056B <sup>1</sup>	2.4 mm	.045-50	n/a	38/33	Contains open and short circuits (m and f) and fixed and sliding terminations (m and f), in-series adapters, and 7mm to type N (m and f) adapters.	\$9,200
85056D <sup>1</sup>	2.4 mm	.045-50	n/a	26/24	Contains open and short circuits, broadband terminations and in-series adapters. No gages included.	\$5,000
R11644A	WR-28	26.5-40	n/a	50/45	Contain flush short circuit, a precision shim used to make the offset short, and a sliding (R,Q,U) or fixed (V,W) termination. Also contain two straight sections with precision flanges.	\$3,600
Q11644A	WR-22	33-50	n/a	50/45		\$3,850
U11644A	WR-19	40-60	n/a	50/40		\$4,200
V11644A	WR-12	50-75	n/a	50/37		\$4,200
W11644A	WR-10	75-100	n/a	46/36		\$4,400

<sup>1</sup>For measurements in the K-connector, order the HP 85056A 2.4mm calibration kit and the HP 11904S adapter kit.

### Test Port Return Cables and Adapters

Test port cables and adapter sets are available for various connector types. The cable/adapter configurations are described below. All cables are designed with one end that connects directly to the special ruggedized ports of the network analyzer test set, and one end that connects to the device under test.

Special test port adapter sets are also available to convert the ruggedized ports of the network analyzer test set to the desired connector interface. Each kit contains two adapters, one male and one female.

Both the cables and the special adapters have one special female connector which is designed to connect directly to the 3.5 mm test port (2.4 mm for HP 8516A/8517A). This side of the cable or adapter can only be connected to the test set port, and cannot be mated to a standard 3.5 mm (or 2.4 mm) male connector. The male test set ports, however, can be mated to a standard 3.5 mm (or 2.4 mm) female connector.

Choose one of the configurations shown.

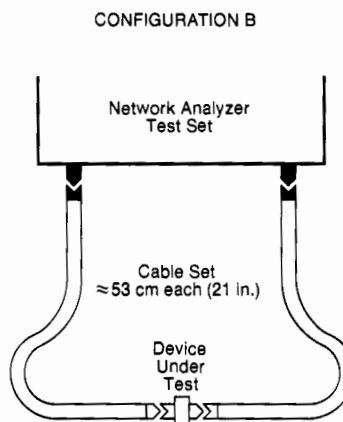
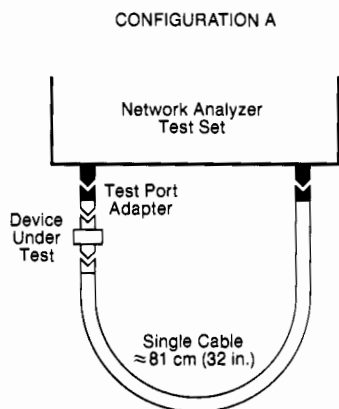

### Configuration A For HP 8719A/8720B Network Analyzer or HP 8514B/8515A Test Sets (3.5 mm test port)

	Cables/Adapters	Connector Type (on device side of cable/adapter)	Price
For 3.5 mm devices	HP 85131C Semi-rigid Cable or HP 85131E Flexible Cable	3.5 mm (f)	\$750
	HP 85130D Adapter Set <sup>a</sup>	3.5 mm (m or f)	\$990
	HP 85132C Semi-rigid Cable or HP 85132E Flexible Cable	7 mm	\$650
For 7 mm devices	HP 85130E Adapter Set	7 mm	\$1,650
	HP 85130B Adapter Set	7 mm	\$700
For Type N devices	Use 7 mm cables and the 7 mm to N adapters included in the HP 85054B calibration kit.		—
	HP 85130C Adapter Set	Type N (m or f)	\$990

a. Recommended but not required.

### Configuration A For HP 8516A/8517A Test Sets (2.4 mm test port)

	Cables/Adapters	Connector Type (on device side of cable/adapter)	Price
For 2.4 mm devices	HP 85133C Semi-rigid Cable or HP 85133E Flexible Cable Set	2.4 mm (f)	\$950
	HP 85130G Adapter Set <sup>a</sup>	2.4 mm (m or f)	\$990
	HP 85134C Semi-rigid Cable or HP 85134E Flexible Cable	3.5 mm (f)	\$750
For 3.5 mm devices	HP 85130F Adapter Set	3.5 mm (m or f)	\$1,850
	HP 85130G Adapter Set	3.5 mm (m or f)	\$990
For 7 mm devices	HP 85135C Semi-rigid Cable or HP 85135E Flexible Cable	7 mm	\$650
	HP 85130E Adapter Set	7 mm	\$1,650
	HP 85130E Adapter Set	7 mm	\$990

a. Recommended but not required.

**Configuration A.** This cable arrangement is for applications where the device under test is connected directly to the test set port. This setup offers the best mechanical rigidity for device connection. To adapt the test set port (port 1) to the device under test, choose the appropriate special adapter set. Besides converting the test port to the desired interface, these adapters also function as “test port savers” which protect the test set from damage and wear due to heavy use.

**Configuration B.** This cable arrangement is for applications where the device under test is connected between cable ends. This setup offers more flexibility when connecting to the device under test. Choose semi-rigid or flexible cables.

The cables for 3.5 mm and 7 mm devices are available as semi-rigid cables, offering excellent performance and suitable for applications where the connectors of the device under test are in-line, or as super-flexible cables which are more rugged and have a tighter bending radius, ideal for manufacturing environments. The semi-rigid cables carry a 90-day warranty, whereas the flexible cables are warranted for one full year.

### Configuration B For HP 8719A/8720B Network Analyzer or HP 8514B/8515A Test Sets (3.5 mm test port)

	Cable Set	Connector Type (on device side of cables)	Price
For 3.5 mm devices	HP 85131D Semi-rigid Cable Set or HP 85131F Flexible Cable Set	3.5 mm (one male, one female)	\$1,250
		3.5 mm (one male, one female)	\$2,850
For 7 mm devices	HP 85132D Semi-rigid Cable Set or HP 85132F Flexible Cable Set	7 mm	\$1,050
		7 mm	\$2,650
For Type N devices	Use 7 mm cables and the 7 mm to N adapters in the HP 85054B calibration kit.		—

### Configuration B For HP 8516A/8517A Test Sets (2.4 mm test port)

	Cable Set	Connector Type (on device side of cables)	Price
For 2.4 mm devices	HP 85133D Semi-rigid Cable Set or HP 85133F Flexible Cable Set	2.4 mm	\$1,650
		(one male, one female)	TBA
For 3.5 mm devices	HP 85134D Semi-rigid Cable Set or HP 85134F Flexible Cable Set	3.5 mm (one male, one female)	\$1,250
		3.5 mm (one male, one female)	\$2,850
For 7 mm devices	HP 85135D Semi-rigid Cable Set or HP 85135F Flexible Cable Set	7 mm	\$1,050
		7 mm	\$2,650

# NETWORK ANALYZERS

## Materials Measurement Systems

HP 85070A, 85071A, 85075A

- Two accessories to complete a turnkey system for characterizing materials
- Determines permittivity (dielectric constant) or permeability
- Fast, convenient, wide frequency range
- Compatible with most RF and microwave network analyzers

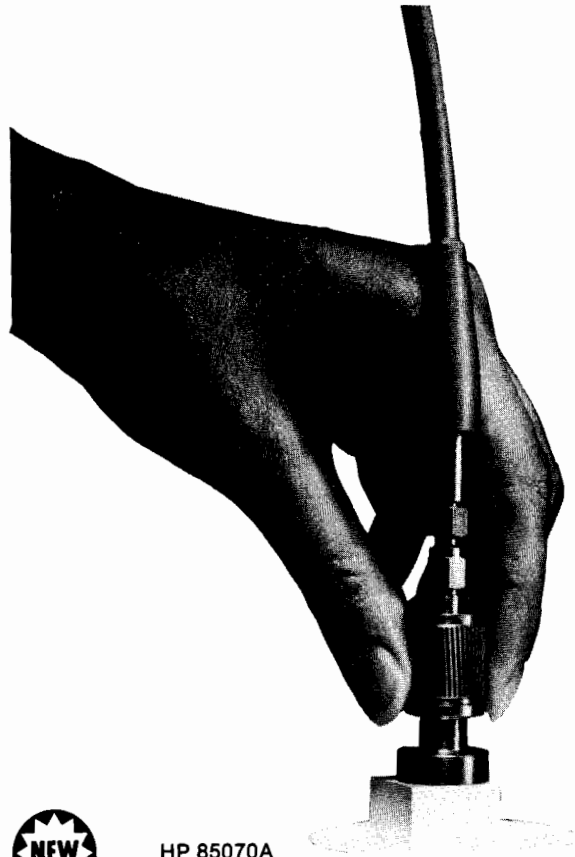

HP 85070A

### Materials Measurements

Materials have two properties that determine how they interact with electromagnetic fields:

- permittivity or dielectric constant (including loss factor)
- permeability (including magnetic losses)

There are several reasons for measuring these properties at high frequencies:

Materials are used in state-of-the-art RF/microwave components, such as substrates, capacitors, ferrites, insulators, resonators/filters, radomes, absorbers, shielding, etc. Materials should be characterized or inspected to achieve best performance while minimizing scrap.

High-power microwave processing offers unique advantages over conventional heating. The material's dielectric loss factor should be determined in order to correctly apply and optimize dielectric heating processes.

Dielectric measurements are useful analysis tools, since dielectric properties correlate directly to other material properties, such as: moisture content, phase transitions, molecular structure, polarizability, and relaxation constants.

### HP 85070A Dielectric Probe Kit

Measure dielectric properties of materials quickly and conveniently, with the HP 85070A dielectric probe kit. The measurement is nondestructive and requires no sample preparation — saving you time, trouble, and material. Dip the probe into liquids and semi-solids; there is no need for special containers. For solid materials, press the probe against a single flat face.

The system yields permittivity, dielectric constant, loss factor, loss tangent, or Cole-Cole diagrams — versus frequency — from 200 MHz to 20 GHz (depending on network analyzer and material). Accuracy is typically 5%.

### HP 85071A Materials Measurements Software

The HP 85071A software calculates materials properties from S-parameter measurements of samples loaded in a transmission line. This fixture can be either coaxial (inherently broadband) or rectangular waveguide (banded, but with simpler sample shapes).

Choose from several different models in the software to suit your material:

- Traditional method (described in Product Note 8510-3) measures both dielectric and magnetic materials (such as ferrites and absorbers), and yields both  $\epsilon_r^*$  and  $\mu_r^*$ .
- Other methods determine  $\epsilon_r^*$  of nonmagnetic materials, but do not give spurious data at periodic frequencies. One is also insensitive to the location of the sample in the fixture, so you do not need to know or carefully control position.
- Simpler 1-port method, to measure  $\epsilon_r^*$  using only reflection data.

The method yields 1-2% accuracy (typical) from 100 MHz to 110 GHz, depending on the material, fixture, and network analyzer.

### Complete Systems

A complete broad-band system includes the HP 85070A or 85071A, with a network analyzer and controller. (The HP 85071A also requires a fixture, in coax or waveguide.)

Both the HP 85070A and 85071A are compatible with all of the leading RF/microwave network analyzers: HP 8752, 8753, 8719, 8720, and 8510B. Choose the analyzer to match your frequency range needs and budget.

The software from both is available for either HP Vectra PCs (or other 100%-compatible PC-AT computers with MS-DOS), or HP 9000 series 300 BASIC controllers (with Option 300).

### Other Solutions

Many other techniques, based on RF or microwave network analyzers, offer unique advantages. For example, free space methods are non-contacting and suitable to temperature extremes.

Resonator (cavity) methods provide the highest accuracy and sensitivity to low-loss materials. Contact HP with your special needs.

At frequencies below 15 MHz, the HP 16451B dielectric test fixture (coupled with an LCR meter or impedance analyzer) provides accurate measurements of materials.

### Ordering Information

	<b>Price</b>
HP 85070A dielectric probe kit	\$3,950
Opt 300 substitute HP BASIC software	\$0
HP 85071A materials measurement software	\$4,000
Opt 300 substitute HP BASIC software	\$0
HP 85075A extra probe	\$500

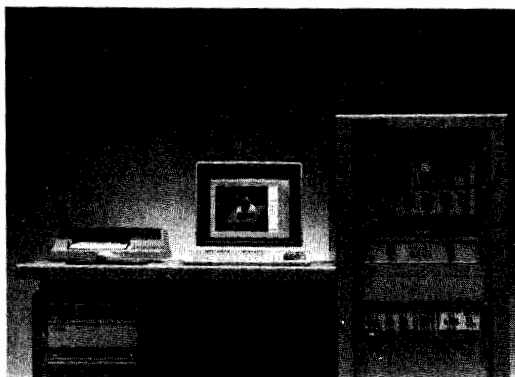

HP 85301A

### HP 85301A Antenna Measurement System

The HP 85301A Antenna Measurement System is an integrated system, which includes all of the RF measurement instrumentation, workstation controller, and system software necessary to perform far field antenna pattern measurements. The system includes installation, training, and one year on-site support.

The exact system configuration depends on performance requirements and antenna range. Two frequency converter options are available; the HP 85310A Distributed Frequency Converter and the HP 8511A Frequency Converter are summarized below. For detailed information, refer to the HP 85301A Antenna Measurement System technical data sheet and configuration guide.

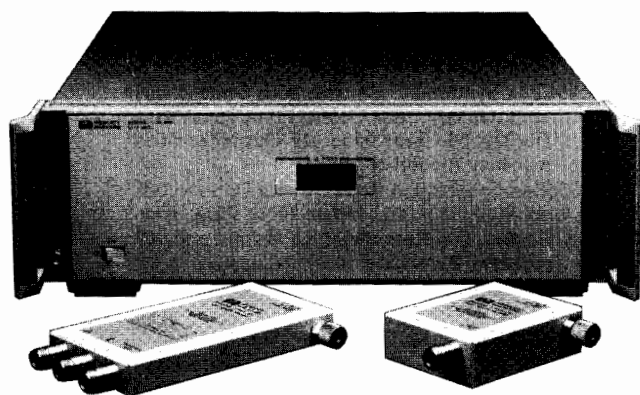

HP 85310A

### HP 85310A Distributed Frequency Converter

The HP 85310A Distributed Frequency Converter provides a high-sensitivity frequency converter which can be remoted from the HP 8510B network analyzer. The HP 85310A Distributed Frequency Converter consists of an HP 85309A LO/IF distribution unit, one HP 85320A test mixer module, and one HP 85320B reference mixer module. The standard converter provides one phase-lock reference channel and one test channel; an optional second test channel is also available. Standard frequency coverage is 2 GHz to 26 GHz, extendable to 110GHz.

### HP 8511A Frequency Converter

When used with the HP 8511A Frequency Converter, the HP 8510B network analyzer provides high-performance measurements from 45 MHz to 26.5 GHz. The HP 8511A contains four separate RF-to-IF converters, all of which can operate over the entire dynamic range of the system.

HP 8511A Options H40 and H41 both extend the frequency coverage to 40GHz. HP 8511A Option H40 is best suited for indoor far field antenna measurements. HP 8511A Option H41 also includes an

internal, switched doubler to provide a 0.045 to 40 GHz test signal using a 20 GHz synthesized source. The HP 8511A Option H41 frequency converter must be located close to the synthesizer and is therefore best utilized in RCS measurement configurations.

### HP 85360A Antenna Measurement Software

The HP 85360A Antenna Measurement Software automates the HP 8510B for acquisition, presentation, and storage of far field antenna radiation patterns. One day of on-site customer consulting is provided with the software.

#### Feature Summary

Acquisition modes	Data presentation	Data analysis
Single axis	Real time plot	Peak gain
Dual axis	Rectangular	Half power
CW frequency	Log magnitude	Beam width
Multiple CW frequency	Phase	Target
Swept frequency	Polar	Beamwidth
Dual parameter	Log magnitude	Trace math
Batch mode	3-Dimensional	Interactive markers
Gain horn calibration	Contour	Delta markers
	Waterfall	

### HP 85320A Test Mixer Module

### HP 85320B Reference Mixer Module

The HP 85320A/B mixer modules are part of the HP 85310A Distributed Frequency Converter, and they provide high-performance, weatherproof downconverters for use in antenna and RCS measurement systems. The HP 85320A is configured as a mixer module for the antenna under test with a built-in LO/IF diplexer to facilitate the use of a single channel rotary joint and to simplify cabling requirements. The HP 85320B is configured as a mixer module for a reference antenna, and it uses an integral leveling detector for LO source power leveling. Both modules are EMI shielded for additional isolation.

### HP 85380A Weatherproof Enclosure

The HP 85380A weatherproof enclosure is designed to protect the HP 85309A LO/IF distribution unit from inclement weather. The enclosure can accommodate up to two LO/IF distribution units. Included with the enclosure are interconnect cables for one LO/IF distribution unit, mounting base plate, and one twist-lock ac power cord connector.

### HP 85381A/B/C Microwave Cable

The HP 85381-series microwave cables should be used for the connections between the HP 8510B, LO source, HP 85310A, and HP 85320A/B mixer modules. Refer to the HP 85300A-series configuration guide for detailed information.

### Ordering Information

	Price
HP 85301A Antenna Measurement System	Contact HP
HP 85310A Distributed Frequency Converter	\$31,500
Opt H01 Additional test channel. Consists of an HP 85309A Option H01 LO/IF distribution unit and one additional HP 85320A test mixer module.	+\$10,450
Opt 908 Adds rack mount kit (product # 5062-3977) see pg 732	+\$32 ☎
Opt 913 Adds rack mount kit with handles (product # 5062-4071)	+\$35 ☎
HP 85360A Antenna Measurement Software	\$19,500
Opt 001 Adds Series 300 Model 340 Controller, HP 98785A 16-inch color monitor, HP 46060A HP-HIL mouse, HP 9153C 20 Mbyte hard disk. Factory software installation included.	+\$11,845
Opt 002 Adds Series 300 Model 360 Controller, HP 98752A 19-inch color monitor, HP 46060A HP-HIL mouse, HP 7957B 81 Mbyte fixed disk drive. Factory software installation included.	+\$23,180

For ordering information on accessory products, refer to the HP 85301A System Configuration Guide.

☎ For same-day shipment, call HP DIRECT at 800-538-8787

# NETWORK ANALYZERS

## Pulsed-RF Network Analyzer

HP 85108A

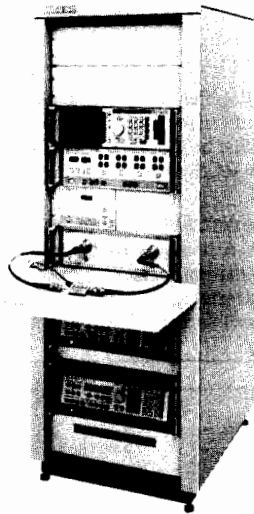

### Magnitude and Phase Characterization

The HP 8510B has become a standard measurement tool for the microwave design engineer. It provides a highly accurate, easy-to-use way to completely characterize the S-parameters of microwave components. This same tool now makes the characterization of pulsed-RF devices as simple as the press of a button. This dynamic characterization allows you to evaluate the magnitude and phase response inside the pulse as a function of time.

### The HP 85108A Pulsed-RF Network Analyzer System

The HP 85108A is a factory-integrated system that provides the entire instrument configuration required to make pulsed-RF measurements. Simply add the desired measurement accessories for a complete system.

The system is built around the HP 8510B with the pulsed-RF measurement capability option (option 008) already installed. The system also includes the HP 85110A S-parameter test set. An HP 83622A and an HP 83624A synthesized sweeper provide, respectively, the RF and LO signals needed to operate the fundamentally mixed test set.

The system also includes on-site installation, and a one-year on-site warranty insures that the system remains up and running.

### The HP 8510B Option 008

The HP 8510B pulsed-RF measurement capability option (Option 008) consists of an additional receiver subsystem for the HP 8510. This pulsed-RF measurement capability, which exists in parallel with the standard HP 8510B operation, provides you with the ability to measure and display the relative magnitude and phase shift of the component as a function of time with an equivalent bandwidth of 2.5 MHz. This allows the evaluation of the dynamic pulsed-RF characteristics for pulse widths down to 1 microsecond. Using the repetitive sampling method, point-to-point display resolution of 100 nanoseconds is available.

This is an actual display of the dynamic pulsed-RF response of a 3 GHz amplifier (10 microsecond pulse width) measured using the HP 85108A system.

Complete microwave error-correction capabilities are available to remove systematic errors that can dominate the measurement.

Markers make evaluating specific time points simple and fast.

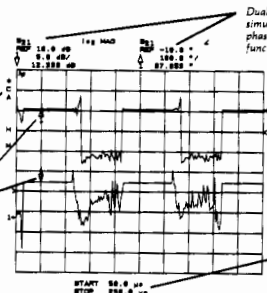

Dual Channel display provides simultaneous magnitude and phase measurement, viewed as a function of time.

View any part of the pulse by simply changing the start or stop times.

### The HP 85110A S-Parameter Test Set

The HP 85110A S-parameter test set is a required system component for the HP 8510B pulsed-RF measurement capability. The figure below shows a simplified block diagram of this test set.

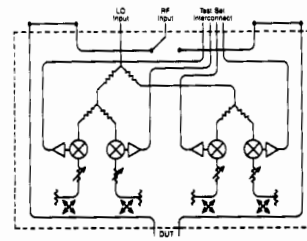

Key to the performance of the test set are the fundamental mixers used to provide the low noise IF necessary to make accurate, pulsed-RF measurements with the pulsed-RF receiver subsystem. Two external synthesizers act as the RF and LO sources for the four-channel downconverter. This approach eliminates the need to dedicate one channel for phase-lock, making full two-port, pulsed-RF S-parameter measurements available. Also, the internal pulse modulator of the RF synthesizer can be used to pulse the device-under-test.

The block diagram also provides some distinct advantages, whether using the HP 8510B for pulsed-RF or standard S-parameter measurements. Because of the coupler-based measurement path and attenuators, the test set can handle high powers, up to 20W. And the connections available on the rear panel provide access to the measurement path, making it easy to configure test systems that use a single measurement connection.

### Ordering Information

#### HP 85108A Pulsed-RF Network Analyzer System

The HP 85108A Pulsed-RF Network Analyzer system is a factory-integrated system that includes the instruments required to make dynamic pulsed-RF measurements. Installation and one-year, on-site warranty included.

This system consists of: HP 8510B Network Analyzer with Option 008 Pulsed-RF Measurement Capability

HP 83622A Synthesized Sweeper with Options: 001 Add Step Attenuator, 003 Delete Front Panel Keyboard/Display, 004 Rear Panel RF Output and 008 1 Hz Frequency Resolution.

HP 83624A Synthesized Sweeper with Options: 001 Add Step Attenuator, 003 Delete Front Panel Keyboard/Display, 004 Rear Panel RF Output and 008 1 Hz Frequency Resolution.

HP 85110A S-Parameter Test Set System Rack

#### HP 85110A S-Parameter Test Set

Requires one HP 83622A 2 to 20 GHz Synthesized Sweeper and one HP 83624A 2 to 20 GHz (high power) synthesized sweeper for system operation.

The HP 85110A is a 2 to 20 GHz S-Parameter Test Set that provides the low noise IF required by the HP 8510B Option 008 Pulsed-RF Measurement Capability.

#### To upgrade an existing HP 8510B System for Pulsed-RF Measurements

If you already own an HP 8510B Network Analyzer with a synthesized sweeper (HP 8340B or 8341B), you can upgrade the system for pulsed-RF measurements. You will need to order the following additional equipment.

#### HP 85110A S-Parameter Test Set

#### HP 83624A Synthesized Sweeper

The HP 83624A Synthesized Sweeper should be used as the system LO source and the HP 8340B or 8341B you already own should be used as the system RF source.

#### HP 85111A Pulsed-RF Measurement Capability Upgrade Kit for the HP 8510B.

The HP 85111A Pulsed-RF Detector Upgrade Kit provides the hardware to upgrade an existing HP 8510B (Rev 4.0 or later) to an HP 8510B with Option 008.

**Price**  
\$185,000

\$55,000

\$55,000

\$39,900

\$12,750



# NETWORK ANALYZERS

## Microwave Integrated Test Systems For MMIC's And Hybrids

257

- Hardware
- Software
- Support

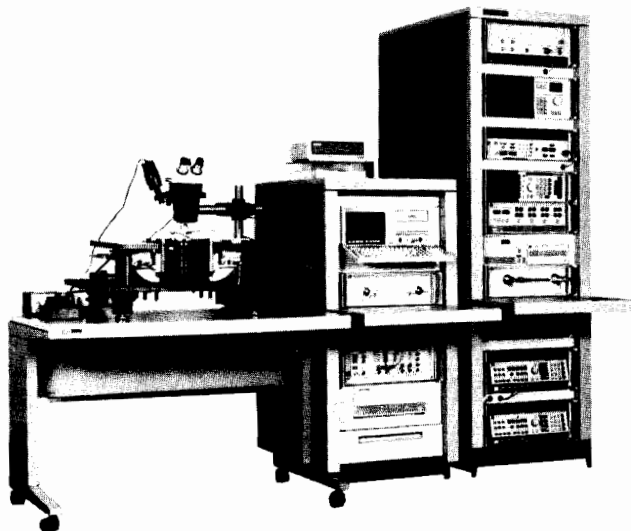

### Complete Test System for MMICs or Hybrids

Let HP supply your next microwave test system, a complete, fully configured system with just the right equipment and CAT software to meet the test needs of your most complex MMIC chips or hybrid circuit assemblies.

Systems can be integrated with a wide range of HP test and measurement equipment to perform a variety of stimulus and response measurements. As an example, consider the following configuration of equipment for testing transmit/receive (T/R) chips or modules for phased array radar applications.

#### Network Analyzer

Gain  
Match  
Isolation  
Magnitude and phase (swept frequency or time domain pulse)  
AM to PM conversion  
Power gain and compression

#### Noise Figure Meter

Noise figure

#### Spectrum Analyzer

Harmonics  
Spurious analysis

#### Power Meter

Power calibrations  
Power measurements

#### Pulse Pattern Generator

Digital stimulus

#### Pulse Generator

Pulse modulation

#### Oscilloscope

Pulse modulation waveforms  
Switching times

#### dc Power Supplies

Functional test  
Parametric test  
dc bias (continuous and pulsed)

With your HP test system, you'll be able to measure the entire range of performance specifications required by MMIC chips or hybrids such as amplifiers, oscillators, mixers, attenuators, switches, or a combination of these - all with a single touchdown of the wafer probes or a single fixture insertion. And, be assured that your HP system will provide the optimum in test performance and accuracy, and will be backed by the best service support in the industry.

### Benefits of Integrated Test Systems

#### Lower your test time

Integrated systems reduce test times by at least a factor of 2 over the same testing with multiple wafer passes or fixture insertions on separate test systems.

#### Increase your test accuracy

Complete test data, taken at the same time under the same DC bias and temperature conditions, provides for the highest accuracies in model extraction and product characterization.

#### Increase your product yield

Reduced handling decreases wafer breakage, and yields increase due to reduced pad or connector damage.

#### Increase your product reliability

Reduced pad damage results in better bonding, and single pass testing decreases the chances of ESD damage.

#### Maximize your system up-time

You get responsive, single vendor support from HP, worldwide.

Added together, these benefits will mean a substantial reduction to your microwave component costs!

#### Use either probe or fixture interfaces

Since each integrated system combines all measurement capability via a single test port set, you can easily interface to your MMIC or hybrid device using industry standard wafer probe or fixture systems.

#### System integration and support

Each test system is fully integrated at HP with hardware and software, then installed at your facility. This frees your resources for more effective product development and manufacturing. Then, once installed, local system support from HP assures that your system continues to perform with maximum up time.

#### Experience counts

Numerous test systems similar to the one shown above have already been supplied to customers around the world to cover a variety of MMIC, T/R module, and TWT testing applications. In producing these integrated systems, HP has combined 50 years of experience in producing the very best in test instrumentation and computation tools with over 15 years of experience designing, fabricating and testing our own world class GaAs devices, MMICs and hybrid assemblies. When you choose HP you get a test system supplier who can understand and relate to your testing needs - first hand!

If the capabilities of a completely integrated approach to component test interest you, please contact your nearest local HP sales representative for more information on how such a system can be configured and delivered to you.

# LOGIC ANALYZERS

## General Information

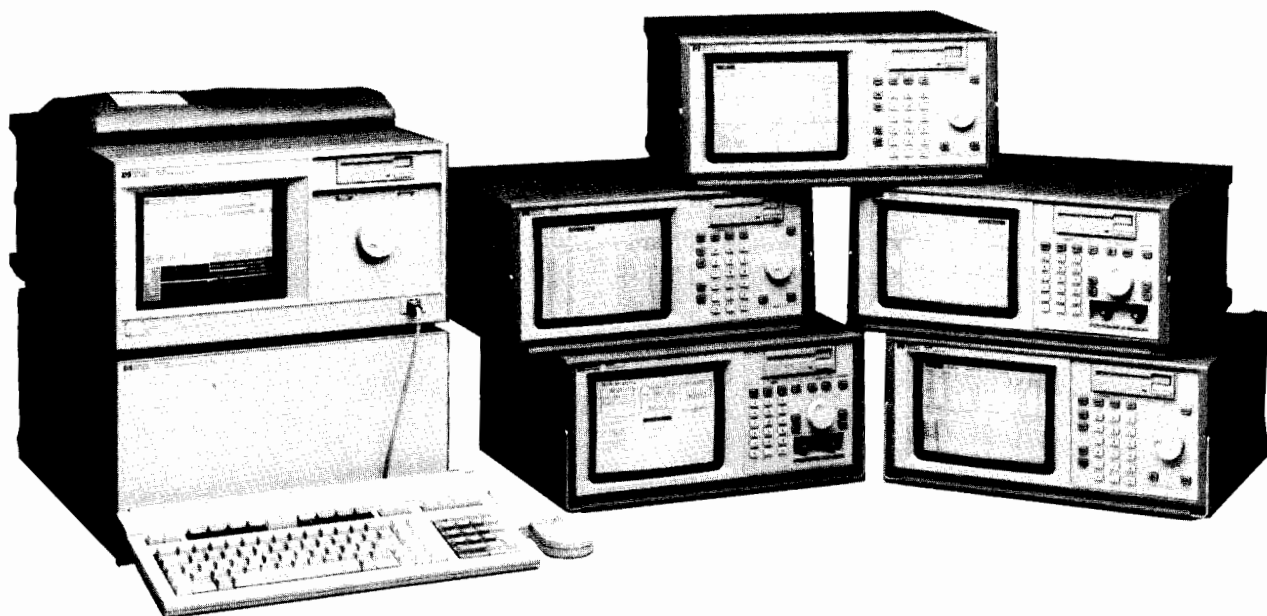

HP Family of Logic Analyzers



### The HP Family of Logic Analyzers

HP offers you a wide selection of logic analyzers tailored to meet your measurement needs. HP logic analyzers support such diverse applications as software and hardware debugging, software performance analysis, hardware characterization, prototype verification, system integration, low-volume manufacturing test, and failure analysis. HP is committed to providing you with the tools you need to design, characterize, and debug digital systems.

#### Value

HP logic analyzers offer value. In addition to the price and performance offered by HP logic analyzers, you can rely on Hewlett-Packard's traditional reliability and quality for low cost-of-ownership.

Option W30 adds to product warranty to provide 3 years of customer return repair service from the time of hardware delivery. When you purchase option W30, Hewlett-Packard provides you with all labor, parts, and materials necessary to maintain your product in good operating condition. In addition, Hewlett-Packard performs preventative maintenance and installs factory-recommended improvements and modifications, when appropriate, at the time of product repair. You can get assistance when and where

you need it with the HP worldwide sales and support organization.

### HP Logic Analyzers offer Unparalleled Ease of Use

Set up measurements quickly using the HP 16500A touch screen. Make analysis of results easier by creating your own label names and channel assignments. To change a parameter, simply point to the field you need to change, then enter the value with a pop-up keypad or knob. Automatically configure the instrument to a predetermined state upon turning on the instrument. Use the HP 16500A's optional keyboard mouse or trackball to operate the instrument from across your workbench. The keyboard supports the full functionality of the touch screen.

### Use Different Measurement Modules to find the Problem

When the symptom can be captured, but the problem is not identified, use the intermodule bus to trigger other measurement modules to help find the problem. For example, you might find a glitch with the timing analyzer, but cannot tell what is causing the problem. Is it noise or ringing? By triggering the oscilloscope with the timing analyzer, you can get a picture of the event and can more quickly identify its cause.

### See Analog Phenomena with a Built-in Scope

Only HP logic analyzers offer digitizing oscilloscopes with the performance you need. Now, you can get full 250 MHz analog bandwidth (1 GSa/s), 8 bit digitizing scope capability in the 16500A mainframe. Or, get a full 100 MHz analog bandwidth (400 MSa/s) oscilloscope with the digitizing advantages of waveform storage and recall, automatic measurements and markers, and powerful logic triggering in the 1650-series logic analyzers. In addition, you get up to 80 channels of full-featured state or timing for much less than the instruments would cost separately.

### Make Measurements Quickly with a Wide Range of HP Microprocessor and Bus Support

Hewlett-Packard offers the broadest support for busses, interfaces, and microprocessors. Support includes inverse assembler software and quick connection probes for most popular processors. If your design includes a proprietary processor, you can create your own inverse assembler, or have Hewlett-Packard design a custom solution. See page 262 for microprocessor support details.

### Full-featured RISC Support

Get full-featured, 100 MHz state analysis with the new HP 16540A and 16541A 100 MHz state analysis modules. HP provides full support for most RISC and CISC processors. Up to 208 channels can be probed simultaneously.

### Unmatched Compatibility

Compatibility protects your investment because you can use any of HP's analyzers to make your measurement. Most preprocessors are compatible with every HP analyzer, as are configuration files and data files.

All HP logic analyzers use the same user interface concepts. If you are familiar with one instrument, you will find the same functions in the same place on other models.

Programmability is the same for all models. You do not need to learn new commands or constructs when changing models. Programs written for the HP 1650B run on the HP 16510B.

Many analyzers can be upgraded to include more powerful measurement features. For example, the HP 1651B 32-channel 25 MHz state/100 MHz timing analyzer can be upgraded to the HP 1653B state/timing analyzer with a 100 MHz bandwidth Oscilloscope. See page 291 for upgrade kit information.

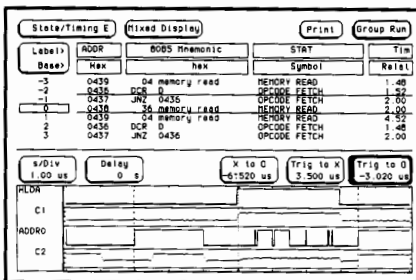

### State, Timing and Oscilloscope Data Time-correlated on the same display.

State and timing data is compatible across all logic analyzer models. You can transfer important information with ease. When you capture data with a portable HP logic analyzer, you can display and analyze it with the HP 16500A logic analysis system. You can also use captured data in the digital pattern generator to reduce functional test development time.

ALL state and timing analyzer data can also be translated and transferred to many popular simulators and testers . . . automatically. The data you capture with your HP logic analyzer can be automatically transferred to popular workstations and analyzed, or it can be transferred to ASIC verification, board, and IC testers.

### A Computer in Each Analyzer

Compact, portable analyzers mean that you have measurement power where you need it. At the heart of each HP analyzer is a powerful 16-bit processor dedicated to quickly making and displaying measurements. You do not need to tie up a personal computer in order to make measurements, and portability is increased.

If you need to put measurement data into your personal computer memory, Hewlett-Packard provides the documentation to make it easy. Ask your HP sales representative for "HP's Logic Analyzer and Personal Computer Programming Series" (HP Pub No. 5952-4241).

### Powerful State Triggering

HP logic analyzers have complex state triggering to filter unnecessary data and provide you with only the data you need for your measurement. Up to five clocks or qualifiers can be used to determine exactly when to sample. Eight full-featured sequence levels, each with storage qualification, branching, and complex pattern triggering, allow you to store only the data you need. Eight pattern recognizers and a range term offer the flexibility to extract data from complex code. Tag time or states to keep track of how and when your code is executed.

### Quickly Store or Recall Setups and Data

Store measurements and configurations to the built-in disk drive(s). Use auto-load to recall a specific configuration when turning on the instrument. Use the disk to store information captured from a remote location, then examine the error in more detail on another HP logic analyzer in the lab.

### HP-IB and RS-232: Standard on Every Analyzer

Both HP-IB and RS-232 ports are standard on each instrument. You can program any analyzer from either interface, while using the other interface to control a printer. Upload measurement data to your computer quickly for additional analysis.

### Complete Package

The price of each HP logic analyzer includes all you need to start making measurements, including general-purpose probing, grabbers, and software. Your preprocessor also includes everything you need to make measurements on your processor, including probing and inverse assembly software.

### Instant Documentation

With the push of a button, you can document results professionally with the standard hardcopy feature. Full-color printouts are

available using the HP PaintJet printer with the HP 16500A. Documentation helps you trace your steps and communicate findings to others. Either the HP-IB or RS-232 port can be assigned to control a printer. The HP 16500A supports HP DeskJet, LaserJet, PaintJet, ThinkJet, QuietJet, and Epson printers (such as the RX-80, RX-100, MX-80 and the MX-100).

### Links to Simulation, Manufacturing Test

Transfer and translate simulation vectors to the HP 16500A pattern generator and state analyzer to perform functional prototype analysis. Or, capture data from known good boards and transfer that information to board testers, or transfer the information back to the simulator.

### Lightweight, Flexible Probes

Lightweight, flexible passive probes make connection to the target system easier than ever. There are no heavy active pods to dislodge the probing scheme at the wrong time. Cooling is not a problem because the passive probes do not generate heat.

Loading at the point of contact with your circuit is 100 K $\Omega$  shunted by 8 pF capacitance. Passive probing provides excellent impedance over a wide frequency range. And the low capacitance loading means that critical edges are not affected by probing. Hewlett-Packard's complete general-purpose probing solution comes standard with each analyzer. See page 280 for information on connectors that make it easy to interface to your design.

### Identify Performance Bottlenecks

The HP 10390A system performance analysis software adds three measurements to HP state analyzers. The state histogram and state overview measurements display the intensity of activity in specific areas of memory or identify modules that are prime targets for optimization. The time interval measures execution time of a module, time between calls to a module, or time between two different modules.

### Logic Analyzer Section Highlights

Selection Guide	260
Measurement Examples	261
Microprocessor/Bus Support	262
HP 1650B, HP 1651B	266
HP 1652B, HP 1653B	268
HP 16500A & Modules	270
Accessories	280
Specifications	282
Upgrade Kits	291
Ordering Information	293

# LOGIC ANALYZERS

## Selection Guide

HP's selection of logic analyzers consists of the HP 1650 series of portable logic analyzers and the HP 16500A logic analysis system. The following application reference guide provides a quick overview of HP analyzers, key measurement needs, and features. More information on logic analyzers is provided on the following pages.

### Application Reference Guide

	1650B	1651B	1652B	1653B	1654B	16500A
<b>Microprocessor support</b>						
8 bit	Y	Y	Y	Y	Y	Y
16 bit	Y		Y		Y	Y
32 bit	Y		Y			Y
RISC						Y
DSP	Y	Y	Y	Y	Y	Y
Multiple $\mu$ P support	Y		Y		Y	up to 10
Bus	Y	Y	Y	Y	Y	Y
Custom	Y	Y	Y	Y	Y	Y
<b>Hardware analysis</b>						
<b>Timing:</b>						
100 MHz/all channels	Y	Y	Y	Y	Y	Y
1 GHz						Y
Glitch detection	5ns	5ns	5ns	5ns	5ns	2ns
Maximum channels	80	32	80	32	64	400@100 80@1GHz
Digitizing oscilloscope						Y
400 MSa/s/100 MHz BW			Y	Y		Y
50 MBit/s pattern generation						Y
<b>Cross-domain measurements</b>						
Timing/state	Y	Y			Y	
Timing/state/scope			Y	Y		Y
<b>Software analysis</b>						
State speed (MHz):	35	25	35	25	35	35/100
Channel count:	80	32	80	32	64	400/208
Sequencer speed (MHz):	35	25	35	25	35	35/100
Correlated state listings	Y	Y	Y	Y	Y	Y (100MHz)
System performance analysis	Y	Y	Y	Y	Y	Y
Compare/run until	Y	Y	Y	Y	Y	Y
Chart mode	Y	Y	Y	Y	Y	Y
<b>System features</b>						
Portable	Y	Y	Y	Y	Y	
Modular						Y
Programmability			HP-IB/RS-232 on all			
Hard-copy output			Variety of HP-IB or RS-232 printers			
Setup storage/auto load	Y	Y	Y	Y	Y	Y
Data storage			compatible disk files			
Color						Y
Keyboard/mouse						Y
Page reference	266	266	268	268	270	270

### Logic Analysis Systems

HP 16500A	HP 16510B	HP 16515/516A	HP 16530/531A
5-slot mainframe	80 channels/card	1 GHz timing analysis	Oscilloscope time base and acquisition
9-inch color display	Up to 5 cards/16500A	16 channels/card	Up to 8 input channels per 16500A
Touch screen or mouse control	100 MHz sampling for timing analysis	Up to 80 channels with full capability/16500	Can be triggered by state or timing analysis
2 3.5-inch disk drives	35MHz maximum input clock in state analysis	1 ns resolution	400 Msamples/s for 100 MHz bandwidth for single-shot and repetitive signal analysis
Inter-card triggering via intermodule bus	Detects glitches as small as 5 ns	8 kbit/channel memory	Automatic measurements and statistics
Screen hard copy via RS-232 + HP-IB	Simultaneous state/timing analysis		
Programmability via RS-232 + HP IB		<b>HP 16520/521A</b>	
Simultaneous display of state, timing, and oscilloscope traces		50 Mbit/s pattern generator	
Links to CAE and manufacturing testers	<b>HP 16511B</b>	Up to 204 channels/16500A	
	Combines two HP 16510B systems	ECL and TTL output	
	Triggers up to 160 channels wide	Can be combined with 16510B or 16515/516A for stimulus/response testing	

### Measurement Examples

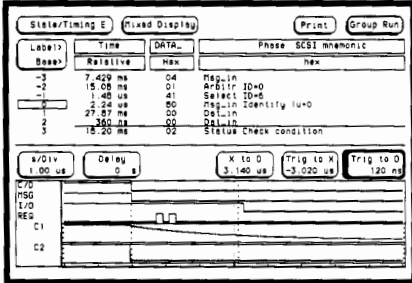

Using the HP 16500A, you can display state listing, timing diagrams and oscilloscope waveforms on the same menu. In this case, data captured from a SCSI device is displayed.

### Key Product Features

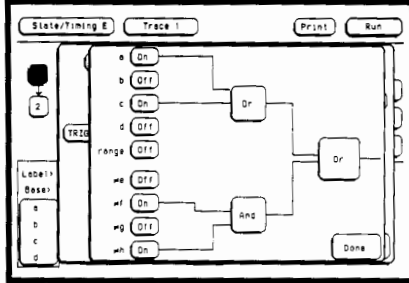

Powerful state triggering lets you locate the problem quickly. Here, resource terms are combined to create a complex trigger words. Pop-up menus make it easy to move around the analyzer.

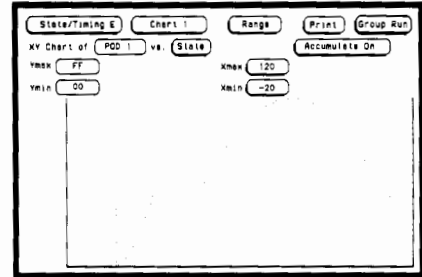
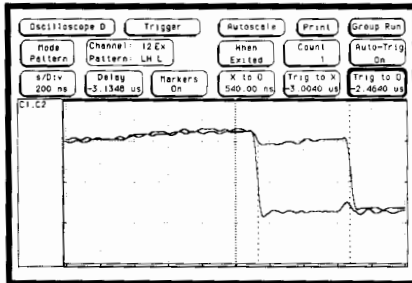
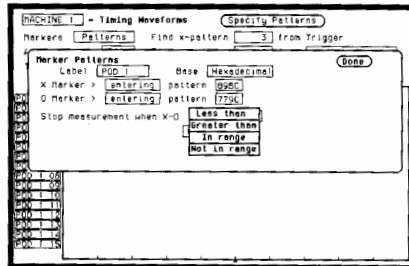

Chart mode lets you display digital data on an X-Y chart. Here, digital data captured from an analog-to-digital converter is displayed, allowing you to quickly find a discontinuity.



S51 The HP 1652B/1653B and the HP 16530A/16531A are full-featured oscilloscopes embedded into logic analyzers. In addition to time-correlated measurements with the timing and state analyzers, you can use the oscilloscopes for precision time interval and voltage measurements.



Postprocessing lets you set up measurements to detect timing violations. In this case, when the time between patterns violates a user-specified time, the analyzer stops acquiring data and displays the results.

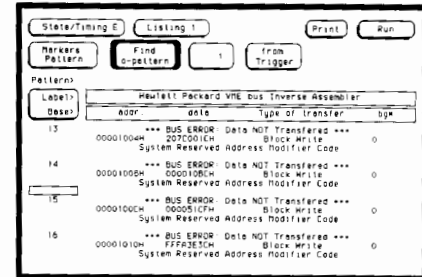

Hewlett-Packard offers the broadest micro-processor support. Here, an HP 16500A logic analysis system with an HP 16510B module is decoding VME bus instructions. See page 262 for bus and preprocessor information.

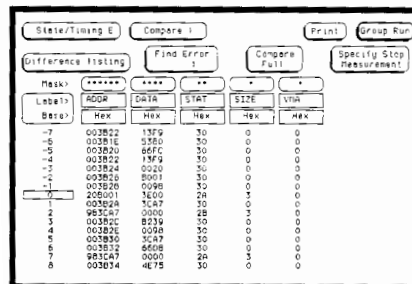

Use State Compare mode to compare known good circuit behavior with captured data. Compare Mode allows you to mask selected channels and data.

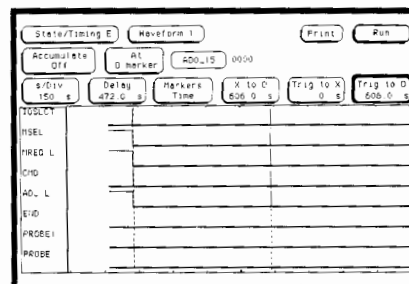

Use transitional timing to capture data over long periods of time. In this example, data is captured over a 150 second interval.

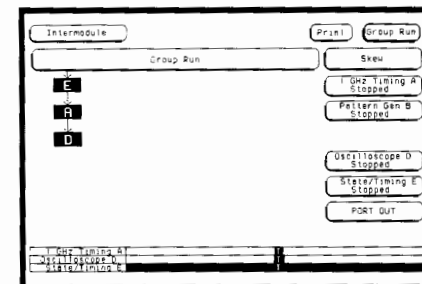

Use the HP 16500A's Intermodule Bus (IMB) to make complex cross-domain measurements. Here a state trigger is used to trigger 1GHz timing and the 400 MSa/s oscilloscope.

# LOGIC ANALYZERS

## Microprocessor and Bus Support

### Simplified Data Interpretation and Interconnections

Hewlett-Packard offers broad support for microprocessors, microcontrollers, interfaces, busses, and digital signal processors. Support includes inverse assemblers, which display target system activity in easy-to-understand mnemonics, and single-probe connection schemes for most processors.

If your design includes a custom processor, or ASIC, you can use the user-definable inverse assembler and microprocessor interface kit to develop your own support package.

Additional software tools enable you to identify software bottlenecks in your system. The system performance analysis package (SPA) can help you find out where your system is spending its time.

### HP Support for the Newest Processors

Hewlett-Packard has the resources and commitment to support the newest microprocessors. Hewlett-Packard works with semiconductor vendors to ensure that, as processors become available for development, you can use your HP logic analyzer to integrate them into your new system. If your processor is not listed in the table below, contact your HP sales representative to determine its support status.

### Additional Microprocessor Support through Third Parties

Hewlett-Packard has teamed up with a number of third-party hardware and software vendors to provide complete solutions to your microprocessor and bus analysis needs. Contact your HP field engineer for details on support for the following, as well as various other package types for popular microprocessors.

- EISA bus
- MCA bus
- PC XT/AT bus
- MIL STD 1750 processor
- MIPS R3000
- FDDI
- National DP 8344 BCP

### How to Calculate your System's Bus Rate

The logic analyzer state speed required to capture data from a microprocessor system depends on its bus rate. Bus rate is a function of microprocessor clock speed, which varies for different microprocessors. Complex instruction set computers (CISC) typically require two-to-four clock cycles per bus cycle. Many reduced instruction set computers (RISC) require one clock cycle per bus cycle. Data showing the minimum clock cycles per bus cycle is shown for each HP-supported processor listed in the tables below.

### Selection Guide\*

Microprocessor (Package Type)	Logic Analyzers Supported				Items Included			Number of Pods Used	Fastest Clock Rate Supported	Minimum Clock Cycles/Bus Cycle	10269C Required	Ordering Number	Price
	1650/52 16510	1651/53	1654	16511	Hardware Interface	Inverse Assembler	Termination Adapters						
<b>Advanced Micro Devices (AMD)</b>													
Am29000 (PGA)	•				•	•	5	5, 8 or 9	50 MHz INCLK	2	No	E2417A	\$1600.
<b>Analog Devices</b>													
ADSP2100/2101	•		•			•	0	3	All	N/A	No	[5] [8]	\$995
<b>GTE</b>													
65816 [5]	•		•			•	0	3	All	N/A	No	[5] [6]	Factory supplied
<b>Hitachi</b>													
64180 (DIP)	•		•		•	•	3	3	All	N/A	No	10336G	\$700.
64180 (PLCC)	•		•		•	•	3	3	All	N/A	No	10336H	\$1300.
6301/6303 (DIP)	•	•	•		•	•	2	2	All	N/A	No	10335G	\$700.
<b>Intel</b>													
MCS-51 (DIP) [1]	•	•	•		•	•	0	2	16 MHz CLKIN	12	Yes	E2415A	\$1400.
MCS-96 (PLCC/PGA) [2]	•		•		•	•	0	3	12 MHz	2	Yes	E2416A	\$1350 (PLCC) \$650 (PGA)
8080	•	•	•		•	•	0	2	All	N/A	No	[5] [6]	Factory supplied
8085 (DIP)	•	•	•		•	•	0	2	12 MHz CLKIN	3	Yes	10304B	\$1000.
8086/8088 (DIP)	•		•		•	•	0	3	10 MHz CLK IN	4	Yes	10305B	\$1400.
80186 (PGA)	•		•		•	•	4	3	25 MHz CLK IN	4	No	10306G	\$700.
80286 (PGA/LCC/PLCC)	•		•		•	•	0	3	32 MHz CLK IN	4	Yes	E2409A	\$1400.
80386 (PGA)	•		•		•	•	0	5	66 MHz CLK2	4	Yes	10314D	\$2200.
80486 (PGA) [12]	•		•		•	•	7	5 or 7	35 MHz	1	No	E2403A	\$1400.
80860	•		•		•	•	8	5 or 8	35 MHz	2	No	E2405A	\$1500.
80960CA	•		•		•	•	5	5 or 8	35 MHz	1	No	[3]	Factory Supplied

\*See page 264 for footnotes

### Quick, Reliable, Complete Connections with Target Systems and HP's Logic Analyzers

HP microprocessor support offers you a quick, reliable connection to your target system. HP preprocessors are the mechanical and electrical connection between your target system and HP logic analyzers. They provide reliable, correct, fast and convenient connections to your system. HP preprocessors are engineered to provide low capacitance probing, so your target system will not be disturbed. HP provides all clocking and demultiplexing circuits to correctly capture

your system operation. Additional status lines are provided to further decode the operation of your processor.

### Microprocessor Support: the Window to System Behavior

Analyze the code in your microprocessor-based system while operating at full clock speed. HP microprocessor support allows you to follow the path of your software without intrusion, from power-up through interrupts to fatal system crashes.

Inverse assembly software translates logic levels captured by the logic analyzer into

microprocessor mnemonics that you are already familiar with. The resulting display can easily be compared to original assembly language listings to track down software defects.

Most preprocessors include an inverse assembler disk. When loaded into the logic analyzer from the internal disk drive, this software configures the instrument for use with your microprocessor and transforms acquired address, data, and status of each state into microprocessor mnemonics.

Microprocessor (Package Type)	Logic Analyzers Supported				Items Included			Number of Pods Used	Fastest Clock Rate Supported	Minimum Clock Cycles/Bus Cycle	10269C Required	Ordering Number	Price
	1650/52 16510	1651/53	1654	16511	Hardware Interface	Inverse Assembler	Termination Adapters						
<b>Motorola</b>													
146805E2 [5]	•		•			•	0	2 (3 for Port A/Port B signals)	All	N/A	No	[5] [6] [9]	Factory Supplied
56000 [5]	•		•			•	0	3	All	N/A	No	[5] [9]	Factory Supplied
6803 [5]	•	•	•			•	0	2	All	N/A	No	[5] [6] [9]	Factory Supplied
68000/68010 (DIP)	•		•		•	•	0	3	12.5 MHz CLK	4	Yes	10311B	\$1600.
68000/68010 (PGA)	•		•		•	•	3	3	16 MHz CLK	4	No	10311G	\$600.
68020 (PGA)	•				•	•	5	5	33 MHz CLK	3	No	E2426A	\$2000.
68030 (PGA)	•				•	•	5	5	50 MHz CLK	1	No	E2406A [11]	\$2000.
68040 (PGA)	•			•	•	•	0	5 or 7	35 MHz	1	No	E2420A	\$2000
68HC11 (DIP)	•	•	•		•	•	4	2	8.4 MHz CLK	2	No	10315G	\$750.
68HC11 (PLCC)	•	•	•		•	•	4	2	8.4 MHz CLK	2	No	10315H	\$1800.
68302	•		•		•	•	0	3	All	N/A	No	E2414A	\$400.
68332	•		•		•	•	5	4	All	N/A	No	E2413A	\$750.
88100 (PGA)	•			•	•	•	10	5 or 10	35 MHz CLK	1	No	E2404A	\$1700.
88200 (PGA)	•			•	•	•	5	5	35 MHz CLK	1	No	E2400A	\$1200.
<b>National Semiconductor</b>													
NS 32016 [5]	•		•			•	0	3	All	N/A	No	[5]	Factory Supplied
HPC 16003/43/83, 46003/43/83	•		•			•	0	3	All	N/A	No	[5] [13]	Factory Supplied
<b>NEC</b>													
7810/11	•		•			•	0	3	All	N/A	No	[5]	Factory Supplied
V20/V30 (DIP)	•		•		•	•	0	3	All	4	Yes	10337B	\$1790.
V40/V50 (DIP)	•		•		•	•	0	3	All	4	Yes	10338B	\$2675

Table continues on next page

# LOGIC ANALYZERS

## Microprocessor and Bus Support (cont'd)

### Backplane and Bus Interfaces

Backplane and interface standards are becoming more common. They minimize hardware design efforts while increasing the complexity of systems that designers can assemble. This has created a need for better system integration tools. Hewlett-Packard has led the way in providing tools for bus and interface analysis with support for standards such as MIL-STD-1553A/B, SCSI, VME, and RS-232C.

### Interactions Between Modules and the CPU

Your new peripheral board won't work with the computer. Is it a hardware or software problem? Use HP bus preprocessors to examine code flow and find the symptoms of the problem. Then use timing analysis to determine whether your system meets timing specifications.

**Examine and Correlate Analog Behavior with a Built-in Scope** Capture single shot analog events with the 400 MS/s digitizing oscilloscope. The bus analyzer can be used to trigger the oscilloscope so that you can capture pre- or post-trigger data.

### Monitor Bus Hardware and Information Flow

The HP 10342B bus preprocessor provides analysis capabilities for three popular interface buses: HP-IB (Hewlett-Packard's implementation of IEEE-488), RS-449, or RS-232C/CCITT v.24. This package gives you software that sets up the analyzer for the measurement at hand, a complete view of asserted control lines, and conversion of the captured data into easy-to-understand mnemonics.

### Mil-standard 1553A/B Bus Analysis

The HP 10341B bus monitor provides complete mechanical and electrical connection between your MIL-STD-1553A/B bus system and your HP logic analyzer. The preprocessor acts as a monitor and does not take up an address slot on the bus. You can trigger on specific types of bus error, such as parity or Manchester error, then use the logic analyzer's built-in scope to view pre-trigger bus activity.

### Small Computer Systems Interface (SCSI) Analysis

Capture and analyze command sets and data activity for most 8-bit SCSI devices as specified in SCSI standard X3t9.2/86-109 Revision 2. The preprocessor allows you to use the logic timing analyzer to check for timing violations. You can also use the built-in oscilloscope to examine control or data lines in detail. To use an HP logic analyzer monitor both the CPU and the SCSI bus at the same time to correlate data transfer accuracy. One state analyzer monitors the SCSI bus while the other captures microprocessor data flow. All data can be displayed in time-correlated interleaved state listings.

### VME Bus Analysis

Capture activity on your A or B size VME backplane with the HP 10344A/B preprocessor. The preprocessor acts as an extender card in your system and lets you monitor bus activity between modules without interruptions. All VME bus operations are displayed. Data rates of greater than 50 Mbyte/s can be monitored.

Microprocessor (Package Type)	Logic Analyzers Supported				Items Included			Number of Pods Used	Fastest Clock Rate Supported	Minimum Clock Cycles/Bus Cycle	10269C Required	Ordering Number	Price
	1650/82 16510	1651/83	1654	16511	Hardware Interface	Inverse Assembler	Termination Adapters						
<b>NEC (cont.)</b>													
V60 (PGA)	•		•		•	•	4	4	All	N/A	No	103396	\$1215
V70 (PGA)	•				•	•	5	5	All	N/A	No	E2407A	\$1315
<b>Rockwell International</b>													
6502 [5]	•	•	•			•	0	2	All	N/A	No	[5] [6]	Factory Supplied
<b>Texas Instruments</b>													
34010	•	•	•			•	0	2	All	N/A	No	[5]	Factory Supplied
320C10/14	•	•	•			•	0	2	All	N/A	No	[5]	Factory Supplied
TMS 32020/320C25	•		•		•	•	3	3	40 MHz CLKX/R [25] 20 MHz CLKX/R [20]	4	No	E2418A	\$700.
TMS 370C050	•	•	•			•	0	2	20 MHz	10	No	[3]	Factory Supplied
<b>Zilog</b>													
Z80	•	•	•		•	•	0	2	All	N/A	Yes	10300B	\$1000.
Z8001 [5]	•		•			•	0	3	All	N/A	No	[5] [6]	Factory Supplied
Z8002 [5]	•		•			•	0	3	All	N/A	No	[5] [6]	Factory Supplied
<b>Bus and Interface Preprocessors</b>													
HP-IB, RS-232 and RS-449 [7]	•	•	•		•	•	0	2	19.2 kbits/s RS232/RS449 All—HP-IB	N/A	Yes	10342B [7]	\$1400.
HP-IB	•	•	•		•	•	2	2	All	N/A	No	10342G	\$400.
SCSI	•	•	•		•	•	0	2	10 MHz	N/A	Yes	10343B	\$1500.
MIL-STD 1553A/B	•	•	•		•	•	0	2	1 MHz	N/A	Yes	10341B	\$4500.
VMEBus (A-size)	•				•	•	0	5	16.67 MHz	N/A	No	10344A	\$1000.
VME/VXIBus (B/C-size)	•				•	•	0	0			No	E1323A	\$1200.

#### Footnotes:

- [1] Includes 8031/8032/8051/8052, 8751 and CMOS versions.
- [2] Includes 8096/7-90, -AH, -BH, 80C196KA, -KB.
- [3] These products are available from the factory. Contact your Field Engineer to order.
- [4] Requires 10320C also.
- [5] Available as Inverse Assembler with Operating Note only. No interfacing hardware provided.
- [6] 10320C and 10322C recommended but not required. If you buy a 10320C you will also need a 10269C.
- [7] Supplied with (1) RS232C/V.24 ribbon cable 0.75 m (2.5 ft), (1) RS449 ribbon cable 0.75 m (2.5 ft), (1) HP-IB ribbon cable 0.75 m (2.5 ft). Supports both balanced and unbalanced (RS422A and RS423A) implementations of RS449.
- [8] These products are available from an HP Project Center. Contact your HP Field Engineer to order.
- [9] Hardware Interface for GP probing available from Emulation Technology.
- [10] These products have been designed to work with a Motorola development board only.
- [11] Replaces HP 10316G.
- [12] Configurations for HP 16515A/16516A supplied also.
- [13] This product has been designed to work with the National Semiconductor DB2 Development Board.
- [14] Not Specified.





An HP Vectra PC or IBM PC-compatible is all you need to develop your own custom inverse assembler.

### Designing Your Own Preprocessor . . . the HP 10320C

The HP 10320C user-definable interface allows you to build a custom preprocessor. Use the HP 10320C when you need any of the following:

- an interface for analyzing custom or proprietary devices with your logic analyzer
- a semi-custom test fixture for using your logic analyzer in a manufacturing test environment
- a link for ribbon cables or connections to your logic analyzer

The HP 10320C provides a breadboard that fits inside the HP 10269C general purpose probe interface. In addition, the kit includes mechanical hardware to mount the breadboard in place and connectors for sending your signals to the HP 10269C. The accompanying manual discusses the interface design process, including what to look for in your target system, how to design so that set up and hold requirements are met, and tips on power supply distribution.

### Building and Connecting the Interface . . .

Companion accessories enhance the utility of the HP 10320C. The HP 10321A microprocessor interface kit provides many of the parts needed when designing an interface that uses ICs and other active devices. It includes sockets, bypass capacitors and a fuse for power distribution, and wire-wrap headers to simplify the wiring of your interface. With the HP 10321A, you only need to provide the specific components and active parts used in the interface design.

The HP 10322A, HP 10323A, and HP 10324A cables provide a reliable mechanical and electrical connection between a socket on your target system and the HP 10320C user-definable interface. Each cable has a special socket assembly for easy connection without damaging the pins of your device. Remove your IC from your system, plug the cable in its place, then plug your chip into the zero-insertion-force

socket on the cable. This technique minimizes the capacitive loading to your system and gives you a low-profile, reliable hook-up.

For 40-pin DIP packages, order the HP 10322A; 48-pin devices require the HP 10323A. 64-pin DIP ICs require the HP 10324A.

### Display Mnemonics Match Your Custom Interface

Just as the HP 10320C user-definable interface allows you to design custom hardware, the HP 10391B inverse assembler development package allows you to design a custom inverse assembler for your logic analyzers. This software package allows you to write an inverse assembler that will display your system operation in familiar mnemonics across up to 160 channels.

The HP 10391B is a macro assembler that runs on HP Vectra personal computers or IBM-PC compatibles. The HP 10391B includes Pascal-like instructions such as CASE and IF-THEN statements, strong bit-manipulation capabilities for extraction of single bits, or conditional branching on a few bits within a word, and assembly-language constructs including AND, ROTATE, and INCREMENT / DECREMENT instructions.

### Required Equipment

The HP 10391B requires the following equipment:

- 1) HP Vectra PC, IBM-PC\* or PC compatible with a minimum of 256K of memory and MS-DOS\*\*2.1 or above.
- 2) 1 floppy disk drive with an internal hard disk (recommended configuration) for the PC, or two floppy disk drives.
- 3) RS-232C port and cable. Recommended card: HP 24540A Serial/Parallel Card or HP 24541A Dual Serial card. For 25-pin ports, use cable HP 13242G or equivalent. For 9-pin ports, use HP 24542G cable.
- 4) HP 1650A/B, 1651A/B, 1652B, 1653B Logic Analyzer, or HP 16500A Logic Analysis System with an HP 16510B/16511B State/Timing card installed.

\*IBM-PC is a trademark of International Business Machines

\*\*MS-DOS is a U.S. registered trademark of MicroSoft Corporation

# LOGIC ANALYZERS

## Portable Logic Analyzers

HP 1650B, 1651B, 1654B

- HP 1650B: 80 channels of 35 MHz state/100 MHz timing
- HP 1654B: 64 channels of 35 MHz state/100 MHz timing
- HP 1651B: 32 channels of 25 MHz state/100 MHz timing
- Broad support for microprocessors, busses and interfaces
- Simultaneous state/state or state/timing measurements

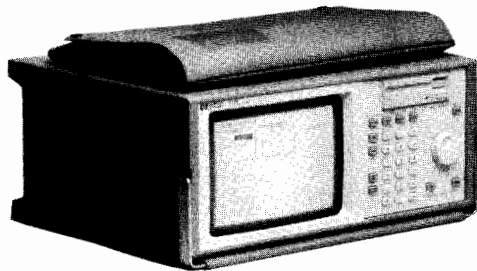

HP 1650B

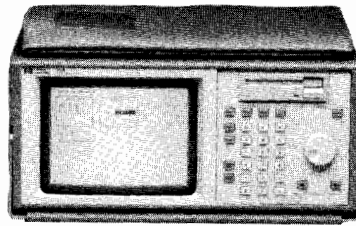

HP 1651B

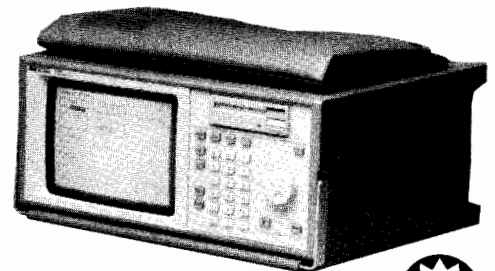

HP 1654B



### HP 1650B, HP 1651B, HP 1654B: Best Value in General-Purpose Logic Analyzers

For microprocessor analysis or general purpose state and timing debug, the HP 1650B, HP 1651B and HP 1654B logic analyzers offer the best value. Each analyzer can be configured as a one- or two-state analyzer, a state analyzer/timing analyzer, or a timing analyzer. Data captured by either analyzer can be displayed with full time correlation. Lightweight, flexible, passive probing is included.

### Support for Most Microprocessors, Busses and Interfaces

The HP 1650B, 1651B and 1654B support a broad range of microprocessors, busses, and interfaces. Each support package turns your analyzer into a powerful debugging tool dedicated to the task at hand. Most support packages include a 3 1/2" disk that configures the analyzer and translates captured data into mnemonics. See pages 262-264 for details on support for your system.

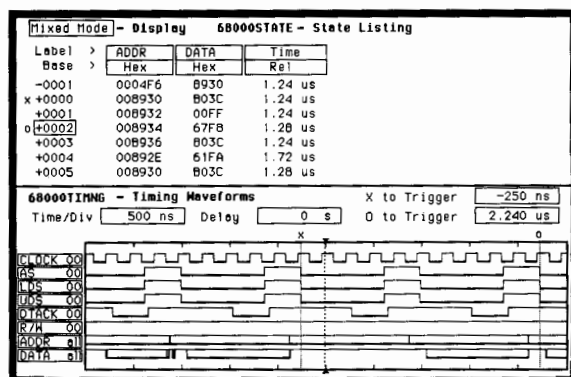

Time Correlated State and Timing Displayed on the Same Screen

### Powerful State Analysis Helps You Focus on Needed Information

The HP 1650-Series B powerful state triggering filters out unnecessary data and provides a listing of the crucial data:

- Clocks and clock qualifiers allow your system to determine when the analyzer takes a sample.
- Storage qualification allows you to specify which states are stored in memory.
- 8 sequence levels determine the sequence of states required for trigger and help you to focus on a specific area of code execution.
- 8 pattern recognizers, 1 range recognizer, or logical combinations of these are used to identify stored states.
- Tagging keeps track of the amount of time or the number of states between stored states.
- Enable/disable can be used to restrict storage to the activity of a specific routine.

### Transitional Timing on ALL Channels Extends the Measurement Range

Each analyzer provides 10 ns timing resolution on every channel. The analyzer stores data only when there is a transition, thus avoiding redundant data storage. 100 MHz transitional timing on all channels effectively extends the memory by lengthening the time covered by the acquisition. Because timing analyzer samples at full speed, events that are seconds or minutes apart are captured with 10 ns resolution. You can use pattern, edge, or duration triggering across all 80 64 or 32 channels when you need to see what is happening around a hardware interrupt or handshake.

### Glitch Capture on ALL Channels

You no longer need to move probes around your system to detect intermittent problems with glitch capture on all channels. You can trigger on and capture 5 ns glitches on all channels of your HP 1650B, 1651B and 1654B analyzers. Glitches are displayed as vertical dashed lines so you can easily distinguish legitimate system activity from glitches.

**Capture the Data You Want to See**

You can trigger on a pattern across the full number of channels, or qualify a pattern by specifying a duration, glitch, or edge. Or, you can specify a pattern duration to capture error conditions indicated by a pattern that exceeds a specified limit. When you need to see what is happening around a troublesome glitch or hardware interrupt signal, use glitch or edge triggering. Use postprocessing to determine statistical variance of edge placement, or detect propagation delays that fall outside of specified values.

**Flexible Data Display Modes Decrease Debugging Time**

Display state acquisitions in one of five forms:

- State listing, which displays your acquisition as a binary, hexadecimal, octal, decimal, or ASCII listing.
- Symbolic/inverse assembler, which displays your data in easy-to-interpret mnemonics.
- State waveform mode, which displays the data in waveform diagram format.
- X-Y chart mode, which displays the value of a data label versus acquisitions or other labels.
- State compare mode, which enables you to compare an acquisition to previously acquired state data.

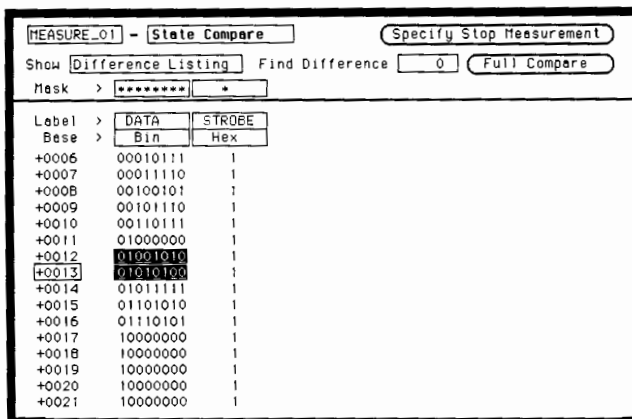

Compare state acquisitions to previously acquired state data. Select channel and range masks to zoom in on important data. Repetitively capture data until compare is equal or not equal.

**Lightweight, Flexible Probing**

Like all HP logic analyzers, the HP 1650B, 1651B and 1654B feature lightweight, flexible, passive probing. Passive probing means lower cost and increased reliability, because no active circuitry is needed at the probe tip. Measurement quality is not sacrificed; each probe only loads your digital system with 100 KΩ and 8 pF.

**Compact and Portable**

With its small footprint, the HP 1650B, 1651B and 1654B fit easily on your workbench, within the same field of vision as what you are working on. At only 22 pounds, these analyzers can be carried easily with the built-in handle or soft carrying case. The case allows you to keep all of the probes and cables conveniently stored on top of the instrument.

**Measurement Compatibility**

Save setup time by transferring state and timing configurations or measurements made with one instrument to another. Make measurements in the field with confidence that the setups and data can be reproduced later in the lab. Use a 3 1/2 inch disk to transfer data from one analyzer to another. Use the HP 10392A state-to-pattern generator link to transfer activity captured in the field to the HP 16500A digital pattern generator to duplicate failure modes in the lab.

**Programmability over HP-IB or RS-232**

You get both HP-IB and RS-232 interface ports as standard equipment on the HP 1650B, HP 1651B and 1654B. You can program front panel functions from either interface, or send hardcopy output to HP-IB or RS-232 printers.

**Built-in Upgrade Path**

The HP 1650B/1651B feature a built-in upgrade path to the HP 1652B/1653B logic analyzers with built-in oscilloscopes. You can get a 32- or 80-channel analyzer now and upgrade with a 400 MSa/s oscilloscope when the occasion arises.

**The HP 1651B and 1654B . . . for 8- and 16-Bit Microprocessor Applications**

The HP 1651B and HP 1654B offer all of the features of the HP 1650B, except channel count (and state speed on the HP 1651B) For debugging most 8-bit processors, or to monitor timing activity across up to 32 channels, the HP 1651B is the ideal tool. For debugging 16-bit processors, or to monitor 8-bit processors with extra channels for timing analysis, the HP 1654B is the perfect match.

	HP 1650B	HP 1651B	HP 1654B
Timing	100 MHz ALL 80 channels	100 MHz ALL 32 channels	100 MHz all 64 channels
State	35 MHz ALL 80 channels	25 MHz ALL 32 channels	35 MHz all 64 channels
Memory	1 Kbit/channel	1 Kbit/channel	1 Kbit/channel
Microprocessor Support	Most 8-, 16- and 32-bit microprocessors	Most 8-bit microprocessors	Most 8-, 16-bit microprocessors

For ordering and pricing information please see page 292.

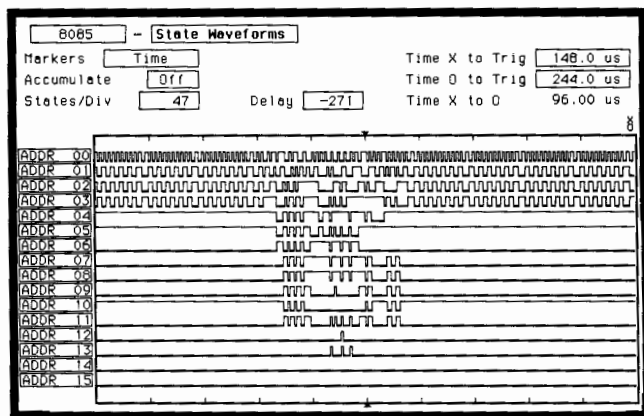

View an entire state acquisition at a glance to examine bus activity or processor control, fully correlated with state listing, X-Y chart and compare modes.

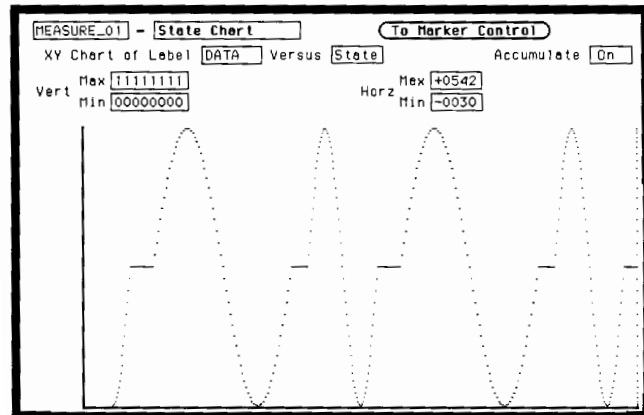

Plot label versus states to check A/D converters or memory coverage. Plot label versus label to obtain a circuit or routine "signature". Correlate chart display to inverse assembled listing.

# LOGIC ANALYZERS

## Portable Logic Analyzers

HP 1652B, 1653B

- 80 channels of state/timing
- 2 channels of 400 MS/s digitizing oscilloscope
- More measurement power at a lower cost than separate instruments

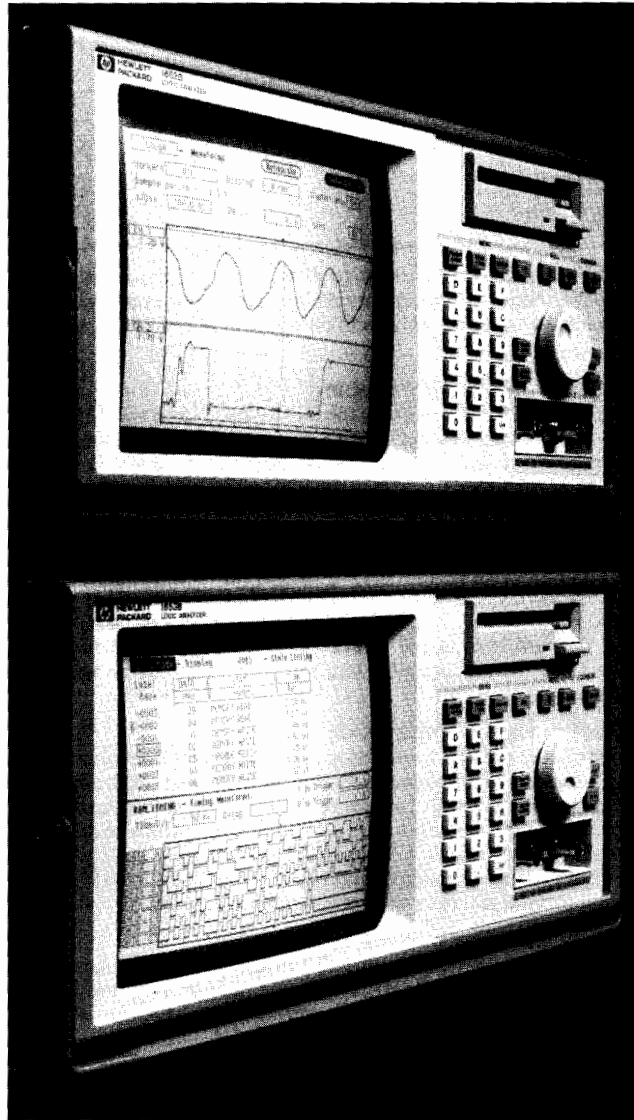

HP 1652B and HP 1653B



- See analog events with a general purpose 100 MHz single-shot BW digitizing scope
- Automatic pulse parameter measurements

### Logic Analyzers with a Digitizing Oscilloscope

The HP 1652B and HP 1653B logic analyzers have all of the features of the HP 1650B and HP 1651B plus two 400 MSa/s digitizing oscilloscope channels, automatic pulse parameter measurements, and time-correlated state, timing and oscilloscope displays. You can still completely analyze your 8-, 16-, or 32-bit microprocessor while getting better definition on system signals with the 2-channel oscilloscope.

You can characterize critical timing parameters with time interval measurements to better than 1 ns accuracy or examine glitches in your system with the built-in scope to determine if noise or loading is the problem. Or, you can use the scope to enhance your troubleshooting capabilities.

### Two Simultaneous 400 MSa/s Analog Channels

Each scope channel is a full-featured, 400 MSa/s, 100 MHz bandwidth oscilloscope. Both channels simultaneously capture non-repeating events with a full 2,048 samples per channel. The built-in scope is based on the same technology used in the popular HP 54502A 100 MHz single-shot BW oscilloscope. The scope features include precision voltage and time interval measurements, autoscale, waveform math, auto-calibration, infinite persistence and averaging display modes.

### Time-Correlated State, Timing and Oscilloscope Measurements

System debugging becomes easier when you display time-correlated state, timing, and analog displays on the same screen. You can see how hardware and software interact, while getting an accurate view of how your system sees the signal.

### Cross-Trigger Measurement Modules

You can use the state analyzer's powerful triggering capabilities to determine when the oscilloscope should trigger.

Glitch triggering on all channels makes the timing analyzer another great tool for triggering the scope. Simply set up the timing analyzer to trigger on a glitch, then trigger the oscilloscope to capture the activity around the glitch. By getting an analog display of the signal, you can determine if the glitch is really a problem.

**Portable Analyzers**

The HP 1652B/1653B portable analyzers are ideal for service applications. Their small size and light weight (just 24 lbs) make them easy to carry to test sites. With the built-in scope, you have two complete instruments in one small package.

**See Pre-trigger Events**

2K sample memory per channel lets you view events up to 5µs before the trigger, while maintaining better than 1 ns time interval accuracy.

**Automatic Pulse Parameter Measurements**

Quickly analyze a signal's analog properties without having to count gratitudes. Choose automatic measurements or time markers to measure voltage and timing relationships. The HP 1652B/1653B automatically measures the following pulse parameters:

- + pulse width
- frequency
- risetime
- peak-peak voltage
- preshoot
- pulse width
- period
- falltime
- overshoot

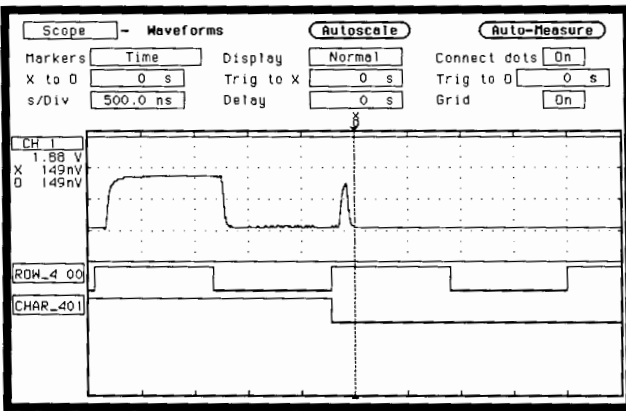

The HP 1652B and 1653B offer full-featured digitizing oscilloscope performance. Time corrected with 100 MHz timing.

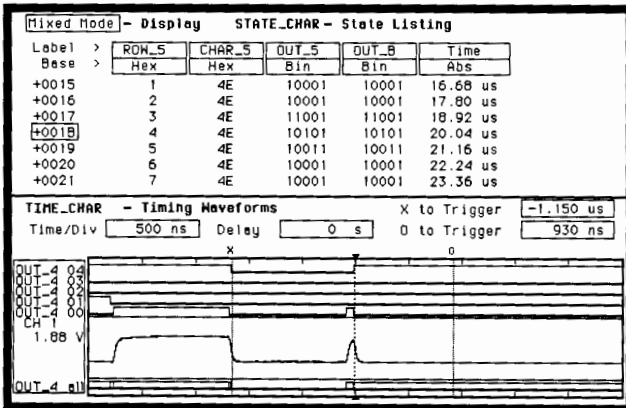

State timing and 100 MHz bandwidth scope all in one portable package.

**Automatic Marker Search**

Using the automatic marker search, you can examine waveforms for specific patterns that could be the cause of a system crash. Or, use the automatic marker search statistics to reveal setup and hold time violations as you make repeated measurements on the system. After each run, the markers are placed on specified patterns, and statistics are compiled on the mean, minimum, and maximum marker placement times, so you can see how often a specific event occurs.

**Hardcopy Output**

After using the built-in oscilloscope to find an elusive problem, use either an HP-IB or RS-232 printer to obtain a permanent record. The HP 1652B and 1653B support over 10 printers.

**All Other Features of the HP 1650B/1651B**

All of the other features of the HP 1650B/1651B logic analyzers are included in the HP 1652B/1653B. These features include 80/32 channels of state and timing analysis, full-featured triggering, built-in disk drives, and support for most popular processors and bus interfaces. Plus, the data and configuration files of the HP 1652B/1653B are compatible with the HP 1650B/1651B/1654B and with the HP 16510B. You can transfer information from one analyzer to another.

	HP 1652B	HP 1653B
Timing	100 MHz all 80 channels	100 MHz all 32 channels
State	35 MHz all 80 channels	25 MHz all 32 channels
Analog	2 - 400 MSa/s 100 MHz BW Simultaneous acquisition channels	2 - 400 MSa/s 100 MHz BW Simultaneous acquisition channels
Glitch Capture	80 channels	32 channels
Microprocessor support	Most 8-, 16- and 32-bit microprocessors	Most 8-bit microprocessors, busses

See page 282 for specifications.  
See page 292 for ordering information.

# LOGIC ANALYZERS

## Logic Analysis Systems

### HP 16500A and Measurement Modules

- Modular, configurable logic analysis system
- Powerful cross-module triggering



HP 16500A

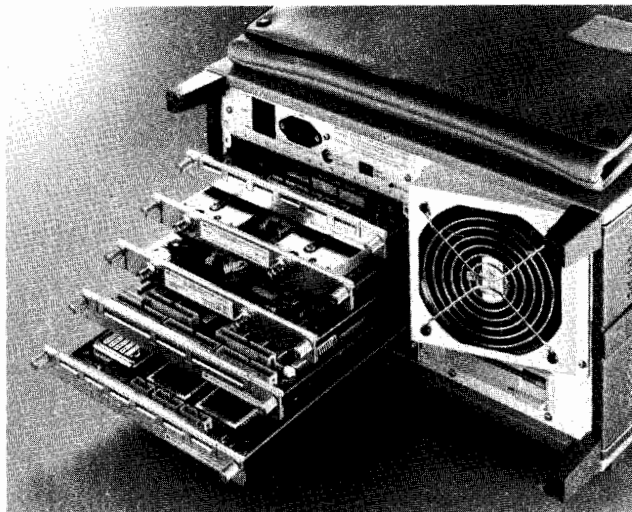

The HP 16500A supports 6 different measurement modules.

- 100 MHz state analysis
- Support for most microprocessors
- 1 GHz timing and pattern generation modules

### HP 16500A Modular Logic Analysis System

The HP 16500A logic analysis system can be configured for a wide range of measurement tasks, including microprocessor debug, hardware design verification and debug, software performance analysis, characterization, and functional pass/fail testing. Start with a focused system, then expand as your needs evolve.

The HP 16500A logic analysis 5 card slots accept 6 different measurement modules. With the HP 16500A, you can do the following:

- Customize your own system by adding cards to the five card slots.
- Make time-correlated measurements between cards using the intermodule bus.
- Compare hardware measurement data with design simulation data.
- Program the HP 16500A with easily understood commands through HP-IB or RS-232C built-in interfaces.
- Store setups and measurement results in either of two built-in disk drives for fast recall or permanent record.
- Generate report-quality documentation with pushbutton ease.

### Color Touchscreen, Mouse, and Keyboard

Save time and reduce errors with the HP 16500A color touchscreen. Simply point to the field you want to change; the touchscreen eliminates the need to search a front panel for the right button. Pop-up menus offer all choices at a glance, and the software does not allow you to make an incorrect choice. Front panel operations can also be executed via mouse and/or keyboard providing complete user-interface flexibility.

Color discriminates between overlapped traces and emphasizes important points. In addition, you can customize for personal preference and environmental considerations. Even infrequent users spend less time making measurements and more time analyzing the results.

Data display areas are not touch-sensitive, so there is no need to worry about losing your latest acquisition.

### Use Cross-Domain Triggering for Complex Measurements

Use state to arm timing, or use timing to arm state when the symptom of a problem is best isolated with one analyzer and the cause is best isolated with the other. For example, track a microprocessor program flow around a hardware interrupt. Find the edge of the interrupt signal with the timing analyzer. After the signal is found, the timing analyzer can arm the state analyzer to start acquiring data.

**Perform Time-Correlated State Analysis of Multiple Microprocessors**

In multiple microprocessor environments, systems are driven by multiple clocks. The HP 16500A/16510B provides simultaneous capture of separately clocked systems while time-tagging all states. You can capture the states from several microprocessors, then analyze their flow with interleaved, time-correlated state displays. You can monitor up to 10 independently clocked microprocessor systems with 5 HP 16510B modules while monitoring the activity with state-to-state time-correlated listings or monitor multiple RISC systems at speed with the HP 16540A/16541A.

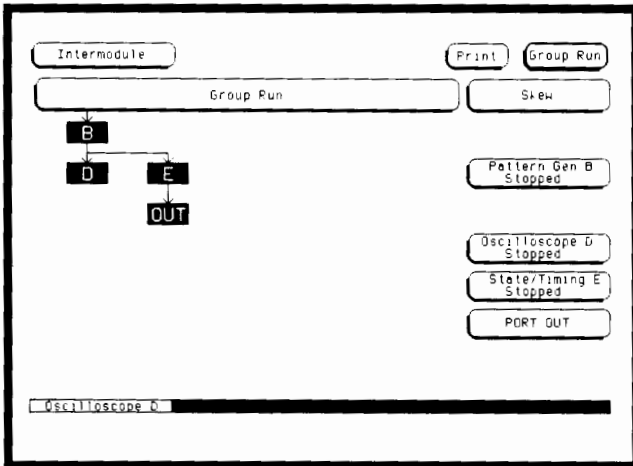

With the HP 16500A intermodule bus you can arm or trigger one measurement module from another.

**Configure Your System**

The HP 16500A logic analysis system can be configured for your debug, characterization, systems integration, or pass/fail testing applications. Start with a focused system, then expand it as your needs evolve. For example, start with an 80-channel logic analyzer and a 2-channel oscilloscope, then add more capability as needed.

**High Performance System**

Verify or analyze the performance of circuits through combined analog, state, and timing measurements. The five card slots hold state/timing cards, timing cards, pattern generator cards, and digitizing oscilloscope cards. Use these cards in combination to make measurements that could not be made with separate instruments. For example, state can arm both oscilloscope and timing waveform capture, allowing you to display a mixture of timing and scope waveforms on screen to measure time relationships between events.

**Store Setups and Data Quickly**

It is easy to store and retrieve measurement results and setups with the two built-in 3 1/2 inch disk drives. Use the back disk drive for the operating system, leaving the front disk free for measurement files.

**Correlate 1 GHz Timing with Oscilloscope Waveforms**

Connect several 1 GHz timing lines while probing simultaneously with oscilloscope channels. For example, configure 32 channels of 1 GHz timing with 4 oscilloscope channels to provide time correlation from a single trace point. This procedure allows you to capture the number of channels you need while simultaneously capturing parametric information.

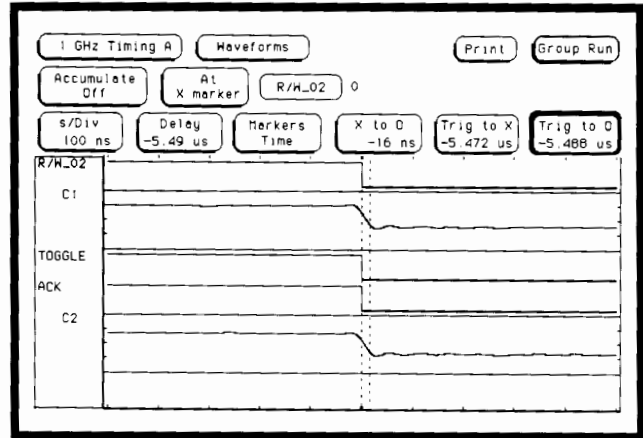

1 GHz timing waveforms time-correlated with 400 MSa/s digitizing oscilloscope waveforms.

**Application Driven Trigger Selection**

Select the trigger mode that best suits your application. Use glitch, state, analog, or timing triggers to capture state, analog, and/or timing data. To analyze interrupt handling in a microprocessor system, use the oscilloscope to arm timing, state, and analog on the asynchronous interrupt. Then capture microprocessor program flow with state, capture control lines with timing, and capture the interrupt line with the scope. The HP 16500A logic analysis system connects state, timing, analog, and pattern generation trigger qualification serially or in parallel in any order to meet your needs.

**Generate Patterns Interactively**

Generate patterns triggered by the intermodule bus or by the pattern generator's external qualification. The intermodule bus provides state, analog, timing, and/or pattern generator program flow qualification. Test your circuit's response to patterns derived from simulation, for rigorous functional analysis of prototypes. You can quickly generate pattern generator programs using the HP 10392A state-to-pattern generator link.

See page 282 for specification.

See page 292 for ordering information.

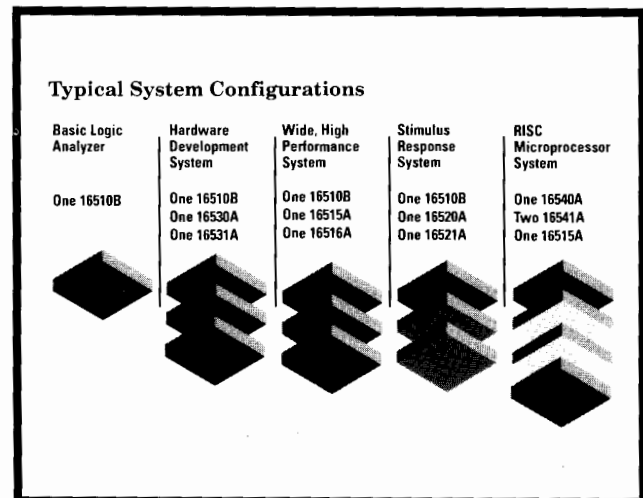

# LOGIC ANALYZERS

## State and Timing Analysis Modules

### HP 16510B, 16511B



#### HP 16510B, HP 16511B State/Timing Module

##### Full-Featured State Analysis

The HP 16510B offers 80 channels of full-featured state and timing analysis. You can configure up to 400 channels of state and timing in the HP 16500A frame, or examine up to 10 processors at the same time. Each HP 16510B can operate as a separate state/timing analyzer, while time correlation is available over the HP 16500A intermodule bus (IMB).

#### Trigger Across 160 Channels

Simplify data tracking through pipelined architectures with the use of the HP 16511B 160-channel 35 MHz state/100 MHz timing module. You can trigger across all 160 channels, making the flow through the pipeline easier to follow.

Trigger on complex handshaking routines across several synchronous processors and display all of the data on the same screen to debug multiprocessor systems. RISC, wide bus, and ASIC integration tasks become easier when you can look at all of the data with one state or timing analyzer. Data correlation across all 160 channels is built-in; you do not have to create arming sequences.

#### View Activity of two parts of a System

The HP 16510B and 16511B can be configured into two independent state analyzers or a single state and one timing analyzer. Measurements that would normally require two instruments can now be made with a single instrument.

For example, by using the state analyzer to focus on a specific I/O routine, you can watch both the program execution and the activity on the I/O lines with a time-correlated display. Or, when you need to examine the interaction of two microprocessors, the HP logic analyzers can display time-correlated state listings.

#### Use the State Analyzer as a Window to the System

When a trigger sequence is too complex for the scope, use the state analyzer's powerful 8-level, 8 resource term trigger to locate the problem; then use another measurement module to get a detailed picture of the fault. The state and timing analyzer can be used together to define when a problem occurs and then either arm or trigger the HP 16530A/16531A oscilloscope or HP 16515A/16516A 1 GHz timing analyzer to capture data. This approach saves time and helps avoid the extra work of finding a problem with a scope alone.

Label	HMIDATA	Time
Base	Binary	Relative
29	11101111	400 ns
30	11101111	1.00 us
31	11101111	400 ns
32	11101111	400 ns
33	11101111	1.00 us
34	11101111	400 ns
35	11101111	400 ns
36	11101111	1.00 us
37	11101111	400 ns
38	11101111	400 ns
39	11101111	1.00 us
40	11101111	400 ns
41	11101111	400 ns
42	11101111	1.00 us
43	11101111	400 ns
44	11101111	400 ns

Time tagging measures the time between states. You can get an accurate picture of the time it takes your system to make the transition from one state to another.

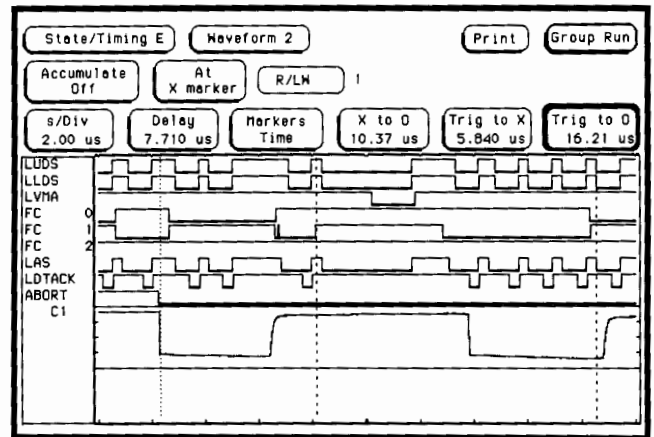

Transitional timing on every channel gives a wide view of system activity. (Shown here with a time-correlated oscilloscope channel.)

#### Measure the Time Between States

With time tagging turned on, you can measure the time it takes your system to make the transition between one state or another. The time information is displayed along with the state data, so you can get a clear picture of an event's duration. Combine state tagging with storage qualification to confirm the length of an information transfer without actually storing all of the data.

#### Transitional Timing on ALL Channels

The HP 16510B and 16511B logic analyzers store timing data only when there is a transition, thus avoiding redundant data. This effectively extends the memory by lengthening the time covered by an acquisition. Because the timing analyzer samples at full speed, events that are seconds or even minutes apart are captured with 10 ns resolution. Use transitional timing for analysis of asynchronous data buses, where activity often occurs in bursts, followed by long periods of dead time.

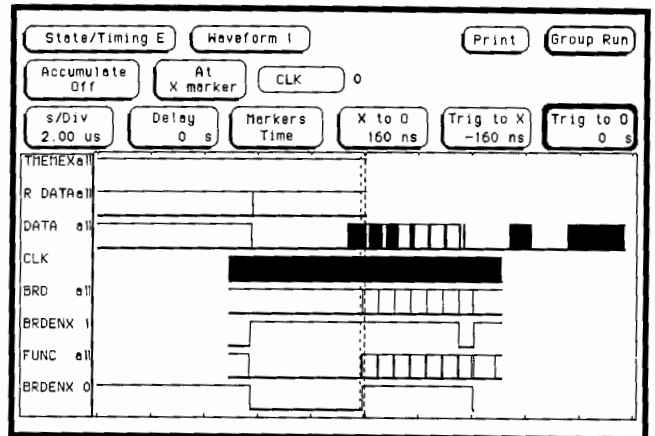

Transitional timing captures 20 $\mu$ s of data with 10 ns resolution.



**Use Postprocessing to Snare Elusive Timing Faults**

Use the timing analyzer's postprocessing to find setup and hold violations. Use the specify-stop-measure feature to acquire data until the time interval between two patterns violates a specified condition. Transitional timing can supply a long pre-trigger record length, so you can look back in time to discover the cause of the problem.

**System Performance Analysis**

The HP 10390A system performance analysis software (SPA) provides an overview of system activity. It can be used with another state machine in the same analyzer to find the activity of interest in order to make time interval measurements. Or, it can be used in state overview mode to help identify execution segments as prime targets for optimization.

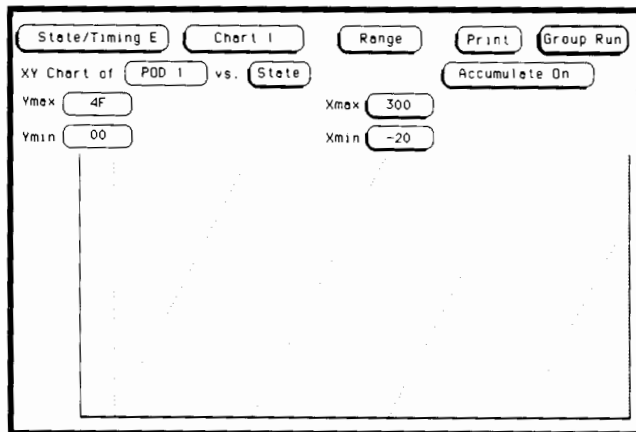

Chart mode shows characteristic signature of a memory read cycle.

**Debug Microprocessors**

HP preprocessors tailor the HP 16510B and 16511B to microprocessors from Intel, Motorola, Zilog, National, Hitachi, GTE, Rockwell, and NEC. These preprocessors simply plug directly into the CPU socket. Companion software converts the acquired state data to microprocessor mnemonics, making it easy to monitor program execution. See pages 262 through 264 for microprocessor and bus interface support details.

For designs that use custom or proprietary CPUs, use the HP 10320C user-definable interface to connect HP logic analyzers to your system. The HP 10391B inverse assembler development package can be used to develop custom software that converts the acquired state data to CPU mnemonics.

```

State/Timing E  Listing 1  Invasm  Print  Run
Markers
Pattern  Find  1  from
a-pattern  Trigger
Pattern> 00001000
Label>   ADDR 68020 Mnemonic
Base>    Hex  decimal ($ = hex)
2  0000FE0  MOVEC  CACR, D0
3  0000FE4  BCHG  #00, D0
4  0000FE8  MOVEC  D0, CACR
5  0000FEC  MOVE L  #00090000, #00090000
6  0000FF0  #00000009  supr prgm read
7  0000FF4  MOVE L  #00000202, #00090004
8  00090000  #00090000  supr data write
9  0000FF8  #00000202  supr prgm read
10 0000FFC  #00090004  supr prgm read
11 00001000  MOVE W  #7FFF, D7
12 00090004  #00000202  supr data write
13 00001004  MOVEA L  #001C0000, A0
14 00001008  MOVEA B  #00, (A0)
15 0000100C  DBF  D7, #0000100A
16 00001010  MOVE W  #0----, D7
17 001C0000  #00xxxxxx  supr data write
    
```

A Motorola 68020 inverse assembly listing.

Model	HP 16510B	HP 16511B
Timing	100 MHz all 80 channels	100 MHz all 160 channels
State	35 MHz all 80 channels	35 MHz all 160 channels
Memory	1 Kbit/channel	1 Kbit/channel
Triggering	8 Levels, each with branching, store qualification, complex pattern recognition	

```

State/Timing E  Compare 1  Print  Run
Difference listing  Find Error  Compare  Specify Stop
                  0          Full  Measurement
Mask>  * * * * *  * * * * *  * * * * *  * * * * *
Label>  ADDR  DATA  STAT
Stop measurement
when Compare is Equal
Done
21 001C0000  00000000000000000000000000000000  155
22 0000100B  000000000000000000001000010111100  063
23 0000100C  00000000000000000000101000111001111  063
24 00001010  1111111111111010001111000111100  063
25 001C0000  00000000000000000000000000000000  155
26 0000100B  000000000000000000001000010111100  063
27 0000100C  000000000000000000101000111001111  063
    
```

Use the state analyzer compare mode to identify faulty states.

See page 292 for ordering information.

# LOGIC ANALYZERS

## State Analyzers

HP 16540A, 16541A



### HP 16540A, 16541A 100 MHz State Analyzer

The HP 16540A/16541A 100-MHz state analyzer offers full-featured 100 MHz data capture and analysis. You can configure up to 208 100-MHz channels with 4K deep memory. Powerful four-level sequencing, with pattern and range recognizers, storage qualification, and per-level branching helps you find elusive system errors. Adjustable setup and hold time enables the HP 16540A/16541A to capture data reliably, even from ECL systems.

The HP 16540A/16541A also offers all of the software features found in the 35 MHz model 16510B, including chart mode, compare, and system performance analysis (SPA). The HP 16540A/16541A is fully programmable.

When you use the HP 16540A/16541A as part of a complete logic analysis system, you can correlate 100 MHz state measurements with other modules, such as the HP 16515A/16516A 1 GHz timing, or the HP 16530A/16531A 400 MSa/s digitizing oscilloscope module, to speed debug.

### 100 MHz State Gives You the Margin You Need

Today's RISC processors already operate at bus rates up to 70 MHz. Because clock rate increases are one of the fastest ways to increase processor performance, there is no doubt that bus rates will increase. The HP 16540A/16541A has full performance up to 100 MHz, giving you the margin you need for today's and tomorrow's systems.

### Full Support for Popular RISC and CISC Processors

The HP 16540A/16541A brings you the broadest RISC processor support available. RISC/CISC processors supported include the following:

- AMD AM29000
  - Intel 80860, 80960, 80386, 80486
  - MIPS R2000/3000/4000
  - Motorola 88000 (88100 and 88200), 68030, 68040
- Your design might include the use of an industry standard backplane bus. HP supports a range of backplane buses, including:
- VME A and B Size
  - SCSI I and SCSI II
  - EISA
  - MCA (IBM's Microchannel architecture)
  - Fiber Digital Data Interchange (FDDI)
  - MIL-STD 1553

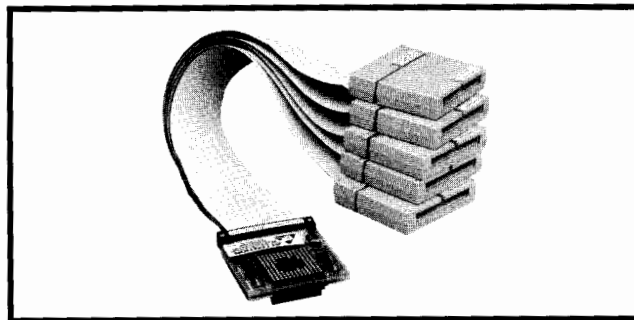

HP E2406A

Each microprocessor or bus support package includes a preprocessor interface, which gives you quick and easy connection to your target system. Inverse assembly software translates acquired states into processor-specific mnemonics.

### The Software Features You Expect

Chart mode displays signal values versus samples. It can be used to display digitized video signals, highlight non-linearity in an A/D, or obtain a characteristic overview of your processing system. Use the correlated markers to trace problems with a timing analyzer or digitizing oscilloscope.

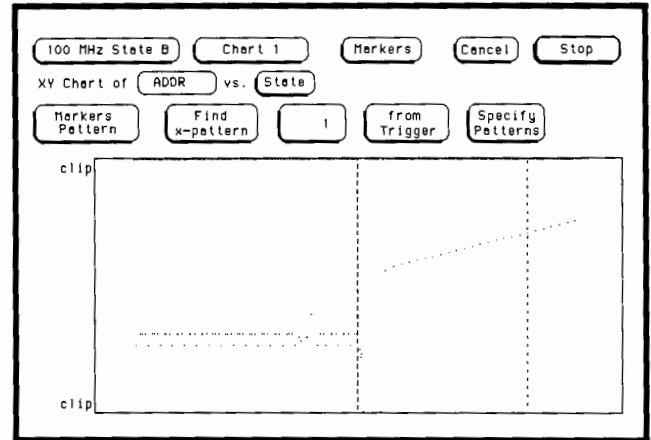

Chart mode display of routine's memory access. Chart mode provides at a glance an overview of the memory addresses called by the routine. Illegal memory access can quickly be identified.

Detect processing errors by comparing measured and expected results while running your system at-speed. Compare mode allows you to compare just the section of code you are interested in. Compare images can be edited from the front panel or by program control.

System performance analysis (SPA) software (HP 10392A Option 003) helps you characterize the performance of your system. Use SPA to determine where system bottlenecks occur or to optimize I/O routines or data transfer times.

State histogram mode lets you break your system into small ranges that correspond to natural boundaries in your system. A trace shows you the operations on which your system spends its time.

Time interval mode helps you characterize activities such as data requests and packet transfers or detect error recovery procedures that take too long.

### Trigger at Speed with Confidence

Who called this subroutine? How is this interrupt handled? High-performance systems change states every clock cycle. Many times, the only solution to a tough problem is to trigger on 2 or more concurrent states. The HP 16540A/16541A has a powerful four-level sequencer that operates to 100 MHz, with no tradeoffs between speed and performance.

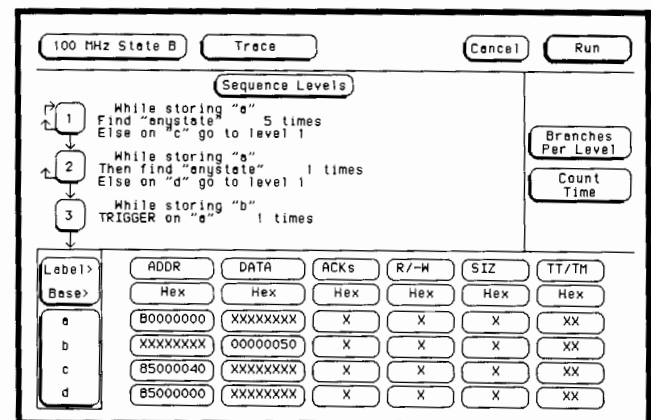

Trigger sequence capturing a write cycle on an 88000.

### Capture All Critical Circuit Activity

Is your cache memory system working properly? Is your multiprocessor system optimized? Is data flowing through your pipelined architecture correctly? Use the HP 16540A/16541A to examine both processor activity and supporting circuit behavior in your system. Most processors require between 80 and 160 channels for support. With the HP16540A/16541A, you can probe and trigger across up to 208 channels simultaneously. You can also probe your data pipeline at each stage of the system, using different labels to make tracking of data flow easy.

### Monitor Time Between Events

When optimizing high-performance systems, you need to keep track of what happened when. Time tagging allows you to measure the time between critical system events such as interrupt handling, subroutine calls, or secondary memory accesses. With the HP 16540A/16541A, you can track these events to the full 100 MHz speed of the analyzer.

Measuring data-transfer time is also easy with the HP 16540A/16541A. Use the sequencer to store only the first and last states in a data packet. The instrument can then display the time between states to obtain the transfer time.

### Compatibility Protects Your Investment

The HP 16540A/16541A probes are compatible with HP 1650-family and HP 16510A/B-series probes. Many preprocessors used with the other 16500-family products can be used with the HP 16540A/41A. The HP 16540A/16541A user interface is nearly identical to the HP 16510B, so you can set up measurements quickly.

Because most high-performance designs take advantage of surface-mount (SMT) technology, SMT grabbers are included with the HP 16540A/16541A. These grabbers are specially designed to attach securely to SMT parts while keeping sufficient clearance from other pins. Other surface-mount probing accessories are also available from HP; see page 280 for more details on accessories.

### Affordable 50 MHz Stimulus-Response System

Use the HP 16520A/16521A digital pattern generator as a stimulus, and the HP 16540A/16541A as a response. Functionally test your digital system at speeds up to 50 MHz. State compare mode can be used to verify results. Both modules are fully programmable.

Model number/Type	HP 16540A: Master Card HP 16541A: Expansion Card
State Mode	100 MHz
Memory Depth	4K
Triggering	Four sequence levels, each with store qualification, two-way branching, pattern recognition with Boolean combinations, range recognizer, Inter-module Bus triggering.

See page 289 for specifications  
See page 262 for microprocessor support  
See page 292 for ordering information



# LOGIC ANALYZERS

## Digitizing Oscilloscope Modules

HP 16530A, 16531A

### HP 16530A, 16531A Oscilloscope Time Base Card Built-in Full-Featured Scope

The HP 16530A/16531A offers the advantages of a full-featured digitizing oscilloscope, integrated into your logic analyzer. You get a full 100 MHz analog-equivalent bandwidth scope with digitizing advantages such as autoscale, automatic measurements, powerful triggering, and negative time viewing.

Arm or trigger the oscilloscope from any other module in the HP 16500A logic analysis mainframe. You can capture and display the analog events that affect the digital system. Correlate the oscilloscope to state listings and timing waveforms to identify cause and effect relationships.

#### Correlate Single-shot Events with Precision Time Interval Measurements

Make time interval measurements with markers at better than 1 ns accuracy single-shot (after deskewing). Accuracy at the probe tip is ensured by a front panel calibration routine that reduces channel-to-channel skew. You can also calibrate for delays caused by uneven probe lengths, to ensure that the measurement is correct.

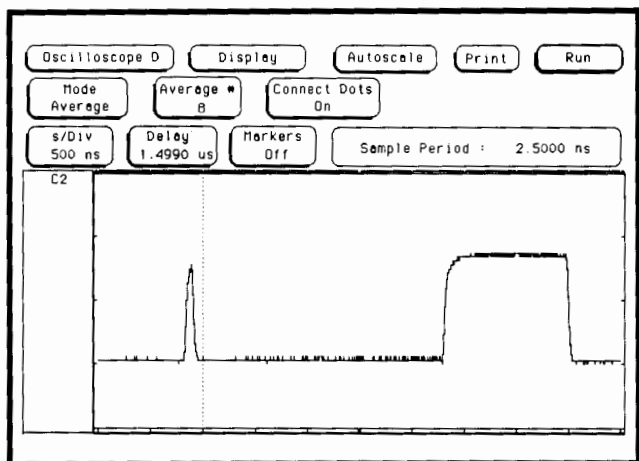

The HP 16530A/16531A Digitizing Oscilloscope finds a glitch

#### Single-shot Analysis

The HP 16531A 2 channel, 400 Megasamples/s digitizing oscilloscope captures 100 MHz bandwidth signals single-shot. You can capture up to 8 channels simultaneously to determine relationships between infrequent events. A high-resolution color display and post-capture scroll and zoom allow detailed examination of waveforms.

#### Capture Many Waveforms Simultaneously

Run up to four HP 16531A oscilloscope cards with a single HP 16530A timebase card for simultaneous acquisition. The HP 16530A/16531A oscilloscope module can be configured to acquire from two to eight signals simultaneously. Save time when debugging and characterizing systems by observing multiple test points during each test.

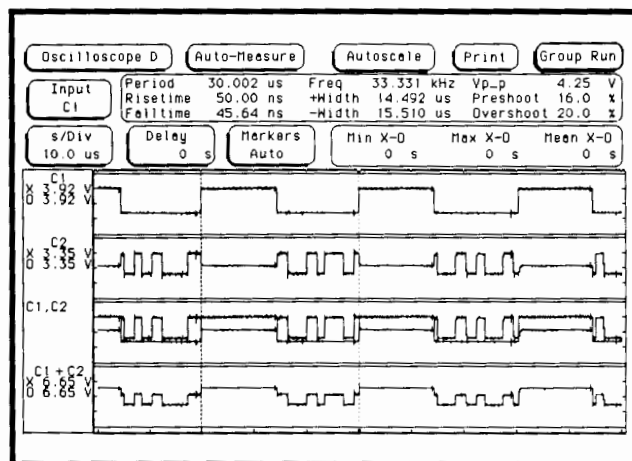

Waveform math functions are available

#### Measure Slow and Fast Events Simultaneously

Use the 4K sample depth to measure periods and time intervals. Then zoom in for rise time measurements. Add a second oscilloscope module to create a dual time base digitizing oscilloscope, and to display events with different time bases on the same screen.

#### Find the Causes of Errors

Each channel has 4K memory depth for capturing events before or after the trigger event. View events up to 10  $\mu$ s before the trigger event with greater than 1 ns accuracy.

#### View Analog and Digital Waveforms . . . and More

Capture random signal variations with the Accumulate mode. Filter out noise with Average mode. Show true single-shot events with Single mode. Scan many periods of the waveform easily with the Connect-the-dots feature. View analog-like waveforms with 6 bit vertical resolution. Analyze differential waveforms with the A-B mode. The HP 16530A/16531A gives you all of the features of a digitizing oscilloscope plus the power of a logic analyzer in one frame.

#### Automatic Measurements

Automatic pulse parameters allow fast analysis without having to count gratitudes. Parameters such as frequency, period, pulse width, peak-to-peak voltage, maximum voltage, minimum voltage, risetime, falltime, preshoot, and overshoot require just one keystroke. Measure voltage and timing relationships by placing the markers and reading the results on the display. Display the time between markers, acquire until capturing specified time between markers, or perform statistical analysis on the time between markers. Setup is easy with automatic waveform scaling, TTL & ECL presets and automatic marker placement on specified edges.

Model	HP 16530A, HP 16531A
Channels	2, 4, 6, 8
Bandwidth (-3dB)	dc - 100 MHz
Maximum sample rate	400 MSA/s
Waveform record length	4,096 points
Triggering	edge, pattern, other modules, external, event

See page 282 for specifications.

See page 292 for ordering information.

### HP 16515A/16516A Timing Analyzers

#### Affordable 1 GHz Timing

Measure precise time relationships to 1 ns resolution with the HP 16515A/16516A 1 GHz timing analyzer. Make time interval measurements or view the order of events in your high-speed system with 1 ns single-shot resolution on every channel. There is no need to compromise channel count for sample speed. Every channel runs to the full 1 GHz sample rate.

Debug quickly with up to 80 channels of 1 GHz timing in one HP 16500A logic analysis mainframe. More channels means that you can avoid having to move probes in order to find the problem. 16 channels of 1 GHz timing complements the HP 16510B 100 MHz timing to help you get a clearer picture of critical timing behavior.

#### Find the Cause of Problems with 8 Kbit/Channel Memory Depth

Find and analyze events that occur before or after the trigger event. Each channel stores 8 Ksamples to allow 8  $\mu$ s of negative time capture with 1 ns resolution for pre-trigger applications. Deep memory stores data over many clock cycles while retaining precise edge placement information. Deep memory also helps you find elusive problems more quickly when you're not sure exactly where to trigger.

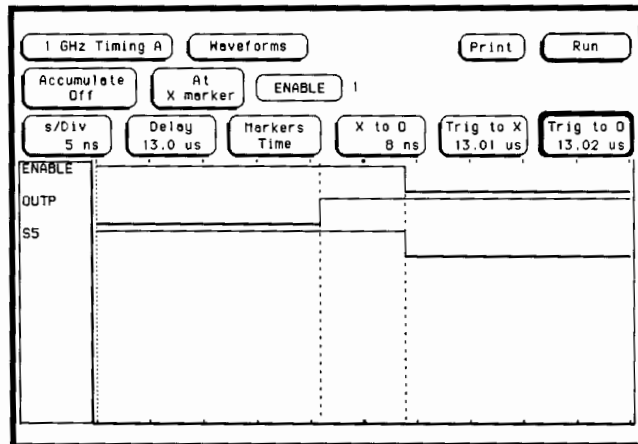

Make time interval measurements with 1 ns resolution.

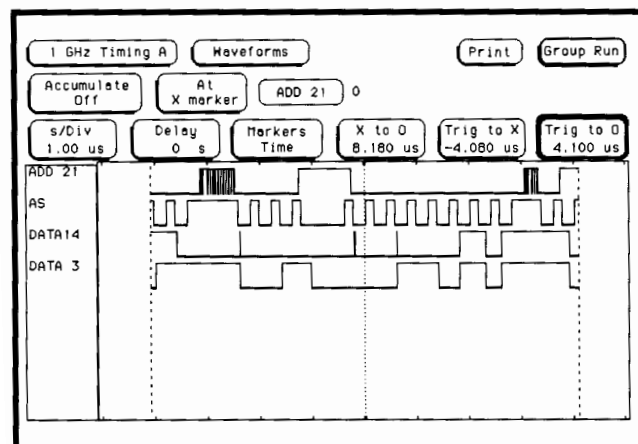

Capture 8  $\mu$ s of circuit activity with a 1 ns sample period.

#### Hook Up Easily to Your Circuit with Lightweight Probes

Lightweight 10k $\Omega$ , 2 pF passive probes are easy to connect. These probes can be connected with probe tips or plugged directly into any .1 in grid with .026 in to .033 in diameter round pins or .025 in square pins. Individual grounds are provided for each channel to shorten ground loops.

#### Correlate 1 GHz Timing with Other Modules

Use the state analyzer to find the problem, then examine events around it with 1 ns resolution. Display state, timing and analog activity on the same screen. Use the automatic pattern search and specify-stop-measurement to determine if timing violations occurred

#### Time Interval Accuracy

Time interval accuracy is more than just channel skew. The HP 16515A/16516A's time interval accuracy is specified, and includes all parameters which affect your critical time interval measurements - the only high performance logic analyzer that does.

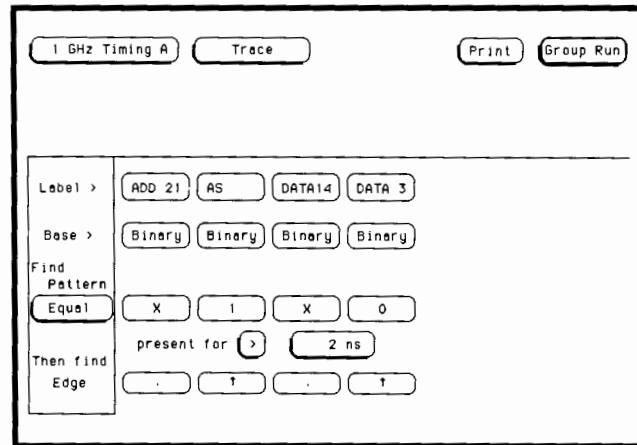

Use the pattern duration trigger feature to filter unwanted triggers.

	HP 16515A	HP 16516A
Channel Count	16	16
Memory Depth	8,092	8,092
Maximum Sample Rate	1 GSa/s	1 GSa/s
Triggering	Pattern, pattern duration, edge, other modules	

# LOGIC ANALYZERS

## Pattern Generator Modules

HP 16520A, 16521A



### Functionally Test Your System

The HP16520A/16521A digital pattern generator modules are the perfect tools for functional test of a digital design. Standard 3M<sup>1</sup> connectors eliminate the need to design custom test points onto your PC board. With the HP 16520A/16521A providing the stimulus, you can use any of the HP 16500A acquisition modules to determine whether the system is responding correctly.

### Pattern Generator Benefits

During the prototype debug phase of design, digital pattern generators offer several benefits. Pattern generators can simulate signals from not-yet-completed parts of the system, such as backplane buses, other PC boards, or peripherals. Pattern generators allow you to check the functional characteristics of your system and also allow you to see how your system responds to unanticipated signals. You can perform margin testing, to determine exactly when your system fails.

### Easy Pattern Development

Eliminate the painful process of developing test patterns by hand. Use the HP 10392A state-to-pattern generator link to obtain patterns from a known good system or from the interface you want to simulate. The HP 10392A translates these patterns to the pattern generator. You can specify which control lines you want assigned to the pattern generator's return-to-zero (RZ) lines, and simulate complex data sequences by using the state analyzer's time tagging information.

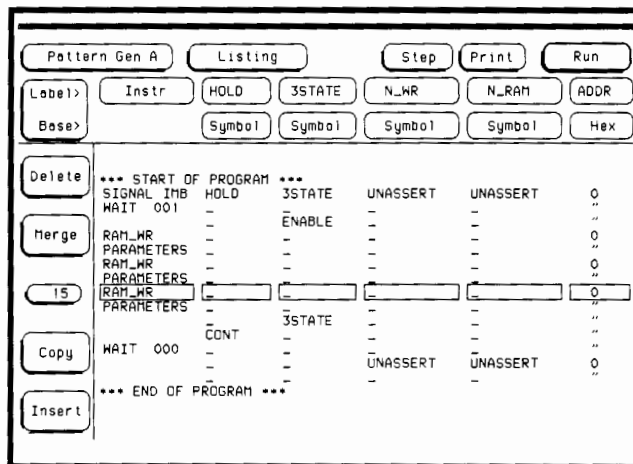

Symbols can be used to display data in your system's mnemonics, making debug and documentation easier.

### Get the Patterns You Need from Simulation

If the patterns you need were developed as a result of a simulation, you can now transfer this information to the HP 16500A pattern generator and state analyzer. To speed your design confirmation efforts, the HP 16520/16521A digital pattern generator can accept data from most popular commercial simulators.

### Digital Stimulus and Response

Configure the HP 16500A to provide both stimulus and response in one instrument. The pattern generator runs the device-under-test through an initialization sequence, then tells the state analyzer to begin making measurements. During the measurements, use state compare to determine if the device is functioning properly.

Up to 108 channels of stimulus and 160 channels of response can be installed in one frame, or 208 channels of stimulus and 320 channels of response can be installed in a 16500A/16501A system.

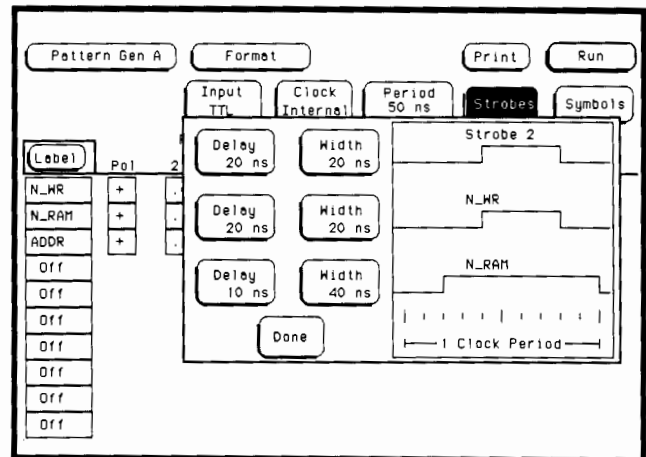

Three return-to-zero channels can be adjusted via pop-up windows.

### Low Volume Manufacturing Test

Use the HP 16500A with digital pattern generation and state response as a low-volume manufacturing test system. The standard 3M<sup>1</sup> connectors make hook-up easy. The user interface, learn string capability, and standard HP-IB/RS-232 interfaces support fast test development.

### Failure Analysis

Use the HP 16520A/16521A digital pattern generator to track down and repeat failures, then use state or timing analysis to transfer data on the failure back to a computer for more analysis. The data can be transferred to many popular testers in order to enhance test program development.

### Easy Operation

Only two menus are needed for complete data entry; a format and a listing menu. The format menu allows you to group data channels together for easy data entry. Enter data in hex, octal, binary, decimal, or symbols. Editing is enhanced with delete, insert, and copy functions. You can merge stored programs to create more complex data files quickly. Macros allow you to repeat portions of code quickly. Symbols can be generated to replace complex data patterns.

To allow pattern generation when complex trigger conditions occur, derive run control for the pattern generator from the screen, external sources, or intermodule bus.

### Quick Circuit Connection

Easily attach to boards through probe tips or 2 x 10, .1 in center connectors on your circuit board. Standard connectors eliminate the need to purchase special connectors or to build custom fixtures to hook into your DUT. The lightweight and passive probing system provides ECL or TTL patterns through 50 ohm connections. Series termination eliminates the need for external 50 ohm terminations. Generate ECL Differential, TTL or CMOS Tristate patterns with the 10345A ECL Differential Driver, the HP 10346A TTL Tristate Pod, or the 10348A CMOS Tristate Pod.

	HP 16520A	HP 16521A
Channel Count	12 NRZ, 3 RZ	48 NRZ
Memory Depth	4095	4095
Maximum Data Rate	50 MBits/s	50 MBits/s
Output Levels	ECL, TTL CMOS <sup>2</sup>	ECL, TTL, CMOS <sup>2</sup>

<sup>1</sup> 3M is a registered trademark of Minnesota Mining and Manufacturing.

<sup>2</sup> CMOS voltage levels require an HP 10348A, CMOS buffer pad.

#### Simulation Vectors for Hardware Verification

Perform functional verification of your simulated design by transferring and translating simulation vectors to the HP 16500A logic analysis system. You can compare actual circuit behavior with simulation results to detect and isolate design faults. By using simulation vectors as the basis for your prototype verification, you can develop just the tests you need to verify that your design works.

#### CAE Link Benefits

Links between simulation and prototype test save you time. For functional prototype verification you can quickly and easily transfer and translate just the test vectors you need. CAE Links eliminate manual reentry of test vectors and make the development of test suites easy. As a result, products get to market sooner.

An added benefit of CAE Links is the ability to transfer prototype test vectors to manufacturing test. You can develop a core set of test vectors, make sure that they fully test your product's functionality in the lab, then hand the completed design and test vectors to manufacturing.

#### Acquire Test Vectors from Known Good Boards

Reduce the time spent on tedious entry of zeros and ones while creating manufacturing tests. Use the HP 16500A state and timing modules to gather the data for you from a known good board. With the 1 ns resolution of the HP 16515A/16516A, you can develop tests for the most demanding designs and most complex testers.

Connect the HP 16500A acquisition modules to the known good board and make successive data acquisitions. You can then modify this data and transfer it to your board or IC testers as a complete test program!

#### Begin Your ASIC Design Cycle with Real-World Test Vectors

Before beginning your next ASIC design, capture test vectors from the systems that it will be designed to replace. Use the HP 16500A to acquire a representative sample of data from key nodes in the system. Then transfer the test vectors back to the simulation environment for use as behavioral test data. This process lets you verify that your ASIC design behaves properly in your system before you send it to the foundry.

#### Analyze and Correlate Production Tester Behavior with Simulation

You can correlate the behavior of your device under test with simulated behavior by using the HP 16500A state and timing modules. These permit you to monitor behavior of the device while it is in the test fixture. In turn, the captured data can be compared to simulated data to determine if the test, tester, or design is at fault.

#### Protect Your Test Development Investment

Protect your test development investment by using the HP 16500A to transfer tests developed on one tester to another. The HP 16500 can capture your test program with 1 ns resolution. This information can be used to reconstruct test programs for another tester.

#### HP and TSSI: Working Towards Your Productivity

The HP 16500A is supported by Test Systems Strategies, Inc. (TSSI) of Beaverton, Oregon (USA). TSSI markets software that links design and test. TSSI supports most simulators in addition to supporting many popular ASIC Verification, IC and board testers. For more information on TSSI, contact your HP sales representative.

TSSI software supports the HP 16500A pattern generator modules and all HP state and timing analyzers. You can capture system behavior with any of these analyzers, and then transfer that information to TSSI's proprietary waveform database where it can then be transferred to testers or simulators.

TSSI also supports the compare mode found in all HP state analyzers. This means that you can compare simulation results with acquisitions to detect system faults.

TSSI software runs on DEC VAX, Apollo 3000 and 4000 Series, HP 9000 Series 300, and SUN 3/Series computer systems.

#### CAE Simulators Supported by TSSI

Most popular commercial simulators and many proprietary simulators are supported by TSSI. The list of supported commercial simulators includes: Calma TEGAS/TEXOUT/TEXSIM; Daisy Logician DLS; Gateway Verilog; HP EDS; HHB Systems CADAT; LSI Logic, Lattice Logic Expert; Logic Modeling Systems; Mentor Graphics QuickSim; QuickTurn; Silicon Compiler Systems LSim; Silvar-Lisco Logix/Helix; SimuCad SILOS; Teradyne LASAR; Valid Logic ValidSIM; Vantage; Viewlogic ViewSim; and ZyCad ZILOS.

#### Popular Testers Supported by TSSI

Many ASIC verification, board, and IC testers are supported, including the HP 82000 ASIC Evaluation System, HP 3065/3070 series board testers, and the HP 9480 Analog LSI Test System. For more information on tester support, contact your HP sales representative.

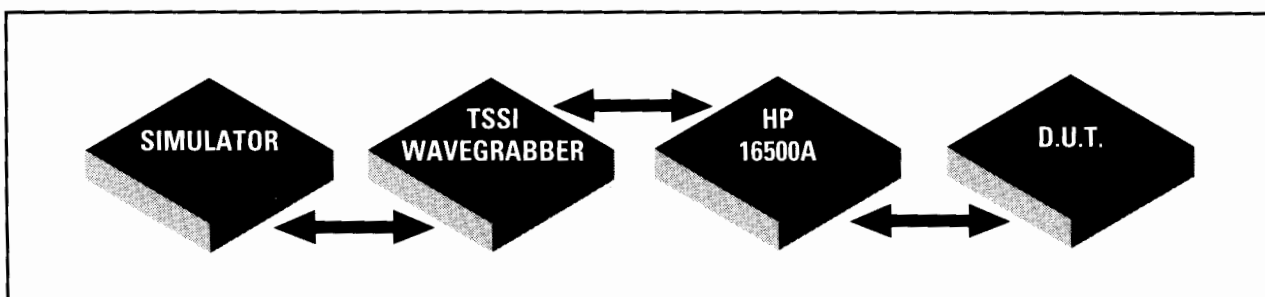

# LOGIC ANALYZERS

## Accessories

### Accessories for HP Logic Analyzers

Logic analyzer accessories make your measurement tasks easier. Probing accessories, such as HP termination adaptors allow you to connect to your target system with industry standard 3M\* connectors. With the wide range of HP oscilloscope probes you can choose the impedance that best matches your measurement.

### Easy and Quick Connection to Your Circuit

HP offers a wide range of probing solutions. You can use the general-purpose probes, which consist of flying lead sets and grabbers, to make measurements while you are debugging a circuit. HP offers two types of grabbers. A general purpose grabber is shipped with the HP 165X family of logic analyzers and the HP 16510B. A surface mount grabber is shipped with the HP 16540A/41A 100 MHz State Analyzer. A complete set of general-purpose probes comes with each analyzer.

For a more permanent connection to your target system, you can use the 01650-63203 termination adaptor or the 16515-63202 high speed timing termination adaptor. The termination adaptor connects the logic analyzer's probe cable to your target system via a flexible 3M connector. The connection to your device under test consists of a 2 x 10, 0.1 in center female header. Any 3M-type connector can be used as the interface to your system. The termination adaptor contains the passive network needed to properly terminate the logic analyzer's probes. It provides a 100 k $\Omega$ , 8 pF termination to your system.

If you want to have the termination closer to the active components on your board, you can use the 1810-1278 termination dip package to provide the logic analyzer's termination. The 18-pin dip package consists of 9 termination networks. Each IC is designed to provide a signal path for 8 data channels and a clock line.

### Oscilloscope Probes

Selecting the right probe for your particular measurement involves many choices. While the oscilloscope modules in each analyzer come with probes that meet most measurement needs, you may require a probe with other characteristics.

The HP 1652B/1653B are shipped with HP 10430A probes. The HP 16530A/16531A oscilloscopes are shipped with the HP 10433A mini-probes.

If you require more information on HP oscilloscope accessories, refer to "Oscilloscope Probes and Accessories" guide (HP part number 5954-2678). This guide includes information on probe selection, and lists other oscilloscope accessories.

### Capture Patterns with Your State Analyzer

The HP 10392A translates state analyzer data into pattern generator data. You can use the state-to-pattern generator link to help develop test vectors for simulation of missing boards or modules, functional verification, or regeneration of patterns captured at a remote site.

Functional test with the pattern generator and state analyzer is easier when you can obtain test vectors from a known good source. You can obtain test vectors from a number of sources, then merge them into the pattern generator to create just the test you need.

The HP 10392A state-to-pattern generator link software runs on the HP 16500A logic analysis system without the use of an external controller. This software lets you translate state analyzer data files from your HP 1650B/1651B/1652B/1653B/1654B or HP 16510B state analyzer to the HP 16520A/16521A pattern generator.

You can choose automatic or manual label generation and channel assignments, to best meet your test setup needs. Automatic translation of symbols from the state analyzer to the pattern generator makes data interpretation easier. When the state analyzer's time tagging feature is turned on, the pattern generator's clock rate is automatically set, and repeat statements are used to duplicate as closely as possible the data rates of your system.

### HP Testmobiles and Carrying Cases

Make your logic analysis system a portable one with the HP testmobile. Each testmobile is designed to withstand rugged use. Drawers for storing your accessories are included. The HP 1008A testmobile with option 006 is designed for the HP 16500A logic analysis system. The HP 1180A is designed for the HP 1650-series logic analyzers.

The 1540-1066 soft carrying case for the HP 1650-series logic analyzers allows you to easily carry your logic analyzer and its accessories to remote sites.

### Pattern Generator Output Drivers

The HP 10345A 8-channel ECL differential output driver pod translates the HP 16520A/16521A ECL signals into ECL differential output levels. The HP 10346A 8-channel TTL tristate buffer pod allows you to tristate groups of pattern generator channels. The HP 10346A is useful when you are driving bidirectional busses, such as backplane busses. The HP 10348A CMOS tristate buffer pod provides CMOS voltage levels and will allow you to tristate channels in the same manner as the HP 10346A.

For ordering information see page 292.

\* 3M is a registered trade mark of Minnesota Mining and Manufacturing Co.



### HP 10390A System Performance Analysis Software

#### Optimize Your System

See an overall picture of your system to find the routines that are slowing performance. The HP 10390A system performance analysis software (SPA) converts your HP logic state analyzer into a powerful tool for finding bottlenecks in your system. SPA can help you find the routines that are called most often, identify inefficient use of disks and peripherals, and find processes that use too much CPU time.

The state analyzer repetitively samples your target system as it operates. The analyzer takes a sample of your system, sorts the captured data into ranges, then delays a random amount of time before starting again. The random delay ensures that the measurement won't sync on only a small portion of your system's code. After each acquisition, the captured information is translated into histograms and bar charts to present the big picture of your system's operation.

SPA performs three kinds of measurements: state overview, state histogram, and time interval measurements.

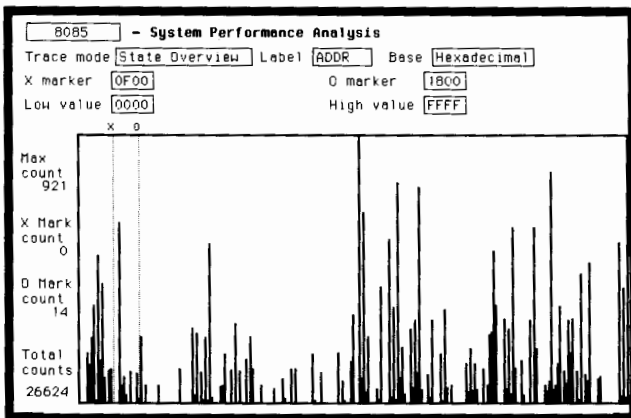

State overview mode on the address lines of microprocessor.

#### State Overview: a Macro View

The state overview measurement shows an overview of system activity. Set the state overview to look at address lines; the display shows how many times the process accesses each address. This measurement quickly tells you which addresses have activity and which addresses are never used. Use this as a coverage test for diagnostic software or to verify that there are no accesses to protected segments of memory.

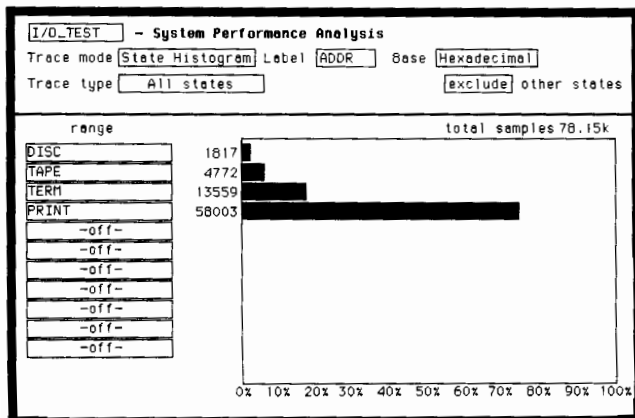

State histogram of system activity.

#### State Histogram: Software Usage

State histograms allow you to break your measurement into small ranges that correspond to the natural boundaries in your system. A trace shows you the percentage of all operations that occur in a specific range. How often does your system access a disk drive or a printer? Use the state histogram mode to characterize the peripheral usage to optimize your system.

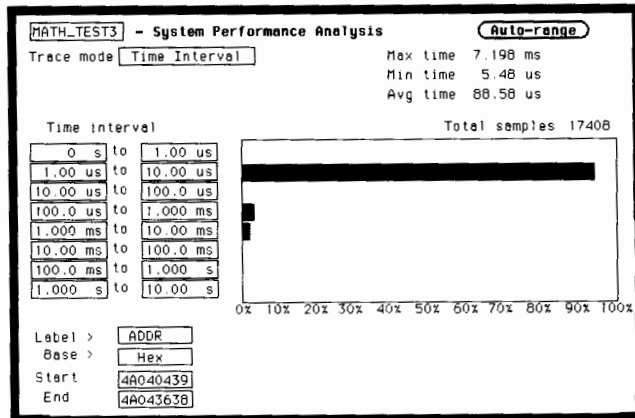

Time interval mode measures the time spent between two events in your system.

#### Time Interval: Real-Time Performance

When characterizing the speed of your software, use the time interval measurement. Time interval mode measures the time between two events in your system. Now you can find I/O routines that reduce system performance by spending too much time in wait loops, or you can identify error recovery procedures that sometimes take too long.

The time interval mode produces a histogram of time intervals, divided into as many as eight user-definable time ranges. In addition, the average, minimum, and maximum times captured between system events, plus the total number of time interval samples taken, can be read directly off the display.

#### Operating Characteristics

**State overview:** Bar chart of all possible values of a label versus number of occurrences of each value, available on any label setup in the state format specification. X-axis is all possible values for a label. (Example: for a label with 16 bits, the x-axis can go from 0 to FFFFH.)

**State histogram:** histogram of states that occur within specified values of a label. Available on any label setup in the state format specification. User may specify up to 11 ranges of values.

**Time interval:** histogram of the time intervals between user-specified start and stop events. 40 ns time resolution, 60 ns minimum sample period.

**Time interval size:** 10 ns to 999,000 seconds.

Calculated statistics: maximum time, minimum time, average time, total number of time intervals sampled. Start and stop can be qualified from another machine in the logic analyzer.

System performance analysis features are NOT programmable via HP-IB or RS-232.

# LOGIC ANALYZERS

## Specifications and Characteristics

HP 1650B, 1651B, 1652B, 1653B, 1654B, 16510B, 16511B

### Key State and Timing Specifications and Characteristics

Model	HP 1650B	HP 1651B	HP 1652B	HP 1653B	HP 1654B	HP 16510B	HP 16511B
Channel count	80	32	80	32	64	80	160
Maximum state input Clock rate *	35 MHz	25 MHz	35 MHz	25 MHz	35 MHz	35 MHz	35 MHz
Setup time *	10 ns	10 ns	10 ns	10 ns	10 ns	10 ns	10 ns
Hold time *	0 ns	0 ns	0 ns	0 ns	0 ns	0 ns	0 ns
Minimum state clock Pulse width *	10 ns	10 ns	10 ns	10 ns	10 ns	10 ns	10 ns
Number of state clocks/qualifiers	5	2	5	2	2	5	5
Memory depth per channel	1024	1024	1024	1024	1024	1024	1024
Sequence levels	8	8	8	8	8	8	8
Trigger width	80 ch	32 ch	80 ch	32 ch	64 ch	80 channels	160 channels
Minimum detectable glitch width * (at threshold)	5 ns	5 ns	5 ns	5 ns	5 ns	5 ns	5 ns
Input R	100 K $\Omega$ $\pm 2\%$	100 K $\Omega$ $\pm 2\%$	100 K $\Omega$ $\pm 2\%$	100 K $\Omega$ $\pm 2\%$	100 K $\Omega$ $\pm 2\%$	100 K $\Omega$ $\pm 2\%$	100 K $\Omega$ $\pm 2\%$
Input C	$\sim 8$ pF	$\sim 8$ pF	$\sim 8$ pF	$\sim 8$ pF	$\sim 8$ pF	$\sim 8$ pF	$\sim 8$ pF
Lead sets included	YES	YES	YES	YES	YES	YES	YES

\* = Specifications

### Additional Specifications and Characteristics

#### Probes

**Minimum input voltage swing:** 600 mV peak-to-peak<sup>1</sup>.

**Input threshold accuracy:**  $\pm 150$  mV accuracy over the range  $-2.0$  to  $2.0$  volts.  $\pm 300$  mV accuracy over the ranges  $-9.9$  to  $-2.1$  volts and  $2.1$  to  $9.9$  volts<sup>1</sup>.

**Input dynamic range:**  $\pm 10$  volts about the threshold<sup>1</sup>.

**Minimum input overdrive:** 250 mV or 30% of the input amplitude, whichever is greater.

**Maximum input voltage:**  $\pm 40$  volts peak.

**Threshold setting:** threshold levels may be defined for pods 1, 2 and 3 on an individual basis. One threshold can be defined for pods 4 and 5. When using the HP 16511B, each card has independent threshold levels as defined above.

**Threshold range:**  $-9.9$  to  $+9.9$  volts in 0.1 volt increments.

**Channel assignment:** each group of 16 channels (a pod) can be assigned to analyzer 1, analyzer 2 or remain unassigned.

#### State analysis

##### State clocking

**Maximum clock rate with time/event tagging on:** 16.67 MHz (60 ns).

**Master-slave clocking (mixed/demultiplexed clocking):** masterclock must follow slave clock by at least 10 ns and precede the next slave clock by at least 50 ns.

**Clocks:** HP 1650B, 1652B: 5 clocks

HP 1651B, 1653B: 2 clocks

HP 1654B: 4 clocks

Clock edges can be ORed together and operate in single phase, two phase demultiplexing, or two phase mixed mode. Clock edge is selectable as positive, negative, or both edges for each clock.

<sup>1</sup>Specifications.

**Clock qualifier:** the high or low level of the available clocks can be ANDed with the clock specification. Setup time: 20 ns; hold time: 5 ns.

**Pattern recognizers:** each recognizer is the AND combination of bit (0, 1, or X) patterns in each label. 8 pattern recognizers are available when one state analyzer is on. 4 are available to each analyzer when two state analyzers are on.

**16511B Clock probing:** while using the HP 16511B, and when more than 80 channels are assigned to Analyzer 1, each clock probed by pods on the first card must be probed by pods on the second card also.

**Range recognizer:** recognizes data which is numerically between or on two specified patterns (ANDed combination of zeros and/or ones). The maximum size is 32 bits.

**Qualifier:** a user-specified term that can be anystate, nostate, a single pattern recognizer, range recognizer, or logical combination of pattern and range recognizers.

**Branching:** each sequence level has a branching qualifier. When satisfied, the analyzer will restart the sequence or branch to another sequence level. Branching not allowed across sequence that contains the trigger.

**Occurrence counter:** sequence qualifier can be specified to occur up to 65535 times before advancing to the next level.

**Storage qualification:** each sequence level has a storage qualifier that specifies the states that are to be stored.

**Triggering:** user can specify a trigger word qualifier that can occur across any combination of channels, up to 160 (HP 16511B).

## Tagging

**State Tagging:** Counts the number of qualified states between each stored state. Measurement can be shown relative to the previous state or relative to trigger. Maximum count is  $4.4 \times 10^{12}$ .

**Time Tagging:** Measures the time between stored states, relative to either the previous state or to the trigger. Maximum time between states is 48 hrs. With tagging on, the acquisition memory depth is halved. Minimum time between states is 60 ns.

## Symbols

**Pattern symbols:** User can define a mnemonic for the specific bit pattern of a label. When data display is SYMBOL, mnemonic is displayed where the bit pattern occurs.

**Range symbols:** User can define a mnemonic covering a range of values. When data display is SYMBOL, values within the specified range are displayed as mnemonic + offset from base of range.

**Number of pattern and range symbols:** 100 per analyzer. Symbols can be downloaded over RS-232 or HP-IB.

## Timing analysis

**Transitional timing mode:** sample is stored in acquisition memory only when the data changes. A time tag stored with each sample allows reconstruction of waveform display. Time covered by a full memory acquisition varies with the number of pattern changes in the data.

**Sample period:** Every 10 ns.

**Maximum time covered by data:** 5000 seconds.

**Minimum time covered by data:** 10.24  $\mu$ s

**Glitch capture mode:** data sample and glitch information is stored every sample period.

**Sample period in glitch mode:** 20 ns to 50 ms in a 1-2-5 sequence, dependent on sec/div and delay settings. Sample period displayed when markers are off.

**Time covered by data in glitch mode:** sample period  $\times$  512.

## Timing waveform display

**Sec/div:** 10 ns to 100s; 0.01% resolution.

**Hardware delay:** 20 ns to 10 ms.

**Accumulate:** waveform display is not erased between successive acquisitions.

**Overlay mode:** Multiple channels can be displayed on one waveform display line. Primary use is to view summary of bus activity.

**Maximum number of displayed waveforms:** 24 lines

## Time interval accuracy

**Sample period accuracy:** 0.01% of sample period.

**Channel-to-channel skew:** 4 ns typical.

**Time interval accuracy:**  $\pm$  (sample period + channel-to-channel skew + 0.01% of time interval reading).

## Trigger specification

**Asynchronous pattern:** Trigger on an asynchronous pattern less than or greater than specified duration. Pattern is the logical AND of specified low, high, or don't care for each assigned channel. If pattern is valid but duration is invalid, there is a 20 ns reset time before looking for patterns again.

**Greater than duration:** Maximum duration is 40 ns to 10 ms with 10 ns or 0.01% resolution, whichever is greater. Pattern must be valid for at least 20 ns. Accuracy is +20 ns to -0 ns. Trigger occurs at the end of the pattern.

**Glitch/Edge Triggering:** Trigger on glitch or edge following valid duration of asynchronous pattern and while the pattern is still present. Edge can be specified as rising, falling, or either. Less than duration forces glitch and edge triggering off.

## Measurement and display functions

**Arming:** Each analyzer can be armed by the run key, the other analyzer, the intermodule bus (HP 16500A), or the built-in oscilloscope (HP 1652B/1653B).

**Trace mode:** Single mode acquires data once per trace specification; repetitive mode repeats single mode acquisitions until stop is pressed or until pattern time interval or compare stop criteria are complete.

**Labels:** Channels can be grouped together and given a 6-character name. Up to 20 labels in each analyzer can be assigned with up to 32 channels per label.

**Activity indicators:** provided in the configuration, state format, and timing format menus for monitoring device-under-test activity while setting up the analyzer.

**Markers:** two markers (X and O) are shown as dashed lines in the display.

**Trigger:** displayed as a vertical dashed line in the timing waveform, state waveform and X-Y chart displays and as line 0 in the state listing and state compare displays.

## Measurement functions

**Run:** starts acquisition of data in specified trace mode.

**Stop:** In single trace mode or the first run of a repetitive acquisition, the Stop function halts acquisition and displays the current acquisition data. For subsequent runs in repetitive mode, Stop halts acquisition of data and does not change current display.

**Time interval:** The X and O markers measure the time interval between events occurring on one or more waveforms or states (only available when time tagging is on).

**Delta states:** The X and O markers measure the number of tagged states between any two states.

**Patterns:** The X or O marker can be used to locate the nth occurrence of a specified pattern before or after trigger, or after the beginning of data. The O marker can also find the nth occurrence of a pattern before or after the X marker.

**Statistics:** X to O marker statistics are calculated for repetitive acquisitions. Patterns must be specified for both markers, and statistics are kept only when both patterns can be found in an acquisition. Statistics are minimum X to O time, maximum X to O time, average X to O time, and ratio of valid runs to total runs.

**Compare mode functions:** Performs post-processing bit-by-bit comparison of the acquired state data and compare image data.

**Compare image:** Created by copying a state acquisition into the compare image buffer. Allows editing of any bit in the compare image to a 1, 0 or X. Compare image can also be edited via HP-IB or RS-232.

**Compare image boundaries:** Each channel (column) in the compare image can be enabled or disabled with bit masks in the compare image. Upper and lower ranges of states (rows) in the compare image can be specified. Any data bits that do not fall within the enabled channels and the specified range are not compared.

**Compare Stop measurement:** Repetitive acquisitions can be halted when the comparison between the current state acquisition and the current compare image is equal or not equal.

**Compare Displays:** Compare listing shows the compare image and bit masks; difference listing highlights differences between the current state acquisition and the compare image.

## Data entry/display

**Display modes:** State listing, state waveforms, state chart, state compare listing, compare difference listing, timing waveforms, interleaved time-correlated listing of two state analyzers (time tagging on), time-correlated state listing and timing waveform on the same display; oscilloscope displays (HP 1652B/1653B only): oscilloscope waveform, time-correlated timing with oscilloscope, time-correlated state listing and timing waveform with oscilloscope waveform.

**State X-Y chart display:** Plots value of a specified label (on y-axis) versus states or another label (on x-axis). Both axes can be scaled.

**Markers:** Correlated to state listing, state compare, and state waveform displays. Available as pattern, time, or statistics (with time counting) and states (with state counting on).

**Accumulate:** Chart display is not erased between successive acquisitions.

**State waveform display:** displays state acquisitions in waveform format.

**States/division:** 1 to 104 states

**Delay:** - 1023 to + 1024 states

**Accumulate:** waveform display is not erased between successive acquisitions.

**Overlay mode:** Multiple channels can be displayed on one waveform display line. Primary use is to view summary of bus activity.

**Maximum number of displayed waveforms:** 24.

**Markers:** Correlated to the state listing, state compare, and X-Y chart displays.

**Timing waveform:** Pattern readout of timing waveforms at X or O marker.

**Bases:** Binary, octal, decimal, hexadecimal, ASCII (display only), user-defined symbols

# LOGIC ANALYZERS

## Specifications and Characteristics

HP 1652B, 1653B

### Key Oscilloscope Specifications and Characteristics

Model(s)	HP 1652B, HP 1653B
Type	2 channel simultaneous acquisition
Bandwidth (-3dB) *	dc to 100 MHz (single shot)
Maximum sample rate	400 MSa/s
Transition time (10% - 90%)	≤ 3.5 ns
A/D	6 bit real-time
A/D resolution	±1.6% of full scale
Waveform record length	2048 points
Time interval measurement accuracy *	±(2% x s/div + .01% x delta t + 500 ps)
dc gain accuracy *	± 3% of full scale
dc offset accuracy *	± (2 mV + 2% of channel offset + 2.5% of full scale)
Voltage measurement accuracy *	Gain accuracy + offset accuracy + ADC resolution
Trigger	Either/both input channels, rising or falling edge(s)
Armed by	run, external BNC low input, or analyzer 1 or 2
Trigger sensitivity *	10% of full screen
Input coupling	dc
Input R	1 MΩ ± 1% or 50 Ω ± 1%
Input C	Approximately 7 pF
Probes included	2 - HP 10430A 10:1, 1 MΩ, 6.5 pF, 1m mini-probes

\* = Specifications (valid within ± 10° C of software calibration temperature).

### Supplemental Characteristics

#### Vertical (at BNC)

**Vertical sensitivity range:** 15 mV/div to 10 V/div (1:1 probe)

**Vertical sensitivity resolution:** Adjustable 2 digit resolution

**dc offset range:** ± 2.0 V for ≤ 50 mV/div

**(1:1 probe)** ± 10 V for 100 mV/div and 200 mV/div

± 50 V for 500 mV/div and 1 V/div

± 125 V for ≥ 2 V/div

± 5 V max if input impedance at 50 ohm.

**dc offset resolution:** 200 μV for ≤ 50 mV/div

**(1:1 probe)** 1 mV for 100 mV/div and 200 mV/div

5 mV for 500 mV/div and 1 V/div

25 mV for ≥ 2 V/div

or 4 digits of resolution, which ever is greater.

**Probe factors:** Any integer ratio from 1:1 to 1000:1.

**Maximum safe input voltage:** 1 MΩ: ± 250 V [dc + peak ac (<10kHz)]; 50 Ω: 5 V rms.

**Channel isolation:** 40 dB: dc to 50 MHz; 30 dB: 50 MHz to 100 MHz (with channels at equal sensitivity).

#### Horizontal

**Timebase range:** 5 ns/div to 5 s/div

**Timebase resolution:** for t < 10 ns/div, 100 ps resolution; for t ≥ 10 ns/div, adjustable with 3-digit resolution

#### Delay Pretrigger Range:

Time/division Setting Available Delay

5 ns - 500 ns 2.5 μs

500 ns - 5s 5 x (s/div)

5 ns - 50 μs/div 10,000x (s/div)

### Triggering

**Trigger level range:** dc offset ± 6 divisions

**Trigger level resolution:** 400 μV for ≤ 50 mV/div (1:1 probe)  
2 mV for 100 mV/div and 200 mV/div  
10 mV for 500 mV/div and 1 V/div  
50 mV for ≥ 2 V/div

### Trigger mode descriptions

**Immediate:** Triggers immediately after arming condition is met.

**Edge:** Triggers on rising or falling edge from channel 1 or 2.

**Auto Trigger:** Self triggers if no trigger condition is found within approximately 1 second after arming.

**Trigger Out:** Arms Analyzer 1 or 2 or triggers the rear panel BNC.

### Waveform display

**Display formats:** 1 to 8 scope waveforms displayed.

**Display resolution:** 500 points horizontal, 240 points vertical.

### Display modes

**Single:** new acquisition replaces old.

**Accumulate:** new acquisition displayed in addition to previous acquisitions until screen is erased.

**Average:** New acquisitions are averaged with old acquisitions and displayed. Maximum number of averages 256.

**Overlay:** Channel 1 and Channel 2 can be overlaid in the same area.

**Connect-the-dots:** Sampled data values connected by straight lines.

**Waveform reconstruction:** A reconstruction filter fills in missing data points for timebase ≤ 100 ns/div.

**Waveform math:** Display capability of A-B and A+B functions.

**Mixed mode:** Scope plus logic analyzer displays on same screen.

### Measurement aids

**Time markers:** Two vertical markers labeled X and O. Voltage levels displayed for each marker. Time interval measurements can be made between any two events.

**Automatic search:** Searches for a specified absolute or percentage voltage level at a positive or negative edge, count adjustable from 1 to 1024.

**Auto Search Statistics:** Mean, maximum, and minimum values for elapsed time from X to O markers for multiple runs. Number of valid runs and total number of runs displayed.

**Trigger level marker:** Horizontal trigger level marker displayed in Trace/Trigger menu only.

**Automatic measurements:** Automatic measurement of: + pulse width, - pulse width, frequency, period, risetime, falltime, V p-p, preshoot, overshoot.

**Grid:** Selectable (on/off).

### Setup aids

**Autoscale:** Auto scales the vertical and horizontal ranges, offset, and trigger levels to best display input signals. Requires amplitude above 10 mV peak, and frequency between 50 Hz and 100 MHz.

**Preset:** Scales the vertical range, offset, and trigger level to best display TTL and ECL waveforms.

**Calibration:** vertical, trigger, channel 1 to channel 2 deskewing, delay, and all defaults.

**Probe compensation source:** External BNC supplies square wave approx. -400 mV to -900 mV at approximately 1.25 KHz.

### Interactive measurements

**Acquisition:** Analog, timing, and state can occur simultaneously or in series.

**Mixed displays:** Timing channels and analog channels can be displayed on the same screen. State listings with time tags, timing channels and analog channels can be displayed on the same screen.

**Time correlation:** All modules are time correlated.

### Time interval accuracy

**Between modules:** Equals the sum of channel to channel time interval accuracies of each machine used for a measurement.

### Key Characteristics

Model	HP 16515A, HP16516A
Sample rate	1 ns to 1.6 ms
Number of channels	16 per HP 16515A or 16516A
Memory depth per channel	8192
Input R	10 K $\Omega$ $\pm$ 2%
Input C	Approximately 3 pF
Leads sets included	YES

### Specifications

**Minimum input voltage swing:** 500 mV peak-to-peak  
**Input threshold accuracy:**  $\pm$  150 mV  $\pm$  3.0% from 0 to +5 volts;  $\pm$  150 mV  $\pm$  2.0% from -3.5 volts to 0 volts  
**Input dynamic range:**  $\pm$  7.0 volts

### Supplemental Characteristics

#### Probes

**Minimum input overdrive:** 250 mV or 30% of the input amplitude, whichever is greater, above the pod threshold  
**Maximum input voltage:**  $\pm$  40 volts  
**Threshold range:** -3.5 to +5.0 volts in 0.1 volt increments

#### Time interval accuracy\*

**Time interval accuracy:**  $\pm$  (sample period + .01% of time interval reading + table value below)

Sample rate	Within 1 Pod	Across Pods
1 Gsa/s	1 ns	1.5 ns

#### Trigger\*

**Asynchronous pattern:** Trigger on asynchronous pattern less than or greater than specified duration, or trigger on not-equal to pattern greater than the specified duration. If pattern is valid but duration is invalid, there is a 2.6 ns reset time before the instrument is ready to look for the pattern again.

**Greater than duration:** Trigger occurs at pattern valid followed by duration expired.

**Greater than duration range:** 2 ns to 507 sample periods for patterns specified within a pod. 7 ns to 507 sample periods for patterns specified across pods on the same board. 10 ns to 507 sample periods for patterns specified across boards within a module (1 each 16515A/16516A).

**Greater than duration resolution:** 4 sample periods.

\* These characteristics are true for input signal,  $V_H = -0.90$  V,  $V_L = -1.70$  V, threshold = -1.3V, slew rate = 1 V/ns.

**Greater than duration accuracy:**  $\pm$  2 ns for 2 ns setting. For all other settings:  $\pm$  1 sample period  $\pm$ : 2 ns for patterns specified within a pod; 6 ns for patterns specified across pods on the same board; 8 ns for patterns specified across boards.

**Less than duration:** Trigger occurs at the end of the pattern. Patterns specified within a pod must be valid for at least 2.0 ns. Patterns specified across pods on the same board must be valid for at least 11 ns. Patterns may not be specified across boards.

**Less than duration range:** 16 ns to 507 sample periods for patterns specified within a pod. 20 ns to 507 sample periods for patterns specified across pods on the same board.

**Less than duration resolution:** 4 sample periods.

**Less than duration accuracy:**  $\pm$  1 sample period  $\pm$ : 3 ns for patterns specified within a pod; 7 ns for patterns specified across pods.

**Edge trigger:** Trigger on edge following valid duration of asynchronous pattern. Less than duration forces edge triggering off. Minimum pulse width 1.5 ns.

**Delay from trigger to port-out BNC:** Less than 50 ns from the probe tip.

**Arming:** By the run key, or from any other module or the external port-in via the intermodule bus.

#### Display functions

**Data display/entry labels:** Channels may be grouped together and given a 6 character name. Up to 20 labels may be assigned with up to 32 channels per label.

**Bases:** Binary, octal, decimal, hexadecimal, ASCII (display only), user-defined symbols.

**Timing waveform:** interleaved, time-correlated listing of timing waveforms and waveforms from other measurement modules (i.e. another timing analyzer or oscilloscope).

**Waveform display:** sec/div adjustable from 1 ns to 1 s, with 3-digit resolution.

**Delay:** -12.5 s to 53.5 ks

**Accumulate:** Waveform display is not erased between successive acquisitions.

**Overlay mode:** Multiple channels can be displayed on one waveform display line. Primary use is to view summary of bus activity.

**Displayed waveforms:** 24 maximum.

**Symbols:** 100 maximum.

#### Marker functions

**Time interval:** The X and O markers measure the time interval between events occurring on one or more waveforms.

**Patterns:** The X or O markers can be used to locate the 0 to 8192 occurrence of a specified pattern.

# LOGIC ANALYZERS

## Specifications and Characteristics

### HP 16520A, 16521A

#### Characteristics

Model	HP 16520A Master	HP 16521A Expansion
Number of channels	12	48
Bits per channel	4095	4095
Maximum bit rate	50 MBit/s NRZ	50 MBit/s NRZ
Number of return-to-zero channels	3	0
Output voltages	TTL, ECL	TTL, ECL
Lead sets included	YES	NO

#### Specifications

**Internal clock period accuracy:**  $\pm 2\%$  of period  $\pm 1$  ns

**External clock duty cycle:** 10 ns minimum high time, 10 ns minimum low time.

#### Supplemental Characteristics

##### Clock sources (16520A only)

**Internal clock period:** 20 ns to 200  $\mu$ s in a 1-2-5 sequence

**External clock period:** 1 Hz to 50 MHz. Internal frequency divide (/1, /5, or /10) provided.

##### Return-to-zero (RZ) channels (16520A only)

**Number of RZ channels:** 3

**Bits/channel:** 4095

**Maximum bit rate:** 20 MBit/s (50 ns Period)

**Edge placement:** > 100 ns period: tenths of period; 50 ns to 100 ns Period: fifths of period; where delay + width  $\leq$  period.

**Minimum delay:** 0

**Minimum width:** 1/10 data period for > 50 ns period; 1/5 of data period for 50 ns data period

**Data rate with external clock:** User can divide data rate by 1/5 or 1/10 the external clock rate.

#### Output Characteristics

Eight-channel pods can be assigned as either standard ECL or TTL levels. All characteristics are valid at the the probe tip.

##### Output Levels

	ECL	TTL
Voh (steady state)	-0.98 V	2.7 V
Vol (steady state)	-1.55 V (into 10 K $\Omega$ , 10 pF)	0.6 V (into 10 K $\Omega$ , 10 pF)
Risetime/ falltime (typ)	2.3 ns (-0.98 V to -1.55 V)	2.5 ns (0.6 V to 2.7 V)
Skew* (same card)	$\leq 5$ ns	$\leq 5$ ns
Skew* (card-to-card)	< 10 ns	< 10 ns
Number of standard loads	3 (10 KH ECL, leaving Vnh=150 mV)	3 (LS, @ Vnl=250 mV)
Look-back impedance	50 $\Omega$	50 $\Omega$

(output measurements made into a load consisting of 10 K $\Omega$  in series shunted with 10 pF to ground.)

(\*) Skew measured at (+1.6 V) TTL and (-1.3 V) ECL levels.

#### Additional Output Options

**TTL and CMOS tristate:** via buffer pods. User must supply 5 V power and tristate signal.

**Differential ECL:** via ECL differential pods. User must supply -5 V power.

#### Clock/input probe

**Maximum input voltage:**  $\pm 40$  V

**Input impedance:** 100 K $\Omega$ , 8 pF

**External clock-in to clock-out delay:** Approximately 50 ns

#### Clock/Input Probe Threshold Levels

	ECL	TTL
Vih (min)	-1.00 V	2.08 V
Vil (max)	-1.52 V	1.12 V

#### Editing functions

**Program listing:** delete, merge, copy, insert.

**Data display formats:** binary, octal, decimal, hex, and symbol.

**Symbols:** 100 maximum.

**Step mode:** single-step program execution in 1 to 999 program line steps, from a break.

#### Data instruction set

**Break:** Stops program execution, last data vector is held at output

**Repeat:** Repeats vector up to 256 times.

**Wait IMB:** Wait for inter-modular trigger.

**Wait External:** Wait for user-defined 3-bit pattern on external input pod to become true. Pattern must be valid during time period -30 ns to 0 ns before next Clock edge. Latency between valid pattern and next state can occur.

**Signal IMB:** arms other measurement modules.

**Macro:** Four Macros can be defined and inserted. Macros can be named using a 6-character label. Macros can contain any data instruction.

### Key Specifications and Characteristics

Model	HP 16530A, HP 16531A
Type	HP 16530A: time base card; supports up to 8 channels of simultaneous acquisition HP 16531A: 2 channel acquisition card
Bandwidth (-3dB) *	dc to 100 MHz (single shot)
Maximum sample rate	400 MSa/s
Transition time (10% - 90%)	≤ 3.5 ns
A/D	6 bit real-time
A/D resolution	± 1.6% of full scale
Waveform record depth	4096 points
Time interval measurement accuracy *	± .75 ns ± .2% of time base range ± .02% of reading (@ 2.5 ns sample period) or ± .2% of time base range ± .02% of reading (all other sample periods)
dc gain accuracy *	± 3% of full scale
dc Offset Accuracy *	± (1 of offset + 3% of full scale)
Voltage measurement accuracy *	Gain accuracy + offset accuracy + ADC resolution
Trigger	16530A: external trigger input 16531A: either/both input channels rising or falling edge(s), pattern trigger
Armed by	run, IMB, external trigger input
Trigger sensitivity * (dc - 100 MHz)	16530A: ≤ 20 mV 16531A: ≤ 12% of full scale
Input coupling	dc
Input R	1 MΩ ± 2% 50 Ω ± 3%
Input C	Approx. 13 pF
Probes Included	2- HP 10433A 10:1, 10 MΩ, 10 pF, 2m mini-probe

\* = Specifications (valid within ± 10 °C of auto-calibration temperature).

### Supplemental Characteristics

#### Vertical (at BNC)

**Vertical sensitivity range:** 5 mV/div to 2 V/div (1:1 probe).

**Vertical sensitivity resolution:** Adjustable with 2-digit resolution.

**DC offset range:** ±800 mV for < 800 mV/div  
± 16 V for ≥ 800 mV/div

**dc offset resolution:** 1 mV for < 800 mV/div  
20 mV for ≥ 800 mV/div

**Probe factors:** any integer ratio from 1:1 to 1:1000.

**Maximum safe input Voltage:** 1 MΩ input, ± 40 V (dc + peak ac), 50 Ω input, ± 5 V (dc + peak ac).

#### Horizontal

**Time base range:** 5 ns/div to 10 s/div.

**Time base resolution:** Adjustable with 3-digit resolution.

**Delay pre-trigger range:** 4096 x sample period.

**Delay post-trigger range:** 500 screen diameters.

### Triggering

**Internal trigger level range:** within display window (full scale and offset).

**Internal trigger level resolution:** 1% of full scale.

**External trigger level range:** ± 2 V.

**External trigger level resolution:** 2 mV.

**Maximum safe input voltage:** 1 MΩ input: ± 40 V (dc + peak ac);

**50 Ω input:** ± 5 V (dc + peak ac).

### Trigger mode descriptions

**Immediate:** Triggers immediately after arming condition is met.

**Edge:** Triggers on rising or falling edge of any internal channel or external trigger, count adjustable from 1 to 32,000.

**Pattern:** Triggers on entering or exiting a specified pattern of all internal channels and external trigger, count adjustable from 1 to 32,000.

**Auto-trigger:** Self triggers if no trigger condition is found within approximately 25 ms after arming.

**Events delay:** The trigger can be set to occur on the nth edge or pattern, as specified by the user. The number of events (n) can be set from 1 to 32,000 events.

**Trigger out:** Arms another measurement module or triggers the rear-panel BNC.

### Waveform display

**Display formats:** 1 to 8 waveforms can be displayed.

**Display resolution:** 500 points horizontal, 240 points vertical.

### Display modes

**Single:** new acquisition replaces old

**Accumulate:** New acquisitions are displayed in addition to previous acquisitions until screen is erased.

**Average:** New acquisitions are averaged with old acquisitions and displayed.

**Overlay:** Up to 8 acquired waveforms can be overlaid in the same display area.

**Connect-the-dots:** Provides a display of the sample points connected by straight lines.

**Waveform Reconstruction:** A reconstruction filter fills in the missing data points when sampling at 400 MSa/s.

**Waveform math:** Display capability of A-B and A+B functions is provided.

### Measurement aids

**Time markers:** Two vertical markers labeled X and O. Voltage levels are displayed for each marker. Time interval measurements can be made between any two events.

**Automatic search:** Searches for specified absolute or percentage voltage level at positive or negative edge, count adjustable from 1 to 1024.

**Automatic search statistics:** Mean, maximum, minimum value for elapsed time from X to O markers for multiple runs. Number of valid runs and total number of runs displayed.

**Automatic measurements:** Automatic measurement of: + pulse width, - pulse width, frequency, period, risetime, falltime, V p-p, V top-base, preshoot, overshoot.

**Grid:** Selectable (on/off).

### Setup aids

**Autoscale:** Auto scales the vertical and horizontal ranges, offset, and trigger level to best display the input signals. Requires an amplitude above 10 mV peak, and a frequency between 50 Hz and 100 MHz.

**Preset:** Scales the vertical range, offset, and trigger level to best display ECL or TTL waveforms.

**Calibration:** vertical, trigger, channel 1 to channel 2 deskewing, delay and all defaults. Cal factors stored to disk.

**Probe compensation source:** External BNC (on HP 16530A) supplies a square wave; approximately -400 mV to -900 mV at approximately 1 kHz.

# LOGIC ANALYZERS

## General Characteristics

HP 1650B, 1651B, 1652B, 1653B, 1654B, 16500A

### Characteristics

#### Disk Drives/Files

**Built-in disk drives file types:** system software, configuration (contains instrument configuration, data, pointer to inverse assembler file), inverse assembler, auto-configuration.

**Autoload designation:** a pre-defined configuration file can be loaded at powerup.

**Disk operations:** store, load, copy, duplicate disk, pack disk, rename, purge, format Disk.

#### Programmability/IO Ports

Instrument settings and operating modes can be remotely programmed for ALL logic analyzer models with either RS-232C or HP-IB (IEEE-488). Both ports are standard on all analyzers. Either port can be used for hardcopy output.

#### Hard-copy Output

**Printers supported:** HP ThinkJet, HP QuietJet, HP LaserJet series, HP PaintJet, HP DeskJet, Epson and Epson-compatible (e.g., Epson RX-80, RX-100, MX-80, MX-100) printers via RS-232C or HP-IB.

**HP-IB interface functions:** SH1, AH1, T5, TE0, L3, LE0, SR1, RL1, PP1, DC1, DT1, C0 and E2.

#### RS-232C configurations

**Protocols:** XON/XOFF, ENQ/ACK, none, data

**Bits:** 8

**Stop Bits:** 1, 1½, 2

**Parity:** none, odd, even

**Baud Rates:** 110, 300, 600, 1200, 4800, 9600, 19200.

#### Input/output Rear-panel BNCs

**Input BNC:** Labeled port-in (HP 16500A) or external trigger input (HP 1650B/1651B/1652B/1653B/1654B). Input signal must drive two LS TTL loads.

**Output BNC:** Labeled Port-out (HP 16500A) or External Trigger Output (HP 1650B/1651B/1652B/1653B/1654B). Output signal is active high, TTL output level, high > 2 V into 50 ohms, < 0.4 V into 50 ohms.

**Auxiliary power available through cables:** The HP 1650B/1651B/1652B/1653B/1654B/16510B provide power through the state/timing cables. Each cable is capable of providing 2/3 amp @ 5 V, to a maximum of 2 amp @ 5 V per analyzer or card. The HP 16500A logic analysis mainframe can provide 16.3 amp - current draw of installed cards @ 5 V. The primary use of the auxiliary power is as a source for preprocessors.

**Current draw per card:** 3.0 amp per HP 16510B, 1.3 amp per HP 16515A, 1.4 amp per HP 16516A, .7 amp per HP 16520A, .8 amp per HP 16521A, .4 amp per HP 16530A, 1.1 amp per HP 16531A.

### HP 16500A InterModule Bus (IMB)

**Run control:** Analog, timing, state, and pattern generation can be armed by group run. Modules can run concurrently or be armed in series. Each module can arm one or more modules.

**Mixed display modes:** Any timing or oscilloscope waveform displays can be mixed. State listings can be included with waveforms in the state/timing Mixed Mode display.

**Acquiring data for mixed displays:** To obtain a mixed display, multiple modules must be armed through the IMB. To include a state listing(s) in mixed mode display, state time tagging must be on.

**Time interval accuracy between modules:** Equals the sum of the channel-to-channel time interval accuracies of each module used in the measurement, for a deskewed measurement.

### Operating Environment

**Temperature:** Instrument, 0° to 50°C (+32° to 122°F). Disk media, 10° to 40°C (+50° to 104°F). Probes and cables, 0° to 65°C (+32° to 149°F).

**Humidity:** Instrument, up to 95% relative humidity at +40°C (+104°F). Disk media, 8% to 80% relative humidity.

**Altitude:** to 4600 m (15 000 ft)

**Vibration-operating:** random vibration 5-500 Hz, 10 minutes per axis, ~ 0.3 g (rms)

**Vibration-non-operating:** random vibration 5-500 Hz, 10 minutes per axis, ~ 2.41 g (rms); and swept sine resonant search, 5-500 Hz, 0.75 g (0-peak), 5 minute resonant dwell @ 4 resonances per axis.

### Weight

**HP 1650B/1651B/1654B:** net, 10.0kg (22lb); shipping 18.2kg (40lb).

**HP 1652B/1653B:** net, 11.0kg (24lb); shipping 19.0kg (42lb) shipping

**HP 16500A (max):** net, 18.1kg (40lb) + (.7kg (1.6lb) \* number of cards); shipping 25.9kg (57lb) + (3.6kg (8lb) \* number of cards)

### Power

**HP 1650B/1651B/1652B/1653B/1654B:** 115V/230 V, 48-66 Hz, 200 W max

**HP 16500A:** 115V/230 V, 48-66 Hz, 475 W max

### Size

**HP 1650B/1651B/1652B/1653B/1654B:** 194.3H x 425.4W x 355.6mmD (7.65" x 16.62" x 14.0") including rear feet, excluding bottom feet

**HP 16500A:** 222.2H x 425.7W x 548.6mmD (8.75" x 16.76" x 21.6"), including rear feet, excluding bottom feet



### State Analyzers: Key State and Timing Specifications and Characteristics

Model	HP 16540A master card HP 16541A expansion card								
Channel count	HP 16540A: 16 HP 16541A: 48								
Maximum state input Clock rate*	100 MHz								
Internal clock rate Range	10 ms - 100 MHz								
Setup/Hold Time*	Adjustable with 3 settings: <table style="margin-left: 20px;"> <tr> <td>T<sub>s</sub></td> <td>T<sub>h</sub></td> </tr> <tr> <td>4 ns</td> <td>0 ns</td> </tr> <tr> <td>2 ns</td> <td>2 ns</td> </tr> <tr> <td>0 ns</td> <td>4 ns</td> </tr> </table>	T <sub>s</sub>	T <sub>h</sub>	4 ns	0 ns	2 ns	2 ns	0 ns	4 ns
T <sub>s</sub>	T <sub>h</sub>								
4 ns	0 ns								
2 ns	2 ns								
0 ns	4 ns								
Minimum state clock Pulse width	3 ns								
Time and state tagging	To 100 MHz								
Memory depth per channel	4096								
Sequence levels	4								
Trigger width	Pattern recognition: full width of analyzer								
Input R	100 K $\Omega$ $\pm$ 2%								
Input C	$\sim$ 8 pF								
Lead sets included	YES								

\* = Specification

### Additional Characteristics

#### Probes

**Minimum input voltage swing:** 500 mV peak-to-peak.  
**Input threshold accuracy:**  $\pm$  100 mV  $\pm$  2% of setting.  
**Input dynamic range:**  $\pm$  10 volts above the threshold.

#### State clocking

**Master-slave clocking (mixed/demultiplexed clocking):**  
 Master clock must follow slave clock by at least 10 ns, and precede the next slave clock by at least 1 ns.

### Supplemental Characteristics

#### Probes

**Minimum input overdrive:** 250 mV or 30% of the input amplitude, whichever is greater.

**Maximum input voltage:**  $\pm$  40 volts peak.

**Threshold setting:** Threshold levels can be defined for each pod on an individual basis. One threshold can be defined for the clocks and qualifiers on each board.

**Threshold range:**  $-3.5$  to  $+5.0$  volts, in 0.1 volt increments.

#### Clocks

**Clocks:** Two master clocks are available on the HP 16540A. They can clock data for all data channels. Two slave clocks are available on each HP 16541A.

The HP 16541A clocks can clock data on its data channels only. Data can be latched on the positive, negative, or both edges for any clock.

**Clock qualifiers:** The HP 16540A has one global clock qualifier that can qualify data for all data channels. The HP 16541A has one local clock qualifier that can qualify data on its channels only. The high- or low-level of the clock qualifiers can be ANDed with the clock specification. Setup time: 5 ns. Hold time: 1 ns.

#### Triggering

**Pattern recognizers:** Each recognizer is the AND combination of bit (0,1, or X) patterns in each label. Four pattern recognizers are available.

**Range recognizer:** Recognizes data which is numerically between or on two specified patterns (ANDed combination of zeros and/or ones). The maximum size is 32 bits, assigned to the lowest bits of a 16541A.

**Qualifier:** A user-specified term that can be anystate, nostate, a single pattern recognizer, range recognizer, or logical combination of pattern and range recognizers.

**Branching:** Each sequence level has a branching qualifier. When satisfied, the analyzer will restart the sequence or branch to another sequence level.

**Occurrence counter:** Sequence qualifier can be specified to occur up to 65535 times before advancing to the next level.

**Storage qualification:** Each sequence level has a storage qualifier that specifies the states that are to be stored.

**Triggering:** Trigger is the last level of a 5 level sequence. Each level before trigger has an occurrence counter, store qualifier, and a state tagging qualifier. Each level before trigger can also branch to a previous level. The trigger level has a store qualifier.

#### Tagging

**State Tagging** counts the number of qualified states between each stored state. Measurement can be shown relative to the previous state or relative to trigger. Maximum count is 32 bits.

**Time tagging** measures the time between stored states, relative to either the previous state or the trigger with 10ns resolution. Maximum time between states is 43 seconds.

#### Measurement functions

**Run** starts acquisition of data in specified trace mode.

**Stop:** In single trace mode or the first run of a repetitive acquisition, the Stop function halts acquisition and displays the current acquisition data. For subsequent runs in repetitive mode, the Stop function halts acquisition of data and does not change current display.

**Arm:** The analyzer can be armed by the Run key or the Intermodule Bus.

**Single trace mode** acquires data once per trace specification.

**Repetitive trace mode** repeats single-mode acquisitions until STOP, or until pattern time interval or compare stop criteria are met.

**Labels:** Channels can be grouped together and given a 6-character name. Up to 20 labels in each analyzer can be assigned with up to 32 channels per label.

**Activity indicators** are provided in the Configuration and Format menus for monitoring device-under-test activity while setting up the analyzer.

**Markers:** X and O markers are shown as dashed lines in displays.

**Trigger:** Vertical dashed line in the Waveform and X-Y Chart displays; line 0 in the State Listing and State Compare displays.

**Time Interval:** X and O markers measure the time interval between events occurring on one or more waveforms or states (with time tagging on) Delta States: The X and O markers measure the number of tagged states between any two states (with State Tagging on).

**Patterns:** The X or O marker can be used to locate the nth occurrence of a specified pattern before or after trigger, after the beginning of data, or after another marker.

**Statistics:** X to O marker statistics are calculated for repetitive acquisitions. Patterns must be specified for both markers, and statistics are kept only when both patterns can be found in an acquisition. Statistics are minimum X to O time, maximum X to O time, average X to O time, and ratio of valid runs to total runs.

**Compare mode** performs post-processing bit-by-bit comparison of the acquired state data and Compare Image data.

**Compare image** is created by copying a state acquisition into the compare image buffer. Allows editing of any bit in the Compare Image to a 1, 0 or X. Compare Image can be edited via HP-IB or RS-232.

**Compare image boundaries:** Each channel (column) in the Compare Image can be enabled or disabled via bit masks in the Compare Image. Upper and lower ranges of states (rows) in the Compare Image can be specified. Any data bits that do not fall within the enabled channels and the specified range are not compared.

**Stop measurement:** Repetitive acquisitions can be halted when the comparison between the current state acquisition and the current Compare Image is equal or not equal.

**Displays:** The Compare Listing display shows the Compare Image and bit masks. The Difference Listing display highlights differences between the current state acquisition and the Compare Image.

#### Data Entry/Display

**Display Modes:** Listing, Waveforms, Chart, Compare Listing, Compare Difference Listing, or Listing with oscilloscope waveforms. X-Y Chart Display: Plots value of a specified label (on y-axis) versus states or another label (on x-axis). Both axes can be scaled.

**Markers:** Correlated to Listing, Compare and Waveform displays. Available as pattern, time, or statistics (with time counting) and states (with state counting on).

**Accumulate:** Chart display is not erased between successive acquisitions.

**Waveform display** shows acquisitions in waveform format.

States/division (state mode): 1 to 104 states.

Sec/div (internal clock mode): 10 ns to 100 s; 0.01% resolution.

Delay: - 4096 to + 4096 states.

**Accumulate:** Waveform display is not erased between successive acquisitions.

**Overlay mode:** Multiple channels can be displayed on one waveform display line. Primary use is to view summary of bus activity.

**Displayed Waveforms:** 24 maximum.

**Markers:** Correlated to the state listing, state compare, and X-Y chart displays.

**Pattern Waveform:** readout of waveform label values at X or O marker.

**Bases:** Binary, Octal, Decimal, Hexadecimal, ASCII (display only), user-defined symbols.

#### Symbols

**Pattern symbols:** User can define a mnemonic for the specific bit pattern of a label. When data display is SYMBOL, mnemonic is displayed where the bit pattern occurs.

**Range symbols:** User can define a mnemonic covering a range of values. When data display is SYMBOL, values within the specified range are displayed as mnemonic + offset from base of range.

**Number of Pattern and Range Symbols:** 100 per module. Symbols can be downloaded over RS-232 or HP-IB.

### Logic Analyzer Upgrade Kits

Upgrade kits for logic analyzers include software, hardware, or both, to enhance the performance of your logic analyzer. The text below summarizes the upgrade options available for the HP logic analyzers listed. See page 292 for prices.

#### HP 1650A and 1651A Upgrades

You can upgrade the software capabilities of your HP 1650A or HP 1651A logic analyzer with the HP 10449A software upgrade kit. This kit includes RAM, ROM, software, and manual inserts to add the following features to the HP 1650A or HP 1651A:

- state compare mode
- state waveforms
- state chart mode

The HP 10449A upgrade kit does NOT include the HP-IB interface or 35 MHz state analysis features present on the HP 1650B. HP Service Center installation is highly recommended and is not included in the price.

#### HP 16510A Upgrade

The 16510-68703 adds the following software features to your HP 16510A logic analyzer:

- state compare mode
- state waveforms
- state chart mode

This upgrade kit contains software only, and you can install it yourself. The software in this kit is compatible with all HP 16500A modules.

#### HP 16500A Frame Upgrades

The 16500-68704 CPU board allows you to upgrade your frame to 2.5 M bytes of operating system memory. This kit is suggested for customers who own frames shipped before January 1990, who are using 4 or more measurement modules. Frames purchased after January 1990 offer 2.5 M bytes of operating system memory standard.

#### HP 16510A-to-HP 16510B Upgrade

The HP 10448A 35 MHz state hardware upgrade kit for the HP 16510A logic analyzer provides an upgrade to 35 MHz state analysis as well as state compare, state waveforms, and state chart mode. This kit includes the following:

- 80-channel 35 MHz state/100 MHz timing card with no probe assemblies (requires transfer of probe assemblies from the HP 16510A to the new HP 16510B 35 MHz state card)
- software for the new card
- manual inserts

You can install this upgrade kit yourself. It is compatible with all HP 16500A modules. The new card also includes connectors to allow installation of the HP 16511B 160-channel 35 MHz state/100 MHz timing conversion kit. See page 272 for a description of the HP 16511B logic analyzer.

#### HP 1650B to HP 1652B and HP 1651B to HP 1653B Upgrades

The HP 10349B oscilloscope upgrade kit converts the HP 1650B or HP 1651B logic analyzer to a HP 1652B or HP 1653B, respectively. The upgrade kit includes the following:

- 2-channel 400 MSa/s digitizing oscilloscope board
- software
- manual inserts

HP Service Center installation is highly recommended, and is not included in the price.

# LOGIC ANALYZERS

## Ordering Information

### Portable Logic Analyzers

<b>HP 1650B</b> 80-channel logic analyzer	\$7,900
<b>Opt 908</b> Rackmount tray	+\$300
<b>Opt 910</b> Extra operating and programming manual	+\$100
<b>Opt W30</b> Extended repair service. See page 723	+\$195
<b>HP 1651B</b> 32-Channel logic analyzer	\$3,900
<b>Opt 908</b> Rackmount tray	+\$300
<b>Opt 910</b> Extra operating and programming manual	+\$100
<b>Opt W30</b> Extended repair service. See page 723	+\$100
<b>HP 1652B</b> 80-channel logic analyzer with oscilloscope	\$11,300
<b>Opt 908</b> Rackmount tray	+\$300
<b>Opt 910</b> Extra operating and programming manual	+\$100
<b>Opt W30</b> Extended repair service. See page 723	+\$285
<b>HP 1653B</b> 32-Channel logic analyzer with oscilloscope	\$7,400
<b>Opt 908</b> Rackmount tray	+\$300
<b>Opt 910</b> Extra operating and programming manual	+\$100
<b>Opt W30</b> Extended repair service. See page 723	+\$185
<b>HP 1654B</b> 64-channel logic analyzer	\$6,700
<b>Opt 908</b> Rackmount tray	+\$300
<b>Opt 910</b> Extra operating and programming manual	+\$100
<b>Opt W30</b> Extended repair service. See page 723	+\$165

### Modular Logic Analyzers

<b>HP 16500A</b> Logic analysis system mainframe	\$7,500
<b>Opt 908</b> Rackmount kit (8 3/4" EIA rackmount)	+\$40
<b>Opt 910</b> Extra operating and programming manual	+\$100
<b>Opt W30</b> Extended repair service. See page 723	+\$180
<b>HP 16501A</b> Logic analysis system expansion frame	\$4,500
<b>Opt 908</b> Rackmount kit (8 3/4" EIA rackmount)	\$40
<b>Opt W30</b> Extended repair service. See page 723	\$115
<b>HP 16510B</b> 80-channel 35 MHz state/100 MHz timing	\$5,600
<b>Opt 910</b> Extra operating and programming manual	+\$100
<b>Opt W30</b> Extended repair service. See page 723	+\$130
<b>HP 16511B</b> 160-channel logic analyzer 35 MHz state/100 MHz timing conversion kit (2 HP 16510Bs needed)	\$500
<b>HP 16515A</b> 16-channel 1 GHz timing master card	\$8,100
<b>Opt 910</b> Extra operating and programming manual	+\$75
<b>Opt W30</b> Extended repair service. See page 723	+\$190
<b>HP 16516A</b> 16-channel 1 GHz timing expansion card	\$7,100
<b>Opt W30</b> Extended repair service. See page 723	+\$165
<b>HP 16520A</b> 12-channel 50 Mbit/s pattern generation card	\$4,000
<b>Opt 910</b> Extra operating and programming manual	+\$100
<b>Opt W30</b> Extended repair service. See page 723	+\$95
<b>HP 16521A</b> Pattern generator expansion card	\$4,500
<b>Opt W30</b> Extended repair service. See page 723	+\$95
<b>HP 16530A</b> 400 Msa/s oscilloscope timebase card	+\$1,650
<b>Opt 910</b> Extra operating and programming manual	+\$100
<b>Opt W30</b> Extended repair service. See page 723	+\$50
<b>HP 16531A</b> 2-channel 400 Msa/s scope acquisition card	\$4,500
<b>Opt W30</b> Extended repair service. See page 723	+\$100
<b>HP 16540A</b> 16-channel 100 MHz state master card	\$7,000
<b>Opt 910</b> Extra operating and programming manual	+\$100
<b>Opt W30</b> Extended Repair Service. See page 723	\$175
<b>Opt W32</b> Calibration service. See page 723.	\$465
<b>HP 16541A</b> 48-channel 100 MHz state expansion card	\$8,000
<b>Opt W30</b> Extended repair service. See page 723	\$200
<b>Opt W32</b> Extended calibration service	\$125

### Price

### Upgrade Kits

<b>HP 10449A</b> Software Upgrade Kit for HP 1650A/51A	\$500
<b>HP 16510-68703</b> Software Upgrade Kit for HP 16510A	\$95
<b>HP 10448A 35 MHz</b> State Upgrade Kit for HP 16510A	\$3,800
<b>HP 10349B</b> Scope Upgrade Kit for HP 1650B or HP 1651B	\$4,000
<b>HP 16500-68704</b> CPU Upgrade Kit for HP 16500A Mainframe	\$895
<b>HP 16500-68703</b> Current Operating Software Version (16500A)	\$25
<b>HP 01650-68703</b> Current Operation Software Version (1652B/53B)	\$25
<b>HP 01652-68703</b> Current Operation Software Version (1652B/53B)	\$25

Price for upgrade kits DOES NOT include installation.

### Accessory Software

<b>HP 10390A</b> System Performance Analysis Software	
<b>Opt 001</b> for the HP 1650A and HP 1650B	\$500
<b>Opt 002</b> for the HP 1651A and HP 1651B	\$500
<b>Opt 003</b> for the HP 16540A/41A	\$500
<b>HP 10391B</b> Inverse Assembler Development Package	\$1,000
<b>HP 10392A</b> State-to-Pattern Generator Link	\$500

### Probe Interface

<b>HP 10269C</b> General-purpose probe interface (required with many microprocessor support packages, see Microprocessor and Interface Support page 262).	\$470
---	-------

### Microprocessor Interfaces

<b>HP E2417A</b> AMD 29000 (PGA) preprocessor	\$1,600
<b>HP 10335G</b> Hitachi 6301/6303 (DIP) preprocessor	\$700
<b>HP 10336G</b> Hitachi 64180 (DIP) preprocessor	\$700
<b>HP 10336H</b> Hitachi 64180 (PLCC) preprocessor	\$1,300
<b>HP E2415A</b> Intel MCS-51 (DIP) preprocessor	\$1,400
<b>HP E2416A</b> Intel MCS-96 (PGA) preprocessor	\$650
<b>HP 10304B</b> Intel 8085 (DIP) preprocessor	\$1,000
<b>HP 10305B</b> Intel 8086/88 (DIP) preprocessor	\$1,400
<b>HP 10306G</b> Intel 80186/88 (PGA) preprocessor	\$700
<b>HP E2409A</b> Intel 80286 (PLCC/PGA) preprocessor	\$1,400
<b>HP 10314D</b> Intel 80386 (PGA) preprocessor	\$2,200
<b>HP E2403A</b> Intel 80486 (PGA) universal interface	\$1,400
<b>HP E2411A</b> Intel 80486 (PGA) preprocessor	\$2,200
<b>HP E2405A</b> Intel 80860 (PGA) universal interface	\$1,500
<b>HP 10311B</b> Motorola 68000/10 (DIP) preprocessor	\$1,600
<b>HP 10311G</b> Motorola 68000/10 (PGA) preprocessor	\$600
<b>HP E2426A</b> Motorola 68020 (PGA) preprocessor	\$850
<b>HP 10315G</b> Motorola 68HC11 (DIP) preprocessor	\$750
<b>HP 10315H</b> Motorola 68HC11 (PLCC) Preprocessor	\$1,800
<b>HP E2413A</b> Motorola 68332 EVS Logic Analysis Support	\$750
<b>HP E2414A</b> Motorola 68302 ADS Logic Analysis Support	\$400
<b>HP E2406A</b> Motorola 68030 50MHz (PGA) Preprocessor	\$2,000

☎ For same-day shipment, call HP DIRECT at 800 538-8787.

HP E2420A Motorola 68040 Preprocessor	\$2000	HP 5959-9333 5 probe leads for HP 1650 B series	\$25
HP E2400A Motorola 88200 (PGA) Preprocessor	\$1200	HP 5959-9334 5 short ground leads for HP 1650B, 1651B, 1652B, 1653B and 16510B	\$20
HP E2404A Motorola 88100 (PGA) Preprocessor	\$1700	HP 5959-9335 5 long ground leads for HP 1650B, 1651B, 1652B, 1653B and 16510B	\$20
HP E2418A Texas Instruments TMS320C25 Preprocessor	\$700	HP 01650-61608 16-channel probe lead set for HP 1650B/1651B/1652B/1653B/16510B	\$155
HP 10300B Zilog Z80 (DIP) Preprocessor	\$1000 ☎	HP 01650-63203 termination adaptor for HP 1650B/1651B/1652B/1653B/16510B	\$120

### Bus and Interface Preprocessors

HP 10342B HP-IB, RS-232C and RS-449 buses	\$1400
HP 10342G HP-IB bus	\$400
HP 10341B MIL-STD 1553A/B bus	\$4500
HP 10343B SCSI bus	\$1500
HP 10344A A-size VME bus	\$1000
HP E1323A B-size VME; B- & C-Size VXibus	\$1200

### User-Definable Interface Products

HP 10320C User-definable interface	\$300
HP 10321A Microprocessor interface parts kit	\$270
HP 10322A 40-pin DIP interface cable	\$480
HP 10323A 48-pin DIP interface cable	\$550
HP 10324A 64-pin DIP interface cable	\$670
HP 10391B Inverse assembler development package	\$1000

### Miscellaneous Accessories

HP E2421A Pomona 5514 SOIC Clip Kit	\$54.50
HP E2422A Pomona 5515 QUAD clip kit	\$197.50

### Printers and Accessories

HP 3630A PaintJet color graphics printer	\$1395 ☎
Opt 001 with RS-232C/V.24 interface	\$0
Opt 002 with HP-IB interface	\$0
HP 2225A ThinkJet printer with HP-IB interface	\$495 ☎
HP 2225D ThinkJet printer with RS-232C/V.24 interface	\$495 ☎
HP 92261A ThinkJet print cartridges	\$10.95 ☎
HP 92261N paper (2500 Sheets, for ThinkJet, DeskJet)	\$64.95 ☎
HP 92261S Mini-printer stand	\$49 ☎
HP 2276A DeskJet printer, Centronics/Rs-232C/v.24 Interface	\$795 ☎
HP 10833A HP-IB cable, 1m	\$80 ☎
13242-60010 RS-232C cable, 3m	\$69 ☎

### Oscilloscope Accessories

HP 10503A BNC-to-BNC cable, 1.2m	\$35 ☎
HP 10240B BNC-to-BNC blocking capacitor	\$45
HP 10211A IC probe clip	\$81
HP 10024A 16-pin IC test clip	\$20

### Oscilloscope Probes

HP 10020A 1:1-100, 50-5000 Ω, < 1 pF resistive divider probe set, 1.2m	\$495
HP 10430A 10:1, 1 MΩ, 6.5 Pf mini-probe, 1m	\$115
HP 10433A 10:1, 10 MΩ, 10 pF mini-probe, 2m	\$105 ☎
HP 10435A 10:1, 1 MΩ, 7.5 pF mini-probe, 1m	\$115 ☎
HP 10437A 1:1, 50 Ω, mini-probe, 2m	\$80 ☎
HP 10438A 1:1, 1 MΩ, 40 pF mini-probe, 1m	\$85 ☎
HP 10439A 1:1, 1 MΩ, 64 pF mini-probe, 2m	\$90 ☎
HP 10440A 100:1, 10 MΩ, 2.5 pF mini-probe, 2m	\$115 ☎

### State and Timing Analyzer Replacement Probes and Lead Sets

HP 01650-61607 16-channel woven probe cable for 1650B, 1651B, 1652B and 1653B	\$125
HP 16510-61601 16-channel woven probe cable for HP 16510B	\$160
HP 16510-61602 16-channel woven probe cable for HP 16510B	\$140

HP 1810-1278 9-channel IC termination adaptor	\$5
HP 1251-8106 2 x 10, 0.1" center header (similar to 3-M <sup>1</sup> p/n 3592-6002)	\$7.50
HP 5090-4356 Surface-mount grabbers (package of 20)	\$25
HP 5959-0288 Throughhole grabbers (package of 20)	\$20
HP 16515-61604 1-channel coax probe cable for HP 16515A/16516A	\$72.50
HP 16515-69502 8 1-channel lead set for HP 16515A/16516A	\$125
HP 16515-68703 grounding kit for HP 16515A/16516A	\$150
HP 16515-68705 Probe pins for HP 16515A/16516A	\$120
HP 16515-63202 1 GHz Timing Termination Adaptor	\$150

### Pattern Generator Accessories; Replacement Probes and Lead Sets

HP 10392A state-to-pattern generator link	\$500
HP 16520-61601 Input qualifier probe cable	\$110
HP 16520-69501 Input qualifier probe kit	\$155
HP 16520-61602 8-channel data probe cable	\$175
HP 16520-61603 Clock/strobe probe cable	\$185
HP 10347A Pattern generator probe lead set	\$200
HP 10345A 8-channel ECL differential driver pod	\$120
HP 10346A 8-channel TTL tristate buffer pod	\$120
HP 10348A 8-channel CMOS tristate buffer pod	\$120
HP 5959-0288 grabbers (package of 20)	\$20

### Other Accessories for the HP 1650B/1651B/1652B/1653B

HP 1180A Testmobile for HP 1650B/1651B/1652B/1653B	\$290
HP 92199B Power strip	\$36
HP 1540-1066 Soft carrying case for HP 1650B/1651B/1652B/1653B	\$135
HP 92192A Blank double-sided 3.5" diskette (box of 10)	\$19
HP 5061-6175 Rackmount kit for HP 1650B/1651B/1652B/1653B	\$300
HP 1494-0015 Rackmount slide tray for HP 1650B/1651B/1652B/1653B	\$120
HP 9211-2645 Transit Case	\$430
HP 1650B/1652B/1652B/1653B	
HP 5061-6183 Front Cover for HP 1650B/1651B/1652B/1653B	\$35

### Other Accessories for the HP 16500A

HP 92192A Blank double-sided 3.5" diskettes (box of 10)	\$29
HP 1008A Testmobile for the HP 16500A	\$970
Option 006 Power strip and cabinet	+\$270
HP 46060A HP Mouse	\$155
HP M1309A Trackball	\$302
HP 5061-9679 Rackmount kit for HP 16500A	\$40
HP 9211-2658 Transit case for HP 16500A	\$520

☎ For same-day shipment, call HP DIRECT at 800-538-8787.  
<sup>1</sup>3-M is a registered trademark of Minnesota Mining and Manufacturing Corporation.

# DIGITAL CIRCUIT TESTERS

**Signature Multimeter, Combines Counter and Multimeter Functions with Signature Analysis**  
**HP 5005B**

- Digital and analog measurement capability optimized for digital troubleshooting
- Easy to use single probe measurement of logic signals, voltage, and frequency

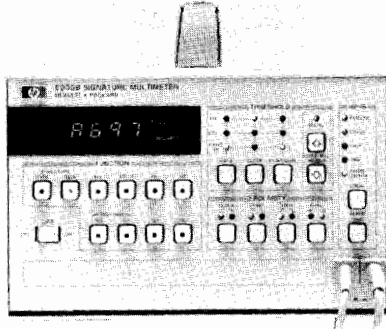

HP 5005B



## HP 5005B

Total checkout of a digital system often requires characterizing both digital data activity and analog signal parameters. A typical troubleshooting procedure may specify a digital multimeter for checking power supplies and circuit board integrity (shorts and opens), a universal counter to measure clock frequencies and time intervals between signals, and a means to verify the analog integrity of active digital signals. The HP 5005B Signature Multimeter offers, in a single instrument, a measurement set optimized for these types of digital troubleshooting applications.

- Field proven Signature Analysis (for multiple logic families).
- Digital multimeter (DC volts, resistance and differential voltage).
- Frequency counter (frequency, totalize, time interval).
- Voltage threshold (upper voltage peak, lower voltage peak).
- Multifunction probe.

### Signature Analysis

HP's patented Signature Analysis technique enables the HP 5005B to generate a compressed, four digit "fingerprint" or signature of the digital data stream at a logic node. Any fault associated with a device connected through the node will force a change in the data stream and, consequently, produce an erroneous signature.

Specific features of the HP 5005B Signature Analyzer include:

- Multiple logic family compatibility—preset threshold levels for TTL, CMOS, and ECL or adjustable thresholds (+12.5 V to -12.5 V) assure coverage of a wide variety of logic device types.
- 25 MHz clock frequency—extends Signature Analysis to high speed circuits such as CRT controllers.
- Qualified signature mode—speeds fault isolation in complex products by windowing signature collection to specific modules or devices without requiring major test setup changes. This simplifies the engineering involvement in hardware and software testability and accelerates test procedure preparation.

### Digital Multimeter

Certain digital problems result from analog circuit failures: a low power supply voltage, an open or shorted circuit path, a faulty A/D or D/A converter. Each may contribute to a system failure. The HP 5005B contains a 4½ digit dc voltmeter, ohmmeter, and differential voltmeter, each with performance geared toward analog measurements necessary in digital troubleshooting.

The implementation of each multimeter function emphasizes simplicity and convenience. Automatic internal self calibration and auto-ranging maximize troubleshooting efficiency by eliminating unnecessary interaction with the instrument. Improvements in display interpretation also aid troubleshooting. The ohmmeter, for example, when measuring an open circuit, produces an "OPEN" indication on the display rather than the typical overload display.

- 25 MHz, multiple logic family signature analysis with qualified clocking mode
- Complete HB-IB programmability of every function

### Frequency Counter

The counter within the HP 5005B provides totalize and frequency measurements to 50 MHz, and time interval measurements to 100 nanosecond resolution. Intended to extend the digital troubleshooting capabilities of the Signature Analysis (synchronous measurements), the counter functions provide the ability to characterize one-shots and timers through time interval measurement; test interrupt lines, reset lines, and asynchronous communication interfaces (RS-232) through totalize; and verify clock and clock driver circuitry through frequency measurement.

### Voltage Threshold

Logic level degradation is a common and troublesome malfunction in digital products. Isolating this failure typically requires displaying and interpreting the waveform. The HP 5005B's peak voltage measurement mode provides a simple, direct method of measuring logic high and logic low voltage of active digital signals.

The peak voltage measurement mode allows the HP 5005B to characterize and display either the greatest (positive peak) or the lowest (negative peak) voltage measured at the probe. Selection of either positive peak or negative peak mode displays the appropriate measured threshold for comparison against the specifications of the logic family.

### Multifunction Probe

Several measurement functions incorporated into a single instrument can provide optimal troubleshooting efficiency only when each function is easy to use. The operator, when troubleshooting, must be able to measure the analog signal parameters and digital functional characteristics of a node without requiring time consuming and error-prone probe or instrument setup changes. The HP 5005B multifunction probe solves this problem by providing automatic access to the Signature Analyzer, multimeter, and counter functions through a single probe. All signal multiplexing to the appropriate measurement function is accomplished inside the HP 5005B.

This efficient probing scheme becomes particularly important in automatic applications. The HP 5005B takes advantage of the several functions available in the multifunction probe. A switch, located on the side of the probe, allows the operator to trigger automatic measurement. The instrument controller can then characterize both the analog parameters and functional digital operation of a circuit node while the operator probes the same point. This greater automatic measurement efficiency translates into increased troubleshooting productivity.

### HP-IB Programmability

Complete programmability makes the HP 5005B an ideal choice for automatic digital testing and troubleshooting. Every HP 5005B measurement and control function can be programmed through the HP-IB interface. This flexibility allows the automatic test system designer full access to the many measurement functions in the instrument.

Simplified programming enhances the automatic testing and troubleshooting productivity improvements inherent in the HP 5005B. Straightforward commands and data output formats aid in accelerating test program development. A measurement trigger switch located in the probe allows direct operator communication to the controller. Audible feedback, supplied by the beeper in the HP 5005B, can then indicate the completion of the measurement cycle. This closed-loop communication (controller-to-operator) aids in improving trouble-shooting efficiency.

## HP 5005B Specifications

### Signature

**Display:** 4 digits. Characters 0-9, ACFHPU.

**Fault detection accuracy:** 100% probability of detecting single-bit errors; 99.998% probability of detecting multiple-bit errors.

**Minimum gate length:** 1 clock cycle (1 data bit) between START and STOP.

**Maximum gate length:** no limit.

**Minimum timing between gates:** 1 clock cycle between STOP and START.

### Data Probe Timing

**Setup time:** 10 ns (data to be valid at least 10 ns before selected clock edge.)

**Hold time:** 0 ns (data to be held until occurrence of selected clock edge.)

### START, STOP, QUAL Timing

**Setup time:** 20 ns (signals to be valid at least 20 ns before selected clock edge.)

**Hold time:** 0 ns (signals to be held until occurrence of selected clock edge.)

### CLOCK Timing

**Maximum clock frequency:** 25 MHz.

**Minimum pulse width:** 15 ns in high or low state.

**Qualify mode:** allows data clock qualification by an external signal. DATA probe input impedance  $\approx 50$  k $\Omega$  to the average value of "0" and "1" threshold settings ( $\pm 6$  V max); 15 pF.

START, STOP, CLOCK, QUAL input impedance  $\approx 100$  k $\Omega$ ; 15 pF.

**Front panel indicators:** flashing GATE light indicates detection of valid START, STOP, CLOCK conditions. Flashing UNSTABLE light indicates a difference between 2 successive signatures, and possible intermittent faults.

### Frequency

**Display:** 5 digits.

**Ranges:** 100 kHz, 1 MHz, 10 MHz, 50 MHz, autoranged.

**Resolution:** 1 LSD (1 Hz on 100 kHz range).

**Accuracy:**  $\pm 0.01\%$  of reading  $\pm 1$  count.

Minimum pulse width  $\approx 10$  ns in high or low state.

Gate time  $\approx 1$  s, fixed.

Input impedance  $\approx 50$  k $\Omega$  to the average value of "0" and "1" threshold settings ( $\pm 6$  V max); 15 pF.

### Totalizing

**Display:** 5 digits.

**Range:** 0-99,999 counts.

**Resolution:** 1 count.

Maximum input frequency  $\approx 50$  MHz, with a minimum pulse width of 10 ns, and minimum pulse separation of 10 ns.

Minimum START/STOP pulse width  $\approx 20$  ns.

DATA input impedance  $\approx 50$  k $\Omega$  to the average value of "0" and "1" threshold settings ( $\pm 6$  V max); 15 pF.

START, STOP input impedance  $\approx 100$  k $\Omega$ ; 15 pF.

### Time Interval

**Display:** 5 digits.

**Ranges:** 10 ms, 100 ms, 1 s, 10 s, 100 s, autoranged.

**Resolution:** 1 count (100 ns on 10 ms range).

**Accuracy:**  $\pm 0.01\%$  of reading  $\pm 2$  counts.

Minimum START/STOP pulse width  $\approx 20$  ns.

START, STOP input impedance  $\approx 100$  k $\Omega$ ;

### Resistance

**Display:** 4 or 5 digits, depending on range.

**Ranges:** 30 k $\Omega$ , 300 k $\Omega$ , 1 M $\Omega$ , 3 M $\Omega$ , 10 M $\Omega$ , autoranged.

**Accuracy:** (at 15°C–30°C).

Range	Full Scale	Accuracy	Display Resolution
30 k $\Omega$	29.999 k $\Omega$	$\pm 1\%$ of reading $\pm 2$ $\Omega$	1 $\Omega$
300 k $\Omega$	299.99 k $\Omega$	$\pm 1\%$ of reading	10 $\Omega$
1 M $\Omega$	999.9 k $\Omega$	$\pm 1\%$ of reading	100 $\Omega$
3 M $\Omega$	2999. k $\Omega$	$\pm 10\%$ or reading	1 k $\Omega$
10 M $\Omega$	10000. k $\Omega$	$\pm 10\%$ of reading	10 k $\Omega$

Input impedance  $\approx 20$  k $\Omega$  to  $\pm 2$  V

### DC Voltage

**Display:** 4½ digits.

**Ranges:**  $\pm 25$  V,  $\pm 250$  V, autoranged; referenced to earth ground.

**Accuracy:** (at 15°C–30°C).

Range	Accuracy	Resolution
25 V	$\pm 0.1\%$ of reading $\pm 2$ mV	1 mV
250 V (<100 V)	$\pm 0.25\%$ of reading $\pm 20$ mV	10 mV
250 V ( $\geq 100$ V)	$\pm 0.25\%$ of reading $\pm 20$ mV	100 mV

Input impedance  $\approx 10$  M $\Omega$ .

### Differential Voltage

**Reading:** reads input voltage present at the probe and displays difference between it and voltage at the time  $\Delta V$  key was depressed.

**Specifications:** same as for dcV, above. Voltage range is determined by larger of 2 compared voltages.

### Peak Voltage

**Display:** 3½ digits.

**Range:** 0– $\pm 12$  Vp.

**Resolution:** 50 mV.

**Accuracy:**  $\pm 2\%$  of reading  $\pm 5\%$  of p-p signal  $\pm 100$  mV.

Minimum peak duration  $\approx 10$  ns.

Maximum time between peaks  $\approx 50$  ms.

Input impedance  $\approx 100$  k $\Omega$ ; 15 pF.

### Signature Analyzer Logic Thresholds

Pre-set thresholds: TTL, ECL, CMOS.

**Adjustable thresholds:** each preset threshold can be adjusted.

**Range:**  $\pm 12.5$  V, in 50 mV steps.

**Accuracy:**  $\pm 2\%$  of setting,  $\pm 2$  V

Logic threshold circuitry is operative during NORM, QUAL, kHz, TOTLZ and ms measurements.

### General

**Data probe tip:** acts as high-speed logic probe in the NORM, QUAL, kHz and TOTLZ modes. Lamp indicates high, low, bad-level and pulsing states.

Minimum detected pulse width is 10 ns.

### Data Probe Protection

#### Continuous Overload

**DCV,  $\Delta V$ , k $\Omega$  modes only:**  $\pm 250$  V ac/dc.

**All other modes:**  $\pm 150$  V ac/dc, 20 V rms at input frequencies  $> 2$  MHz.

**Intermittent overload:**  $\pm 250$  V ac/dc, up to 1 min, for all modes.

#### Timing Pod Protection

**Continuous overload:**  $\pm 100$  V ac/dc, 20 V rms at input frequencies  $> 2$  MHz.

**Intermittent overload:**  $\pm 140$  V ac/dc, up to 1 min.

**Auxiliary power supply:** three rear-panel connectors supply 5 V at 0.7A total for accessories (HP 5005A only)

**Operating temperature:** 0°C to +55°C.

**Power:** selectable 100 V, 120 V, 220 V or 240 V ac line (+5%–10%), 48–66 Hz, 35 VA maximum.

**Weight:** Net: 5.5 kg (12.0 lb.) Shipping: 8.7 kg (19 lb.).

**Size:** 133 H x 212 W x 432 mm D (5¼" x 8¾" x 17"), excluding handle.

### Ordering Information

HP 5005B Signature Multimeter

Opt 910 Additional Manual

### Price

\$6,700

+ \$70

# DIGITAL CIRCUIT TESTERS

## Signature Analyzer, A Digital Troubleshooting Tool

### HP 5006A

- Reduce warranty and service support costs
- Full at-speed testing of digital products

- Reduce comparisons to documentation with composite signature
- Compare signatures in groups with signature memory

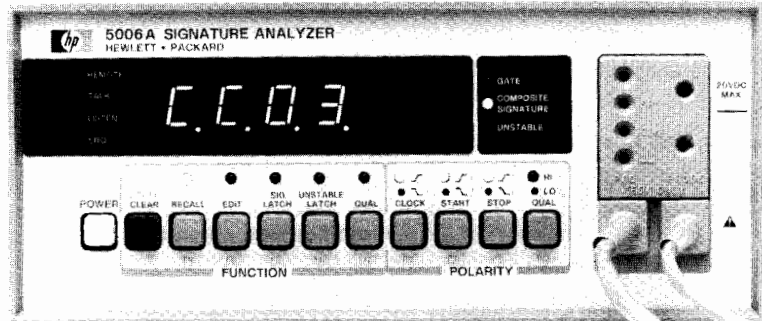

HP 5006A

### HP 5006A Signature Analyzer

#### The Technique

Signature Analysis is a fast and accurate troubleshooting method for digital circuits. Fault finding is reduced to tracing signal flow and comparing measured signatures to those recorded on paper or in a computer. Troubleshoot with Signature Analysis by probing the circuit, reading the display and comparing to the known good signature. A signature is a cyclic redundancy code (CRC) used as an error detection check on blocks of data. Test patterns may be generated within a circuit or stimulated externally.

#### Programmability Means Efficiency

The HP 5006A is completely programmable using the optional HP-IB interface. Upgrade production test and troubleshooting systems to include digital troubleshooting by adding the HP-IB option.

Signatures compress the necessary troubleshooting information of a bit stream into 16 bits. Instead of entire bit streams, only signatures need be compared to detect bit errors in the unit under test.

#### Time Savers

Composite signature and signature memory save time for the troubleshooter who does not have a computer-aided system. Composite signature is the binary sum of individual signatures. The HP 5006A computes it for any grouping of digital signals (i.e., bus or IC). Only one "composite" signature need be compared to documentation if all signals for that group are good.

Signatures are stored in the HP 5006A memory after the probe switch is pushed. The memory stores the last 32 signatures probed. Individual signatures can now be compared in groups instead of after each probe by reviewing the memory in the RECALL mode.

### HP 5006A Specifications

#### General

**Display:** 4 digits. Characters 0-9, ACFHPU.

**Fault detection accuracy:** 100% probability of detecting single-bit errors; 99.998% probability of detecting multiple-bit errors.

**Composite signature:** maximum number of signatures: No limit.

Sums all signatures, triggered by probe switch, following depression of CLEAR key, or power-up.

**Signature memory:** signatures recallable by probe switch: The last 32 signatures triggered by probe switch.

#### Timing

**Clock:** maximum frequency: 25 MHz. Minimum clock time: 15 ns in high or low state.

**Probe:** setup time: 10 ns with 0.2 V overdrive. (Data to be valid at least 10 ns before selected clock edge.) Hold time: 0 ns. (Data to be held after occurrence of selected clock edge.)

**Start, stop, qualifier:** setup time: 20 ns with 0.2 V overdrive. (Data to be valid at least 20 ns before selected clock edge.) Hold time: 0 ns. (Data to be held until occurrence of selected clock edge.) Minimum gate length: 1 clock cycle (1 data bit) between START and STOP.

Maximum gate length: no limit.

Minimum timing between gates: 1 clock cycle between STOP and START.

#### Input Impedance

**Probe:** 50 k $\Omega$  to ground nominal.

**Pod:** 100 k $\Omega$  to ground nominal.

#### Overload Protection

**Probe:**  $\pm 150$  V continuous.

$\pm 250$  V intermittent.

250 Vac for 1 minute.

**Pod:**  $\pm 20$  V continuous.

$\pm 140$  V intermittent.

$\pm 140$  Vac for 1 minute.

**CMOS sense:** 20 Vdc maximum.

#### TTL Thresholds

**Probe:** Logic one: 2 V + .2-.3. Logic zero: 0.8 V +.3-.2

**Pod:** 1.4 V  $\pm 6$

#### CMOS Thresholds

**Logic one:** 70% of sensed voltage.

**Logic zero:** 30% of sensed voltage.

#### Display and Indicators

**Signature:** four seven-segment digits with decimal point.

**Lamps:** Key Status: Recall, edit, signature latch, unstable latch, qualify mode, timing polarities. Programmable: Remote, talk, listen, SRQ. (Option 040). Status: Composite signature, gate, unstable.

**Probe:** logic levels indicated: High, low, open and pulsing. Minimum pulse width: 10 ns.

#### Other

**Selectable power:** 115 V +10%-25% ac line, 48-440 Hz.

230 V +10%-15% ac line, 48-66 Hz. 25 VA maximum.

**Operating environment:** temperature: 0-55°C. Humidity: 95% RH at +40°C. Altitude: 4600 m (15,000 ft).

**Size:** 89 mm H x 216 mm W 279 mm D (3-1/2 in. x 8-1/2 in. x 11 in.).

**Net weight:** 2.4 kg (5.3 lb). Shipping weight: 4.1 kg (9 lb).

#### Ordering Information

HP 5006A Signature Analyzer

Opt 40 HP-IB Interface

Opt 910 Additional Manual

HP 5060-0173 Half Rack Mount Kit

#### Price

\$2,200

+\$300

+\$16.50

\$85



## HP 545A TTL/CMOS Logic Probe

The HP 545A Logic Probe contains all the features built into other HP probes, plus switch-selectable, multi-family operation and built-in pulse memory. Employing straightforward one-lamp display the HP 545A operates from 3 to 18 volts in CMOS applications or from 4.5 to 15 Vdc supplies in the TTL mode while maintaining standard TTL thresholds.

The probe's independent, built-in pulse memory and LED display help you capture hard to see, intermittent pulses. Just connect the probe tip to a circuit point, reset the memory, and wait for the probe to catch those hard to find glitches.

The hand-held HP 545A is light, rugged, overload protected, and very fast: 80 MHz in TTL, 40 MHz in CMOS. It also employs handy power supply connectors that enable you to easily hook up to supply voltage almost anywhere in the unit under test.

## HP 545A Probe Specifications

**Input current:**  $\leq 15 \mu\text{A}$  (source or sink).

**Input capacitance:**  $\leq 15 \text{ pF}$ .

### Logic thresholds

\*TTL: Logic one  $2.0 + 0.4$ ,  $-0.2 \text{ V}$ . Logic zero  $0.8 + 0.2$ ,  $-0.4 \text{ V}$ .

CMOS: 3–10 Vdc supply

Logic one:  $0.7 \times V_{\text{supply}} \pm 0.5 \text{ Vdc}$ .

Logic zero:  $0.3 \times V_{\text{supply}} \pm 0.5 \text{ Vdc}$ .

CMOS:  $\geq 10$ –18 Vdc supply.

Logic one:  $0.7 \times V_{\text{supply}} \pm 1.0 \text{ Vdc}$ .

Logic zero:  $0.3 \times V_{\text{supply}} \pm 1.0 \text{ Vdc}$ .

**Input minimum pulse width:** 10 ns using ground lead (typically 20 ns without ground lead).

**Input maximum pulse repetition frequency:**

TTL, 80 MHz. CMOS, 40 MHz.

**Input overload protection:**  $\pm 120 \text{ V}$  continuous (dc to 1 kHz);  $\pm 250$  for 15 seconds (dc to 1 kHz).

**Pulse memory:** indicates first entry into valid logic level; also indicates return to initial valid level from bad level for pulse  $\geq 1 \mu\text{s}$  wide.

### Power Requirements

TTL: 4.5 to 15 Vdc\*.

CMOS: 3 to 18 Vdc.

**Maximum current:** 70 mA.

**Overload protection:**  $\pm 25 \text{ Vdc}$  for one minute.

**Accessory included:** ground clip.

\* $\pm 5$ – $\pm 10\%$  Vdc power supply; usable to  $+15 \text{ Vdc}$  with slightly increased logic low threshold.

## HP 546A Logic Pulser

The Logic Pulser solves the problem of how to pulse IC's in digital circuits. Merely touch the Pulser to the circuit under test, press the pulse button and all circuits connected to the node (outputs as well as inputs) are briefly driven to their opposite state. No unsoldering of IC outputs is required. Pulse injection is automatic, high nodes are pulsed low and low nodes, high, each time the button is pressed.

Automatic polarity pulse output, pulse width, and amplitude make for easy multi-family operation when you use the HP 546A Logic Pulser. But, the real surprise comes when you code in one of its six ROM-programmable output patterns (single pulses; pulse streams of either 1, 10, or 100 Hz; or bursts of 10 or 100 Hz; or bursts of 10 or 100 pulses). This feature allows you to continually pulse a circuit when necessary, or it also provides an easy means to put an exact number of pulses into counters and shift registers. Used with our multi-family IC Troubleshooters, the HP 546A acts as both a voltage and current source in digital troubleshooting applications.

## HP 546A Pulser Specifications

### Output

Family	Output Current	Pulse Width	Typical Output Voltage	
			HIGH	LOW
TTL/DTL	$\leq 650 \text{ mA}$	$\geq 0.5 \mu\text{s}$	$\geq 3 \text{ Vdc}$	$\leq 0.8 \text{ Vdc}$
CMOS	$\leq 100 \text{ mA}$	$\geq 5.0 \mu\text{s}$	$\geq (V_{\text{supply}} - 1 \text{ Vdc})$	$\leq 0.5 \text{ Vdc}$

**Power supply requirements:** TTL; 4.5 to 5.5 Vdc at 35 mA, CMOS; 3 to 18 Vdc at 35 mA, protected to  $\pm 25 \text{ Vdc}$  for 1 min.

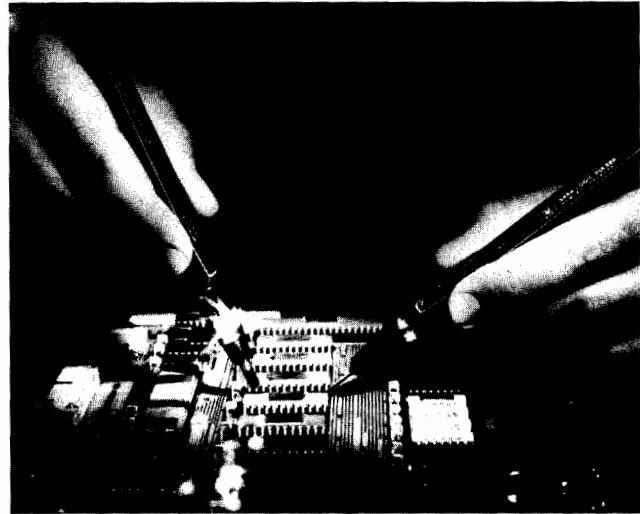

HP 547A/546A

## HP 547A Digital Current Tracer

The HP 547A Current Tracer precisely locates low-impedance faults in digital circuits by locating current sources or sinks. For example, on a bad node the Tracer can verify that the driver is functioning and also show where the problem is by tracing current flow to the source or sink causing the node to be stuck. The Tracer is designed to troubleshoot circuits carrying fast rise-time current pulses. The Tracer senses the magnetic field generated by these signals in the circuit and displays transitions, single pulses, and pulse trains using a simple one-light indicator. Because it is not voltage sensitive, the Tracer operates on all logic families having current pulses exceeding 1 mA, including CMOS, where even lightly loaded outputs can have up to 2 to 3 mA of instantaneous charging current.

To use the Tracer, align the dot on its tip at a reference point, usually the output of a node driver. Set the sensitivity control to indicate the presence of ac current activity. As you probe from point to point or follow traces, the lamp will change intensity; when you find the fault the Tracer will indicate the same brightness found at the reference point.

## HP 547A Current Tracer Specifications

### Input

**Sensitivity:** 1 mA to 1 A.

**Frequency response:** light indicates single-step current transitions; single pulses  $\geq 50 \text{ ns}$  in width; pulse trains to 10 MHz (typically 20 MHz for current pulses  $\geq 10 \text{ mA}$ ).

**Risetime:** light indicates current transitions with risetime  $\leq 200 \text{ ns}$  at 1 mA.

### Power Supply Requirements

**Voltage:** 4.5 to 18 Vdc.

**Input current:**  $\leq 75 \text{ mA}$ .

**Maximum ripple:**  $\pm 500 \text{ mV}$  above 5 Vdc.

**Overvoltage protection:**  $\pm 25 \text{ Vdc}$  for one minute.

## Ordering Information

HP 545A Logic Probe

HP 546A Logic Pulser

HP 547A Digital Current Tracer

### Accessories Available

HP 00545-60104: Tip Kit for HP 546A Pulser, 545A Probe

HP 10526-60002: Multi-Pin Stimulus Kit

HP 1250-1948 Adapter, Coax Str.

☎ For same day shipment, call HP DIRECT at 800-538-8787.

## Price

HP 545A Logic Probe \$260 ☎

HP 546A Logic Pulser \$350 ☎

HP 547A Digital Current Tracer \$630 ☎

HP 00545-60104: Tip Kit for HP 546A Pulser, 545A Probe \$65 ☎

HP 10526-60002: Multi-Pin Stimulus Kit \$75 ☎

HP 1250-1948 Adapter, Coax Str. \$25

# DIGITAL CIRCUIT TESTERS

## Logic Clip, Logic Comparator

HP 548A & 10529A



HP 548A

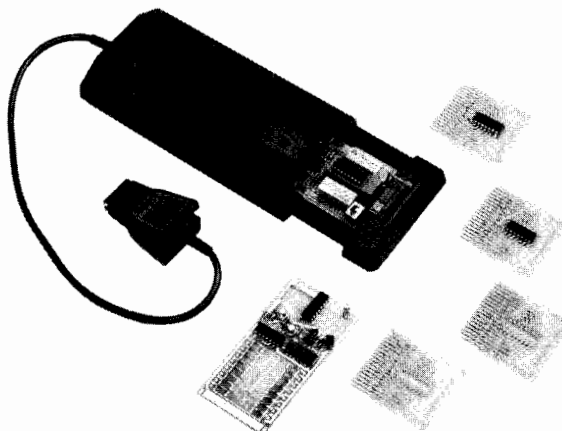

HP 10529A

### HP 548A Logic Clip

The Logic Clip is an extremely handy service and design tool which clips onto dual-in-line package (DIP) ICs, instantly displaying the states of up to 16 pins. Each of the clip's 16 LEDs independently follows level changes at its associated pin. Lit diodes are logic High, extinguished diodes are Low.

The Logic Clip's real value is in its ease of use. It has no controls to set, needs no power connections, and requires practically no explanation as to how it is used. The clip has its own gating logic for locating ground and  $V_{CC}$  pins and its buffered inputs reduce circuit loading.

The Logic Clip is much easier to use than either an oscilloscope or a voltmeter when you are interested in whether a circuit is in the high or low state, rather than its actual voltage. The Clip, in effect, is 16 binary voltmeters, and the user does not have to shift his eyes away from his circuit to make the readings.

The intuitive relationship of the input to the output—lighted diode corresponding a high logic state—greatly simplifies the troubleshooting procedure. The user is free to concentrate his attention on his circuits, rather than on measurement techniques. Also, timing relationships become especially apparent when clock rates can be slowed to about 1 pulse per second.

When used in conjunction with the Logic Pulser, the Logic Clip offers unparalleled analysis capability for troubleshooting sequential Logic Devices used to inject pulses between gates allowing it to supply signals to the IC under test absolutely independent of gates connected to the IC. All outputs may then be observed simultaneously on the Logic Clip. Deviations from expected results are immediately apparent as the Pulser steps the IC through its truth table.

### HP 548A Multi-Family Logic Clip

Fully automatic and protected to 30 Vdc, and employing bright individual LEDs in its display, the HP 548A brings multi-family operation to the HP line of IC Troubleshooters. The Clip can be externally powered, if desired, using a simple power connector.

### HP 548A Specifications

**Input threshold:**  $(\geq 0.4 \pm 0.06 \times \text{Supply Voltage}) = \text{Logic High}$ .

**Input impedance:** 1 CMOS load per input.

**Input protection:** 30 Vdc for 1 minute.

**Supply voltage:** 4-18 Vdc across any two pins.

**Auxiliary supply input:** 4.5 to 20 Vdc applied via connector. Supply must be  $\geq 1.5$  Vdc more positive than any pin of IC under test.

**Supply current:** <55 mA.

### Ordering Information

HP 548A Logic Clip

☎ For same day shipment, call HP DIRECT at 800-538-8787.

### Price

\$320 ☎

### HP 10529A Logic Comparator

The HP 10529A Logic Comparator clips onto powered TTL or DTL ICs and detects functional failures by comparing the in-circuit test IC with a known good reference IC inserted in the Comparator. Outputs of the particular IC to be tested are selected via 16 miniature switches which tell the Comparator which pins of the reference IC are inputs and which are outputs. Any logic state difference between the test IC and reference IC is identified to the specific pin(s) on 14- or 16-pin dual in-line packages on the Comparator's display. A lighted LED corresponds to a logic difference. Intermittent errors as short as 300 nanoseconds (using the socket board) are detected, and the error indication on the Comparator's display is stretched for a visual indication. A failure on an input pin, such as an internal short, will appear as a failure on the IC driving the failed IC; thus a failure indication actually pinpoints a malfunctioning node. A test board is supplied to exercise all of the circuitry, test leads, and display elements to verify proper operation.

HP 10541A: twenty additional blank reference boards; identical to the 10 boards provided with the Logic Comparator.

HP 10541B: twenty preprogrammed reference boards. The 10541B includes the following ICs: 7400, 7402, 7404, 7408, 7410, 7420, 7430, 7440, 7451, 7454, 7473, 7474, 7475, 7476, 7483, 7486, 7490, 7493, 74121, 9601.

### HP 10529A Specifications

**Input threshold:** 1.4 V nominal (1.8 V nominal with socket board), TTL or DTL compatible.

**Test IC loading:** outputs driving Test IC inputs are loaded by 5 low-power TTL loads plus input of Reference IC. Test IC outputs are loaded by 2 low-power TTL loads.

**Input protection:** voltages  $< -1$  V or  $> 7$  V must be current limited to 10 mA.

**Supply voltage:** 5 V  $\pm 5\%$ , at 300 mA.

**Supply protection:** supply voltage must be limited to 7 V.

**Maximum current consumption:** 300 mA.

### Sensitivity

**Error sensitivity:** 200 ns with reference board or 300 ns with socket board. Errors greater than this are detected and stretched to at least 0.1 second.

**Delayed variation immunity:** 50 ns. Errors shorter than this value are considered spurious and ignored.

**Frequency range:** maximum operational frequency varies with duty cycle. An error existing for a full clock cycle will be detected if the cycle rate is less than 3 MHz.

**Accessories included:** 1 test board; 10 blank reference boards; 1 programmable socket board; 1 carrying case.

### Ordering Information

HP 10529A Logic Comparator

### Accessories Available

HP 10541A: Twenty Blank Reference Boards

HP 10541B: Twenty Pre-programmed Boards

### Price

\$1100 ☎

\$170 ☎

\$440 ☎

# DIGITAL CIRCUIT TESTERS

## Logic Troubleshooting Kits

HP 5011T, 5021A, 5022A, 5023A & 5024A

299

- Complete multi-family kits
- Stimulus-response capability
- In-circuit fault finding

- In-circuit analysis
- Dynamic and static testing
- Multi-pin testing

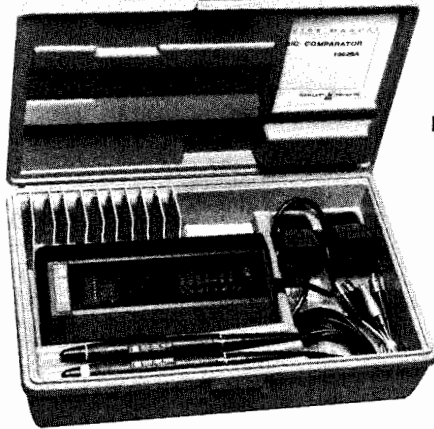

HP 5011T

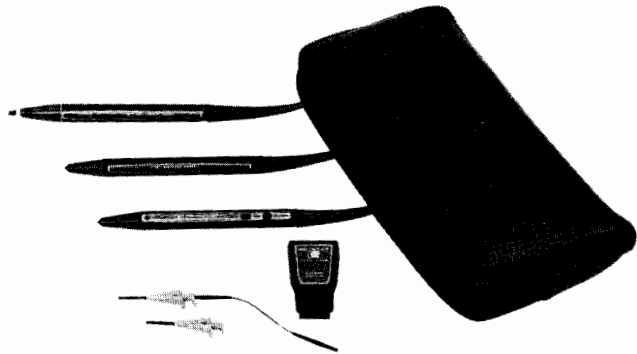

HP 5022A

FAULT	STIMULUS	RESPONSE	TEST METHOD
Shorted Node <sup>1</sup>	Pulser <sup>2</sup>	Current Tracer	<ul style="list-style-type: none"> <li>• Pulse shorted node</li> <li>• Follow current pulses to short</li> </ul>
Stuck Data Bus	Pulser <sup>2</sup>	Current Tracer	<ul style="list-style-type: none"> <li>• Pulse bus line(s)</li> <li>• Trace current to device holding the bus in a stuck condition</li> </ul>
Signal Line Short to Vcc or Ground	Pulser	Probe, Current Tracer	<ul style="list-style-type: none"> <li>• Pulse and probe test point simultaneously</li> <li>• Short to Vcc or Ground cannot be overridden by pulsing</li> <li>• Pulse test point, and follow current pulses to the short</li> </ul>
Supply to Ground Short	Pulser	Current Tracer	<ul style="list-style-type: none"> <li>• Remove power from circuit under test</li> <li>• Disconnect electrolytic bypass capacitors</li> <li>• Pulse across Vcc and ground using accessory connectors provided</li> <li>• Trace current to fault</li> </ul>
Internally Open IC	Pulser <sup>2</sup>	Probe	<ul style="list-style-type: none"> <li>• Pulse device input(s)</li> <li>• Probe output for response</li> </ul>
Solder Bridge	Pulser <sup>2</sup>	Current Tracer	<ul style="list-style-type: none"> <li>• Pulse suspect line(s)</li> <li>• Trace current pulses to the fault</li> <li>• Light goes out when solder bridge passed</li> </ul>
Sequential Logic Fault in Counter or Shift Register	Pulser	Clip	<ul style="list-style-type: none"> <li>• Circuit clock de-activated</li> <li>• Use Pulser to enter desired number of pulses</li> <li>• Place Clip on counter or shift register and verify device truth table</li> </ul>

1. A node is an interconnection between two or more IC's.

2. Use the Pulser to provide stimulus or use normal circuit signals, whichever is most convenient.

Used individually, each of HP's IC Troubleshooters provide their own unique and important troubleshooting function. Together they become invaluable stimulus-response testing partners that help pinpoint faults and ensure fast non-destructive repair of digital circuits.

To help you take advantage of the usefulness of the IC Troubleshooters, HP has packaged them into kits which offer both ordering convenience, and cost savings. Also, applications information is available, such as AN 163-2, "New Techniques of Digital Troubleshooting", to help users derive maximum benefit from these instruments.

The table shows a series of typical node and gate faults and the combination of tools used to troubleshoot the circuit. As with all sophisticated measuring instruments, operator skill and circuit knowledge are key factors once the various clues or "bits" of information are obtained using the IC Troubleshooters.

To accomplish troubleshooting at the node and gate level, both stimulus (Pulser) and response (Probe, Tracer, Clip and Comparator) instruments are needed. Moreover, instruments with both voltage and current troubleshooting capability help isolate electrical faults where the precise physical location is hard to identify.

The HP 547A Current Tracer, the latest and most sophisticated of these troubleshooters, lets you "see" current flow on nodes and buses that otherwise appear stuck at one voltage level. Used with the HP 546A Pulser, stimulus-response testing is now also possible in the current domain.

### IC Troubleshooter Kits Ordering Information

Kit	H mm (in)	W mm (in)	D mm (in)	Net Wt kg (lbs, oz)	Ship Wt kg (lbs, oz)
HP 5011T	82.6 (3.25)	203 (8)	311 (12.25)	1.49 (3.5)	2.11 (4.11)
HP 5021A	64 (2.5)	146 (5.75)	298 (11.75)	0.51 (1.2)	0.62 (1.6)
HP 5022A	64 (2.5)	146 (5.75)	298 (11.75)	0.65 (1.7)	0.76 (1.11)
HP 5023A	225 (8.88)	200 (7.88)	337 (13.25)	1.63 (3.10)	2.19 (4.14)
HP 5024A	64 (2.5)	146 (5.75)	298 (11.75)	0.60 (1.5)	0.71 (1.9)

### Accessories Available

**HP 00545-60104:** Tip Kit for HP 545A Probe, and 546A Pulser **\$65** ☎

**HP 10526-60002:** Multi-pin Stimulus Kit for Logic Pulser **\$75**

**HP 10529-60006:** External Reference Kit for HP 10529A Comparator **\$440**

**HP 10541A:** Twenty blank reference boards for HP 10529A Comparator **\$170** ☎

**HP 10541B:** Twenty pre-programmed reference boards for HP 10529A Comparator **\$440** ☎

☎ For same day shipment, call HP DIRECT at 800-538-8787

### IC Troubleshooter Kits Selection Guide

HP MODEL	545A TTL/CMOS Probe	546A TTL/CMOS Pulser	547A TTL/CMOS Current Tracer	548A TTL/CMOS Clip	10529A TTL Comparator	PRICE
5011T Kit	X	X		X	X	\$2000 ☎
5021A Kit	X	X		X		\$910 ☎
5022A Kit	X	X	X	X		\$1530 ☎
5023A Kit	X	X	X	X	X	\$2600 ☎
5024A Kit	X	X	X			\$1220 ☎

☎ For same day shipment, call HP DIRECT 800-538-8787.

# COMPONENT MEASUREMENT

## General Information

### Impedance Measurement

Application Area	Component/Material Manufacturer		Component User	
	R&D and QA	Production	Incoming Inspection	R&D
Major Requirements	Verify that device has sufficient performance	Perform GO/NO-GO testing based on MIL, IEC, etc.	Evaluate devices/circuits under actual working conditions	
Required Measurement Functions	Multi-function/General Purpose Wide freq. range Auto freq. sweep Variable signal level & DC Bias Multi-parameter High accuracy and resolution	High Speed/Single Function High Speed Fixed frequency level & DC Bias Single parameter	Multi-function/General Purpose High frequency resolution Auto freq. sweep Variable signal level & DC Bias Multi-parameter High accuracy and resolution	
HP 4195A				
HP 4194A				
HP 4192A				
HP 4191A				
HP 4193A				
HP 4284A / 4285A				
HP 4274A / 4275A				
HP 4278A				
HP 4276A / 4277A				
HP 4279A				
HP 4261A / 4262A				
HP 4342A				
HP 4328A				
HP 4329A				

**Table 1 Component measurement applications and HP products**

Note: Refer to page 232 for complete information of the HP 4195A.

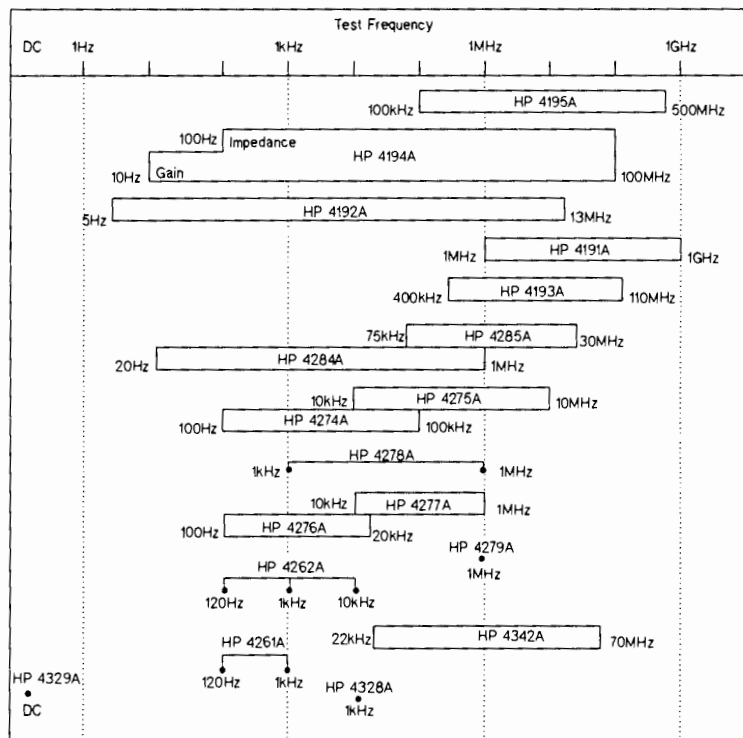

**Table 2 HP component measurement products vs. test frequency**

Note: Refer to page 232 for complete information of the HP 4195A.

### Component Measurement

An impedance-measuring instrument measures impedance characteristics of electronic components, materials and circuits. HP impedance instruments provide:

1. A broad product line, to fit each application;
2. Full evaluation of impedance characteristics under conditions of varying frequency, test-signal level and DC bias.
3. High-precision, high-resolution impedance measurement, with error correction for test-lead or test-fixture effects.

Impedance-measuring instruments can be divided into two general categories: LCR meters and impedance analyzers. The LCR meter primarily measures the inductance, capacitance and resistance of a test device. The impedance analyzer, in addition to all of the functions of the LCR meter, measures the impedance and phase of the test device, and makes detailed analysis of the impedance measurement.

The major applications of impedance-measurement instruments are in electronic-component materials manufacture and electronic equipment manufacture (electronic component users). Table 1 shows the type of evaluation and the functions required according to instrument application.

Impedance measurements can be divided into two general categories:

1. Tests of whether the test device functions properly under application conditions and
2. Tests under conditions stipulated by MIL or IEC standards.

When type 1 measurements are conducted in an R&D department, the purpose is to shorten development time through careful evaluation. Therefore, a multi-function, general-purpose instrument for the measurement of many characteristics is required, such as an impedance analyzer or high-resolution LCR meter.

Type 2 measurements are conducted for go/no-go tests in manufacturing or incoming inspection. The measurement data are fed back to vendors or manufacturing processes for correction and improvement. Because of volume, test costs must be minimized. Therefore, a high-speed, single-function instrument may be used. Sorting and interpreting test results may be required, so an LCR meter with a comparator option can be used.

Table 2 shows HP's line of instruments arranged according to measurement frequency and performance. Test frequencies of these instruments range from 5 Hz to 1 GHz, and some have fixed MIL/IEC standard frequencies between 1 kHz and 1 MHz.

Since the time that HP introduced the first digital LCR meter, the company has continued to create high-performance impedance-measurement instruments. Because of this effort, it is now possible for virtually anyone to make the most difficult impedance measurements with ease and great accuracy.

**Variety of available test fixtures and cables**

A variety of test fixtures and cables are available for the HP LCR meters for many applications. Figure 1 is a compatibility chart for the test fixtures and cables and HP's LCR meters. Refer to the individual LCR meter data sheet for details.

- \* 1: information given with cable length; connector type; recommended frequency for use; max. applicable dc voltage.
- \* 2: information given with recommended frequency for use; max. applicable dc voltage.
- \* 3: information given with cable length; recommended frequency for use; max. applicable dc voltage; (shape of UNKNOWN terminals).
- \* 4: a cable with 7 mm connectors required.

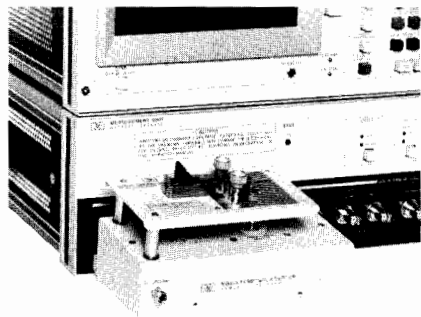

HP 16092A  
with HP 16085B

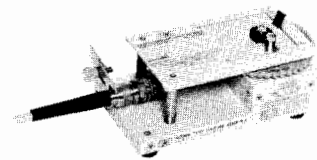

HP 16093A  
with HP 16099A

Note: Refer to the sections of the HP 41941A/B and 41951A for more information.

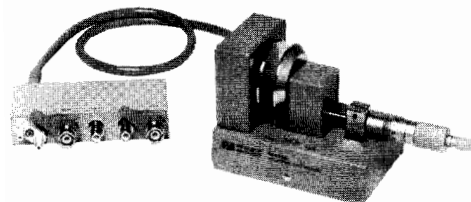

HP 16451B

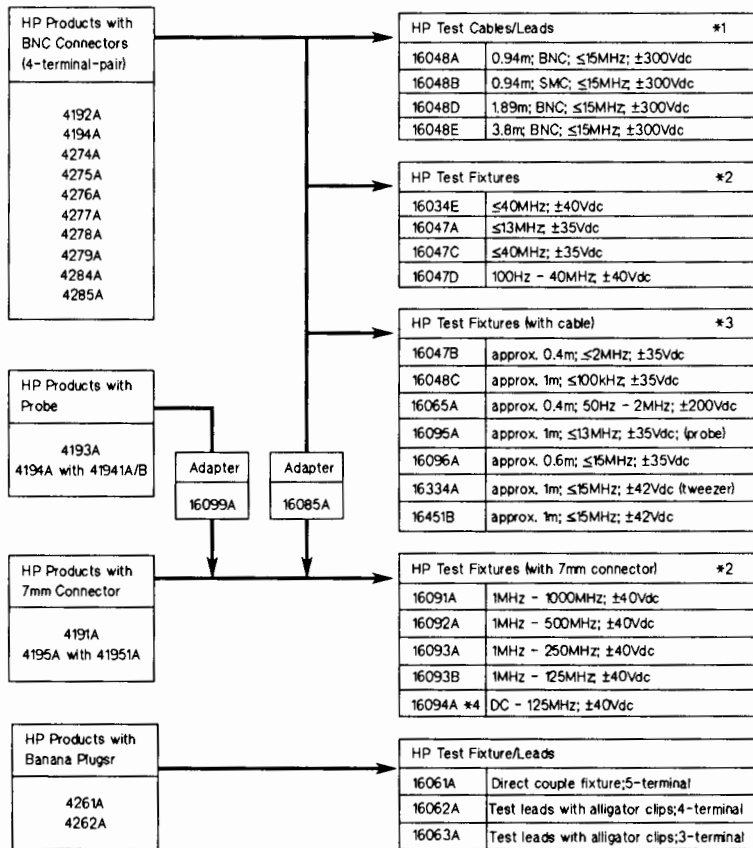
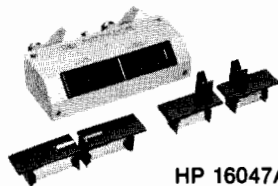
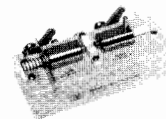

Figure 1. HP instruments vs. accessories



HP 16047A



HP 16034E



HP 16047C

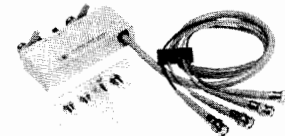

HP 16048A

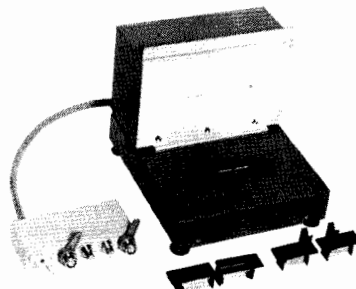

HP 16065A

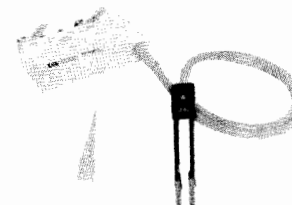

HP 16334A

# COMPONENT MEASUREMENT

## Impedance/Gain-Phase Analyzer

HP 4194A

- High Accuracy and Wide Range

Impedance Measurement:

100Hz to 40MHz, 0.1m $\Omega$  to 1.6M $\Omega$ , 0.17%  
10 kHz to 100 MHz, 0.1 $\Omega$  To 1M $\Omega$ , 1.5% when  
used with the HP 41941A/B

Gain-Phase Measurement:

10Hz to 100MHz, -107dBm to +15dBm, 0.1dB  
resolution

- Flexible Measurement, Computation and Analysis Capabilities on a Color Graphic Display
- Fully Programmable

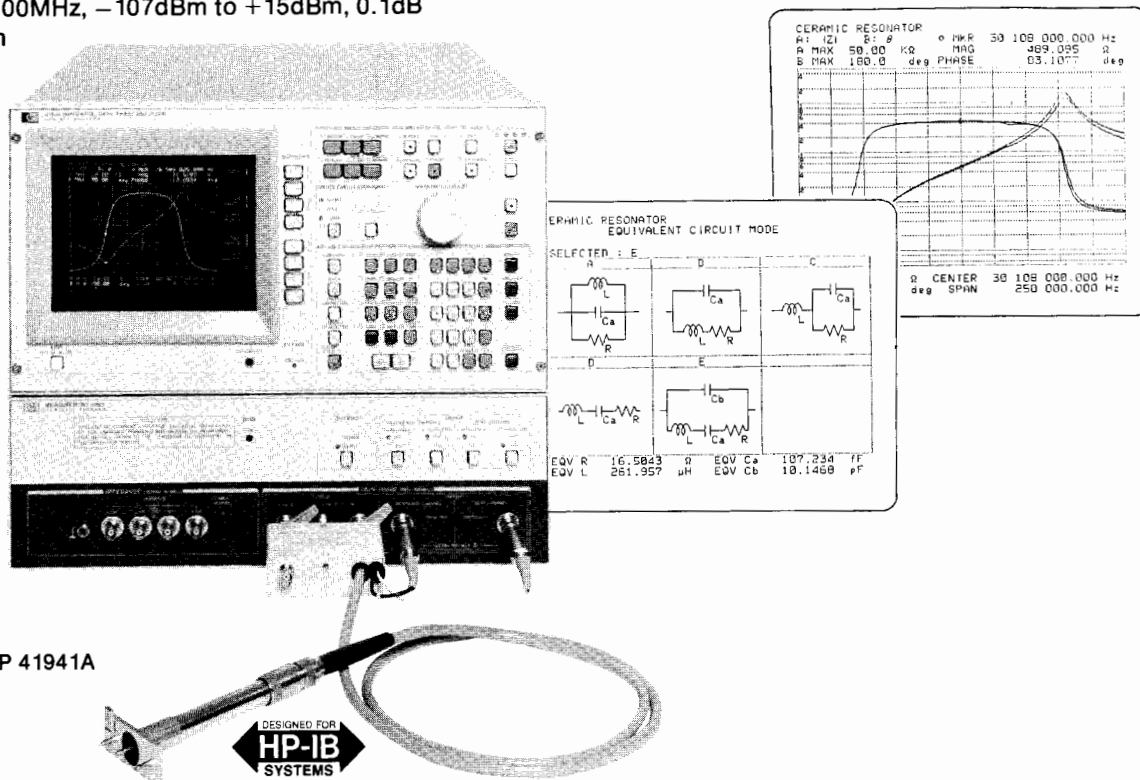

HP 4194A with HP 41941A

### Description

The HP 4194A Impedance/Gain-Phase Analyzer is an integrated solution for efficient measurement and analysis or go/no-go testing of components and circuits. Detailed impedance and transmission characteristics including secondary parameter derivations can be simply and quickly evaluated or tested. The HP 4194A can contribute to improving engineering productivity and reducing test cost. The analyzer is flexible and has wide measurement capabilities in both impedance and transmission measurements, plus it is fully programmable using Auto Sequence Programming (ASP). Desired measurements and computations, including graphics analysis, can be programmed simply by storing front panel keystroke operations, allowing you to customize measurement, computation and analysis functions. The HP 4194A also features high accuracy and error elimination functions to ensure reliable measurements.

### Wide Range Accurate Measurement

Featuring a wide test frequency range — 100Hz to 40MHz for impedance measurements (10kHz to 100MHz when using the HP 41941A/B Impedance Probe Kit) and 10Hz to 100MHz for gain-phase measurements — the HP 4194A satisfies a wide spectrum of needs. Realistic device characteristics can be analyzed under actual operating conditions by varying the test frequency, test signal level, and dc bias. The HP 4194's high degree of measurement accuracy — 0.17% for impedance measurements (1.5% when using the HP 41941A/B) with an amplitude ratio of 0.1 dB — ensures that you'll improve the quality of your test devices.

### Quick Analysis

The HP 4194A makes high speed measurements, (approximately 3.7ms per point), displays results on a color CRT, and performs parameter analysis of components and circuits quickly and efficiently;

substantially reducing development and evaluation time. The analysis function not only provides you with impedance and transmission characteristics, but also allows you to determine secondary parameters. Using the marker and line cursor functions, you can obtain the resonating frequency of resonators and the pass band width of band pass filters quickly.

### Equivalent Circuit Analysis Function

Using the HP 4194A's Equivalent Circuit Analysis Function, you can easily and quickly obtain those equivalent circuit constants that, until now, required a number of time-consuming, complicated calculations. By using measured values, this unique function can approximate the circuit constant values of five circuit models. For example, a resonator's equivalent circuit elements or a coil's self inductance, lead resistance, and stray capacitance can be easily obtained.

The equivalent Circuit Analysis function also simulates the frequency characteristics of components by using derived circuit values or values you specify. By using approximation and simulation, you can compare design values to measurement values, and thereby, improve component design efficiency.

### Auto Sequence Program (ASP)

The HP 4194A's ASP function, an internal programming feature, allows you to control all HP 4194A operations (measurement, display, and analysis) without the need for an external computer. By using ASP and actual measurement values, you can readily calculate many secondary parameters that you may need to evaluate. You can

then use the HP 4194A's powerful analysis functions to analyze these calculated parameters.

You can also use ASP to enhance such HP 4194A functions as alternate sweep, sweep timing control, and marker tracking. Because ASP eliminates the need for external controller, thereby eliminating data transfer time, the HP 4194A can quickly and efficiently perform production line go/no-go testing of components such as resonators and filters. All these features combine to increase your engineering and manufacturing productivity.

### Increased Capabilities With The HP 41941A/B Impedance Probe Kit

When using the HP 4194A with the HP 41941A/B Impedance Probe Kit, you can perform reliable impedance evaluations up to 100MHz. Measurement errors due to residual impedance and stray admittance are eliminated by using the calibration standards furnished with the HP 41941A/B and the HP 4194A's automatic calibration function. This makes it possible to make highly accurate measurements (basic measurement accuracy 1.5 to 3%) over a wide measurement range of 100mΩ to 1MΩ. Calibration accuracy is guaranteed to the tips of the HP 41941A (1.5m) and HP 41941B (3m) impedance probes.

The HP 41941A/B can be used as a grounded probe to evaluate the impedance of in-circuit components such as printed circuit patterns, and the input/output impedance of circuits. In addition, you can connect an external dc bias source directly to the HP 41941A/B to perform dc biased measurements up to ±150V/0.5A, to measure the dc characteristics of inductors, capacitors, materials, and semiconductors. To perform swept dc bias measurements, use the HP 4194A's ±40V internal dc bias source.

### Specifications

#### Impedance Measurements

**Measurement Parameters:** |Z|, |Y|, θ, R, X, G, B, L, C, D, Q. 20 parameter combinations are available.

**Test Frequency:** 100 Hz - 40 MHz (CABLE LENGTH: 0m), 100Hz - 15 MHz (CABLE LENGTH: 1m), 1mHz resolution.

**OSC Level:** 10mV - 1Vrms (≤10MHz), 10mV - 0.5Vrms (>10MHz) (UNKNOWN terminal open), 3 digit resolution

**DC Bias:** 0 - ±40V, 10mV resolution

**Measurement terminal:** 4 - terminal pair configuration

**Measurement Range and Maximum Resolution:**

Measurement Parameter	Range	Max Resolution
Z , R, X	10mΩ to 100MΩ	100μΩ
Y , G, B	10nS to 100S	1nS
θ	± 180°	0.01°
L	1nH to 100kH	10pH
C	10fF to 0.1F	0.1fF
D	0.001 to 10	0.0001
Q	0.1 to 1000	0.1

**Basic Measurement Accuracy:** 0.17%

**Level Monitor:**

#### Gain-Phase Measurements

**Measurement Parameters:** Tch/Rch (dB, Linear Ratio), Tch, Rch (V, dBm, dBV), θ (degree, rad), τ

Tch= Test Channel, Rch= Reference Channel, τ = Group Delay

**Measurement Frequency:** 10Hz - 100MHz, 1mHz resolution

**Aperture Frequency Range (Group Delay Measurements):** 0.5% - 100% of frequency span

**OSC Level:** -65dBm - +15dBm, 0.1dB resolution

**Measurement Range:**

**Tch/Rch:** 0 - ±120dB, 0.001dB resolution

**Tch, Rch:** -107dBm - -5dBm (0dB Attenuator)  
-87dBm - +15dBm (20 dB Attenuator)  
0.001dB resolution

θ: ±180° (can display phase continuously with the phase scale expansion function), 0.01° resolution

τ: 0.1ns - 1s, 0.1ns resolution

**Basic Measurement Accuracy:**

**Tch/Rch:** 0.1dB, 0.5°

**Tch, Rch:** 0.35dBm

θ: 0.5°

**Level Monitor**

#### Impedance Measurements using the HP 41941A/B

The specifications listed below are for the HP 4194A when used with the HP 41941A/B.

**Frequency Range:** 10 kHz - 100 MHz, 1 mHz resolution

**OSC Level:** Opt. 350: 10 mV - 1.28 Vrms

Opt. 375: 10 mV - 1.54 Vrms

**DC Bias:** Internal: ± 40V, ± 20 mA

External: ± 150V, ± 500 mA, max 25 W

**Measurement Range:** 100 mΩ - 1 MΩ

**Basic Measurement Accuracy:**

± 1.5% to 3% (≥ 100 kHz), ±3% to 6% (< 100 kHz)

**Cable Length:** HP 41941A: 1.5 m, HP 41941B: 3 m

### Common Specifications

**Trigger Mode:** Internal, External and Manual

**Sweep Capability:**

**Sweep Parameter:** Frequency, OSC Level, DC Bias (impedance measurements only)

**Entry:** START/STOP or CENTER/SPAN

**Sweep Type:** LIN, LOG, ZERO SPAN (DC Bias: LIN or ZERO SPAN only)

**Number of Measurement Points:** 2 to 401 points

**Sweep Functions:** Partial Sweep, Expand Markers Sweep, Program Points Measurement

### Display

**CRT:** 7.5 inch color CRT

**Display Mode:** Rectangular (X- A & B), Rectangular (A - B), Table

**Display Control:** Autoscale, Superimpose and Storage

### Analysis

**Maker:** Single, Delta, Double Makers

**Line-Cursor:** Line-Cursor, Delta-Line Cursor

**Equivalent Circuit Function:** Approximation, Simulation

**Arithmetic Operation**

**Data Resister Manipulation:** Use arithmetic operations and functions to manipulate data registers.

**GO/No-Go Limits**

### Programming

**Auto Sequence Program (ASP):** Control the HP 4194A's operation with an internal program language. ASP Programs can be entered using the front panel keys or downloaded from HP-IB.

**Program Memory Size:** 20kBytes of non-volatile memory

**Copy:** Dump, Plot, Print Mode

### General Specifications

**Operating Temperature and Humidity:** 0°C - 40°C (HP 41941A/B: -20 - +65°C), ≤95%RH at 40°C

**Storage Temperature:** -30°C - +60°C (HP 41941A/B: -40 - +65°C)

**Safety:** Based on IEC - 348, UL - 1244

**Power:** 100, 120, 220V ±10%, 240V - 10% + 5%, 48 - 66Hz, 400VA (max)

**Dimensions:** 425 (W) x 375 (H) x 620(D) mm

**Weight:** Approximately 37kg (net)

### Reference Data

**Typical Measurement Speed:**

**Impedance:** Approximately 3.7ms/point

**Gain-Phase:** Approximately 3.5ms/point

**Impedance when used with the HP 41941A/B:** Approximately 6 ms/point

### Accessories Furnished

**HP 18047D:** Direct Coupled Test Fixture

**HP 8120-1838:** 30cm BNC Cable (2ea) (OPT.350)

**HP 04194-61640:** 30cm BNC Cable (2ea) (OPT.375)

**HP 8120-1839:** 60cm NNC Cable (OPT.350)

**HP 04194-61641:** 60cm NNC Cable (OPT.375)

**HP 1250-0080:** BNC Adapter

### Accessories Available

Refer to page 301

### Ordering Information

**4194A Impedance/Gain-Phase Analyzer**

**Price**

**Opt 350\*:** 50 Ohm System

\$23,200

**Opt 375\*:** 75 Ohm System

\$0

**Opt W30:** Extended repair service. See page 723

+\$455

**Opt 001:** High Stability Frequency Reference

+\$865

**HP 41941A\* Impedance Probe Kit (1.5m)**

\$1760

**HP 41941B\* Impedance Probe Kit (3 m)**

\$1760

\*Must select either OPT.350 or 375

# COMPONENT MEASUREMENT

## LF Impedance Analyzer (5 Hz to 13 MHz)

HP 4192A

- 5 Hz to 13 MHz variable measuring frequency
- Gain-phase measurement: amplitude, phase, group delay
- Floating or grounded devices
- Impedance measurement:  $|Z|$  •  $|Y|$  •  $\theta$  • R • X • G • B • L • C • D • Q •  $\Delta$  •  $\Delta\%$
- Standard HP-IB

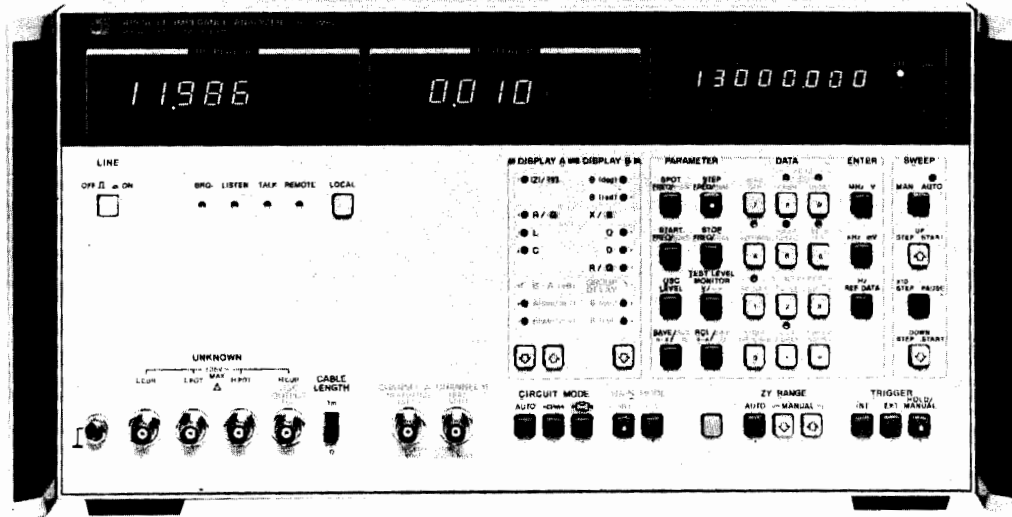

HP 4192A (shown with Opt. 907 handles)



### Description

The HP 4192A LF Impedance Analyzer performs both network analysis and impedance analysis on devices such as telecommunication filters, audio/video electronic circuits, and basic electronic components. Both floating and grounded devices can be tested.

### Automatic Swept Frequency Measurement of All Impedance Parameters

The HP 4192A can measure 11 impedance parameters ( $|Z|$ ,  $|Y|$ ,  $\theta$ , R, X, G, B, L, C, D, Q) over a wide range  $|Z|$ : 0.1 m $\Omega$  to 1 M $\Omega$ ;  $|Y|$ : 1 nS to 10 S).

The built-in frequency synthesizer can be set from 5 Hz to 13 MHz with a maximum resolution of 1 mHz. This feature allows accurate characterization of high Q devices such as crystals. Test signal level is variable from 5 mV to 1.1 V with 1 mV resolution. Also, an internal dc bias voltage source provides  $\pm 35$  V at 10 mV increments. Thus, the HP 4192A can evaluate components and entire circuits near actual operating conditions.

### Specifications (complete specifications on data sheet)

#### Measuring signal ( $23 \pm 5^\circ\text{C}$ )

**Frequency range:** 5 Hz to 13 MHz

**Frequency step:** 0.001 Hz (5 Hz to 10 kHz), 0.01 Hz (10 kHz to 100 kHz), 0.1 Hz (100 kHz to 1 MHz), 1 Hz (1 MHz to 13 MHz).

**Frequency accuracy:**  $\pm 50$  ppm

**OSC level:** 5 mV to 1.1 Vrms variable into 50  $\Omega$  (amplitude-phase measurement) or open circuit (impedance measurement).

**OSC level step:** 1 mV (5 mV to 100 mV), 5 mV (100 mV to 1.1 V).

**OSC level accuracy:** 5 Hz to 1 MHz:  $\pm((5 + 10/f)\%)$  of setting + 2 mV where f is in Hz. 1 MHz to 13 MHz:  $\pm((4 + 1.5 \times F)\%)$  of setting + 2 mV where F is in MHz.

**Level monitor** (impedance measurement): current through or voltage across sample can be monitored

**Control:** spot and sweep via front panel or HP-IB

#### Measuring Mode

**Spot measurement:** at specific frequency (or dc bias)

**Swept measurement:** manual or automatic sweep from START to STOP frequency (or dc bias) at selected STEP frequency (or dc bias) rate

**Sweep mode:** linear or logarithmic (frequency only)

**Recorder outputs:** output dc voltage proportional to each measured value, and frequency or dc bias.

**Maximum output voltage:**  $\pm 1$  V

**Output voltage accuracy:**  $\pm(0.5\%$  of voltage + 20 mV)

**Key status memory:** 5 sets of measuring conditions can be stored and recalled at any time.

**HP-IB data output and remote control:** standard

**Self-test:** automatic introspective testing

**Trigger:** internal, external, manual or HP-IB

### Amplitude—Phase Measurement

**Parameter measured:** relative amplitude B-A (dB) and phase  $\theta$  (degrees or radians), B-A and group delay, absolute amplitude A (dBm or dBV) or B (dBm or dBV), and deviation ( $\Delta$ ,  $\Delta\%$ ) of all parameters

**Reference amplitude:** 0 dBV = 1 Vrms, 0 dBm = 1 mW (with 50  $\Omega$  termination)

**OSC output resistance:** 50  $\Omega$

**Channels A and B:** input impedance: 1 M $\Omega \pm 2\%$ , shunt capacitance: 25 pF  $\pm 5$  pF

### Display Range and Resolution

**B-A:** 0 to  $\pm 100$  dB, 0.001 dB (0 to  $\pm 20$  dB), 0.01 dB ( $\pm 20$  to  $\pm 100$  dB)

$\theta$ : 0 to  $\pm 180^\circ$ , 0.01 $^\circ$

**Group delay:** 0.1 ns to 19 s, max. resolution  $4\frac{1}{2}$  digits

**A or B:** +0.8 to  $-100$  dBV, 0.001 dB ( $> -20$  dB), 0.01 dB ( $\leq -20$  dB), +13.8 to  $-87$  dBm, 0.001 dB ( $> -20$  dBm), 0.01 dB ( $\leq -20$  dBm)

**Measuring accuracy ( $23 \pm 5^\circ\text{C}$ ):** specified at BNC unknown terminals after 30 minute warmup (test speed: normal or average)

### B-A (relative amplitude) and $\theta$ (phase) Measurement

Determined by sum of channel A and B accuracies given below (accuracy of each channel changes according to absolute input level)

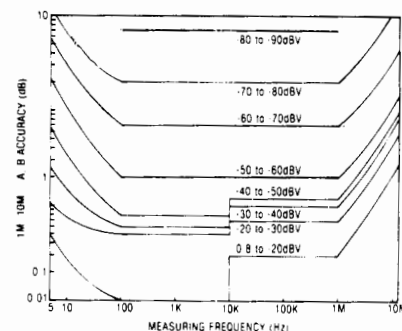

FIGURE 1. GAIN MEASUREMENT ACCURACY



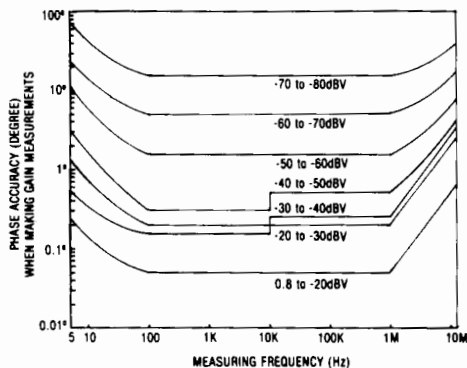

FIGURE 2: PHASE ACCURACY WHEN MAKING GAIN MEASUREMENTS

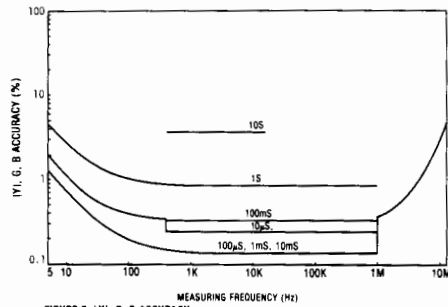

FIGURE 5: |Y|, G, B ACCURACY

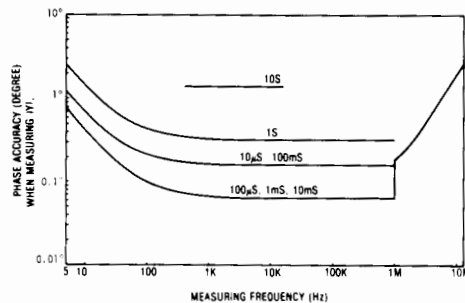

FIGURE 8: PHASE ACCURACY WHEN MEASURING |Y|

**Impedance Measurement**

**Parameter measured:**  $|Z| - \theta$ ,  $|Y| - \theta$ , R-X, G-B, L-D • Q • R • G, C-D • Q • R • G and deviation ( $\Delta$ ,  $\Delta\%$ ) of all parameters

**Display:** 4½ digits, max. display 12999 counts, 19999 for L & C.

**Circuit mode:** series equivalent circuit (—□—) and parallel equivalent circuit (—□—). Automatic selection available.

**Auto ZERO adjustment:** automatic normalization of the readout offset due to residuals of the test fixture by pushbutton operation (at spot frequency)

**Measuring range and accuracy (23 ± 5°C):** specified at BNC unknown terminals after 30 minute warmup when OSC level is more than 0.1 V and when auto ZERO adjust is performed (test speed: normal or average). Accuracy given below is only valid when the measured value is equal to full scale of each range.

**|Z| -  $\theta$ , R - X measurement:** range:  $|Z|$ , R, X: 0.1 m $\Omega$  to 1.2999 M $\Omega$ ;  $\theta$ : -180.00° to +180.00°. Accuracy: R accuracy (D ≥ 10); X accuracy (D < 1)

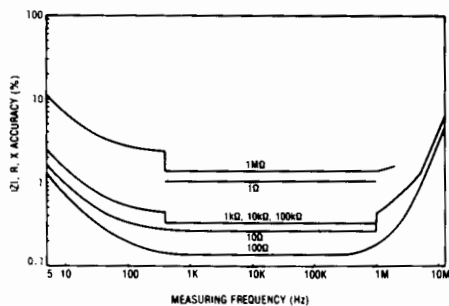

FIGURE 3: |Z|, R, X ACCURACY

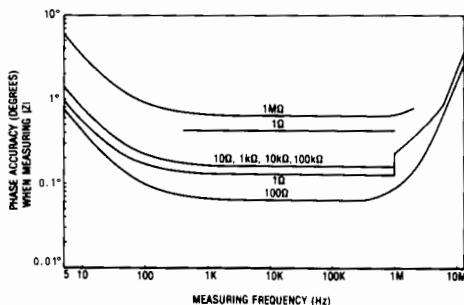

FIGURE 4: PHASE ACCURACY WHEN MEASURING |Z|

**|Y| -  $\theta$ , G - B measurement:** range:  $|Y|$ , G, B: 1 nS to 12.999 S;  $\theta$ : -180.00° to +180.00°. Accuracy: G accuracy (D > 1); B accuracy (D ≤ 0.1).

**L - D • Q, C - D • Q measurement:** (automatically calculated from measured Z/Y values)

Parameter	Measuring Range*	Basic Accuracy
L	0.01 nH to 1000 H	0.27%
C	0.1fF to 199** mF	0.15%
D(1/Q)	0.0001 to 19.999	0.001 (C-measurement) 0.003 (L-measurement)

\*Varies with measuring frequency except for D(1/Q)

\*\*Accuracy of C ranges over 100 mF is not specified.

**Internal dc bias:** standard (impedance measurement only)

**Voltage range:** -35 V to +35 V, 10 mV step

**Setting accuracy (23 ± 5°C):** 0.5% of setting + 5 mV

**Bias control:** spot and swept, using front panel controls or HP-IB

**General**

**Measuring Time (high speed mode)**

**B-A and  $\theta$ , A or B:** 88 to 127 ms (≥ 400 Hz)

**Impedance parameters:** 58 to 91 ms (≥ 1 kHz)

**Test Level Monitor Range (impedance measurement)**

**Voltage:** 5 mV to 1.1 V

**Current:** 1  $\mu$ A to 11 mA

**Operating temperature:** 0 to 55°C, ≤ 95% RH at 40°C

**Power:** 100, 120, 220 V ± 10%, 240 V + 5% to -10%, 48 to 66 Hz, 150 VA max.

**Size:** 425.5 mm W x 235 mm H x 615 mm D (16.75" x 9" x 22.6").

**Weight:** approx. 19 kg (41.9 lb)

**Furnished accessories and parts:** HP 16047A test fixture, HP 11048C 50  $\Omega$  feed thru terminations (2 ea.), power splitter, HP 11170A BNC cables (2 ea.), BNC adapter

**Ordering Information**

HP 4192A LF Impedance Analyzer

**Price**

\$16,000

**Accessories**

HP 16095A Probe Fixture

\$865

HP 16096A 2-port Component Test Fixture

\$1,425

HP 16097A Accessory Kit

\$2,240

HP 16047C Test Fixture

\$310

HP 16048A Test Leads (BNC connector)

\$330

HP 16048C Test Leads with alligator clip

\$430

Refer To Page 301

☎ For same-day shipment, call HP DIRECT at 800-538-8787.

# COMPONENT MEASUREMENT

## RF Impedance Analyzer

HP 4191A

- 1-1000 MHz variable test frequency with sweep capability
- Direct reading of  $|Z| - \theta$ ,  $|Y| - \theta$ ,  $|\Gamma| - \theta$ ;  
 $L \cdot C - R \cdot G \cdot D \cdot Q$   
 $R - X, G - B, \Gamma_x - \Gamma_y$

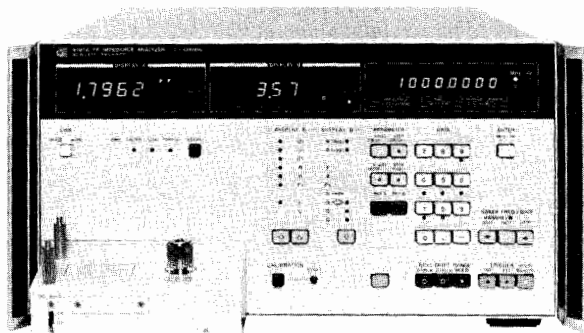

HP 4191A (Shown with Opt 907 Handles)



### Description

The HP 4191A RF Impedance Analyzer measures 14 parameters with a maximum resolution of  $4\frac{1}{2}$  digits. The internal synthesizer provides variable frequencies from 1 MHz through 1000 MHz covering the UHF, VHF and video bands with automatic sweep capability. An internal dc bias supply with auto sweep function covers the voltage range of  $\pm 40$  V in 10 mV steps.

The HP 4191A permits reliable measurements over a wide measuring range. Its outstanding repeatability, frequency response and accuracy are made possible by unique error correction capability and specially designed test fixtures. These features allow the HP 4191A to be used in evaluation of electronic materials, components and circuitry.

The internal synthesizer provides a maximum resolution of 100 Hz (Opt 002) with an accuracy of 3 ppm, allowing small changes in the resonant frequency of the device under test to be easily detected. The swept frequency capability aids in the analysis of frequency characteristics of the device.

Two complete front panel settings (parameter selection and the sweep control) can be stored in a non-volatile memory and recalled at any time with a single key operation. This, together with the standard HP-IB interface, makes the HP 4191A extremely efficient either as a stand-alone or systems instrument.

These unique features permit very wide applications in: (1) semiconductor testing such as surface state evaluation at high frequencies (C-V/G-V and conductance  $G/\omega-\omega$  characteristics), and the input/output impedance evaluation of diodes and transistors, (2) resonator, filter, and magnetic and dielectric materials testing, (3) evaluation of LCR components such as high frequency chip and leaded components, and (4) testing of communications related components such as cables, connectors, etc.

### Specifications (Refer to data sheet for complete specifications)

**Parameter measured:**  $|Z| - \theta$ ,  $|Y| - \theta$ ,  $|\Gamma| - \theta$ ,  $R - X$ ,  $G - B$ ,  $\Gamma_x - \Gamma_y$   
 $L - R \cdot G \cdot D \cdot Q$ ,  $C - R \cdot G \cdot D \cdot Q$

**Display:**  $4\frac{1}{2}$  digit, max display 19999 counts

**Deviation Measurement** (deviation from stored reference)

$\Delta$ : -19999 to +19999 counts  $\Delta\%$ : -1999.9 to +1999.9%

**Measuring Signal** ( $23 \pm 5^\circ\text{C}$ )

**Frequency range:** 1 MHz to 1000 MHz

**Frequency step:**

Standard: 100 kHz, 1-500 MHz 200 kHz, 500-1000 MHz

Opt 002: 100 Hz, 1-500 MHz 200 Hz, 500-1000 MHz

**Frequency accuracy:**  $\pm 3$  ppm

**Signal level (into 50 $\Omega$ ):** -20  $\pm 3$  dBm

**Frequency control:** spot and swept

- High resolution— $4\frac{1}{2}$  digit max
- Wide measuring range—1 m – 100 k ( $|Z|$ )
- Versatile, easy-to-use test fixtures

### Measuring Mode

**Spot measurement:** at specific frequency (or dc bias)

**Swept measurement:** manual or automatic sweep from start to stop frequency (or dc bias) at step frequency (or dc bias) rate in linear or logarithmic form.

### Auto Calibration

Automatic error compensation referenced to connected terminations (0  $\Omega$ , 50  $\Omega$ , 0 S), 51 frequencies including start and stop frequencies.

**Electrical length compensation:** automatic compensation for electrical length of test fixtures. (Range: 0 to 99.99 cm).

**Internal dc Bias:** Voltage range: -40 to +40 V, 10 mV step

Setting accuracy: 0.1% of setting +10 mV

Bias control: spot and swept

**External dc Bias:** Voltage range: -40 to +40 V

Max allowable current: 100 mA

**Key status memory:** 2 sets of measuring conditions can be stored and recalled at any time. These conditions are kept in storage even when LINE is turned off.

**Ranging:** Auto/Range hold **Trigger:** Internal, External or Manual

**Self-test:** automatic internal program test

**HP-IB data output and remote control:** standard

**$|\Gamma| - \theta/\Gamma_x - \Gamma_y$  Measurement**

**Measuring Range:**  $|\Gamma|$ ,  $\Gamma_x$ ,  $\Gamma_y$ : 0.0001 to 1.0000

$\theta$ :  $0^\circ$  to  $\pm 180.00^\circ$  (0 to  $\pm \pi$  rad.)

$|\Gamma|, \Gamma_x, \Gamma_y$  resolution: 0.0001

### Reference Data (Not Specified)

**Temperature coefficient for  $|\Gamma|$ :** 0.0001/ $^\circ\text{C}$  ( $23 \pm 5^\circ\text{C}$ )

**Measuring time:** <800 ms or <250 ms (high speed mode)

**Frequency switching time:**  $\leq 200$  ms

$|\Gamma|$ ,  $\Gamma_x$ ,  $\Gamma_y$ , ACCURACY

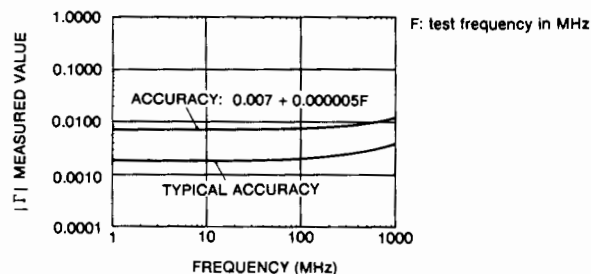

### General

**Temperature:** 0 - 55 $^\circ\text{C}$ , < 95% RH

**Power:** 100, 120, 220 V  $\pm 10\%$ , 240 V + 5% - 10%, 48 - 66 Hz, 150 VA max.

**Size:** 425.5 mm W x 230 H x 574 mm D (16.75" x 9" x 22.6").

**Weight:** approx. 24 kg (52.8 lb)

**Accessories furnished:** accessory case (with reference terminations included).

### Accessories Available

Accessories Available	Prices
HP 16091A Coaxial Test Fixture	\$570
HP 16092A Spring Clip Test Fixture	\$550
HP 16093A Binding Post Test Fixture	\$224
HP 16093B Binding Post Test Fixture	\$238
HP 16094A Probe Fixture	\$208

Refer to page 301.

### Ordering Information

HP 4191A RF Impedance Analyser	\$19,950
Opt W30 Extended repair service. See page 723.	+\$465
002: 100 Hz/200 Hz resolution synthesizer	+\$2,140
004: Recorder Outputs	+\$560

# COMPONENT MEASUREMENT

## Vector Impedance Meter (400 kHz to 110 MHz)

307

HP 4193A

- 400 kHz to 110 MHz spot or swept frequency
- Measure impedance magnitude (10 mΩ to 120 kΩ) and phase (−180.0° to +180.0°)
- Test components in-circuit and out-of-circuit

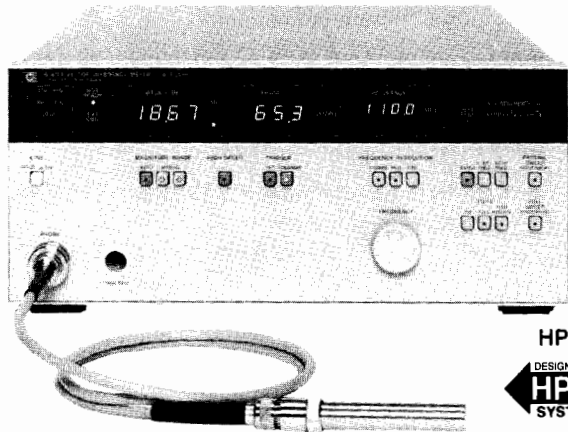

HP 4193A



### HP 4193A Vector Impedance Meter

The HP 4193A Vector Impedance Meter measures impedance magnitude and phase. An internal oscillator provides test signals from 400 kHz to 110.0 MHz. The test signal is constant current between 10 μA and 100 μA, depending on |Z| range.

#### Reliable and Accurate Impedance Measurement

The HP 4193A can measure and display impedance magnitudes from 10 mΩ to 120 kΩ. Impedance phase is displayed from +180.0° to −180.0°. Accuracy is as good as 3.0% of reading (magnitude) and 3.2° (phase).

Also, the HP 4193A's 3½ digit resolution makes it easy to see small changes in measurement results during adjustment procedures, for example.

#### Frequency Sweep for Complex Component Testing

When testing complex components like ceramic resonators, it is useful (1) to sweep frequency to get the big picture and (2) identify critical impedance points such as the series resonant point. This requires both swept measurement and measurements at individual "spot" frequencies. The HP 4193A can do both.

The HP 4193A can be tuned to any individual frequency from 400 kHz to 110.0 MHz with maximum resolution of 1 kHz. If greater frequency resolution is required, it can be provided by connecting an external synthesized source such as the HP 3335A or HP 8656B to the HP 4193A EXT OSC input.

Flexible internal frequency sweep is an exciting HP 4193A feature. Frequency can be swept linearly over any portion of the HP 4193A frequency range—or swept logarithmically over the entire 400 kHz to 110.0 MHz range.

#### Test In-Circuit and Out-of-Circuit Components

Several test fixtures help adapt the HP 4193A to your device under test. For example, the handy L-ground probe is useful for in-circuit testing. The HP 16099A Test Fixture Adapter and three associated fixtures help connect to out-of-circuit devices of various sizes and shapes.

#### Specifications (Refer to data sheet for complete specifications)

##### Test Signal Output Specifications

Test signal is output from the furnished low-ground probe.

**Frequency range:** 400 kHz to 110.0 MHz

##### Frequency Resolution

**400 kHz to 9.999 MHz:** 1 kHz resolution

**10.00 MHz to 99.99 MHz:** 10 kHz resolution

**100.0 MHz to 110.0 MHz:** 100 kHz resolution

**Frequency accuracy:** ±0.01% of setting after calibration.

**Frequency stability:** ±100 ppm per month (0 to 55 °C)

##### Frequency Control

**Spot:** spot frequency is set using coarse, medium and fine controls

**Full sweep:** logarithmic sweep at 43 points over full range of 400 kHz to 110 MHz

- Fixtures include low-grounded probe, spring clip fixture and binding post fixture
- Standard HP-IB and analog outputs

**Partial sweep:** linear sweep from selected START to STOP frequency. Number of steps is selected as 100, 1000 or "HIGH RESOLN". When "HIGH RESOLN" steps are selected, the operator must also select "coarse", "medium" or "fine" resolution.

**EXT OSC:** increase frequency resolution by connecting an external frequency synthesizer.

#### Impedance Measurement Specifications

**Input configuration:** low-grounded probe (furnished)

**Digital display of impedance:** 3½ digits

|Z|: 0 to 1999 counts (0 to 120 counts on 100 kΩ range)

∅: −1800 to +1800 counts (−180 to +180 counts on 100 kΩ range)

**Measurement trigger:** internal, external, and manual

**Measurement range control:** auto, hold, and manual

##### Measurement Range

|Z|: Five decade ranges: 10 Ω, 100 Ω, 1 kΩ, 10 kΩ, 100 kΩ

minimum |Z| (sensitivity): 10 mΩ

maximum |Z|: 120 kΩ

∅: One range: −180.0° to +180.0°

#### Reference Data

##### Test Signal Output

**Frequency settling time:** 5 ms to 400 ms. Best case is when (Δf/f)% is less than 10% (below 10 MHz) and less than 1% (above 10 MHz).

##### Signal Purity

**Spurious:** −60 dBc (dBc is dB below carrier)

**Harmonics:** −30 dBc

**Residual FM:** measured in a 100 Hz band centered on the carrier

**1 MHz to 110 MHz:** 100 Hz p-pFM

**Test level:** constant current source

##### Impedance Measurement

**Residual Impedance of Probe** (at probe tip)

**Resistance:** ≤0.55 Ω

**Inductance:** ≤(4.9 + 10/f) nH where f is measuring frequency in MHz

**Parallel Capacitance:** ≤0.11 pF

**Measuring speed:** assumes range is fixed; recorder output is OFF

**HI SPEED:** approximately 150 ms per measurement

**NORMAL:** approximately 1 s per measurement

**Ranging time:** approximately 1.2s

**Temperature coefficient** at 23°C ± 5°C

|Z|: 2 mΩ/°C, ∅: 0.02°/°C

#### General

**Operating temperature/humidity:** 0 to 55°C, ≤95% RH @ 40°C.

Note that measurement error in 0°C to 55°C temperature range is typically double the error in the 23°C ± 5°C range.

**Power:** 100/120/220 V ±10%, 240 V −10% to +5%, 48 to 66 Hz, 150 VA max

**Size:** 426 mm W x 178 mm H x 498 mm D, (16.75" x 7" x 19.6").

**Weight:** 18 kg (40 lb)

**Accessories furnished:** low-ground probe kit includes probe, spare pins, spare clips, BNC adapter, component mounting adapter, probe socket and accessory case.

#### Ordering Information

HP 4193A Vector Impedance Meter

**Price**

\$10,500

##### Accessories

HP 16099A Test Fixture Adapter (used with HP 16092A and HP 16093A/B)

\$500 ☎

HP 16092A Spring Clip Fixture (used with HP 16099A)

\$550 ☎

HP 16093A Binding Post Fixture (used with HP 16099A)

\$224 ☎

HP 16093B Binding Post Fixture (used with HP 16099A)

\$238 ☎

Refer to page 301.

☎ For same-day shipment, call HP DIRECT at 800-538-8787.

# COMPONENT MEASUREMENT

## Precision LCR Meters

HP 4284A, 4285A

- 20Hz to 1MHz, with over 8600 test frequencies
- 0.05% basic accuracy, 6-digit resolution
- Test signal level (Opt.001): 5mV to 20Vrms, 50 $\mu$ A to 200mArms
- 10-bin component sorting - comparator
- 75kHz to 30MHz in 100Hz steps
- 0.1% basic accuracy
- High speed measurements: 30ms/meas
- List sweep measurement capability

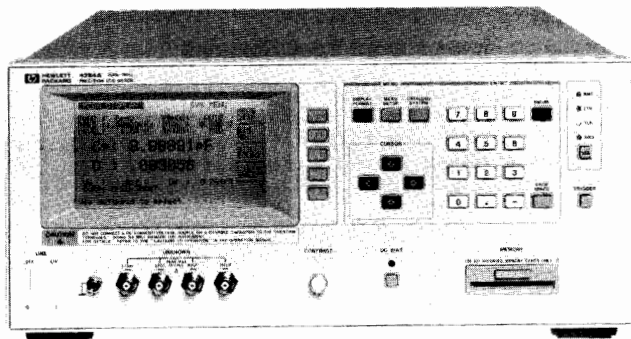

HP 4284A

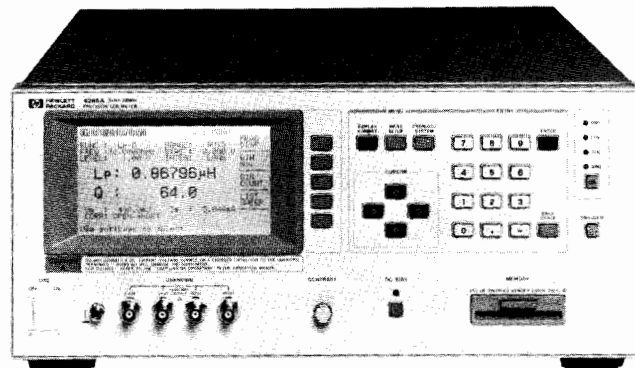

HP 4285A



### HP 4284A, HP 4285A Precision LCR Meters

The HP 4284A and HP 4285A precision LCR meters are cost-effective solutions for component and material measurement, which can be used to improve component quality by providing an accurate, high-throughput test solution. The wide 20Hz to 1MHz test frequency range and superior test signal performance allow the HP 4284A to test components to the most commonly used test standards, such as IEC/MIL standards, and under conditions which simulate the intended application. For demanding RF component tests, the HP 4285A offers a higher test frequency range, from 75kHz to 30MHz. Whether in R&D, production, quality assurance, or incoming inspection, the HP 4284A and HP 4285A will meet all of your LCR meter test and measurement requirements.

### Wide Range of Test Signal and dc Bias

The test signal (voltage/current) is variable from 5mVrms to 2Vrms, and from 50  $\mu$ Arms (100  $\mu$ Arms on the HP 4285A) to 20mArms. The constant test signal level feature guarantees that the applied test signal level will remain constant for demanding tests. Option 001 HP 4284A will allow you to vary the test signal level from 5mVrms to 20Vrms and from 50 $\mu$ Arms to 200mArms, offering a convenient method of testing components over a wide range of working conditions. The dc bias is selectable from  $\pm$ 1mV to  $\pm$ 40V with an accuracy of 0.1% for applications which require accurate bias control, such as measuring the C-V characteristics of semiconductors.

### High Accuracy, Resolution, and Test Throughput

The HP 4284A's wide impedance measurement range covers from 1 $\Omega$  to 100M $\Omega$  full scale with 0.01m $\Omega$  minimum resolution and with an unmatched basic accuracy of 0.05% to 1MHz. The HP 4285A covers a wide impedance range up to 10 M $\Omega$  with a basic accuracy of 0.1%, permitting more accurate component tests at RF frequencies than previously available LCR meters. Six full digits of resolution for all measurement parameters allow you to determine even the smallest differences in materials or component performance. A dissipation factor measurement resolution of 0.000001 is very useful when developing low loss capacitors and inductors used in high performance

electronic equipment. The measurement time needed to obtain the optimum accuracy is only 190ms/meas. (1kHz). A selectable integration time permits high-throughput testing with a measurement time of only 40ms/meas (1kHz) for a slight tradeoff in accuracy.

### High Current Biasing for Power Inductor Evaluation

Combining the HP 4284A precision LCR meter, HP 42841A current source, and HP 42842A/B current fixture gives you a high-performance power inductor and transformer test system, which enables the testing of inductors up to 1MHz and at high dc current levels, up to 20A (40A with two HP 42841A and the HP 42842B) demanded for components used in advanced switching power supplies. To evaluate the inductors at higher frequencies, the HP 4285A precision LCR meter, HP 42841A current source, and HP 42842C current fixture make measurements up to 30MHz and 10A.

### High Q Measurements of RF Components

The HP 4285A precision LCR meter together with the HP 42851A precision Q adapter permits fast and accurate Q factor measurements up to 999.999 with the resonant measurement method. The automatic tuning, 5-digit display, and variable test level allow you to measure Q factors of RF components and materials in a fraction of the time previously required.

### Flexibility and Ease of System Integration

The HP 4284As built-in comparator, advanced compensation, and optional handler and scanner interfaces permit easy integration with automatic component handling equipment. The 10-bin comparator allows for error free Go/No-Go testing by comparing a component's measured value with user selected test limits. The scanner interface provides control and compensation for up to 128 (HP 4284A) or 90 (HP 4285A) multiplexed measurement channels. The list sweep feature permits up to ten frequencies, test signal levels, or bias level points to be automatically measured. The high-speed HP-IB interface and SCPI programming language are excellent for data logging and system applications.



### Simple Operation for Error-Free Measurement Setup

The large, easy-to-read LCD screen displays the instrument settings and the measurement results. The new softkey and cursor operation provides user-friendly front panel operation. The memory card allows storing and retrieving up to ten entire instrument setups, including bin-limit information. It improves operator efficiency and minimizes setup errors.

### Specifications

(Refer to data sheet for complete specifications)

**Parameters measured:**  $|Z|$ - $\theta$ ,  $|Y|$ - $\theta$ , R-X, G-B  
C-D, Q, ESR, G, Rp  
L-D, Q, ESR, G, Rp  
Deviation and % deviation

**Measurement circuit modes:** series and parallel

**Ranging:** auto and manual

**Trigger:** internal, external and manual

**Delay time:** 0 to 60.000s in 1ms steps

**Measurement terminals:** four-terminal pair

**Test cable length:**

HP 4284A: Standard: 0 and 1 m  
with Option 006: 0, 1, 2 and 4 m

HP 4285A: 0, 1 and 2m

**Integration time:** short, medium and long

**Averaging:** 1 to 256, programmable

**Test Signal:**

HP 4284A: 20Hz to 1MHz  $\pm$  0.01%, 8610 selectable frequencies

HP 4285A: 75kHz to 30MHz  $\pm$  0.01%, 100Hz steps

**Test signal modes:**

**Normal:** Programs selected voltage or current at the measurement terminals open or shorted, respectively, and not at the device under test.

**Constant:** Maintains selected voltage or current at the device under test independent of changes in the device's impedance.

**Test signal level**

#### HP 4284A Standard

		Range	Accuracy
Normal	V	5mVrms to 2Vrms	$\pm(10\% + 1mVrms)$
	I	50 $\mu$ Arms to 20mArms	$\pm(10\% + 10\mu$ Arms)
Constant	V	10mVrms to 1Vrms	$\pm(6\% + 1mVrms)$
	I	100 $\mu$ Arms to 10mArms	$\pm(6\% + 10\mu$ Arms)

#### HP 4284A with Option 001:

		Range	Accuracy
Normal	V	5mVrms to 20Vrms	$\pm(10\% + 1mVrms)$
	I	50 $\mu$ Arms to 200mArms	$\pm(10\% + 10\mu$ Arms)
Constant	V	10mVrms to 10Vrms	$\pm(10\% + 1mVrms)$
	I	100 $\mu$ Arms to 100mArms	$\pm(10\% + 10\mu$ Arms)

#### HP 4285A

		Range	Accuracy
Normal	V	5mVrms to 2Vrms	$\pm(8\% + 0.4fm\% + 1mVrms)$
	I	200 $\mu$ Arms to 20mArms	$\pm(8\% + 1fm\% + 40\mu$ Arms)
Constant	V	10mVrms to 1Vrms	$\pm(6\% + 0.2fm\% + 1mVrms)$
	I	100 $\mu$ Arms to 20mArms	$\pm(6\% + 0.2fm\% + 40\mu$ Arms)

fm: test frequency (MHz)

#### dc bias

HP 4284A standard : 0V, 1.5V and 2V

HP 4284A/4285A Option 001: 0V to  $\pm$ 40V

Range	Resolution	Accuracy
$\pm(0.000$ to $4.000)V$	1mV	$\pm(0.1\% + 1mV)$
$\pm(4.002$ to $8.000)V$	2mV	$\pm(0.1\% + 2mV)$
$\pm(8.005$ to $20.000)V$	5mV	$\pm(0.1\% + 5mV)$
$\pm(20.01$ to $40.00)V$	10mV	$\pm(0.1\% + 10mV)$

### Measurement Range

Parameter	Range
$ Z $ , R, X	0.01m $\Omega$ to 99.9999M $\Omega$
$ Y $ , G, B	0.01nS to 99.9999S
C	HP 4284A: 0.01fF to 9.9999F HP 4285A: 0.01fF to 999.999 $\mu$ F
L	HP 4284A: 0.01nH to 99.9999kH HP 4285A: 0.001nH to 99.9999H
D	0.000001 to 9.99999
Q	0.01 to 99999.9
$\theta$	-180.000 $^\circ$ to 180.000 $^\circ$
$\Delta$ %	-999.999% to 999.999%

### Display

LCD dot-matrix display: displays measured values, control settings, comparator limits and decisions, list sweep tables, self-test messages and annunciations.

### Correction function

**Zero OPEN/SHORT:** Eliminates measurement errors due to the test fixture's stray parasitic impedance.

**Load:** Improves measurement accuracy by using a calibrated device as reference.

### List sweep function

A maximum of ten frequencies or test signal levels can be programmed. Single or sequential testing can be performed. When Option 001 is installed, dc voltage bias testing can also be performed.

### Comparator

Ten-bin sorting for the primary measurement parameter. IN/OUT for the secondary measurement parameter.

**Bin count:** 0 to 999999

**List sweep comparator:** HIGH/IN/LOW decision output for each measurement point in the list sweep table.

### Other Functions

**STORE/LOAD:** Ten instrument setups can be stored/ loaded from the internal non-volatile memory. Ten additional setups can also be stored/loaded from a memory card.

**HP-IB:** All instrument control settings, measured values, comparator limits, list sweep table, and self test results. The memory buffer can store a maximum of 128 measurement results and output the data over HP-IB. ASCII and 64-bit binary data formats.

### Options

#### Opt 001:

HP 4284A: Increases the ac test signal to 20 Vrms/ 200mArms. Variable  $\pm$ 40 Vdc bias.

HP 4285A: Variable  $\pm$ 40 Vdc bias.

#### Opt 002:

HP 4284A: Allows the HP 4284A to control the HP 42841A bias current source.

HP 4285A: Allows the HP 4285A to control the HP 42841A bias current source and the HP 42851A precision Q adapter.

**Opt 006 (HP 4284A only):** Increases test cable length capability. Adds 2 and 4 m operation.

**Opt 109:** Delete HP-IB interface

**Opt 201:** Handler interface

**Opt 202:** Handler interface

**Opt 301:** Scanner interface. Provides control interface for operation with a scanner. OPEN/SHORT/LOAD correction data for each scanner channel is stored in non-volatile memory.

HP 4284A: 128 channels at three frequencies.

HP 4285A: 90 channels at seven frequencies.

# COMPONENT MEASUREMENT

## Precision LCR Meters (cont'd)

HP 4284A, 4285A

### General

**Power requirements:** 100/120/220 V ± 10%, 240 V +5%/-10%, 47 to 66Hz

**Power consumption:** 200VA max.

Operating temperature and humidity: 0 to 55°C, ≤95% RH at 40°C

**Size:** 177H × 426W × 498mmD

**Weight:** Approximately 16kg

### HP 4284A Measurement Accuracy

The following measurement accuracy is specified when all of the following conditions are satisfied.

1. Warm up time: ≥30 minutes
2. Ambient temperature: 23 ± 5°C
3. Test signal voltage: 0.3 Vrms to 1 Vrms
4. Test cable length: 0 m
5. OPEN and SHORT corrections have been performed
6.  $D \leq 0.1$  for C, L, X and B measurements  
 $Q \leq 0.1$  for R and G measurements

Accuracies are relative to calibrated standards. Absolute accuracies are given as: (HP 4284A's relative accuracy + calibration uncertainty of standards).

|Z|, C, L and D accuracies are shown in Figure 1.

The accuracies are represented as;

|Z|, C and L: ± (% of reading)

D: ± (D value)

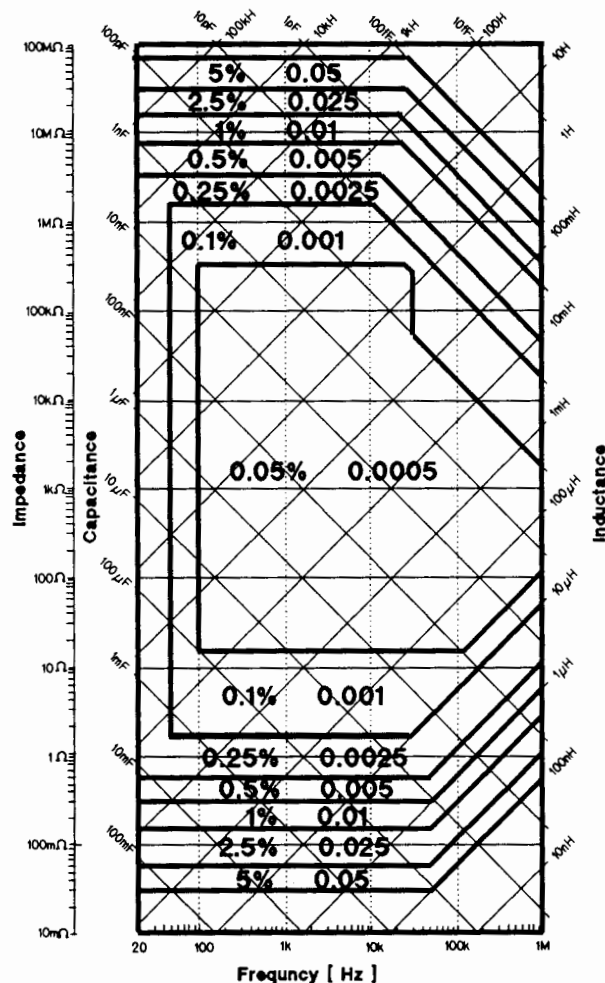

Figure 1. HP 4284A Measurement Accuracy

### HP 4285A Measurement Accuracy

The following measurement accuracy is specified when all of the following conditions are satisfied.

1. Warm up time: ≥30 minutes
2. Ambient temperature: 23 ± 5°C
3. Test signal voltage: 0.2 Vrms to 1 Vrms
4. Test cable length: 0 m
5. OPEN and SHORT corrections have been performed
6.  $D \leq 0.1$  for C, L, X and B measurements  
 $Q \leq 0.1$  for R and G measurements

|Z|, C, L and D accuracies are shown in Figure 2.

The accuracies are represented as;

|Z|, C and L: ± (% of reading)

D: ± (D value)

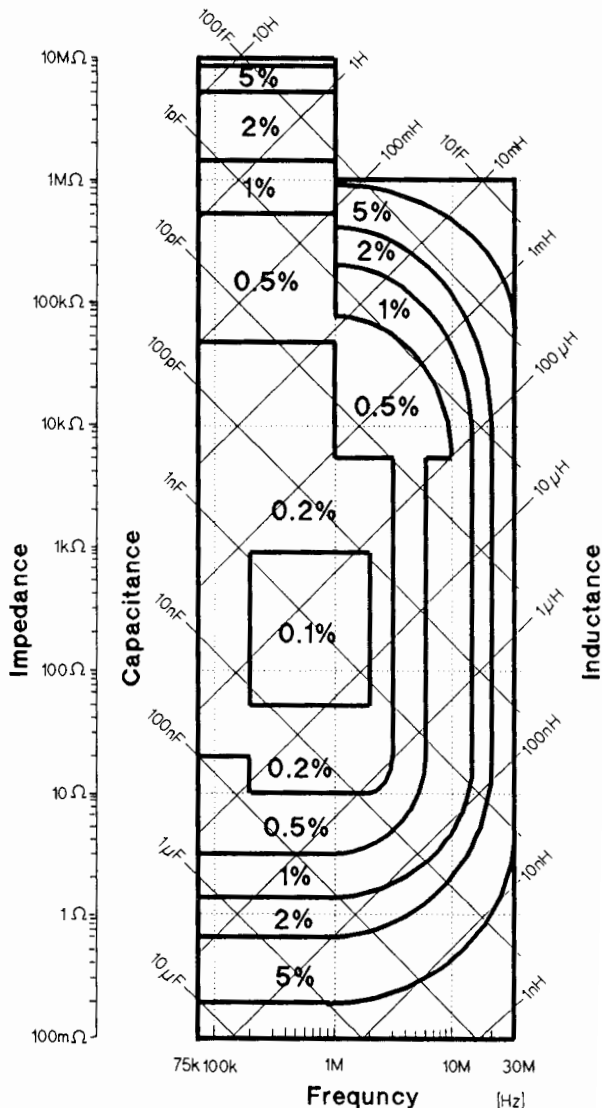

Figure 2. HP 4285A Measurement Accuracy

**Supplemental Characteristics**

**Measurement time:** Typical measurement time from the trigger command to the EOM (End of Measurement) output at the handler interface connector.

**HP 4284A**

	20Hz	100Hz	1kHz	10kHz to 1MHz
SHORT	1,100ms	270ms	40ms	30ms
MEDIUM	1,320ms	400ms	190ms	180ms
LONG	1,320ms	1,040ms	830ms	820ms

**HP 4285A**

	75kHz to 30MHz
SHORT	30ms
MEDIUM	65ms
LONG	200ms

**Option 001 dc Bias current output:** 100mA max

**Accessories**

**HP 42841A Bias Current Source**

**Bias current output:** (23 ± 5°C)

Range	Resolution	Accuracy
0.00A to 1.00A	0.01A	±(1% of setting + 5mA)
1.1A to 5.0A	0.1A	±(2% of setting)
5.1A to 20.0A	0.1A	±(3% of setting)

**Output Voltage:**

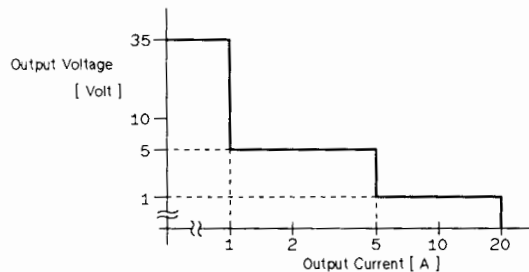

**Basic impedance accuracy:** 1% when used with the HP 4284A/4285A.

**Interface:** Custom directly controllable by the HP 4284A/4285A with Option 002.

**HP 42842A/B bias current test fixture**

Used with the HP 4284A and HP 42841A for high DC bias current measurements.

HP 42842A: 20A max

HP 42842B: 40A max

**HP 42842C bias current test fixture**

Used with the HP 4285A and HP 42841A for high DC bias current measurements. 10A max.

**HP 42843A bias current cable**

Used with the HP 4284A, HP 42841A (2 units) and HP 42842B for 40A maximum applications.

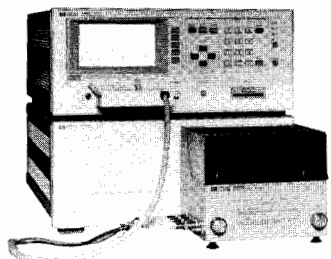

HP 4284A with HP 42841A and HP 42842A

**HP 42851A Precision Q Adapter**

Used with the HP 4285A for resonant Q measurements.

**Parameters measured:** Q-L, Q-C

**Q measurement range:** 5.00 to 999.99

**Basic Q accuracy:** 5%

**Measurement time:** 75ms to 1.5s

**Interface:** Custom, directly controllable by the HP 4285A with Option 002.

**Opt 001:** SMD Test Fixture

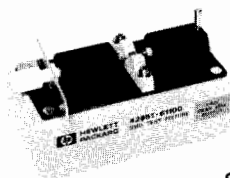

SMD Test Fixture

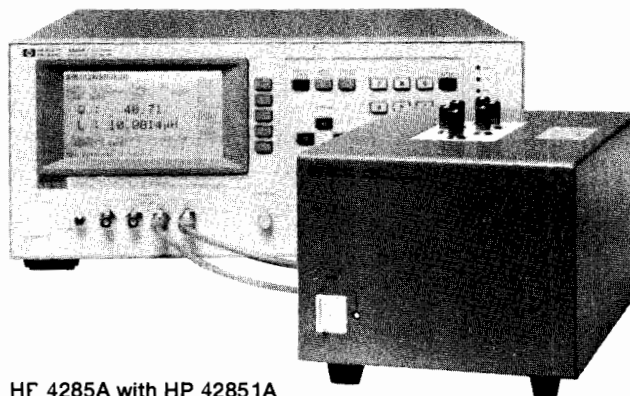

HP 4285A with HP 42851A

**Ordering Information**

	Price
HP 4284A Precision LCR Meter	\$10,200
HP 4285A Precision LCR Meter	\$12,900
Opt 001 Power Amplifier/DC Bias (HP 4284A) dc Bias (HP 4285A)	+\$1,200 +\$920
Opt 002 Bias Current Interface (HP 4284A) Accessory Control Interface (HP 4285A)	+\$280 +\$280
Opt 006 2m/4m Cable Length Operation (HP 4284A only)	+\$180
Opt 009 Delete Operation Manual	-\$80
Opt 109 Delete HP-IB Interface	-\$240
Opt 201 Handler Interface	+\$280
Opt 202 Handler Interface	+\$310
Opt 301 Scanner Interface	+\$600
Opt W30 Extended repair service. See page 723.	
(HP 4284A)	+\$190
(HP 4285A)	+\$215
HP 42841A Bias Current Source	\$6,800
HP 42842A Bias Current Test Fixture (20A max)	\$1,600
HP 42842B Bias Current Test Fixture (40A max)	\$2,000
HP 42842C Bias Current Test Fixture (10A max)	\$2,500
Opt 001 SMD Test Fixture (HP 42842C only)	+\$430
HP 42843A Bias Current Cable	\$1,000
HP 42851A Precision Q Adapter	\$4,850
Opt 001 SMD Test Fixture	+\$430

Refer to page 301 for accessories.

# COMPONENT MEASUREMENT

## Multi-Frequency LCR Meters

HP 4274A, 4275A

- Test frequencies – HP 4274A: 100 Hz to 100 kHz  
HP 4275A: 10 kHz to 10 MHz
- Test signal level – HP 4274A: 1 mV to 5 Vrms  
HP 4275A: 1 mV to 1 Vrms
- 0.1% basic accuracy
- High resolution – 5½ digit; D=0.00001
- Measure L/C – D/Q/ESR/G;  $|Z| - \theta$ ,  
R-X/B/L/C;  $\Delta$ LCRZ,  $\Delta\%$

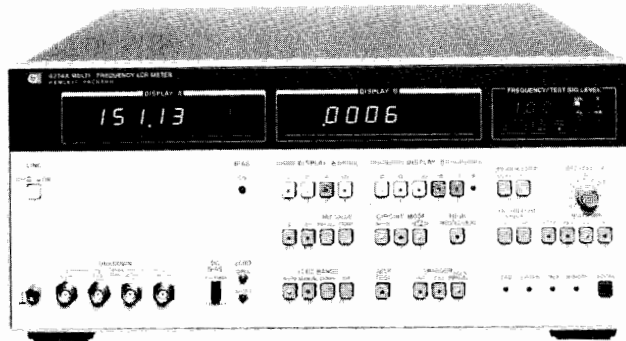

HP 4274A

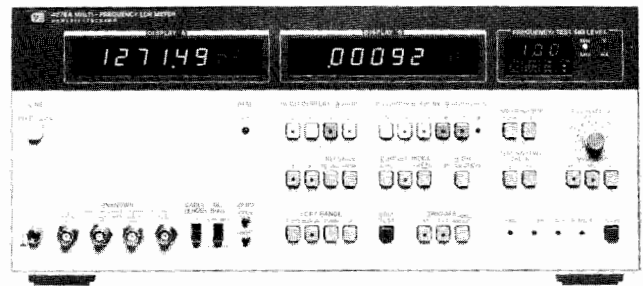

HP 4275A



### Description

The HP 4274A and HP 4275A Multi-frequency LCR Meters, microprocessor-based impedance measuring instrumentation. Both instruments offer LCR components, complex components, electronic circuits "tested under actual working conditions", and semiconductor materials. A measurement under conditions similar to the intended use contributes to the improvements in quality and reliability of electronic components, devices and circuits.

### Reliable Measurements with 5½ Digit Resolution

The HP 4274A and HP 4275A measure only the value of the component and/or device under test, with 5½ resolution and 0.1% basic accuracy by reducing the possibility of errors due to self or mutual inductance, stray capacitance and/or residual inductance in the test leads or test fixture used. This measurement is obtained by a state-of-the-art four terminal pair configuration and a built-in automatic ZERO-offset capability to compensate for these errors.

The fast measurement speed, high resolution, and high accuracy can make major contributions for the component manufacturer and user who is concerned about reducing his costs, improving quality, and throughput efficiency. In these areas, the HP 4274A and the HP 4275A are ideal for D-measurements of film capacitors or insulation material (with the high resolution of 0.00001), the C-G measurements of semiconductors (with maximum resolutions of 0.01 fF, 0.01 nS, respectively), and for the low impedance measurement of aluminum electrolytic capacitors (with a maximum resolution of 0.001 mΩ).

### Multi-Frequency Capability

To insure the high reliability in circuits and devices, it is most important that they be tested and evaluated at test signals similar to those of actual operating conditions.

The HP 4274A covers the wide frequency range of 100 Hz to 100 kHz in 11 spot frequencies and the HP 4275A has 10 spot frequencies from 10 kHz to 10 MHz, in 1-2-4 step sequence with 1-3-5 as an option. This feature produces the frequency characteristics of components or devices. In addition, two optional special frequencies (for example, 455 kHz and 10.7 MHz) are available within the frequency

range of each instrument. This wide frequency range selection offers evaluation of circuit design with a continuously variable test signal over the range of 1 mV to 5 Vrms (to 1 Vrms for the HP 4275A), and with internal dc bias optionally available with 1 mV maximum resolution. The test voltage or current values can be monitored on the 3-digit display for accurately setting the actual conditions under which the device-under-test will operate.

### Multi-Parameter Measurements

The HP 4274A and HP 4275A measure equivalent series resistance (ESR), impedance ( $|Z|$ ), phase angle ( $\theta$ ), reactance (X), susceptance (B), and conductance (G), in addition to the conventional L, C, R, D and Q parameters in certain combinations with a dual 5½ digit display, and an HP-IB standard for systems integration.

This wide selection of 11 parameters provides for more accurate evaluation of electronic materials or components with high measurement speed for most needed combined parameters; for example, the C-G measurement of semiconductors, an R-X measurement in circuit design, or the C-ESR or  $|Z| - \theta$  measurement of tantalum capacitors.

In addition, a deviation measurement capability ( $\Delta, \Delta\%$ ) for the L, C, R, and  $|Z|$  functions displays the difference between the actual value and a stored reference, either as a difference value or in percent. Deviation applications include, for example, a temperature dependence measurement of devices in environmental tests.

### Automatic Semiconductor and Component Measurements with HP-IB

Integrating the HP 4274A and the HP 4275A into an HP-IB controlled system is an excellent method for improving efficiency and cost savings both in the laboratory and on the production line. These automatic measurement systems are assembled by connecting the HP-IB cables between the instruments to be utilized for a specific task.

For example, the evaluation of semiconductors based on the frequency dependence of its C-V characteristics that requires a wide range and fast measurement speeds is easily accomplished with these instruments.



**Specifications**

Refer to the HP 4274A & HP 4275A data sheet for details.

**Parameters Measured**

L: inductance C: capacitance	Q: =1/D ESR: equivalent series resistance	θ: phase angle Δ: deviation for L, C, R, Z, Δ%: % of deviation
R: resistance Z: impedance D: dissipation factor	G: conductance X: reactance B: susceptance	

**Measurement Range**

MODEL	HP 4274A	HP 4275A
L	100.00 nH - 1000.0 H	100.00 nH - 10.00 H
C	1.0000 pF - 1.00 F	1.0000 pF - 100.00 μF
R,  Z , ESR, & X	100.00 mΩ - 10.000 MΩ	1.0000 Ω - 10.000 MΩ
D	0.00001 - 9.9999	0.00001 - 9.9999
Q (1/D)	0.01 - 9900	0.01 - 9900
G & B	1.0000 μS - 100.00 S	1.0000 μS - 10.00 S
θ	0 - ±180°	0 - ±180°

**Measurement Accuracy**

FREQUENCY RANGE	C-D/Q	L-D/Q
	D-range: 0.00001-9.9999 Q-range: 0.01-9900 (=1/D) (C & D accuracies apply only when C: full scale and D: < 0.1)	D-range: 0.00001-9.9999 Q-range: 0.01-9900 (=1/D) (L & D accuracies apply only when L: full scale and D: < 0.1)

**HP 4274A**

100 Hz	C: 1000 pF-1000 mF, 0.1% + 3 D: 0.33% + 0.0008 + 1	L: 100 μH-10 kH, 0.1% + 3 D: 0.33% + 0.0013 + 1
200 Hz	C: 1000 pF-1000 mF, 0.1% + 2 D: 0.32% + 0.0007 + 1	L: 100 μH-10 kH, 0.1% + 3 D: 0.32% + 0.0012 + 1
400 Hz	C: 100 pF-100 mF, 0.14% + 1 D: 0.34% + 0.0013 + 1	L: 100 μH-10 kH, 0.1% + 3 D: 0.31% + 0.0011 + 1
1 kHz	C: 100 pF-100 mF, 0.1% + 3 D: 0.33% + 0.0008 + 1	L: 10 μH-1000 H, 0.1% + 3 D: 0.33% + 0.0013 + 1
2 kHz	C: 100 pF-100 mF, 0.1% + 2 D: 0.32% + 0.0007 + 1	L: 10 μH-1000 H, 0.1% + 3 D: 0.32% + 0.0012 + 1
4 kHz	C: 10 pF-10 mF, 0.14% + 1 D: 0.34% + 0.0013 + 1	L: 10 μH-1000 H, 0.1% + 3 D: 0.31% + 0.0011 + 1
10 kHz	C: 10 pF-10 mF, 0.1% + 3 D: 0.33% + 0.0008 + 1	L: 1 μH-100 H, 0.1% + 3 D: 0.33% + 0.0013 + 1
20 kHz	C: 10 pF-10 mF, 0.1% + 2 D: 0.32% + 0.0007 + 1	L: 1 μH-100 H, 0.1% + 3 D: 0.32% + 0.0012 + 1
40 kHz	C: 1 pF-1000 μF, 0.14% + 1 D: 0.34% + 0.0013 + 1	L: 1 μH-100 H, 0.1% + 3 D: 0.31% + 0.0011 + 1
100 kHz	C: 1 pF-1000 μF, 0.1% + 3 D: 0.33% + 0.0008 + 1	L: 100 nH-10 H, 0.1% + 3 D: 0.33% + 0.0013 + 1

**HP 4275A**

10 kHz	C: 10 pF-100 μF, 0.1% + 3 D: 0.33% + 0.008 + 1	L: 10 μH-100H, 0.1% + 3 D: 0.33% + 0.0013 + 1
20 kHz	C: 10 pF-100 μF, 0.1% + 2 D: 0.32% + 0.0007 + 1	L: 10 μH-100 H, 0.1% + 3 D: 0.32% + 0.0012 + 1
40 kHz	C: 1 pF-10 μF, 0.14% + 1 D: 0.34% + 0.0009 + 1	L: 10 μH - 100 H, 0.1% + 3 D: 0.31% + 0.0011 + 1
100 kHz	C: 1 pF-10 μF, 0.1% + 3 D: 0.33% + 0.0008 + 1	L: 1 μH - 10 H, 0.1% + 3 D: 0.33% + 0.0013 + 1
200 kHz	C: 10 pF-10 μF, 0.1% + 2 D: 0.32% + 0.0007 + 1	L: 1 μH - 1000 mH, 0.2% + 3 D: 0.53% + 0.0023 + 1
400 kHz	C: 1 pF-1000 nF, 0.14% + 1 D: 0.34% + 0.0009 + 1	L: 1 μH - 1000 mH, 0.2% + 3 D: 0.51% + 0.0021 + 1
1 MHz	C: 1 pF-1000 nF, 0.1% + 3 D: 0.33% + 0.0008 + 1	L: 100 nH - 100 mH, 0.2% + 3 D: 0.55% + 0.0025 + 1
2 MHz	C: 10 pF-100 nF, 0.3% + 3 D: 0.55% + 0.0025 + 1	L: 1 μH - 10 mH, 0.5% + 5 D: 1.0% + 0.0033 + 1
4 MHz	C: 1 pF-10 nF, 1% + 20 + 0.002 pF D: 3.3% + 0.01 + 1	L: 1 μH - 10 mH, 1% + 5 D: 2.0% + 0.0063 + 1
10 MHz	C: 1 pF-10 nF, 2% + 20 + 0.002 pF D: 4% + 0.011 + 1	L: 100 nH - 1 mH, 2% + 7 D: 3.1% + 0.002 + 1

**Range:** full scale range, accuracy: % of reading + counts (D accuracy: % of reading + absolute D value + count).  
(Conditions: Warm-up time ≥ 30 minutes, environment temperature: 23°C ± 5°C).  
Refer to technical data sheet for accuracy details.

**Measurement Frequencies**

HP 4274A: 100 Hz-100 kHz, 11 spots (100 Hz, 120 Hz, 200 Hz, 400 Hz, 1 kHz, 2 kHz, 4 kHz, 10 kHz, 20 kHz, 40 kHz, 100 kHz; ±0.01%)

HP 4275A: 10 kHz-10 MHz, 10 spots (10 kHz, 20 kHz, 40 kHz, 100 kHz, 200 kHz, 400 kHz, 1 MHz, 2 MHz, 4 MHz, 10 MHz; ±0.01%)

**Test Signal Level:**

HP 4274A: 4-ranges (1 mVrms-5 Vrms) continuously variable

HP 4275A: 3-ranges (1 mVrms-1 Vrms) continuously variable

**Test Signal Level Monitor:** standard.

**Displays:** dual 5 1/2-digit and single 3-digit; maximum display 199999 (full scale and overrange in high resolution mode), and 4 1/2-digit: maximum display 19999 in normal mode. (Number of digits depends on measurement frequency, test level, and range).

**Circuit modes:** series equivalent circuit and parallel equivalent circuit. Automatic selection available in AUTO mode.

**Deviation measurement:** difference between recallable stored reference and displayed is deviation value (count or percent).

**Ranging:** AUTO or MANUAL (UP/DOWN).

**Trigger:** internal, external or manual.

**Measurement terminals:** four-terminal pair with guard.

**Auto zero adjustment:** automatic normalization of the readout offset due to residuals of the test fixture by pushbutton operation.

**Normalization range:** C < 20 pF, L < 2000 nH, R < 0.5Ω, G < 5μS.

**Self test:** automatic operational verification check indicates pass or fail condition.

**Reference Data**

**Measurement time:** (typical) 140-180 ms (>1 kHz); 140-210 ms ≤ 1 kHz (measurement time depends on range, sample value and offset adjustment value).

**Z - θ measurement time:** 170-210 ms >1 kHz; 170-240 ms ≤ 1 kHz.

**High resolution mode:** approximately 8 times the normal measurement time.

**Auto ranging time:** 100 ms - 300 ms per range change.

**General Information**

**Operating Temperature and Humidity:** 0°C - 55°C, ≤95% RH at 40°C

**Power:** 100, 120, 220V ±10%, 240V + 5% - 10%, 48 - 66Hz, 135VA max. (HP 4274A); 165VA max. (HP 4275A)

**Size:** 177H x 425W x 574Dmm (7" x 16.75" x 22.6")

**Weight:** 18kg (39.6lbs)

**Accessory Furnished**

HP 16047A: Direct coupled test fixture.

**Special Options**

One or two arbitrary test frequencies for each instrument are available. For more details, please contact nearest HP sales office.

**Selectable Frequency Range**

**HP 4274A:** 100 Hz to 100 kHz to ±0.1%. If two frequencies are added, at least one frequency must satisfy the following equation: f = 1200/N kHz where N is an integer from 12 to 12000.

**HP 4275A:** 10 kHz to 10.7 MHz ±0.1%.

**Ordering Information**

**HP 4274A Multi-Frequency LCR Meter** **Price**  
\$10,700

Opt W30: Extended repair service. See page 723. +\$260

**HP 4275A Multi Frequency LCR Meter** \$12,850

Opt W30: Extended repair service. See page 723. +\$260

Opt 001: 0 to ±35 internal dc bias, max resolution;

1 mV steps +\$965

Opt 002: 0 to ±99.9 V internal dc bias, resolution:

100 mV steps. +\$915

Opt 004: Frequency steps in 1-3-5 sequence \$0

**Accessory Available**

**HP 16023B:** dc Bias Controller, for control of dc bias \$350

Opt 001 or 002 Internal Bias Supply.

☎ For same-day shipment, call HP DIRECT at 800-538-8787.

# COMPONENT MEASUREMENT

## 1 kHz / 1 MHz Capacitance Meter

HP 4278A

- Measurement Speed: 6.5ms/10ms/21ms
- Measurement Parameters: C-D•Q•ESR•G
- C-D Measurement Accuracy:
  - 0.07%, 0.0005(1kHz, 21ms)
  - 0.05%, 0.0002(1MHz, 21ms)
- High Resolution: 6 digit, D:0.00001
- Intelligent Built-in Comparator: 10-bin Sorting

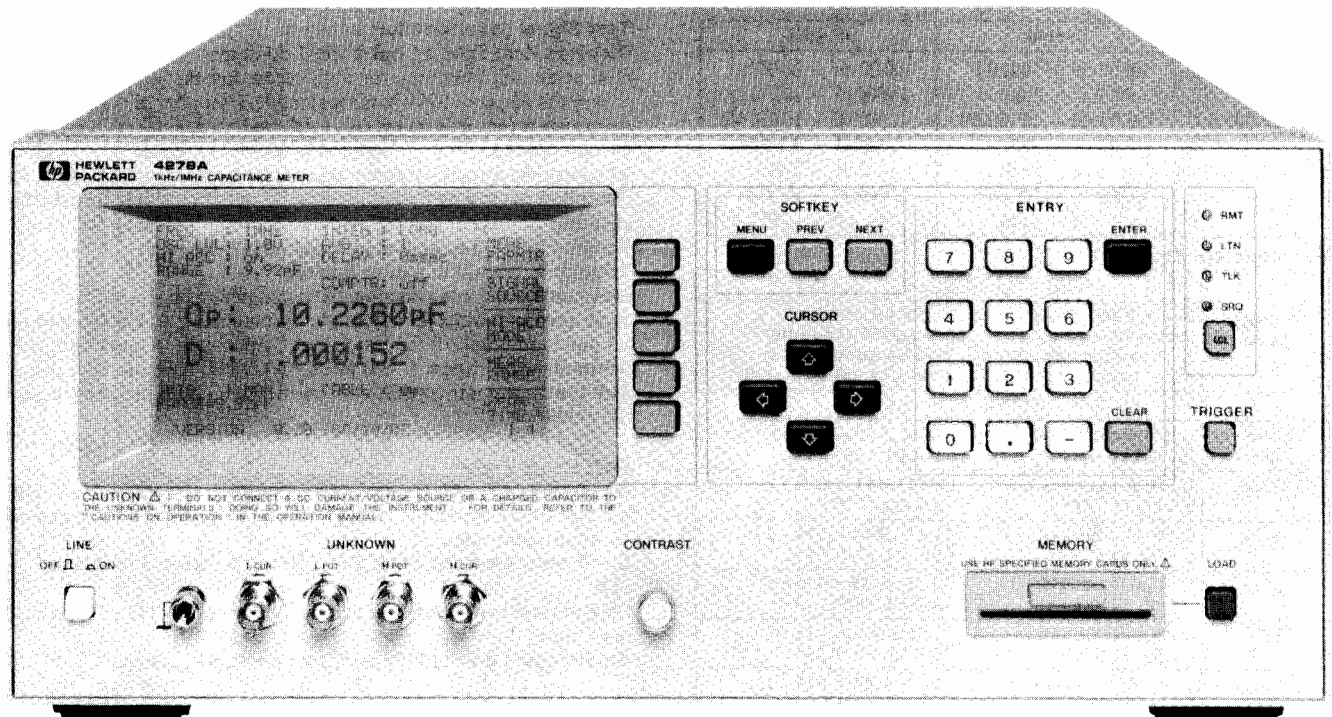

HP 4278A

### Description

The HP 4278A 1kHz/1MHz Capacitance Meter is a high speed, highly reliable, precision test instrument aimed at incoming/outgoing capacitor inspection applications on the production line and in quality control. The HP 4278A will improve test efficiency by performing comparative measurements of low to medium value capacitors (up to 200  $\mu$ F—a range that covers most ceramic and film capacitors) several times faster than previously available capacitance meters.

The HP 4278A's standard measurement frequencies and oscillator output levels are 1kHz/1MHz and from 0.1V to 1V in 0.1V steps, respectively. The HP 4278A's ability to make precision capacitance measurements and to measure low dissipation values will give you an edge in improving the quality of your devices.

The built-in comparator function of the HP 4278A gives you the ability to sort parts into ten bins. A high speed HP-IB interface and an optional handler interface are available for combining the HP 4278A with an automatic handler and an external computer to build a total solution for automatic testing and data acquisition and analysis.

### High Speed Measurements

One of the HP 4278A's main features is its selection of high measurement speeds: 6.5ms (153 measurements/sec), 10ms (100 measurements/sec), or 21ms (47 measurements/sec), with a fast settling time. Additionally, the HP 4278A's built-in comparator and high speed HP-IB interface make it possible to construct a measurement system using an automatic handler and an external computer to minimize production test time, and, therefore, cost.

### High Accuracy and Resolution

Dissipation factor (D), the parameter measured to determine the quality of capacitors, can be measured with an accuracy of 0.0002 (1MHz) and 0.0005 (1kHz) with a resolution of 0.00001 without degrading measurement speed. The HP 4278A has high capacitance measurement accuracy, 0.05% (1MHz) and 0.07% (1kHz) with 6 full digits of resolution in all measurement ranges, 1pF to 2048 pF (1MHz), and 100pF to 100  $\mu$ F (1kHz).

The pushbutton zero adjustment function is used to compensate for stray impedance and admittance of the handler and test fixture. The auto calibration function, when used with a capacitance standard, can be used to calibrate the system up to the point of device connection.

### Intelligent Built-in Comparator

The intelligent built-in comparator gives the HP 4278A the capability to use nine sets of high and low capacitance values and one set of dissipation limits to sort capacitors into nine bins, according to their capacitance values and whether or not they meet the dissipation limits. Capacitors which are not within the capacitance limits or do not meet the dissipation limits go into the tenth or no-go bin.

All comparator settings can be controlled and monitored using an external computer, and the results of the comparisons can be transferred to a handler interface (optional). All control settings and comparator parameters can be saved on the removable EEPROM memory module (memory card) to facilitate instrument setup and to minimize the chance of an instrument setup error.

**Specifications**

(refer to data sheet for complete specifications)

**Measurement Parameters:** C-D-Q-ESR-G

**Display:** Dot-matrix LCD. Displays measurement values with 4, 5, or 6 digit resolution, control settings, comparator limits, the comparator's decision, self test messages and annunciations.

**Measurement Circuit Modes:** Parallel and Series

**Test Signals:**

**Frequency:** 1kHz and 1 MHz, ±0.02%

**Signal Level:** 0.1 to 1 Vrms, ±10% (C≤20μF), in 0.1Vrms steps

**Measurement Time Modes:** SHORT, MEDIUM, and LONG

**Measurement Times:**

Mode	SHORT	MEDIUM	LONG
Time*	6.5ms	10ms	21ms

\* Measurement time includes Setting, Integration (analog measurements), Calculation, and Comparison times.

No additional measurement time is required for measurements performed in an overload (shorted capacitor) condition.

**Measurement Range**

Measurement Parameter	1 KHz	1 MHz Normal Mode
		1 MHz High Accuracy
C	0.001 pF to 200.000 μF	0.00001 pF to 1280.00 pF 0.00001 pF to 2663.00 pF
DF	0.00001 to 9.99999	0.00001 to 9.99999 .000001 to .999999
Q	0.1 to 99999.9	0.1 to 99999.9 20 to 99999.9
G	0.00001 μS to 9.99999S	0.00001 μS to 9.99999 mS 0.00001 μS to 9.99999 mS
ESR	0.00001Ω to 9.99999 MΩ	0.001Ω to 999.999 KΩ 0.001Ω to 999.999 KΩ

- 1 kHz Normal Mode: 7 decade ranges 100pF to 100μF full scale. 100% overranging on all ranges, (max. 200000 counts) when D ≤ 0.5.
- 1 MHz Normal Mode: 11 binary ranges, 1pF to 1024pF full scale. 25% overranging on all ranges, when D ≤ 1.
- 1 MHz High Accuracy Mode: Measurement range is ±30% of the user defined nominal value, maximum 2048pF. When D ≤ 0.05.

**Measurement Accuracy**

It is specified at the UNKNOWN terminals and at the end of standard 1 or 2 meter test leads under the following conditions. Refer to data sheet for details.

1. Warm Up Time: ≥ 10 minutes.
2. Ambient Temperature is 23 ± 5°C and variance is less than 0.2°C/minute.
3. Test signal level is set to 1 Vrms.
4. Test cable length is 0, 1, or 2 meters (HP 16048A/B/D).
5. Zero OPEN/SHORT compensation has been performed.
6. D ≤ 0.05 for 1MHz High Accuracy Mode.  
D ≤ 0.1 for 1kHz and 1MHz Normal Modes.
7. Accuracies are only valid when the measured value is equal to full scale of each range.
8. Accuracy stated in the tables is given for MEDIUM (upper) and LONG (lower) integration times.
9. Accuracy equations are read as follows:  
C: ± (% of reading + % of full scale)  
D: ± (% of reading + absolute D value)  
(C: ± (% of reading + absolute C value) for Table 3)

**Table 1 1kHz Measurement Accuracy**

C range	C	D
100μF	0.13% + 0.3% 0.07% + 0.025%	0.13% + 0.003 0.065% + 0.0025
100pF - 10μF	0.1% + 0.05% 0.05% + 0.025%	0.1% + 0.001 0.05% + 0.0005

**Table 2 1MHz Normal Mode Measurement Accuracy**

C range	C	D
256 - 1024pF	0.2% + 0.02% 0.1% + 0.02%	0.2% + 0.002 0.1% + 0.0005
4 - 128pF	0.2% + 0.02% 0.05% + 0.02%	
2pF	0.2% + 0.03% 0.05% + 0.03%	0.2% + 0.004 0.1% + 0.001
1pF	0.2% + 0.06% 0.05% + 0.06%	

**Table 3 1MHz High Accuracy Mode Measurement Accuracy**

Nominal C + Open Circuit C	C	D
1024 - 2048pF	0.11% 0.11%	0.0007 0.0004
256 - 1024pF	0.11% 0.07%	0.0007 0.0003
4 - 256pF	0.11% 0.05%	0.0007 0.0002
2 - 4pF	0.1% + 0.0004pF 0.06% + 0.0004pF	0.0008 0.0003
0 - 2pF	0.1% + 0.0004pF 0.08% + 0.0004pF	0.0016 0.0006

**Trigger Modes:** Internal, External, or Manual

**Measurement Terminals:** Four-terminal pair, guarded

**Cable Length Compensation:** 0, 1, or 2m

**Compensation Function**

**Zero OPEN/SHORT:** Compensation range: R ≤ 20Ω, G ≤ 20μS, and unlimited C and L.

**Standard:** Improves measurement accuracy by using a standard capacitor as a reference.

**Offset:** Arithmetic correction of measurement data.

**Comparator:** Ten-bin sorting for capacitance, and go/no-go testing for D, Q, ESR, and G.

**Sorting Modes:** Sequential sorting into un-nested bands with absolute limits, and tolerance sorting into nested bands with absolute or percent limits.

**Self Test:** Checks the HP 4278A's basic operation.

**Memory Card:** External memory for storing and recalling control settings and comparator limits.

**General Specifications**

**Operating Temperature and Humidity:** 0-55°C, 95% RH @ 40°C

**Power:** 100, 120, 220VAC ± 10%, 240VAC +5 -10%, 48-66Hz, 200VA max.

**Dimensions (in mm):** Approximately 426(W) by 177(H) by 498(D)

**Weight:** Approximately 10kg (22lb., standard)

**Reference Data**

**Stability:** LONG integration and constant operating temperature.

C ≤ 0.01%/day

D ≤ 0.0001/day

**Temperature Coefficient:** LONG integration and 23±5°C.

C ≤ 0.01%/°C; 1kHz and 1MHz.

D ≤ 0.0001/°C; 1kHz and 1MHz Normal Mode.

D ≤ 0.00004/°C; 1MHz High Accuracy Mode.

**HP-IB Data Output Speed:** Maximum 100 bytes/ms, typically 3ms for handshake, depending on the system controller.

**Accessories Available**

<b>HP 16270A:</b> Memory Card Set	\$280
<b>HP 16334A:</b> Tweezer-type Test Fixture for Chip Components	\$440
<b>HP 16047A:</b> Direct-coupled Test Fixture	\$270
<b>HP 16047C:</b> Test Fixture	\$310
<b>HP 16048A:</b> Test Leads, BNC (1m)	\$330
<b>HP 16048B:</b> Test Leads, SMC (1m)	\$330
<b>HP 16048D:</b> Test Leads, BNC (2m)	\$430
<b>HP 16380A:</b> Standard Capacitor Set (Refer to page 321.)	\$3010
<b>HP 16380C:</b> Standard Capacitor Set (Refer to page 321.)	\$4585

**Ordering Information**

<b>HP 4278A 1kHz/1MHz Capacitance Meter</b>	\$7840
<b>Opt W30</b> Extended repair service. See page 723	+\$180
<b>Opt 001</b> 1kHz test frequency only	-\$830
<b>Opt 002</b> 1MHz test frequency only	-\$360
<b>Opt 003</b> 1% frequency shift: prevents possible test signal interference when component test contacts are located close to those of other test units	\$0
<b>Opt 009</b> Delete Manual	-\$30
<b>Opt 101</b> HP-IB compatibility	+\$240
<b>Opt 201</b> Handler Interface	+\$280
<b>Opt 202</b> Handler Interface	+\$310
<b>Opt 301</b> Scanner Interface	+\$600

☎ For same-day shipment, call HP DIRECT at 800-538-8787.

# COMPONENT MEASUREMENT

## LCZ Meters

HP 4276A, 4277A

- 3-digit frequency setting:
  - 100 Hz to 20 kHz (801 spots)
  - 10 kHz to 1 MHz (701 spots)
- High speed measurements
- Measure L/C-D/Q/ESR/G,  $|Z| - \theta$ , high speed L/C
- 10-bin component sorting-comparator (OPT. 002)
- 0.1% basic accuracy over impedance range of 100 m $\Omega$  to 10 M $\Omega$  (HP 4276A), 10 $\Omega$  to 1 M $\Omega$  (HP 4277A)

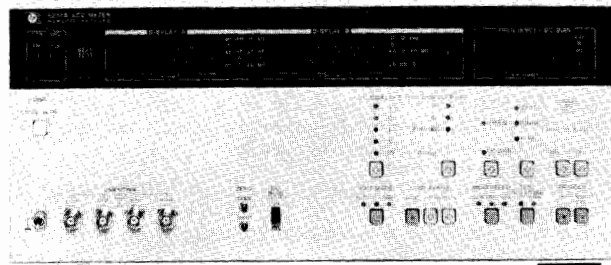

HP 4276A

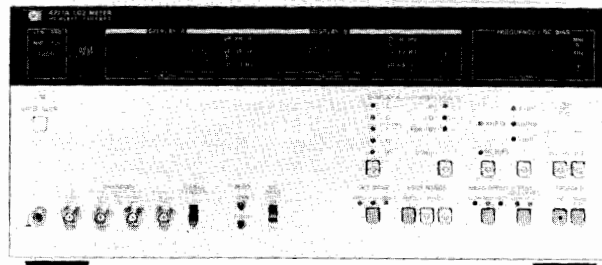

HP 4277A

### Description

HP's 4276A and 4277A LCZ Meters are general purpose impedance measuring instruments designed to measure circuit components such as capacitors and inductors using frequency and dc bias conditions identical to those of the intended application. Both HP 4276A and HP 4277A feature variable test frequency (100 Hz – 20 kHz and 10 kHz – 1 MHz respectively), optional dc bias variable from 0 to  $\pm 40$  V, multiple parameters (L • C • |Z| • D • Q • ESR • G •  $\theta$ ) with fully automatic high speed measurements, and 4½ digit resolution. The HP 4276A has an impedance range of 100 m $\Omega$  to 10 M $\Omega$  and the HP 4277A 10  $\Omega$  to 1 M $\Omega$ .

Both instruments are ideal for production line, quality control, and circuit design applications, and are versatile enough for stand-alone use or systems use under HP-IB control (standard). An optional comparator for 10-bin sorting with measurement time of less than 100 ms make the HP 4276A/4277A a good choice for production line testing of discrete components.

**Specifications** (Refer to data sheet for complete specifications)  
Common to HP 4276A and HP 4277A

**Parameters measured:** C • D • Q • ESR • G • L • D • Q • ESR • G  
high speed L, high speed C  
 $|z| - \theta$  and  $\Delta$  (deviation for any parameter)

**Display:** 4½ digits (max), maximum display 19999

**Measurement circuit modes:** Auto, Parallel, and Series

**Frequency control modes:** SPOT, COARSE (10 freq./decade), and FINE (max. freq. resolution).

**Test Signal Level** (unknown terminal open)

	HIGH	LOW
HP 4276A	1 Vrms $\pm 10\%$ @ 1kHz	50 mV $\pm 20\%$ (CP only) @ 1kHz
HP 4277A	1 Vrms $\pm 10\%$	20 mV $\pm 15\%$

**Test frequencies:**

**HP 4276A** - 100 Hz to 20 kHz  $\pm 0.01\%$  (801 points)

**HP 4277A** - 10 kHz to 1 MHz  $\pm 0.01\%$  (701 points)

**Measurement accuracy and range:** specified at the front panel unknown connectors when all of the following conditions are satisfied:

- (1) warmup time  $\geq 30$  min.
- (2) test signal level is set to HIGH (1 Vrms)
- (3) measurement speed mode: MED or SLOW
- (4) ambient temperature is 23°C  $\pm 5$ °C
- (5) cable length switch is set to 0 m (HP 4277A)
- (6) OPEN and SHORT adjustments have been made
- (7) D  $\leq 0.1$

### C Measurement Basic Accuracy:

**HP 4276A:** 0.1% + 17 counts to 3% + 2 counts

**HP 4277A:** 0.1% + 17 counts to 3% + 4 counts

### DC Bias

**Internal dc bias (opt.):** 0 to  $\pm 40$  V

### Reference Data

**Measurement Speed (Typical):** (Circuit mode: AUTO, test signal level: HIGH, display digit: 3 digits, FAST mode)

Measurements	HP 4276A @ 1kHz	HP 4277A @ 1MHz
C-D • ESR • G	65 ms	75 ms
L-D • ESR • G	75 ms	65 ms
Z- $\theta$	80 ms	75 ms
High Speed C	35 ms	40 ms

### General Specifications

**Operating temperature and humidity:** 0° to 55°C,  $\leq 95\%$  RH at 40°C.

**Power requirements:** 100/120/220 Vac  $\pm 10\%$ , 240 V + 5% – 10%; 48 to 66 Hz.

**Power consumption:** 65 VA max (HP 4276A);

75 VA max (HP 4277A).

**Size:** 188 mm H x 426 mm W x 422 mm D (7½" x 16¾" x 16½").

**Weight:** approx. 8.5 kg (18.7 lb).

### Special Options

**HP 4276A Opt H05:** 1 kHz C-D measurement only (1V/100mV)

**HP 4276A Opt H06:** 1 kHz C-D measurement only (1V/300mV)

**HP 4276A Opt H07:** 1 kHz C-D measurement only (1V/500mV)

**HP 4277A Opt H03:** Programmable dc bias for high speed C-V measurement (1V/20mV, 1 MHz only)

**HP 4277A Opt H04:** Programmable dc bias for high speed C-V measurement (500mV/20mV, 1 MHz only)

**HP 4277A Opt H07:** High accuracy dc bias

Contact your nearest HP sales office for more information.

### Accessories

**Furnished accessories:** HP 16047A Direct Coupled Test Fixture

### Accessories Available

**HP 16064A:** Retrofit Kit for Comparator (HP 4276A/HP 4277A, Opt 002)

### Ordering Information

**HP 4276A LCZ Meter**

**HP 4277A LCZ Meter**

**Opt 001** Internal dc bias, 0 to  $\pm 40$  V

**Opt 002** 10-bin sorting for L/C/|Z| and go/no-go testing for D/Q, interfaceable with component handler.

**Opt W30** Extended repair service. (HP 4276A) See page 723.

**Opt W30** Extended repair service (HP 4277A) See page 723.

### Prices

\$5,400

\$7,440

+\$234

+\$815

+\$135

+\$185

- Built-in programmable dc bias sweep source with a voltage accuracy of 0.1%
- High speed C-V measurements: 10ms, 20ms, and 30ms/meas point

- 0.1% basic accuracy and 6 digit resolution for C measurement
- Automatic dc bias polarity control
- High reliability for production testing

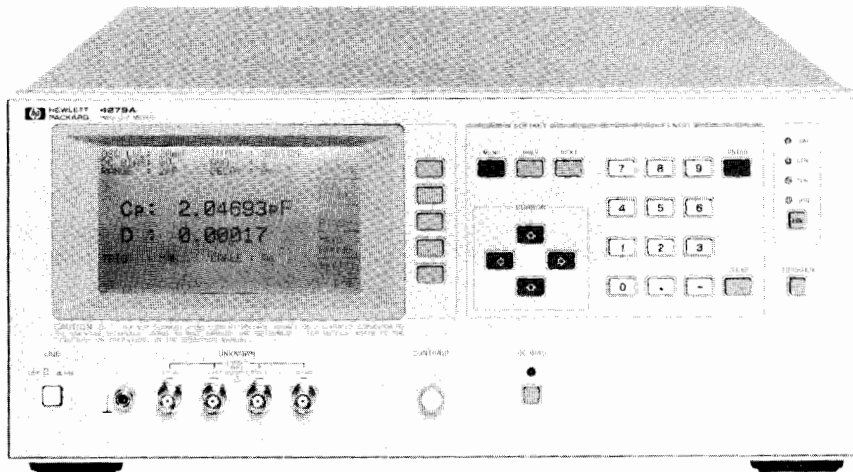

HP 4279A



### Description

The HP 4279A 1MHz C-V Meter offers the optimum solution for increasing quality and throughput when measuring the capacitance vs bias voltage characteristics of semiconductors. The HP 4279A measures capacitance over a range of 0.00001pF to 1280.00pF with a basic accuracy of 0.1% and a 6 digit display resolution, while sweeping the dc bias voltage. An internal, programmable dc bias sweep source with a 0.1% voltage accuracy throughout the  $\pm 38V$  range assures very low measurement error due to bias voltage uncertainty. It makes the HP 4279A ideal for the precise characterization and testing of varactor diodes, MOS diodes, etc.. Measurement time can be selected from three modes of 10ms, 20ms and 30ms/meas to maximize productivity. The HP 4279A's very fast ranging and high speed HP-IB data transfer capabilities reduce test time. The automatic bias polarity control feature allows quick selection of the correct polarity bias voltage for the device under test. This new function eases manual testing of samples in incoming/outgoing inspection and provides a simple method of polarity control for automatic test systems.

### Specifications

**Parameters measured:** C-D•Q•ESR•G

**Display:** 4, 5, 6 digits, selectable, maximum display 999999

**Measurement circuit modes:** Series and parallel.

**Ranging modes:** Auto, Manual and Program

**Measurement frequency:** 1MHz  $\pm 0.02\%$

**Test signal level (unknown terminal open):** 20mV, 50mV, 100mV, 200mV, 500mV and 1Vrms, selectable

**Measurement terminals:** 4-terminal pair

**Test cable length compensation:** 0m, 1m and 2m

**Error-correction:** OPEN and SHORT adjustments and STD and temperature compensation functions

**Measurement time:**

Mode	SHORT	MEDIUM	LONG
Time	10ms	20ms	30ms

**Ranging time:** Less than 3ms in program mode (unspecified)

**Trigger:** Internal, External and Manual

**Delay time:** 0 to 1000ms, programmable in 1ms steps

### Measuring range and accuracy

**C-D measurement range:** 0.00001pF to 1280.00pF;  
0.00001 to 9.99999D

**C measurement accuracy:** Specified at the front panel unknown terminals and the ends of standard 1m or 2m test leads (HP 16048A/B/D) when all of the following conditions are satisfied:

- (1) Ambient temperature is  $23^{\circ}C \pm 5^{\circ}C$  and temperature variance  $\leq 0.2^{\circ}C/min$
- (2) Warmup time  $\geq 10min$ .

- (3) OPEN, SHORT and temperature compensations have been made
- (4)  $D \leq 0.1$

Accuracies for C measurements in MEDIUM mode are given in Table 1 and are read as  $\pm(\% \text{ of reading} + \% \text{ of full scale value})$ . (Refer to the HP 4279A data sheet for complete accuracy specifications, including D/Q/ESR/G accuracies.)

C range	Test signal level			
	20mV	50mV	100mV	200mV-1V
1024pF 512pF 128pF	0.07%+0.03%	0.07%+0.03%	0.07%+0.03%	0.07%+0.03%
32pF				
8pF	0.06%+0.08%	0.06%+0.04%		
2pF	0%+0.3%	0%+0.15%	0%+0.1%	0.06%+0.04%

### DC bias

**Internal dc bias:** 0V to  $\pm 38V$

Bias voltage	Voltage step	Accuracy (at $23^{\circ}C \pm 5^{\circ}C$ )
$\pm(0.000-4.000)V$	1mV	$\pm(0.1\% \text{ of setting} + 1mV)$
$\pm(4.002-8.000)V$	2mV	$\pm(0.1\% \text{ of setting} + 2mV)$
$\pm(8.005-20.000)V$	5mV	$\pm(0.1\% \text{ of setting} + 3mV)$
$\pm(20.01-38.000)V$	10mV	$\pm(0.1\% \text{ of setting} + 10mV)$

**Bias voltage sweep:** Max. 51 sweep points can be programmed via HP-IB

**Auto bias polarity control:** Completed within 4ms after triggered (unspecified)

**External dc bias:** 0V to  $\pm 100V$  via rear panel connector

**HP-IB:** Standard. Remote control and ASCII or binary data output (packed data output when swept bias measurements are made.)

### General

**Operating temperature and humidity:**  $0^{\circ}C$  to  $55^{\circ}C$ ,  $\leq 95\%RH$  at  $40^{\circ}C$

**Power:** 100/120/220V  $\pm 10\%$ , 240V +5% -10%: 48 to 66Hz; 200VA maximum

**Size:** 177mmH x 426mmW x 498mmD (7" x 16.8" x 19.6")

**Weight:** Approximately 15kg

### Accessories Available

Refer to page 301.

### Ordering information

HP 4279A 1MHz C-V Meter

**Opt W30** Extended repair service. - See page 723

**Opt 003** 1% frequency shift

**Opt 009** Delete manual

### Price

\$9700

\$215

\$0

-\$36

# COMPONENT MEASUREMENT

## Digital LCR Meters

HP 4261A, 4262A

- Automatic balancing, ranging & circuit mode selection
- Test frequencies: HP 4261A, 120 (100) Hz and 1 kHz  
HP 4262A, 120 (100) Hz, 1 kHz and 10 kHz
- Versatile accessories and options
- High reliability

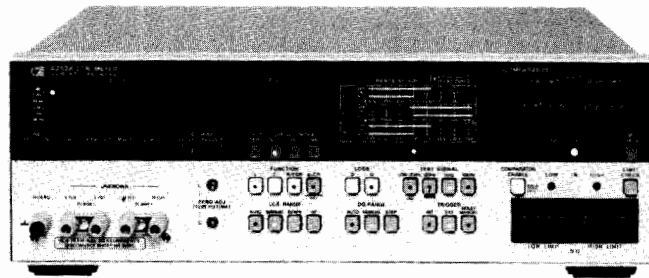

HP 4262A with Opt 004



HP 4261A

### Description

The HP 4261A and HP 4262A are 3½ digit LCR meters that meet today's requirements for component measurements. Both instruments feature fully automatic operation over wide measuring ranges. Simply select the measuring functions and one of the test frequencies, then insert the device to be measured. The instrument does the rest—automatically selecting the proper measuring range and equivalent circuit mode.

In addition to automatic measurements, the HP 4261A and HP 4262A provide high accuracy (0.2% reading), internal dc bias, and series and parallel equivalent circuit modes.

These relatively low cost and easy-to-use LCR meters are capable of a wide range of applications — measuring electrolytic/ceramic capacitors, filter coils, pulse transformers, internal resistance of dry cells and semiconductor junction capacitance, as well as ordinary LCR components. Extended features of these reliable instruments include optionally available HP-IB (HP 4262A) and BCD (HP 4261A) data output capabilities and a comparator option which is convenient for production line applications.

**Specifications** (refer to data sheet for complete specifications) Measurement ranges and accuracies: see table on this page. Accuracy applies over a temperature range of 23°C ±5°C (at 0° to 55°C, error doubles). 10 kHz and Q specifications are given only for the HP 4262A.

	HP 4261A	HP 4262A
Parameters measured	L-D, C-D R	L-D • Q, C-D • Q R (ESR), ΔLCR
Display	3-1/2 digits max. display 1900	3-1/2 digits max. display 1999
Basic Accuracy	0.2%	
Test frequency	120(100) Hz, 1 kHz ±3%	120(100) Hz, 1 kHz 10 kHz ±3%
Test signal level (typical)	1 V, 50 mV (Cp mode only)	
DC bias	Int	1.5 V, 2.2 V, 6 V ±5%, selectable
	Ext	0 to +30 V      0 to +40 V
Equivalent circuit modes	auto, parallel, series	
Ranging modes	LCR	auto, manual
	DQ	D only - fixed      auto, manual
Trigger	internal, external, manual	
Measuring terminal	5-terminal configuration	

**Deviation measurement (HP 4262A):** displays the difference between a stored value (that is, measured value when LCR switch is depressed) and subsequent measured data.

**Offset adjustments (HP 4262A):** front panel adjustments to compensate for stray capacitance (C: 0 to 10 pF) and residual inductance (L: 0 to 1 μH) of the test fixture.

**Self-test (HP 4262A):** automatically checks basic functions.

### General

**Measuring time (typical):** for a 1000 count measurement on a low loss component on a fixed range:

**1 kHz, 10 kHz:** C/L 220-260 ms, R 120-160 ms

**120 (100) Hz:** C/L 900 ms, R 700 ms

### Ranging Time

**1 kHz, 10 kHz:** 180 ms/range step

**120 (100) Hz:** 670 ms/range step

**Reading rate:** INT (internal trigger) approximately 30 ms between end of measurement cycle and start of the next cycle. EXT (external trigger) measuring cycle is initiated by a remote trigger input.

**Accessories available:** HP 16061A: test fixture, direct couple, 5-terminal; HP 16062A: test leads with alligator clips, 4-terminal (for low impedance measurements); HP 16063A: test leads with alligator clips, 3-terminal (for high impedance measurements).

### Ordering Information (HP 4261A \*1)

HP 4261A Digital LCR Meter	\$3,260
Opt 001 BCD Output (L/C/R and D simultaneously)	+\$244
Opt 002 BCD Output (L/D, C/D, R alternately)	+\$214
Opt 003 BCD Remote Control	+\$112
Opt 010 100 Hz Test Frequency	\$0
HP 16061A Test Fixture, Radial/Axial Lead devices	\$228
HP 16062A Test Leads, 4-wire	\$122
HP 16063A Test Leads, 3-wire	\$132

\*1: Options 001 and 002 are mutually exclusive.

### Ordering Information (HP 4262A \*2)

HP 4262A Digital LCR Meter	\$4,380
Opt 001 BCD Output	+\$430
Opt 004 Digital Comparator	+\$1,070
Opt 010 100 Hz Test Frequency	\$0
Opt 101 HP-IB Interface	+\$715
HP 16061A Test Fixture for Radial/Axial Lead Devices	\$228
HP 16062A Test Leads, 4-wire	\$122
HP 16063A Test Leads, 3-wire	\$132

\*2: Option combinations 101/001 and 101/004 cannot be ordered.

- Frequency range: 22 kHz to 70 MHz
- Q range: 5 to 1000

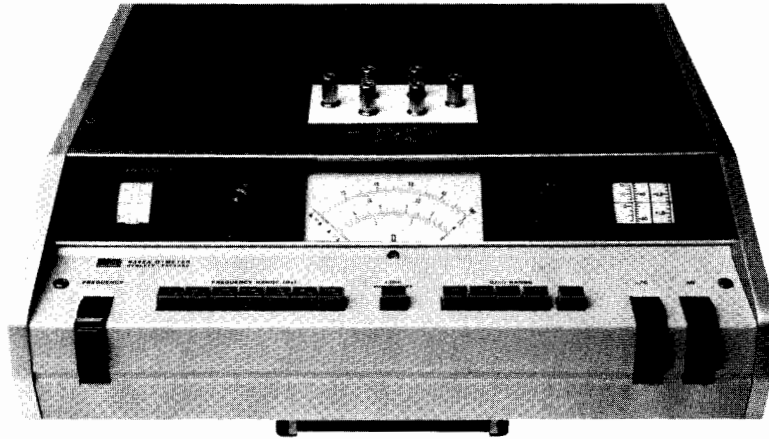

HP 4342A

## Description

The direct-reading expanded scale of the HP 4342A permits measurement of Q from 5 to 1000 and readings of very small changes in Q resulting from variation in test parameters. The HP 4342A is solid state with the elimination of specially matched, fragile thermocouple components.

The HP 4342A will measure dissipation factor and dielectric constant of insulating materials. The Q meter can measure coefficient of coupling, mutual inductance, and frequency response of transformers. RF resistance, reactance, and Q of resistors and capacitors can also be determined.

Pushbutton operation of frequency range and Q/ $\Delta$ Q range selection provides straightforward measurement. Automatic indication of meter scales, frequency dials and frequency multipliers are featured, adding to simplicity and reading speed.

## Specifications

### RF Characteristics

**RF range:** 22 kHz to 70 MHz in 7 bands: 22 to 70 kHz, 70 to 220 kHz, 220 to 700 kHz, 700 to 2200 kHz, 2.2 to 7 MHz, 7 to 22 MHz, 22 to 70 MHz.

**HP 4342A Opt 001:** 10 kHz to 32 MHz in 7 bands: 10 to 32 kHz, 32 to 100 kHz, 100 to 320 kHz, 320 to 1000 kHz, 1 to 3.2 MHz, 3.2 to 10 MHz, 10 to 32 MHz.

**RF accuracy:**  $\pm 1.5\%$  from 22 kHz to 22 MHz;  $\pm 2\%$  from 22 MHz to 70 MHz;  $\pm 1\%$  at "L" point on frequency dial.

**HP 4342A Opt 001:**  $\pm 1.5\%$  from 10 kHz to 10 MHz;  $\pm 2\%$  from 10 MHz to 32 MHz;  $\pm 1\%$  at "L" point on frequency dial.

**RF increments:** approximately 1% resolution.

### Q Measurement Characteristics

**Q range:** 5 to 1000 in 4 ranges: 5 to 30, 20 to 100, 50 to 300, 200 to 1000.

**Q accuracy:** % of indicated value: (at 25°C)

	HP 4342A & HP 4342A Opt. 001	HP 4342A
Q Freq.	22 kHz-30MHz	30 MHz-70 MHz
5-300	$\pm 7$	$\pm 10$
300-600	$\pm 10$	$\pm 15$
600-1000	$\pm 15$	$\pm 20$

**Q increments:** upper scale, 1 from 20 to 100; lower scale, 0.5 from 5 to 30.

**$\Delta$ Q range:** 0 to 100 in 4 ranges: 0 to 3, 0 to 10, 0 to 30, 0 to 100.

**$\Delta$ Q accuracy:**  $\pm 10\%$  of full scale.

**$\Delta$ Q increments:** upper scale, 0.1 from 0 to 10; lower scale, 0.05 from 0 to 3.

### Inductance Measurement Characteristics

**L range:** 0.09  $\mu$ H to 1.2 H, direct reading at 7 specific frequencies.

**L accuracy:**  $\pm 3\%$  after substitution of residuals (approx. 10 nH).

## Resonating Capacitor Characteristics

**Capacitor range:** main dial, 25 to 470 pF, vernier dial, -5 to +5 pF.

**Capacitor accuracy:** main dial,  $\pm 1\%$  or 1 pF, whichever is greater; vernier dial,  $\pm 0.1$  pF.

**Capacitor increments:** main dial, 1 pF from 25 to 30 pF, 2 pF from 30 to 200 pF, 5 pF from 200 to 470 pF; vernier dial, 0.1 pF.

## General

### Rear Panel Outputs

**Frequency monitor:** 170 mV rms min. into 50  $\Omega$ .

**Q analog output:** 0 to 1 V  $\pm 50$  mV dc after 15 minutes warmup, proportional to meter deflection. Output impedance approximately 1 k $\Omega$ .

**Over limit signal output:** contact closure at the rear panel. Relay contact capacity 0.5 A/15 VA.

**Over limit display time:** selectable, 1 s or continuously on, after limit exceeded.

**Temperature range:** 0°C to 50°C.

**Power:** 115 or 230 V  $\pm 10\%$ , 50-400 Hz, approximately 40 VA.

**Size:** 138 mm H x 425 mm W x 414 mm D (5 $\frac{1}{16}$ " x 16 $\frac{3}{4}$ " x 16 $\frac{1}{16}$ ").

**Weight:** net, 14 kg (31 lb); shipping, 18.45 kg (41 lb).

### Accessories Available

**HP 16014A series loss test adaptor:** designed for measuring low-value inductors and resistors and high-value capacitors.

**HP 16451A Dielectric Test Adapter:** designed for measuring the dielectric constant, capacitance and dissipation factor of insulating materials.

**HP 16462A Auxiliary Capacitor:** designed to extend the Q and L measurement capability of the HP 4342A Q Meter. It is especially useful for measuring small inductors at low frequencies.

**HP 16470A Reference Inductors:** A range of 20 inductors (any of which can be supplied separately) which can be used with the HP 4342A Q Meter when measuring the RF characteristics of capacitors, resistors, or insulating materials.

**HP 16470B Stable Inductors:** A set of 4 inductors (any of which are separately available) which can be used to compensate indicated Q values and/or instrumental variation in the maintenance of the HP 4342A Q Meter. They are usable over a range of 800 kHz to 50 MHz with excellent long-term temperature stability.

## Options and Accessories

**Opt 001** Frequency Range (10 kHz - 32 MHz)

**HP 16014A** Series Loss Test Adaptor

**HP 16451A** Dielectric Test Adapter

**HP 16462A** Auxiliary Capacitor

**HP 16470A** Reference Inductors, set of 20

**HP 16470B** Stable Inductors, set of 4

**HP 16470C** Complete set of 24 Inductors (HP 16470A

+ HP 16470B)

## Price

+\$335

\$173

\$715

\$660

\$3155

\$1730

\$4890

**HP 4342A Q Meter**

**\$7,200**

# COMPONENT MEASUREMENT

## Milliohmmeter/High Resistance Meter

HP 4328A, 4329A

- 20  $\mu\Omega$  resolution on 1 m $\Omega$  range
- Four terminal measurement
- Low test voltage

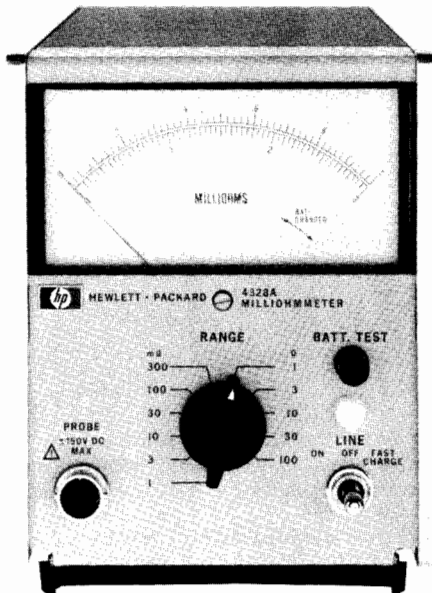

HP 4328A

### Description

HP's 4328A Milliohmmeter is a high sensitivity portable instrument for measurement of low resistances. The 1 m $\Omega$  to 100  $\Omega$  measuring range and 20  $\mu\Omega$  resolution make the HP 4328A ideal for measuring the contact resistance of switches, relays, and connectors and the resistivity of conductors and semiconductors. Series reactances of up to twice the full scale resistance will not affect the accuracy. The maximum voltage across a sample, with the instrument at the proper range, is less than 200  $\mu\text{V}$  peak. Even at incorrect range settings, the voltage across the sample will not exceed 20 mV peak.

The special probes that allow four-terminal measurement in two probes are furnished with the HP 4328A.

The basic HP 4328A is line operated but Opt 001 permits operation from rechargeable batteries for 15 continuous hours.

### Specifications

**Range:** 0.001 to 100 ohms full scale in a 1, 3 sequence.

**Accuracy:**  $\pm 2\%$  of full scale. No additional error is caused by series reactance of samples up to two times full scale.

**Measuring frequency:** 1000 Hz  $\pm 100$  Hz.

**Voltage across sample:** 200  $\mu\text{V}$  peak at full scale.

**Maximum voltage across sample:** 20 mV peak.

**Superimposed dc:** 150 V dc maximum (external source).

**Recorder output:** 0.1 V dc output at full scale, output resistance approx. 1 k $\Omega$ .

**Applied current (mA):** constant by range, 150/(full scale value in milliohms).

### General

**Power requirements:** 115/230 V  $\pm 10\%$ , 50 to 60 Hz, 1.5 VA.

**Weight:** 3.2 kg (7 lb).

**Size:** 155 mm H x 130 mm W x 280 mm D (6 $\frac{1}{32}$ " x 5 $\frac{1}{8}$ " x 11").

**Accessories furnished:** HP 16005A Probe, HP 16006A Probe, HP 16007A/B Test Leads and HP 16143A Probe Cable.

### Ordering Information

HP 4328A Milliohmmeter

Opt 001 Rechargeable battery operation

### Price

\$2,400

+\$132

- Wide range: 500 k $\Omega$  to  $2 \times 10^{16} \Omega$
- Selectable test voltages: 10 V to 1000 V

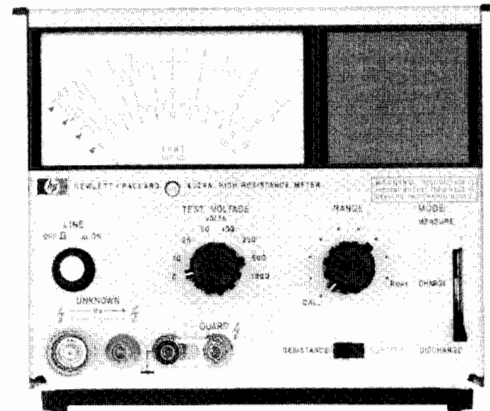

HP 4329A

### Description

The HP 4329A is a solid-state insulation resistance meter designed for easy, accurate and direct readings of the very high resistance values typically found in synthetic resins, porcelain, insulating oils and similar materials. It is also useful for measurements in electrical components such as capacitors, transformers, switches and cables. Seven fully regulated dc test voltages (between 10 and 1000 Vdc) are provided as test sources.

The HP 4329A is instantly convertible from ungrounded-to-grounded-sample operation via a simple relocation of the front panel ground strap from "guard" to "+" position.

The HP 4329A also has a current measurement capability. Minute currents as low as 0.05 pA can be readily measured.

The HP 16008A Resistivity Cell, designed for use with the HP 4329A, can safely, rapidly and conveniently measure the volume and surface resistivity of sheet insulation materials (maximum sample size: 125 mm W x 125 mm D x 7 mm H).

### Specifications

#### Resistance Measurement

**Range:** 500 k $\Omega$  to  $2 \times 10^{16} \Omega$ . (Depends on the test voltage).

**Accuracy:** total accuracy is determined by test voltage and range used. At low resistance end of each scale, accuracy is  $\pm 3\%$ , near center scale  $\pm 5\%$ , and near the specified upper limit on the meter scale (a quarter of full scale), accuracy is  $\pm 10\%$ . Accuracy is not specified above these limits. On all voltage ranges, if multiplier is set to Rmax., an additional  $\pm 3\%$  is included.

**Test voltages:** 10 V, 25 V, 50 V, 100 V, 250 V, 500 V and 1000 V  $\pm 3\%$ .

#### Current Measurement

**Range:**  $5 \times 10^{-14}$  to  $2 \times 10^{-5}$  A in 8 ranges.

**Accuracy:**  $\pm 5\%$  of full scale deflection (there can be an additional  $\pm 3\%$  error at the top decade).

#### General

**Recorder output:** 0 to 100 mV dc, proportional to meter deflection; 1 k $\Omega$  output resistance.

**Power:** 115/230 V  $\pm 10\%$ , 50-60 Hz, approximately 3 VA.

**Size:** 155 mm H x 198 mm W x 204 mm D (6 $\frac{1}{2}$ " x 7 $\frac{25}{32}$ " x 8 $\frac{25}{32}$ ").

**Weight:** 3.5 kg (7.7 lb).

**Accessory furnished:** HP 16117A Low Noise Test Leads.

**Accessory available:** HP 16008A Resistivity Cell.

### Ordering Information

HP 16008A Resistivity cell

HP 4329A High resistance meter

### Price

\$1,120

\$2,950



# COMPONENT MEASUREMENT

## Standard Capacitor Set and Decade Capacitor

HP 16380A, 16380C, 4440B

321

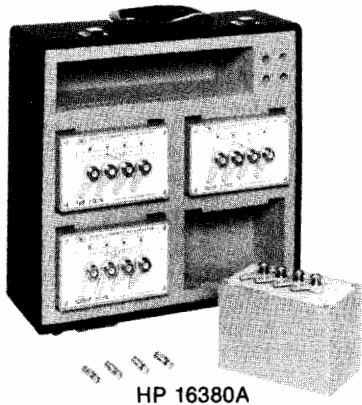

HP 16380A

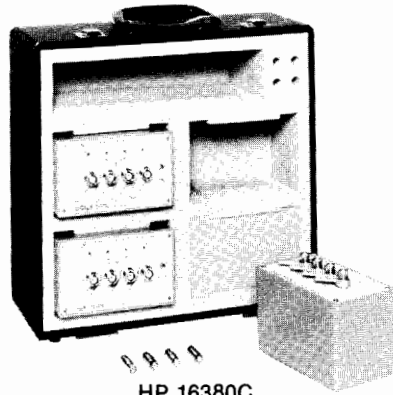

HP 16380C

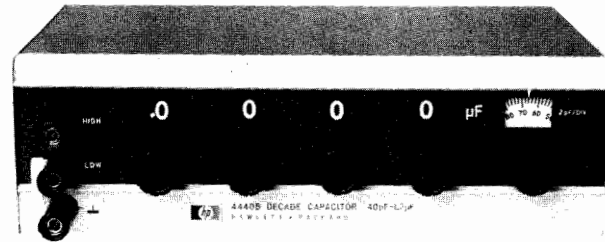

HP 4440B

### HP 16380A, HP 16380C Description

The HP 16380A and HP 16380C are precision standard capacitor sets that cover the range of 1 pF to 1  $\mu$ F in decade steps. The HP 16380A consists of four discrete air-dielectric capacitors with nominal values of 1 pF, 10 pF, 100 pF, and 1000 pF. Similarly, the HP 16380C consists of four discrete capacitors, but with solid dielectrics and with nominal values of 0.01  $\mu$ F, 0.1  $\mu$ F, and 1  $\mu$ F.

Both the HP 16380A and HP 16380C are furnished with test certification of 0.01% calibration accuracy. Capacitance stability with respect to time varies from capacitor to capacitor but is in the range of  $\pm 50$  or  $\pm 300$  ppm/year.

The HP 16380A and HP 16380C both have the four-terminal pair configuration to allow direct connection to any of Hewlett-Packard's many four-terminal pair impedance measuring instruments. The HP 16380A/C can be easily adapted to two-, three-, and five-terminal configurations.

### HP 16380A, 16380C Specifications (valid at 1 kHz, $23 \pm 5^\circ\text{C}$ )

#### HP 16380A

Capacitance	1 pF	10 pF	100 pF	1000 pF
Nominal Accuracy	$\pm 0.1\%$			
Calibration Accuracy	$\pm 0.01\%$			
Stability	$\leq 300$ ppm/yr*			
Dissipation Factor	$\leq 0.0001$			
Dimensions	112 mm (H) x 142 mm (W) x 88 mm (D)			
Weight	8.0 kg (includes case)			

\*Supplemental performance characteristics.

#### HP 16380C

Capacitance	0.01 $\mu$ F	0.1 $\mu$ F	1 $\mu$ F
Nominal Accuracy	$\pm 0.1\%$		
Calibration Accuracy	$\pm 0.01\%$		
Stability	$\leq 50$ ppm/yr		
Dissipation Factor	$\leq 0.0004$	$\leq 0.0005$	$\leq 0.0007$
Dimensions	117 mm (H) x 142 mm (W) x 88 mm (D)		
Weight	6.3 kg (includes case)		

### HP 4440B Description

The Hewlett-Packard 4440B Decade Capacitor is a high accuracy instrument providing usable capacitances from 40 pF to 1.2  $\mu$ F. Its 0.25% accuracy makes it an ideal aid for circuit design or as a working standard.

The use of silvered-mica capacitors in all four decades provides higher accuracy, lower dissipation factor and good temperature coefficient. An air capacitor vernier provides 100 pF (from 40 pF to 140 pF) with resolution of 1 pF. Capacitors are housed in a double shield in such a way that increased capacitance from two terminals to three terminals is held to 1 pF.

### 4440B Specifications

**Capacitance:** 40 pF to 1.2  $\mu$ F in steps of 100 pF with a 40 pF to 140 pF variable air capacitor providing continuous adjustment to better than 2 pF between steps.

**Direct reading accuracy:**  $\pm(0.25\% + 3 \text{ pF})$  at 1 kHz for three-terminal connection.

**Resonant frequency:** typical values of the resonant frequency are 450 kHz at 1  $\mu$ F, 4 MHz at 0.01  $\mu$ F and 40 MHz at 100 pF

**Dissipation factor:** for  $C \geq 1040$  pF, 0.001 max. at 1 kHz.  
for  $C < 1040$  pF, 0.005 max. at 1 kHz.

**Temperature coefficient:**  $< +70$  ppm/ $^\circ\text{C}$ .

**Insulation resistance:** 5 G $\Omega$  minimum, after 5 minutes at 500 V dc.

**Maximum voltage:** 42 Vdc or 30 Vrms.

**Weight:** net, 2.5 kg (5 1/2 lb); shipping, 3.6 kg (8 lb).

**Size:** 76 mm H x 264 mm W x 152 mm D (3" x 11" x 6").

### Ordering Information

**HP 16380A Standard Capacitor Set** (1 pF, 10 pF, 100 pF, 1000 pF) **Price** \$3,010

**HP 16380C Standard Capacitor Set** (0.01  $\mu$ F, 0.1  $\mu$ F, 1  $\mu$ F) **Price** \$4,585

**HP 4440B Decade Capacitor** **Price** \$1,800

# LIGHTWAVE TEST EQUIPMENT

## General Information

Probably the most remarkable fact about the evolution of fiber optics has been their rapid market growth. Design work began some twenty years ago, with trial projects carrying live telephone traffic being installed ten years later. Today, optical fibers are mass-produced for many applications worldwide.

### Technical Background

In general, all fiber-optic systems incorporate the following elements: transmitters, fibers, repeaters, and receivers, all of which are linked by connectors and/or splices.

Today, size, lifetime, reliability and ruggedness are major factors in the choice of sources and receivers for optical communication links.

Sources employ LEDs or LDs (laser diodes) to generate the optical output, while APDs or PIN diodes are used to detect the incident optical power on the receiving side.

### Optical Sources

LEDs are primarily used in short distance systems (<10km) with data rates below 100MHz. A limiting factor is their broad spectral width and the low coupling efficiency compared with an LD. Advantages are their simpler drive electronics, a higher reliability, and the lower price.

LDs, on the other hand, feature a small spectral width, an excellent coupling efficiency, and reach data rates up to 2 GHz. Thus LDs enable repeaterless data transmission over great distances (up to 150km).

### Optical Fibers

Inside the fiber, light is guided by total reflection at the core/cladding boundary due to corresponding differences in the refractive indices. Single-mode fibers are dominating today.

### Optical Receivers

To convert light back into an electrical signal for further processing, PIN diodes serve as receiving detectors when high data rates are required. This property is combined with favorable linearity and high stability. When increased sensitivity is of major concern, APDs are preferred. Due to their non-linearity, APDs are used only for purely digital applications, while PIN diodes can be used in both analog and digital systems.

### Lightwave Test Equipment

HP's line of lightwave test equipment offers new measurement capabilities for design and production engineers in a wide range of different application areas, from computer networks to high-speed, long-distance telecommunication links.

### Basic Test Instrumentation

Designers, manufacturers, and end-users of fiber-optic components, modules, or systems face a large variety of measurement

tasks. These tasks range from physical measurements, such as fiber geometry or numerical aperture, to system performance tests in the time or frequency domain.

HP offers the following basic lightwave test instruments.

HP 8140A optical loss test set

- Modular design
- Sources and sensors for all common wavelength ranges

HP 8145A optical time domain reflectometer

- Easy-to-learn softkey-guided menu concept
- Up to 28 dB dynamic range
- Non-volatile memory for more than 100 waveforms

HP 8151A pulse power meter

- Peak and average power measurements
- O/E transducer capability

HP 8153A lightwave multimeter

- Power sensor modules and source modules can be combined in any configuration
- Installed application software for long-term monitoring, fast data logging, fiber alignment and loss measurements

HP 8154B LED source

- Stability  $\pm 0.003$  dB/12h
- External modulation up to 1MHz

HP 8155A laser source

- Stability  $\pm 0.03$  dB/12h
- External modulation up to 850 MHz

HP 8157A optical attenuator

- High resolution of 0.01 dB
- > 36 dB typical return loss

HP 8158B optical attenuator

- High resolution of 0.01 dB
- Suited for both multimode and single-mode fibers

### High-Speed Instrumentation

In addition to the basic tools for making lightwave measurements, HP offers two high-speed lightwave instruments designed to measure lightwave modulation.

In most lightwave systems today, information is transmitted via an intensity modulated light carrier. HP's high-speed instrumentation consists of a lightwave signal analyzer, which measures the intensity modulation itself, and a lightwave component analyzer, which measures the modulation transfer function of lightwave components.

In addition to supporting the traditional modulation schemes, the high-speed instrumentation also has applications in state-of-the-art coherent communication systems.

### Lightwave Signal Analyzers

Until now, the only way to measure modulation on optical signals has been to use a custom optical design. But these custom systems are difficult to calibrate and often have poor sensitivity. The HP 71400C, 71401C, and

83810A lightwave signal analyzers combine HP's microwave and RF spectrum analyzers with a sensitive, wide-bandwidth optical converter to produce off-the-shelf instruments for analyzing the modulation on lightwave systems and components. With the HP 70810A module, you can measure modulated light on single-mode optical fibers from 1200 to 1600 nm or 750 to 870 nm with modulation rates up to 22 GHz. A fully calibrated display shows optical modulation and noise. You can accurately characterize semiconductor lasers, modulators, detectors, or any other device involved in modulated light.

### Lightwave Converter

With the HP-developed high-speed PIN photodetector and wide bandwidth preamplifier, the new HP 11982A converter offers unsurpassed performance and flexibility. This converter is dc-coupled and operates to beyond 15 GHz. It can be combined with high-speed oscilloscopes, spectrum analyzers, or as a general-purpose O/E converter for both digital and analog modulation. Time-on frequency-domain measurements can be easily made with built-in gain and optimized pulse response, extinction ratio, impulse response, eye diagrams, SONET, FDDI, and others.

### Lightwave Component Analyzer

A fiber-optic transmission system is made up of lightwave components ranging from lasers, photodiodes, and fiber to electrical amplifiers and transmission lines. As the information bandwidth of lightwave systems increases, it becomes important to characterize the modulation transfer function of each of these lightwave components. For example, the relaxation oscillation frequency of a laser limits the highest frequency it will pass, and the bias of a pin photodiode directly affects its speed.

The HP 8702B/8703A lightwave component analyzer and the HP 83420A lightwave test set (combined with an HP microwave network analyzer) provide the ability to measure all of these lightwave components. Measurements are made at fixed wavelengths (850 nm, 1300 nm, 1550 nm), while the modulation frequency is swept from 300 kHz to as high as 20 GHz. In this way, the modulation transfer function of a laser, the modulation bandwidth of a fiber, and the demodulation transfer function of a photodiode can be measured.

The lightwave coupler allows the system to make reflection measurements such as optical return loss of a photodiode or connector. The frequency domain information is used to calculate the time domain impulse response, allowing the location of multiple discontinuities as close as 1 cm apart.

# LIGHTWAVE TEST EQUIPMENT

## Optical Pulse Power Meter

Model 8151A with 81511A/81512A

323

- Peak and average power measurements
- Accuracy  $\pm 2.5\%$
- O/E transducer capability

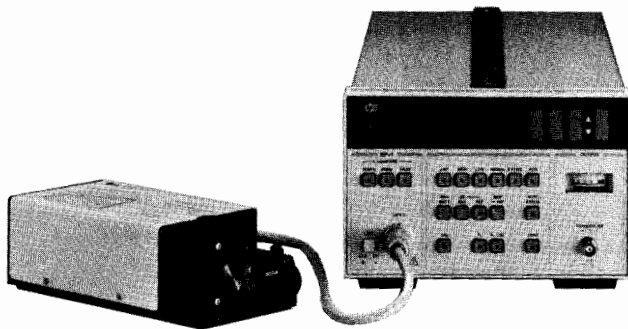

HP 81511A

HP 8151A

The HP 8151A, in combination with the HP 81511A/81512A Optical Heads, is a response measuring instrument for the level characterization of lightwave components, modules and systems. In addition to performing average power measurements, the HP 8151A enables the user to accurately determine upper and lower peak power levels - important in digital applications. This feature is also useful for applications where non-repetitive signals need to be evaluated, or where threshold levels are to be determined. The instrument's versatility is further enhanced by capabilities which allow the user to measure the amplitude, mesial power and extinction ratio of a signal.

The instrument's transducer has a frequency range of 250MHz (150MHz) and outputs an electrical signal which corresponds directly to the optical input waveform. The transducer output can be applied to other instruments for further processing, or displayed on an oscilloscope. By using the transducer, timing related measurements as functions of optical power (e.g. propagation delay versus power) are possible.

The HP 81511A Optical Head is for use at operating wavelengths between 550 and 950nm (calibrated for 850nm), and the HP 81512A for use between 900 and 1725nm (calibrated for 1300nm).

All heads carry interface adapters for fiber connectors and bare fibers.

A calibration grid on top of each optical head indicates typ. correction factors to be entered into the HP 8151A for operating wavelengths other than that for which the head is calibrated. Thus, the HP 8151A can be adapted to operate at any wavelength in the 550 to 1725nm range.

### HP 8151A, HP 81511A, HP 81512A Specifications

**Wavelength range HP 81511A:** 550 to 950nm, cal at 850nm

**HP 81512A:** 900 to 1725nm, cal at 1300nm

**Maximum core diameter: HP 81511A:** 200 $\mu$ m **HP 81512A:** 100 $\mu$ m

**Parameters measured:** high, low, and mesial power levels, amplitude, extinction ratio, average power

**Measurement range: HP 81511A:** +10dBm to -60dBm

**HP 81512A:** 0dBm to -50dBm

**Resolution:** 3 digits (Watts), 4 digits (dB)

**Calibration Accuracy: HP 81511A**  $\pm 3\%$

**HP 81512A**  $\pm 8\%$

**Accuracy:** (applies to linear display in Watt, rel. to calibration):

Range [dBm]	$\pm$ (of read + counts)	HI/Low Peak Power	
		Flatness	Average Power
+10 <sup>1</sup>	0.3 dB + 5	200 Hz - 9.99MHz: $\pm 0.4$ dB of ampl. <sup>2</sup> 10 MHz - 99.9 MHz: $\pm 0.6$ dB of ampl. <sup>2</sup>	0.1 dB + 5
0	0.3 dB + 30 <sup>2</sup>		0.1 dB + 5
-10	0.35 dB + 50		0.1 dB + 5
<b>Bandwidth</b>			
-20	0.2 dB + 10	10kHz	0.1 dB + 5
-30	0.2 dB + 10	6kHz	0.1 dB + 5
-40	0.2 dB + 20 <sup>2</sup>	1kHz <sup>2</sup>	0.15 dB + 10 <sup>2</sup>
-50	0.2 dB + 50 <sup>2</sup>	1kHz <sup>2</sup>	0.2 dB + 50 <sup>2</sup>
-60 <sup>1</sup>	0.3 dB + 80 <sup>1</sup>	4kHz <sup>1</sup>	0.2 dB + 50 <sup>1</sup>

1) not valid for HP 81512A 2) better specifications for HP 81511A

### Transducer

#### Conversion Accuracy<sup>4</sup> (for 30Hz squarewave):

Range [dBm]	Conversion Factor DC	Accuracy of Conversion	Bandwidth w/o Lowpass	rms Noise [dBm]
+10 <sup>1</sup>	1V/10mW <sup>1</sup>	$\pm 0.3$ dB $\pm 10$ mV <sup>1</sup>	DC-250MHz <sup>2</sup>	-20 <sup>1</sup>
0	1V/ 1mW	$\pm 0.3$ dB $\pm 10$ mV	DC-250MHz <sup>2</sup>	-20 <sup>3</sup>
-10	1V/ 1mW	$\pm 0.35$ dB $\pm 20$ mV	DC-250MHz <sup>2</sup>	-30
-20	1V/10 $\mu$ W	$\pm 0.3$ dB $\pm 20$ mV	DC-10 kHz	-40 <sup>3</sup>
-30	1V/ 1 $\mu$ W	$\pm 0.3$ dB $\pm 20$ mV	DC-6 kHz	-50 <sup>3</sup>
-40	1V/ 1 $\mu$ W	$\pm 0.3$ dB $\pm 20$ mV	DC-1 kHz <sup>3</sup>	-60 <sup>3</sup>
-50	1V/10nW	$\pm 0.3$ dB $\pm 50$ mV <sup>3</sup>	DC-1 kHz <sup>3</sup>	-60 <sup>3</sup>
-60 <sup>1</sup>	1V/ 1nW <sup>1</sup>	$\pm 0.3$ dB $\pm 20$ mV <sup>1</sup>	DC-4 kHz <sup>3</sup>	-70 <sup>1</sup>

1) for HP 81511A only 2)150MHz for HP 81512A 3)better specifications for HP 81511A

4) HP 81511A calibrated at 850nm, HP 81512A calibrated at 1300nm

### Pulse Response

**Transition time:**  $\leq 2$ ns full bandwidth ( $\leq 3$ ns for HP 81512A)

**Perturbations:**  $\leq 10\%$  of amplitude

### General

#### HP-IB capability

**Interface function:** SH1, AH1, T6, L4, SR1, RL1, PP0, DC1, DT1, CO

**Recalibration period:** 1 year

#### Environmental

**Storage temperature:** -40°C to +70°C

**Operating temperature:** 0°C to +55°C

**Humidity:** 95% R.H. from 0°C to +40°C

**Power:** 100/120/220/240 Vrms; +5%, -10%, 48 to 66Hz, 100VA max.

**Weight: HP 8151A:** net 8kg (17.5lbs), shipping 10kg (22lbs)

**HP 81511A:** net 1.3kg (2.9lbs), shipping 2kg (4.4lbs)

**HP 81512A:** same as for HP 81511A

**Size: HP 8151A:** 140mm(H) x 220mm(W) x 530mm(D) (5.7" x 9" x 21.6")

**HP 81511A:** 60mm(H) x 96mm(W) x 200mm(D) (2.5" x 3.9" x 8.2")

**HP 81512A:** same as for HP 81511A

### Ordering Information

**HP 8151A Optical Pulse Power Meter**

**Price**

**HP 8151A Optical Pulse Power Meter** \$9500

**Opt. W30** 3 years of customer return repair service \$190

**Opt. 907:** Front handle kit \$56

**Opt. 908:** Rack mount kit \$33

**Opt. 910:** Extra operating and service manual \$61

**HP 81511A Optical Head 550 to 950nm** \$4750

**Opt. W30** 3 years of customer return repair service (see page 723) \$100

**HP 81512A Optical Head 900 to 1725 nm** \$6750

**Opt. W30** 3 years of customer return repair service (page 723) \$150

Note: The HP 8151A cannot be used without an optical head and connector adapter. For connector adapters, see "Lightwave Test Accessories" below.

☎ For same-day shipment, call HP DIRECT at 800-538-8787.

### Accessories

#### Lightwave test accessories for HP 8151A and HP 81511A/81512A

Customer Connector	Adapter for Optical Head	Price
Diamond HFS1/KV	HP 81510A	\$350
NEC D4	HP 81510B	\$350
Bare Fiber, 50/125 $\mu$ m	HP 81510C	\$350
Bare Fiber, 200/250 $\mu$ m	HP 81510D	\$350
Amphenol 906 SMA	HP 81510E	\$350
FC	HP 81510G	\$350
Biconic	HP 81510H	\$350
F&G 3702	HP 81510J	\$350
Stratos 430	HP 81510K	\$350
AMP-SMA	HP 81510N	\$350
Optical Base Plate	HP 81510Q	\$220
Parallel Beam Adapter	HP 81510R	\$550
Blank Adapter	HP 81510Z	\$200

# LIGHTWAVE TEST EQUIPMENT

## Lightwave Multimeter

HP 8153A

- Power sensor modules and source modules can be combined in any configuration
- Traceable to NIST and PTB for accurate absolute power measurements
- Installed application software for long-term monitoring, fast data logging, fiber alignment and loss measurements
- Dump-to-plotter for easy documentation



DESIGNED FOR  
**HP-IB**  
SYSTEMS



HP 8153A

### HP 8153A Lightwave Multimeter

#### High Flexibility through Modular Design

The HP 8153A mainframe offers two slots for plug-in modules. Since all power sensor modules and laser source modules can be combined in any configuration, the instrument can be used as a one/two-channel power meter, as a loss test set or even as a one/two-channel laser source.

#### Power Sensor Modules Offer High Accuracy and Sensitivity

Four different power sensor modules, with sensitivities from  $-70$  dBm down to  $-110$  dBm, cover the 450 nm to 1700 nm wavelength range. Each is individually calibrated over its entire wavelength range and is traceable to NIST and PTB for precise optical power measurements. The excellent linearity and the high stability of the laser source modules provide the basis for precise determination of optical losses.

Sensor Module Specifications						
	HP 81530A	HP 81536A	HP 81531A	HP 81532A	HP 81533A +81520A	HP 81533A +81521B
Sensor element	Si		InGaAs		Si	Ge
Wavelength range	450-1020nm		800-1700nm		450-1020nm	900-1700nm
Power range	+3 to $-110$ dBm	+3 to $-70$ dBm	+3 to $-90$ dBm	+3 to $-110$ dBm	+10 to $-100$ dBm	+3 to $-80$ dBm
Display resolution (dB)	0.001dBm, 0.001dB					
Display resolution (Watt)	0.01pW	100pW	1pW	0.01pW	0.1pW	10pW
Applicable fiber type	9/125 to 100/140, (NA<0.3)				parallel beam, 9/125 to 100/140, (NA<0.3)	
Accuracy (at ref. cond.)	$\pm 2.5\%$ (600-1020nm) <sup>1</sup>		$\pm 2.5\%$ (1000-1650nm) <sup>1</sup>		$\pm 2.2\%$ (600-1020nm) <sup>2</sup>	$\pm 2.2\%$ (1000-1650nm) <sup>3</sup>
Total Uncertainty	$\pm 5\% \pm 0.5$ pW (600-1020nm) <sup>2</sup>	$\pm 5\% \pm 50$ pW (1000-1650nm) <sup>2</sup>	$\pm 5\% \pm 1.5$ pW (1000-1650nm) <sup>2</sup>	$\pm 5\% \pm 0.5$ pW (1000-1650nm) <sup>2</sup>	$\pm 4\% \pm 0.5$ pW (600-1020nm) <sup>4</sup>	$\pm 4\% \pm 50$ pW (1000-1650nm) <sup>4</sup>
Linearity 18°C to 28°C, const. temp. 0°C to 55°C, const. temp.	$\pm 0.015$ dB $\pm 0.3$ pW $\pm 0.05$ dB $\pm 0.5$ pW (0 to $-90$ dBm)	$\pm 0.015$ dB $\pm 30$ pW $\pm 0.05$ dB $\pm 50$ pW (0 to $-50$ dBm)	$\pm 0.015$ dB $\pm 1$ pW $\pm 0.05$ dB $\pm 1.5$ pW (0 to $-70$ dBm)	$\pm 0.015$ dB $\pm 0.3$ pW $\pm 0.05$ dB $\pm 0.5$ pW (0 to $-90$ dBm)	$\pm 0.15$ dB $\pm 0.5$ pW (+10 to $-80$ dBm)	$\pm 0.15$ dB $\pm 0.5$ pW (+3 to $-60$ dBm) <sup>5</sup>

<sup>1</sup> At the following reference conditions:  
- power level:  $-20$ dBm  
- continuous wave (CW)  
- fiber 50  $\mu$ m graded-index, NA=0.2, fully excited  
- ambient temperature 23  $\pm 5$ °C  
- connector Diamond HMS-10/HP  
- at day of calibration

<sup>2</sup> At the following operating conditions  
- power range as stated under linearity  
- fiber < 50  $\mu$ m, NA  $\leq 0.2$   
- for NA > 0.2 add 1%  
- ambient temperature 0 to 55°C  
- connector HMS-10/HP, FC/PC, DIN 47256, ST,  
for Bionic add 1%  
- within 1 year after calibration

<sup>3</sup> As <sup>1</sup> except parallel beam instead of fiber, 3mm diameter on detector.

<sup>4</sup> At the following operating conditions:  
- power range as stated under linearity  
- parallel beam 3mm diameter on detector  
- ambient temperature 23  $\pm 5$ °C  
- within one year after calibration  
For fiber applications use specific lens and add 0.5% uncertainty for the 850  $\pm 50$ nm, 1300  $\pm 50$ nm and 1550  $\pm 50$ nm range.

<sup>5</sup> add 0.012dB per °C between 40 and 55°C

### Laser Source Modules Offer High Stability

The source modules have very good short-term and long-term stability. The high output power can be internally attenuated up to 6 dB for accurate adjustment to the measurement requirements. A dual-wavelength source module for 1310 nm and 1550 nm enables device testing at both wavelengths. All sources output CW or pulse-modulated light (internal modulation at 270 Hz, 1 kHz or 2 kHz).

Laser Source Module Specifications				
	81551MM	81552SM	81553SM	81554SM
Central wavel. (nm)	850±10	1310±20	1550±20	1310/1550±20
Fiber type	50/125	9/125	9/125	9/125
Spectr. bandwidth (RMS)	<1.5nm	<2.5nm	<4nm	<2.5/4nm
Output power (dBm)	>-2dBm	>0dBm	>0dBm	>-1dBm
CW stability (15min, T=const)	±0.01dB	±0.003dB	±0.003dB	±0.005dB

### Built-in Software for Advanced Applications

Without an external controller, long-term power level monitoring up to 100 hours or fast data sampling with 50 measurements per second can be performed. For easy documentation, the measured curves can be dumped to any HPGL-plotter. Automatic loss measurements can be made simultaneously at two wavelengths, and procedures to optimize the amount of coupled light are supported as well.

HP 8153A STABILITY		15 MIN	
T avg	200.00 ms	T total	15.00 min
Cal Factor	0.000 dB	Samples	450
Wavelength	1310.0 nm		
Reference	0.820 dBm	30-448-90	12 45:42
		Max	0.0002 dB
		Min	-0.0002 dB
		Diff	0.0004 dB
		Avg	0.0000 dB

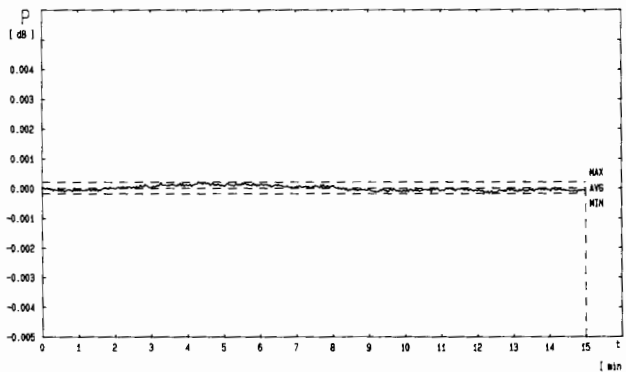

### Mainframe Specifications

**Power:** ac 100-240 Vrms, ±10%, 48-66 Hz, 35VA max.  
**Size:** 8.9H x 212.3W x 355mmD (3.5"x8.36"x14.0")  
**Weight:** net, 2.5kg (5.5lb); shipping, 4.5kg (9.9lb)

### Compatible with HP 8152A Optical Average Power Meter/HP 81520A/21B

HP 8152A/21B optical heads can also be used in combination with the HP 81533A optical head interface module. The HP 8153A lightwave multimeter is software compatible to the HP 8152A optical average power meter so that existing test programs can be utilized.

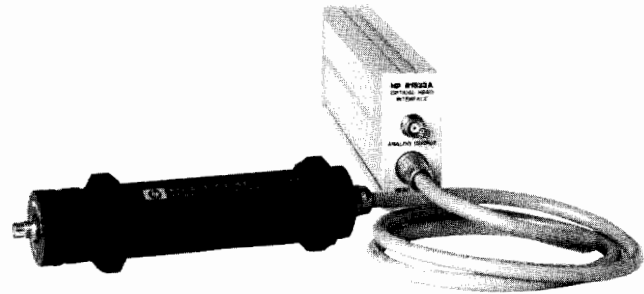

HP 81520A Optical Head with HP 8153A Optical Interface Module

### Ordering Information

Ordering Information	Price
HP 8153A mainframe	\$2600
Opt 907 front handle kit	+\$51
Opt 908 rack flange kit	+\$51
Opt 916 additional operating and programming manual	+\$65

### Power sensor modules<sup>4</sup>

HP 81530A Si, +3 to -110 dBm, 450-1020 nm	\$2450
HP 81531A InGaAs, +3 to -90 dBm, 800-1700 nm	\$2600
HP 81532A InGaAs, +3 to -110 dBm, 800-1700 nm	\$4300
HP 81536A InGaAs, +3 to -70 dBm, 800-1700 nm	\$1900
Opt 916 additional operating manual <sup>1</sup>	+\$30

### Optical heads<sup>5</sup>

HP 81533A optical head interface module <sup>2</sup>	\$820
Opt 916 Add. Operating Manual	+\$30
HP 81520A optical head, Si, +10 to -100 dBm, 450-1020 nm	\$1850
Opt W30 Extended repair service. See page 723.	+\$45
Opt W32 Calibration service. See page 723.	+\$390
Opt 916 Additional operating manual <sup>3</sup>	+\$30
HP 81521B optical head, Ge, +3 to -80 dBm, 900-1700 nm	\$2300
Opt W30 Extended repair service. See page 723.	+\$60
Opt W32 Calibration service. See page 723.	+\$285
Opt 916 Additional operating manual <sup>3</sup>	+\$30

### Laser source modules<sup>4</sup>

HP 81551MM 850 nm, multimode	\$5500
HP 81552SM 1310 nm, single-mode	\$5500
HP 81553SM 1550 nm, single-mode	\$8550
HP 81554SM 1310/1550 nm, single-mode	\$10900
Opt 916 Additional operating manual <sup>1</sup>	\$30

<sup>1</sup> different manuals for each module

<sup>2</sup> required to connect an optical head to the mainframe

<sup>3</sup> same manual for both optical heads

<sup>4</sup> one connector interface (HP 81000xT) per module required. See page 330

<sup>5</sup> for required lenses and adapters, see page 331

# LIGHTWAVE TEST EQUIPMENT

## Optical Attenuator

HP 8157A, 8158B

- High resolution of 0.01dB
- Short settling time (typ. 80ms)
- Suited for multimode and single-mode fibers (8158B)

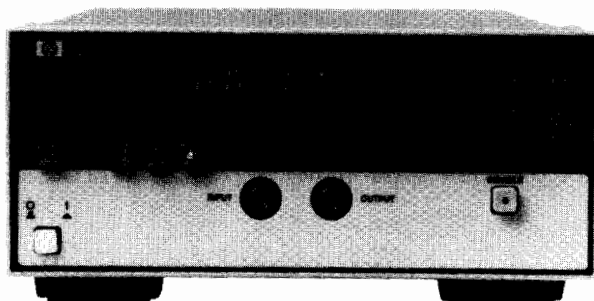

HP 8158B option 002 option 011

### HP 8158B Optical Attenuator

The HP 8158B optical attenuator is a fully programmable and highly flexible test instrument. Due to its state-of-the-art fiberless design, all applications employing fibers with a numerical aperture up to 0.3 are covered with one instrument. Multimode and single-mode (Options 002, 011 and 013 only) measurements can thus be easily performed.

### HP 8158B Specifications

All specs. are measured with Diamond HMS-10/HP connectors

#### Optical Characteristics

**Wavelength range:** 600-1200nm (opt. 001),  
1200-1650nm (opt. 002)

**Applicable fiber type:** all fiber types with an  $NA \leq 0.3$

**Attenuation range** (excluding insertion loss): 60.00dB

**Insertion loss** (incl. both connectors)

	single-mode 9 $\mu$ m <sup>2</sup>	multimode 50 $\mu$ m
worst case	<4.0dB	<2.0dB
typical	2.0dB	1.0dB

\*option 002 only

**Linearity:**  $\pm 0.4$ dB for single-mode,  $\pm 0.2$ dB for multimode

**Return loss** (incl. connectors): 14dB (fresnel)

### HP 8157A Optical Attenuator

The 8157A is a high performance single-mode attenuator for the 1200-1650nm wavelength range. Its excellent linearity, very high return loss and polarization insensitivity make it the ideal attenuator for bit error rate tests on optical systems for high data rates.

### HP 8157A Specifications

#### Optical Characteristics

All specifications are measured with Diamond HMS-10/HP connectors.

**Wavelength range:** 1200-1650nm

**Applicable fiber type:** single-mode fiber

**Attenuation range** (excluding insertion loss): 60.00dB

**Insertion loss** (incl. two HMS-10/HP connectors):  $\leq 4.0$ dB

**Linearity:**  $\pm 0.2$ dB (typical  $\pm 0.05$ dB)

**Return loss**  $> 33$  dB (HMS-10/HP),  $> 55$  dB internal

**Typical return loss:**

HMS-10/HP	PC	DIN47256	ST	BICONIC	FC	D4	SC
$> 36$ dB	$> 30$ dB	$> 33$ dB	$> 30$ dB	$> 30$ dB	$< 14$ dB	$> 40$ dB	$> 33$ dB

- Customer-exchangeable connector interfaces (8157A)
- $> 36$ dB typical return loss (8157A)

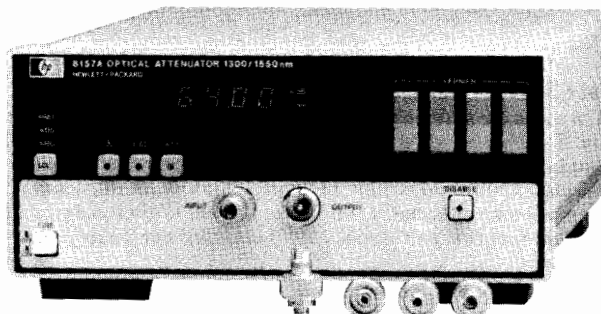

HP 8157A shown with user exchangeable connector interfaces (in the foreground)

### HP 8157A/HP 8158B Specifications

#### Display

**Display range:** 0.00 to 64.00dB

**Display resolution:** 0.01dB (min. step size)

**Repeatability** (of attenuation after a max. of 6 matings with same connector):

**single-mode** (9 $\mu$ m):  $< 0.2$ dB

**multimode** (50 $\mu$ m):  $< 0.1$ dB (HP 8158B only)

#### General

##### HP-IB Capability

All modes and parameters can be programmed

**Listen** (time to receive, verify and set up parameter)

**Output disable/enable, attenuation,  $\lambda$ :**  $< 20$  to 550ms (HP 8157A),  $< 20$  to 400ms (HP 8158B) (depending on actual setting/programmed parameter)

**HP-IB Interface Function Code:** SH1, AH1, T6, L4, SR1, RL1, PP0, DC1, DT0, C0

**Recalibration period:** 1 year

No warm-up time required if previously stored within operating temperature range.

##### Environmental

**Storage Temperature:**  $-40^{\circ}$ C to  $+70^{\circ}$ C

**Operating Temperature:**  $0^{\circ}$ C to  $+55^{\circ}$ C

**Humidity:**  $< 95\%$  R.H. from  $0^{\circ}$ C to  $+40^{\circ}$ C

**Power:** 100/120/220/240Vrms,  $\pm 10\%$ , 48-400Hz, 90VA max.

**Battery back-up** (for non-volatile memory): with instrument switched off, all current modes and data will be maintained for at least 10 years after instrument delivery

**Size:** 89H x 212.3W x 345D (3.5" x 8.36" x 13.6")

**Weight:** net, 5.3kg (11.7lbs); shipping, 9.6kg (21.2lbs)

#### Ordering Information

	Price
HP 8158B Optical Attenuator	\$2,400
Opt 001 600-1200nm (multimode only)	\$4,150
Opt 002 1200-1650nm	\$4,150
Opt 011 Diamond HMS-10/HP connector*	\$710
Opt 012 FC/PC connector* (multimode only)	\$1,020
Opt 013 DIN 47256 connector*	\$1,020
Opt 014 ST connector* (multimode only)	\$1,020
HP 8157A Optical Attenuator 1200-1650nm	\$9,050
HP 81000AI Diamond HMS-10/HP connector interfaces	\$260
HP 81000FI FC/PC connector interfaces	\$260
HP 81000GI D4 connector interfaces	\$260
HP 81000KI SC connector interfaces	\$260
HP 81000SI DIN 47256 connector interfaces	\$260
HP 81000VI ST connector interfaces	\$260
HP 81000WI Biconic connector interfaces	\$260
Opt 907 Front handle kit	\$50
Opt 908 Rack flange kit	\$50
Opt 916 Additional operating manual	\$31
HP 5061-9701 Bail handle kit	\$38

\*not exchangeable

For interface adapters, cables and accessories see "Lightwave Test Accessories" on page 330.

☎ For same-day shipment, call HP DIRECT at 800-538-8787.

# LIGHTWAVE TEST EQUIPMENT

## Optical Loss Test Set/Power Meter

HP 8140A

327

- Modular design
- Sources and sensors for all common wavelength ranges

- Large measurement range for loss and power
- Customer-exchangeable connector adapters

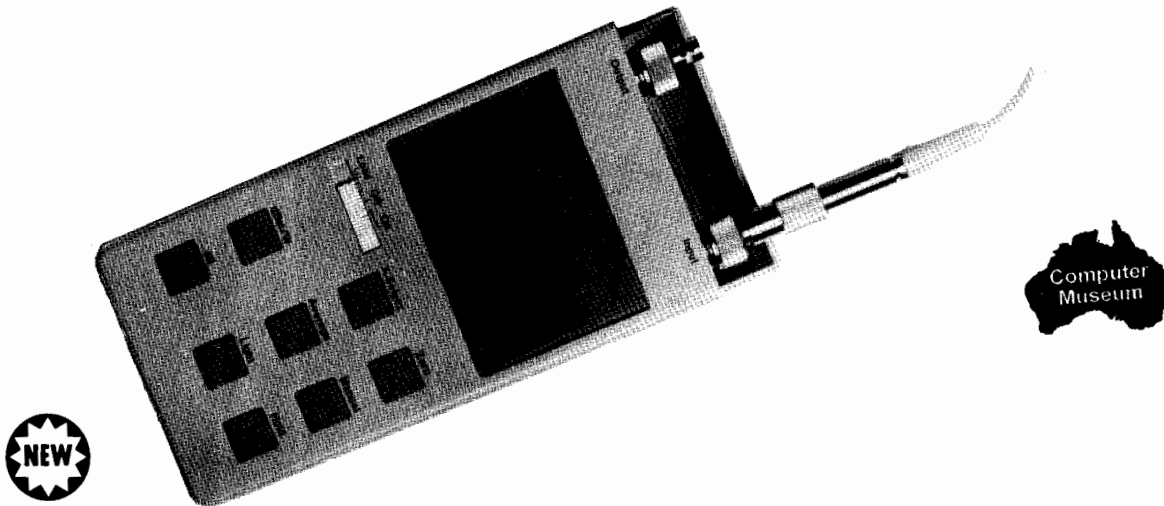

HP 8140A with 81401A sensor module and 81412A LED source module

### HP 8140A Optical Loss Test Set

The HP 8140A is a compact and lightweight instrument for handheld operation in installation and maintenance of optical links and component characterization. It may be configured as power meter, stand-alone source, or loss test set. In all configurations, it will provide performance and accuracy, usually only found in larger bench-type instrumentation.

As a power meter, it is an ideal tool for the measurement of the output power of transmitter modules, of power levels at the fiber end and the check for "dark" fibers.

The HP 8140A in a stand-alone source or loss test set configuration covers all wavelengths that are commonly used in datacom LANs and telecommunication networks. Power level stability and dynamic range meet the stringent requirements of long-distance links.

Its main applications include the insertion loss of optical passive components and the total link loss to check for power budgets.

To support all measurement needs in the field and on the bench, the HP 8140A loss test set features a modular and flexible design with exchangeable sensors, LED sources and connector interfaces. 5% measurement uncertainty and direct traceability to national standard laboratories such as NIST and PTB is guaranteed. A minimum set of keys ensure ease of operation.

#### Specifications

Power meter/sensor	HP 81400A	HP 81401A
Wavelength range	400-1100nm	750-1700nm
Fiber type	up to 100/140um	up to 100/140um
Measurement range	+10 to -70dBm 1pW to 10mW	+3 to -70dBm 1pW to 2mW
Noise floor	<3pWpp	<3pWpp
Measurement uncertainty	±5%	±5%
Calibrated wavelength	660/780/820/850nm	820/850/1300/1550nm
Sensor element	Si	InGaAs

#### Loss test set/ source

	HP 81411A	HP 81412A	HP 81413A
Wavelength [nm]	850±10	1300±20	1550±20
Spectral bandwidth [nm](FWHM)	<50nm	<140nm	<200nm
Output power (into 50/125µm)*	>-17dBm	>-20dBm	>-25dBm
Dynamic range (into 50/125µm)*	>53dB	>50dB	>45dB
Stability (15min, const temp, 0 to 40C)**:	±0.03dB	±0.03dB	±0.03dB

\*) typically 20dB less into single-mode fiber  
\*\*) after 5 min warm-up

Specifications apply to optical input signals emerging from optical fibers terminated with FC/PC type connectors. Accuracy specifications are measured with CW signals at -20dBm and 23±5°C and "ZERO" enabled prior to measurement.

**Display:** LCD, 4 digits, dB(rel), dBm, W, wavelength, low battery indication, backlit

**Display resolution:** 0.01dB (dB/dBm), 0.1% to 1% (W)

**Averaging:** 3 readings/s when OFF, floating average over 10 readings when ON

**Hold:** to hold actual measurement value

**Manual:** to hold selected range in Watt mode

**Zero:** to zero out all electrical offsets

**Auto power off:** 9 minutes after last key stroke (if internal batteries used)

**Size:** 185 H x 81 W x 41mm D (7.2"x3.2"x1.6")

**Weight:** net, 600g (incl. source, sensor, 4 batteries and 2 connector interfaces)

#### General

**Recalibration period:** 1 year

**Storage temperature:** -40°C to +70°C

**Operating temperature:** -10°C to +55°C

**Humidity:** <95% R.H. from 0°C to +40°C

**Mains adapter:** covering 100-250V

**Batteries:** 4 x AA (UM3), Alkaline Manganese, 1.9Ah

**Operating hours (typ.):** 20h (power meter mode)/8h (loss mode)

#### Ordering Information

HP 8140A optical loss test set (mainframe)

HP 81400A optical sensor 400-1100nm

HP 81401A optical sensor 750-1700nm

HP 81411A LED module 850nm

HP 81412A LED module 1300nm

HP 81413A LED module 1550nm

HP 81000A1/FI/GI/JI/KI/SI/VI/WI connector interface (each)

HP 8140CC carrying case

☎ For same-day shipment, call HP DIRECT at 800-538-8787.

#### Price

HP 8140A optical loss test set (mainframe)	\$580
HP 81400A optical sensor 400-1100nm	\$370
HP 81401A optical sensor 750-1700nm	\$770
HP 81411A LED module 850nm	\$790
HP 81412A LED module 1300nm	\$1,350
HP 81413A LED module 1550nm	\$1,900
HP 81000A1/FI/GI/JI/KI/SI/VI/WI connector interface (each)	\$130
HP 8140CC carrying case	\$110

# LIGHTWAVE TEST EQUIPMENT

## Optical Time Domain Reflectometer

HP 8145A option 002 (1300nm), option 003 (1550nm), option 023 (1300nm/1550nm)

- Dynamic range of 28 dB (1300 nm)/26 dB (1550 nm) with single-mode fiber
- Customer-installable laser modules (1300 nm or 1550 nm)
- Easy-to-learn softkey-guided menu concept
- Non-volatile memory for more than 100 waveforms
- Rugged and light-weight

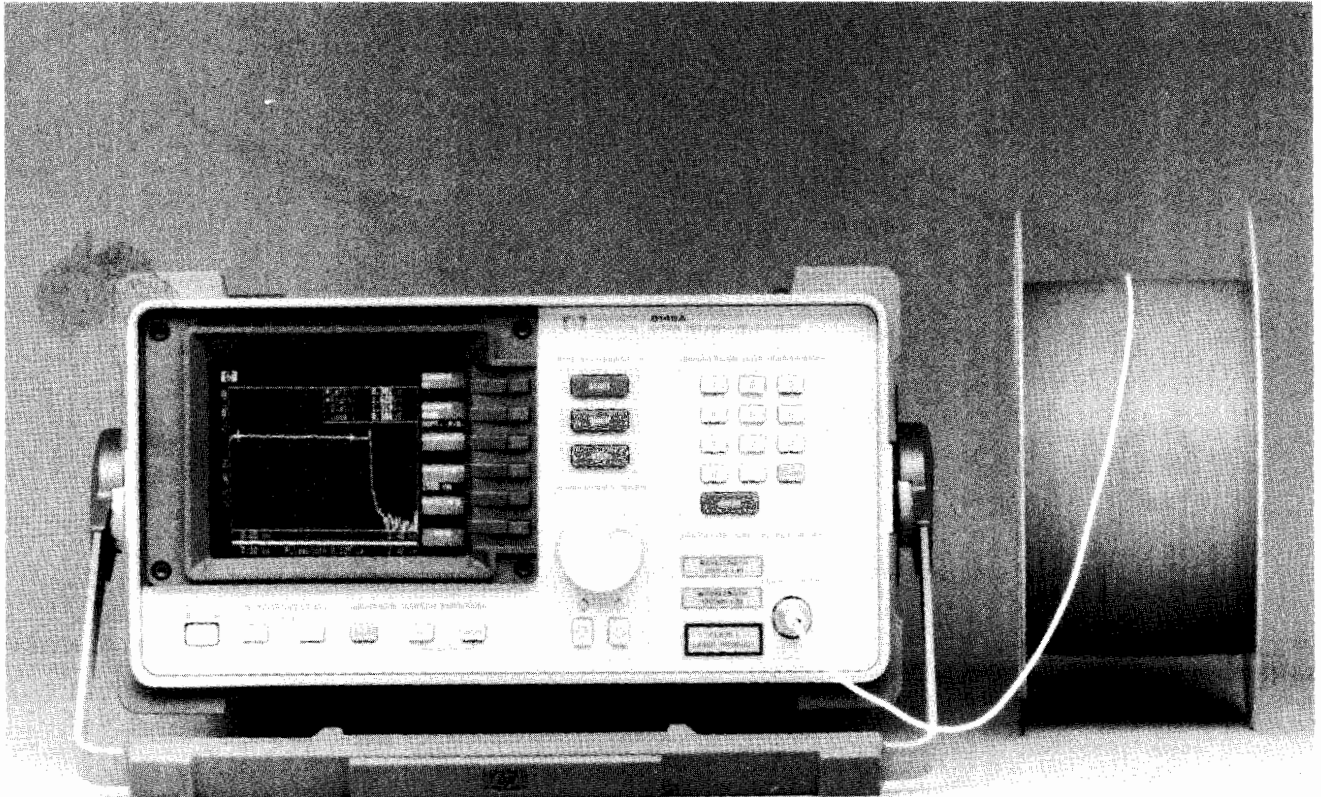

HP 8145A



The HP 8145A is a high-performance optical time domain reflectometer for field maintenance and bench applications. A unique data correlation technique increases the dynamic range to more than 28 dB at 1300 nm (26 dB at 1550 nm, regardless, whether the 1300 nm module is installed) single-mode and drastically reduces the measurement time.

For field maintenance, the HP 8145A features lightweight and rugged design. It can be operated on batteries (12 to 30 V dc), due to its low power consumption, or mains (90 to 260 V ac). Display resolution is 0.01 dB and 1m over the entire range of 200 km.

You no longer need unhandy dataloggers and external disk drives, which are sensitive to temperature changes, humidity, and dust. A plug-in non-volatile memory module (HP 81450A) stores more than 100 traces, each with all related measurement information. If immediate documentation is required, any data set can be directly printed or plotted out using a Thinkjet printer, Quietjet printer, or any HP-IB plotter without a controller.

For bench applications, including performance tests on optical fibers and cables in design and production, the HP 8145A OTDR offers an excellent set of features.

Any previously taken trace can be recalled as reference and compared against the presently sampled one. This ensures fast and easy detection of inhomogeneities and attenuation changes.

The HP 8145A has an easy-to-learn softkey guided operating concept. The user can blank unwanted keys for even easier operation. The OTDR is also fully HP-IB programmable.

By means of two optional laser modules the HP 8145A operates at either of the wavelengths 1300 nm, 1550 nm or both. The laser modules are user-installable.

Several exchangeable connector options are available, which allow easy access to the optical output for cleaning.



## HP 8145A Specifications

### Optical Characteristics (single-mode fiber)

	option 002	option 003	option 023
Wavelength	1300±30 nm	1540±30 nm	both wavelength
Dynamic range one way backscatter (SNR=1)	28 dB	26 dB	28/26 dB
Fresnel reflection (4%)	42 dB	40 dB	42/40 dB

Both wavelength options are user-installable. If both are installed in the HP 8145A, they are switch-selectable. Dynamic range figures are independent of number of options installed.

**Measurement time:** 22dB dynamic range after 10 seconds (16 dB after 1 second) at 1300nm on fiber without end reflection (worst case condition for break detection)

**Pulsewidth:** 125/250/500 ns/1/2/4/8 μs

**Output connector:** customer-exchangeable connector interfaces.

### Horizontal Parameters

**Start-km:** 0.000 - 199.500 km (see "Resolution")

**Span:** 0.500 km - 200.000 km (see "Resolution")

**Center-km:** 0.250 km - 199.750 km (see "Resolution")

**Resolution:** 1m in all three cases for parameter setting and distance read-out

**Accuracy:** ±8 m, uncertainty of fiber refractive index not included, for 125 ns pulsewidth

**Refractive index:** 1.4000 - 1.5999, in steps of 0.0001 settable

**Length correction:** 1.000 - 4.000, in steps of 0.001 settable. Serves to enter actual ratio of fiber/cable length into the OTDR

**Length unit:** switch-selectable between km, miles and feet

### Vertical Parameters

**Vertical scale:** 0.20 - 5.00 dB/div

**Resolution:** 0.01 dB for parameter setting, 0.001 dB for attenuation/loss read-out

**Linearity:** 0.05 dB/dB

**Zoom:** All combinations of horizontal and vertical parameters can be entered while the instrument is running. Serves to zoom in on any point of the waveform and allowing close examinations without interrupting the averaging process.

### Documentation

**Waveform memory:** 12 waveforms and related instrument settings can be stored in the HP 8145A in non-volatile memory and recalled. More than 100 waveforms and related instrument settings can be stored in each HP 81450A Memory Module and recalled. The modules contain non-volatile memory and plug into the rearpanel of the HP 8145A.

**ID codes:** An identification code of up to 38 alpha-numerical characters can be entered for each memory location. All ID codes are displayed when the directory is called up.

**Compare mode:** Presently displayed waveform can be compared against any previously stored one, if the horizontal parameters are identical. Zooming capability is provided.

**Hard copy:** Any displayed or previously stored waveform can be output directly to a Thinkjet or Quietjet printer, or any HPGL plotter.

**Instrument settings:** storage and recall of 9 user-selectable instrument settings, recall of 1 standard setting.

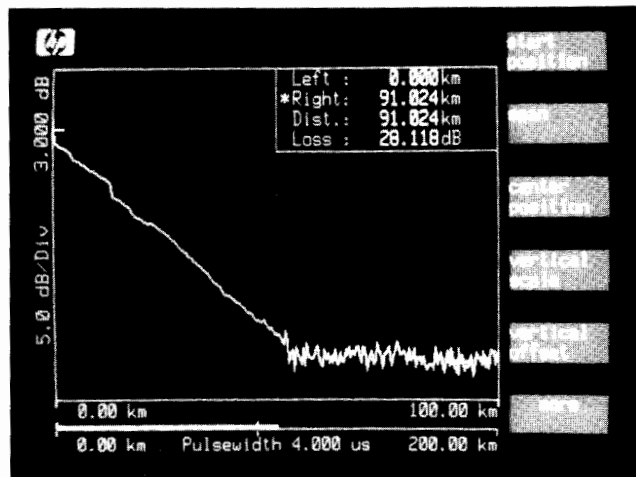

### General

**CRT:** 15 cm (6"), green

**Laser safety class:** Class 1

**Recalibration period:** 1 year

### HP-IB Capability

All modes and parameters can be programmed

**HP-IB interface function codes:** SH1, AH1, T5, L3, SR1, RL1, PP0, DC1, DT1, C0

### Environmental

Storage temperature: -40°C to +70°C

Operating temperature: -20°C to +65°C (-10°C to +55°C to meet specs)

Humidity: 95% R.H. from 0°C to +40°C

### Power

dc: 12 - 30 V dc, 80 W max

ac: 100/120/220/240 Vrms ±10%, 90 V Amax, 48-400 Hz

**Battery back-up** (for non-volatile memory): with instrument switched off, all current modes and data will be maintained for at least 10 years at 25°C temp.

**Dimensions:** 190 H, 340 W, 465mm D (7.5" x 13.5" x 18.3")

**Weight:** net, 16 kg (35.3 lbs); shipping, 22 kg (48.5 lbs)

### Ordering Information

HP 8145A optical time domain reflectometer	\$13,100
Opt 002 1300 nm	\$10,800
Opt 003 1550 nm	\$14,800
Opt 023 1300 nm/1550 nm	\$21,800
Opt 050 dc power cable	\$110
HP 81450A Memory module	\$1,100

The connector-interfaces are available as additional accessories.

For adapter cables and other accessories see "Lightwave Test Accessories" on page 331.

# LIGHTWAVE TEST EQUIPMENT

## Light Sources, Optical Isolators, Accessories

HP 8154B, 8155A, 81210LI, 81310LI

### Light Sources

- High stability
- User-exchangeable connector interfaces
- External modulation up to 850MHz (HP 8155A)

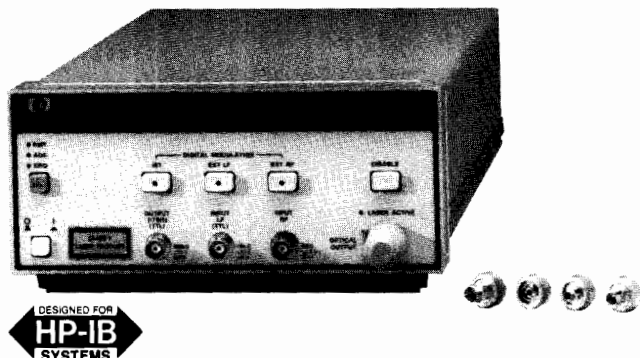

HP 8155A, option 002

### HP 8154B, 8155A Light Sources

The HP 8154B high-performance LED source is the ideal stimulus for every precise measurement on multimode fibers and components. It offers internal modulation at 270Hz and can be externally modulated up to 1MHz.

The HP 8155A is a highly stable laser source with external digital modulation capabilities up to 850MHz for performance tests on fast telecommunication links.

#### HP 8154B LED Source Specifications

	Option 001	Option 002	Option 003
Wavelength	850±30nm	1300±40nm	1550±40nm
Fiber Type	50/125µm	50/125µm	50/125µm
Output Power	>-17dBm	>-20dBm	>-23dBm
Stability (12h)	±0.03dB	±0.02dB	±0.02dB

#### HP 8155A Laser Source Specifications

	Option 002	Option 003
Wavelength	1300±30nm	1550±40nm
Fiber Type	9/125µm	9/125µm
Output Power	>-4dBm	>-4dBm
Stability (12h)	±0.03dB	±0.03dB

#### Ordering Information:

HP 8154B LED source mainframe*	\$2,500
Opt 001 850nm central wavelength	+\$1,400
Opt 002 1300nm central wavelength	+\$3,200
Opt 003 1550nm central wavelength	+\$4,500
Opt W30 Extended repair service. See page 723.	+\$50
Opt W32 Calibration service. See page 723.	+\$200
HP 8155A laser source mainframe*	\$2,950
Opt 002 1300nm central wavelength	+\$9,100
Opt 003 1550nm central wavelength	+\$11,000
Opt W30 Extended repair service. See page 723.	+\$65
<b>Options for both instruments</b>	
Opt 907 Front handle kit	+\$50
Opt 908 Rack flange kit	+\$50
Opt 914 Extra operating and service manual	+\$110
Opt 916 Add. operating and programming manual	+\$30

\*One connector interface (HP 81000xI) per mainframe required, see right column.

### Optical Isolators

Optical isolators offer very high peak-isolation of >60dB and a return loss of >60dB. Their polarization dependency is <0.2dB, and their insertion loss is <3dB. Isolators are available either with pigtailed (standard version) or with connectors (see options).

#### Ordering Information

HP 81210LI 1310±20nm wavelength range	\$4,350
HP 81310LI 1550±20nm wavelength range	\$4,350
Opt 001 input: bare fiber, output: Diamond HMS-10/HP	+\$430
Opt 010 input: Diamond HMS-10/HP, output: bare fiber	+\$430
Opt 011 input and output: Diamond HMS-10/HP	+\$870
Opt 002 input: bare fiber, output: PC	+\$430
Opt 022 input: PC, output: PC	+\$870

HP 81310LI

### Accessories

#### Bare Fiber Adapters

The HP 81000xB bare fiber adapters can be screwed onto the instruments/modules so that bare fibers can be directly connected to them. They are not suited for the HP 8158A attenuator and for the HP 81000AS/BS power splitters.

#### High Return-Loss Interface

This accessory can be used with all sensor modules for the HP 8153A lightwave multimeter or the HP 8140A loss test set. It eliminates the 4% Fresnel reflection at the fiber end and offers a typical return loss of 36dB with Diamond HMS-10/HP connector. One connector interface (HP 81000xI) is required.

#### Connector Interfaces

User-exchangeable connector interfaces enable easy cleaning of the instrument's front-end connector and also different connector types can be used with the same instrument.



Connector Interfaces

HP 81000RI

#### Through Adapter

Connect, two patchcords with Diamond HMS-10/HP connectors

#### Cleaning Kit

This kit contains all accessories you need to clean connectors, lenses or other optical surfaces. It is supplied in a rugged carrying case.

#### Ordering Information

<b>Bare fiber adapters</b>	<b>Price</b>
HP 81000AB Diamond HMS-10/HP	\$210
HP 81000FB FC/PC	\$210
HP 81000VB ST	\$210
HP 81000WB Biconic	\$210
<b>Connection interfaces</b>	
HP 81000RI High Return-loss interface	\$590
HP 81000AI Diamond HMS-10	\$130
HP 81000FI FC/PC	\$130
HP 81000GI D4	\$130
HP 81000JI SMA (multimode only)	\$130
HP 81000UI SC	\$130
HP 81000SI DIN 47256	\$130
HP 81000VI ST	\$130
HP 81000WI Biconic	\$130
<b>Other</b>	
HP 81000AM Through Adapter	\$360
HP 15475A Cleaning Kit	\$720

### HP Optical Power Splitters

The optical power splitters are mode and polarization insensitive, their split ratio is approximately 10:1. The HP 81000AS/BS accept single-mode and multimode fibers with a maximum numerical aperture of NA=0.3 and have factory-installed connector options. The HP 81010BS accepts single-mode fibers only and offers high return-loss for physical contact connectors. Typical values are 36dB for Diamond HMS-10/HP, 33dB for DIN 47256 and 30dB for PC.

### Attenuating Lens Adapter

With the HP 81220FL mounted onto an HP 81521B optical head, the output power of LED or laser chips, up to 20mW, can be measured precisely before the pigtail is attached. Antireflection coating on all optical surfaces guarantees minimum back reflections. The maximum acceptable numerical aperture is NA=0.5 in the wavelength range from 1200nm to 1650nm.

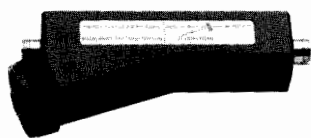

HP 81000BS



HP 81220FL

### Fixed Filter

To measure higher power levels, this 10dB-filter can be inserted between optical head and lens. Its wavelength range is 450nm to 1700nm.

### Filter Holder

This filterholder accepts all standard filters with one inch diameter and can be inserted between optical head and lens.

### Lenses

These lenses are required for HP 81520A/21B in combination with a connector adapter. They are not required if the signal is transmitted in parallel beam or if the HP 81220FL attenuating lens adapter is used.

OPTICAL HEAD      FILTER      LENS      ADAPTER

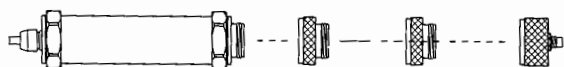

### Adapters for HP 81520A/21B Optical Heads

Connector adapters are necessary to use the HP 81520A/21B together with connectorized fibers. The HP 81000BA/CA bare fiber adapters allow you to measure light emitted by a bare fiber, with typically 0.02dB repeatability.

### Fiber Optics Handbook

This book is an excellent introduction and valuable reference guide to fiber-optic technology and measurement techniques. It offers basic information about optical components and systems, and it discusses methods for evaluating performance. It lists and illustrates the most important technical terms and helps in answering many questions.

### Ordering Information

Power splitters	Price
HP 81000AS <sup>1</sup> 600-1200nm wavelength range	\$1,600
HP 81000BS <sup>1</sup> 1200-1650nm wavelength range	\$1,600
Opt 011 Diamond HMS-10/HP connectors	+\$470
Opt 012 FC/PC connectors (multimode only)	+\$570
Opt 013 DIN 47256 connectors	+\$570
Opt 014 ST connector (multimode only)	+\$570
HP 81010BS <sup>2</sup> 200-1650nm, single-mode	\$2,850
<b>Lens Adapter</b>	
HP 81220FL Attenuating Lens Adapter	\$600
<b>Filter/holder</b>	
HP 81001FF fixed filter	\$170
HP 81001AF Filterholder	\$80
<b>Lenses</b>	
HP 81050AL 450-1020nm, multimode, NA<0.3	\$170
HP 81050BL 900-1700nm, multimode, NA<0.3	\$170
HP 81010BL 900-1700nm, single-mode NA=0.1	\$170
<b>Adapters for optical heads</b>	
HP 81000AA Diamond HMS-10	\$150
HP 81000BA Bare Fiber Adapter, 50/125µm	\$550
HP 81000CA Bare Fiber Adapter, 100/140µm	\$550
HP 81000DA Radial VFO-DF <sup>3</sup>	\$160
HP 81000FA FC/PC	\$160
HP 81000GA NEC D4	\$160
HP 81000JA SMA	\$160
HP 81000LA F&G 3702	\$160
HP 81000NA Stratos 430	\$160
HP 81000RA Non-Reflective Adapter <sup>4</sup>	\$600
HP 81000SA DIN 47256	\$160
HP 81000VF ST Adapter	\$160
HP 81000WA Biconic	\$160
HP 81000YA Diamond HFS-1	\$250
HP 81000ZA Blank Adapter (to be customized by user)	\$80
<b>Handbook</b>	
HP 5952-9654 Fiber Optics Handbook	\$20

<sup>1</sup> Select one connector option per HP 81000AS/BS

<sup>2</sup> Two connector interfaces (HP 81000xl) required

<sup>3</sup> For VFO-DF-slant single-mode connectors use lens HP 81050BL

<sup>4</sup> One connector interface (HP 81000xl) required

### Patchcords

One end of the 2m optical cable has the standard Diamond HMS-10/HP connector. The other end can be selected from the following table.

Customer Connector	Cable 10/125µm 2.5mm Ferrule		Cable 50/125µm 2.5mm Ferrule		Cable 62.5/125µm 2.5mm Ferrule		Cable 100/140µm 2.5mm Ferrule	
		Price		Price		Price		Price
Diamond HMS-10/HP	HP 81101AC	\$630	HP 81501AC	\$580	HP 81621AC	\$580	HP 81991AC	\$580
Bare Fiber	HP 81101BC	\$380	HP 81501BC	\$345	HP 81621BC	\$345	HP 81991BC	\$345
FC	HP 81101FC	\$630	HP 81501FC	\$580				
Radial VFO-DF slant	HP 81101DC	\$630						
	HP 81101EC	\$630						
straight	HP 81101GC	\$630						
	HP 81101IC	\$630						
NEC D4	HP 81101GC	\$630	HP 81501GC	\$580				
Amphenol 906 SMA			HP 81501HC	\$580			HP 81991HC	\$580
AMP-SMA			HP 81501JC	\$580			HP 81991JC	\$580
F&G 3702			HP 81501LC	\$580				
Stratos 430			HP 81501NC	\$580				
PC	HP 81101PC	\$870						
DIN 47256	HP 81101SC	\$630	HP 81501SC	\$580				
ST	HP 81101VC	\$630	HP 81501VC	\$580	HP 81621VC	\$580		
Biconic	HP 81101WC	\$730	HP 81501WC	\$580				
Diamond HFS-1			HP 81501YC	\$650				

# LIGHTWAVE TEST EQUIPMENT

## Lightwave Component Analyzer

HP 8702B, 8703A

- 300 kHz to 20 GHz Modulation Frequency
- Calibrated measurements of high-speed optical, electro-optical, and electrical components.

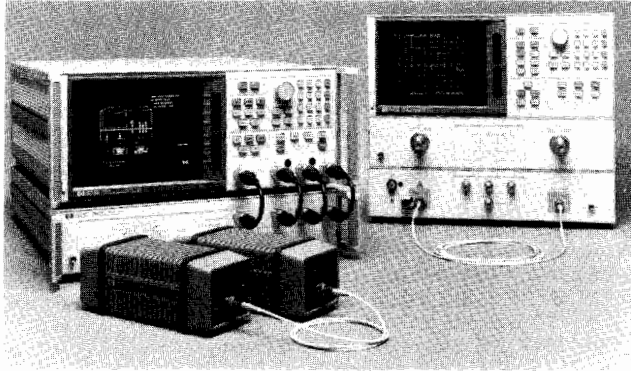

HP 8702B & 8703A

### Lightwave Component Analyzer

As the transmission rate or bandwidth of fiber optic systems is pushed upward, high frequency design considerations become key. Both the HP 8702B and 8703A measure each of the elements that transmit these wide bandwidths. They make calibrated measurements of lasers or LED transmitters, photodiode receivers, optical fibers, and the electrical components they work with. The lightwave component analyzers operate with a swept modulation frequency to precisely characterize how these components operate on the high-speed, information-bearing signal. Information on how each component responds independent of the others provides insight into how systems can be predicted and improved.

Both the HP 8702B and 8703A operate at a fixed wavelength and sweep the frequency of the intensity modulation signal over the bandwidth you select. The HP 8702B has transducers (lightwave source and receivers), which allow it to operate at 850, 1300, and 1550 nm. The HP 8703A can operate at 1300 and 1550 nm. These sources and receivers come with calibration data to allow calibrated measurements of the electro-optical components.

#### Measure Optical Components

Measurements can be made of such components as connectors, splitters, couplers, and lenses, as well as fiber itself. This yields modulation bandwidth, insertion loss, length, and optical return loss. In the distance-time domain, reflections can be located without the dead zone typical of OTDR type measurements. Transmission measurements can also be displayed in the distance-time domain to view the impulse or step response of the component. Delay and dispersion are easily viewed in this manner.

#### Measure Electro-Optical Components

Often the limiting elements in a fiber optic system are the electro-optical components (e.g., lasers, APD's, PIN photodiodes, and modulators), which convert the electrical information to optical or vice versa. The conversion efficiency or responsivity of these devices is a function of many variables. The characterized lightwave source and receiver in the lightwave component analyzer allows each of these devices to be uniquely tested. Data can be displayed in the frequency domain as the modulation frequency response or in the time domain as the step response.

#### Measure Electrical Components

When used to measure linear electrical components such as amplifiers, filters, and transmission lines, the lightwave component analyzers have the full measurement capability of a microwave network analyzer. Typical measurements are bandwidth, insertion loss/gain, phase, impedance, match, and group delay.

#### Measure Both Transmission and Reflection Characteristics

Complete characterization on component behavior depends on knowing how the signal is transmitted through it and how it is re-

- 850, 1300, or 1550 nm Operation
- Reflection measurements with < 1mm resolution
- up to 50 dB optical dynamic range.

flected back. For optical reflections, the lightwave component analyzers use a lightwave directional coupler to make the reflection measurements. Data can be presented in the modulation frequency domain or in the distance-time domain to locate and measure the source of the reflection. Because of the wide measurement bandwidth, single reflections can be located with < 1mm of resolution and up to 50 dB optical dynamic range and 100 dB electrical dynamic range. For electrical reflection measurements, the analyzer uses a test set to perform the measurement. Results, such as impedance, can then be displayed.

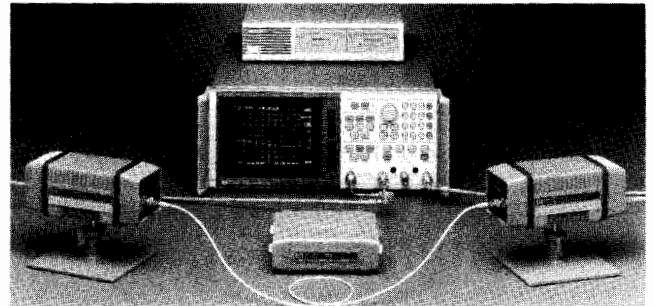

HP 8702B

### HP 8702B Lightwave Component Analyzer

Standard configuration requires an HP 8702B, an RF interface kit, a lightwave source, lightwave receiver, and fiber cable. For reflection measurements, a lightwave coupler is required.

#### HP 8702B Accessories

##### Lightwave Source Modules

All with directly modulated Fabry-Perot lasers.

- HP 83400A, 300 kHz-3 GHz, 1300 nm, 9/125 um fiber
- HP 83401A, 300 kHz-3 GHz, 1300 nm, 50/125 um fiber
- HP 83402A, 300 kHz-6 GHz, 1300 nm, 9/125 um fiber
- HP 83403A, 300 kHz-3 GHz, 1550 nm, 9/125 um fiber
- HP 83404A<sup>1</sup>, 300 kHz-3 GHz, 850 nm, 50/125 um fiber

##### Lightwave Receiver Modules

All with PIN photodiodes.

- HP 83410B, 300 kHz-3 GHz, 1300/ 1550 nm, 62.5/125 um fiber
- HP 83411A, 300 kHz-6 GHz, 1300/ 1550 nm, 9/125 um fiber
- HP 83411B, 300 kHz-6 GHz, 1300/ 1550 nm, 9/125 um fiber
- HP 83412A, 300 kHz-3 GHz, 850 nm, 62.5/125 um fiber

##### Lightwave Directional Couplers

A 3-port, directional coupler for making reflection measurements and monitoring transmission signals. The couplers have a nominal 3 dB coupling factor.

- HP 11890A 9/125 um fiber
- HP 11891A 50/125 um fiber

##### RF Interface Kit

HP 11889A

This kit contains the RF accessories required to operate the HP 8702 when a test set is not used. Contains a power splitter, a 20 dB pad, SMA accessories and adapters for the analyzer.

##### High Frequency Probe

HP 85024A

Performs in-circuit measurements. It's high impedance (0.7 pF in shunt with 1 MΩ) permits high frequency probing without adversely loading the circuit under test. See Page 239 for more information.

<sup>1</sup>The following sticker applies to the HP 83404A:



**S Parameter Test Set**

HP 85046A 300 kHz-3 GHz

HP 85047A 300 kHz-6 GHz

These test sets provide the capability to measure impedance and transmission characteristics of two port electrical devices in either forward or reverse direction with a single connection. The HP 85047A is required for 6 GHz operation.

**Calibration Kit**

HP 85033C 3.5 mm

Contains precision 3.5 mm standards used to calibrate the HP 8702 for electrical measurements of components with 3.5 mm or SMA connectors.

**Fiber Optic Cable**

HP 11871A PC Fiber Cable, 9/125 um, 1 meter

HP 11871B ST Fiber Cable, 9/125 um, 1 meter

HP 11871C Biconic Fiber Cable, 9/125 um, 1 meter

HP 11886A Interconnect Cable Kit, 9/125 um

HP 11887A Interconnect Cable Kit, 50/125 um

**Upgrade Kit**

HP 11876A

For upgrading an HP 8753A or 8753B network analyzers to an HP 8702A lightwave component analyzer.

**Ordering Information****HP 8702B** Lightwave Component Analyzer

Opt 006 6 GHz receiver operation

Opt 011 Delete time domain

Opt 802 Add Disk Drive &amp; Cable

**HP 83400A** Lightwave Source**HP 83401A** Lightwave Source**HP 83402A** Lightwave Source**HP 83403A** Lightwave Source**HP 83404A** Lightwave Source**HP 83410B** Lightwave Receiver**HP 83411A** Lightwave Receiver**HP 83411B** Lightwave Receiver**HP 83412A** Lightwave Receiver**HP 11890A** Lightwave Coupler**HP 11891A** Lightwave Coupler

HP 11871A PC fiber cable

HP 11871B ST fiber cable

HP 11871C Biconic fiber cable

HP 11886A Interconnect cable kit

HP 11887A Interconnect cable kit

HP 11889A RF Interface Kit

HP 85024A High Frequency Probe

HP 85046A S parameter test set

HP 85047A S parameter test set

HP 11876A Upgrade Kit

**Price**

\$33,600

+\$3,000

-\$4,800

+\$1,545

\$12,700

\$12,700

\$14,700

\$12,700

\$12,700

\$5,000

\$3,600

\$12,000

\$5,000

\$3,900

\$3,900

\$150

\$150

\$150

\$1,200

\$1,200

\$1,500

\$1,900

\$9,000

\$10,800

\$3,500

**HP 8703A lightwave component analyzer**

• 130 MHz to 20 GHz Modulation Frequency

• 1300 and 1550 nm operation

• FP and DFB lasers

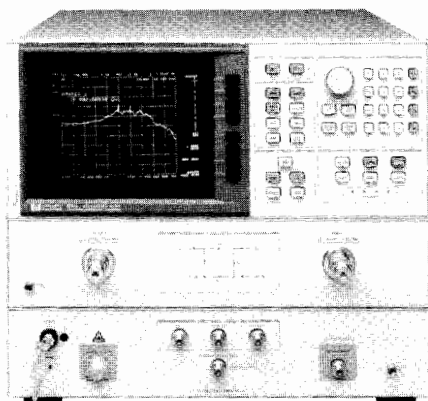

HP 8703A

**HP 8703A Lightwave Component Analyzer**

Standard configuration includes an internal 1300 nm Fabry-Perot (FP) laser and one 1300/ 1550 nm receiver. Optional 1300 or 1550 nm DFB internal laser sources are also available. The external lightwave source input (option 100) is used with the HP 83424A or 83425A<sup>2</sup> Lightwave CW Sources for additional 1550 or 1300 nm DFB wavelength flexibility.

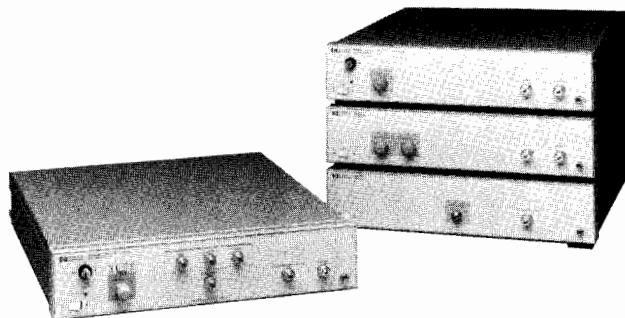
**HP 8703A Accessories****20 GHz lightwave test set, source, modulator and receiver**

HP 83420A, 83421A, 83422A, 83423A

**HP 83420A Lightwave Test Set**

Includes a 1300 nm FP laser, modulator, receiver, and directional coupler. Basic lightwave component analyzer tests from 130 MHz-20 GHz can be made when the HP 83420A is combined with an external controller and an HP 8510, HP 8720/H80, HP 8719/H80 or HP 8757 microwave analyzer system.

**20 GHz lightwave sources and receivers**

HP 83421A Lightwave Source

HP 83422A Lightwave Modulator

HP 83423A Lightwave Receiver

For standalone applications, these instruments have modulation frequency ranges of 130 MHz-20 GHz.

**Ordering Information****HP 8703A** Lightwave Component Analyzer

Opt 01X Select optical connector

Opt 100 External lightwave source input

Opt 210 1550 nm DFB laser

Opt 220 1300 nm DFB laser

Opt 300 Additional lightwave receiver

Opt 802 Add Disk Drive &amp; Cable

Opt 830 Add HP 3.5mm Cal Kit &amp; Cable

**HP 83424A** Lightwave CW Source- 1550 nm

Opt 100 External lightwave source input

**HP 83425A** Lightwave CW Source-1300 nm

Opt 100 External lightwave source input

**HP 83420A** Lightwave Test Set

Opt 01X Connector option

Opt 100 External lightwave source input

Opt 210 1550 nm DFB laser

Opt 220 1300 nm DFB laser

**HP 83421A** Lightwave Source

Opt 01X Connector option

Opt 100 External lightwave source input

Opt 210 1550 nm DFB laser

Opt 220 1300 nm DFB laser

**HP 83422A** Lightwave Modulator

Opt 01X Connector option

**HP 83423A** Lightwave Receiver

Opt 01X Connector option

Opt 300 Additional lightwave receiver

**Price**

\$105,100

\$0

+\$2,800

+\$15,000

+\$10,500

+\$10,900

+\$1,545

+\$5,100

\$27,500

+\$2,800

\$24,100

+\$2,800

\$47,500

\$0

+\$2,800

+\$15,000

+\$10,500

\$29,500

\$0

+\$2,800

+\$15,000

+\$10,500

\$20,000

\$0

\$13,500

\$0

+\$10,900

<sup>2</sup>The following sticker applies to the HP 83425A

# LIGHTWAVE TEST EQUIPMENT

## Lightwave Signal Analyzer for 800, 1300, 1550 nm

### HP 71400C, 71401C, 11980A

- Calibrated measurement of intensity modulation
- 100 kHz to 22 GHz bandwidth
- Single-mode fiber-optic input
- Reference-receiver capability
- Customer-exchangeable connector adapters
- High-performance electrical spectrum analyzer

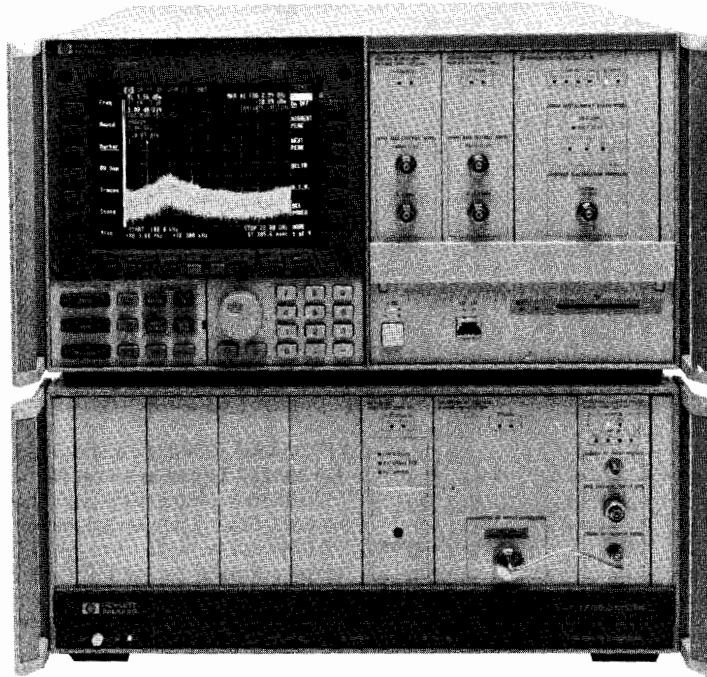

HP 71400C  
Option 850

### Calibrated Measurement of Intensity Modulation to 22 GHz

The HP 71400C combines a high-performance microwave spectrum analyzer with a wideband, highly sensitive optical receiver. This system measures modulated light on single-mode optical fibers simply and accurately from 100 kHz to 22 GHz. Optical modulation, noise, and average power are presented on a fully calibrated display. The system characterizes semiconductor lasers, laser transmitters, optical modulators, and detectors. With the addition of the HP 11980A fiber-optic interferometer and a gateable source, the system will measure linewidth and FM characteristics of distributed-feedback (DFB) and other single-mode lasers.

In addition to being a lightwave signal analyzer, this system also functions as a microwave spectrum analyzer with all the capability of the HP 71210C. And because the lightwave signal analyzer is part of the HP 70000 modular measurement system, its measurement capabilities can be expanded easily. One possibility, for example, is the addition of a tracking generator module for modulation response measurements to 18 GHz. (See pages 189 to 193 for more information.)

The HP 71400C system measures intensity modulation up to 22 GHz and operates over the wavelengths from 1200 nm to 1600 nm or, with option 850, 750 to 870 nm. It can achieve an optical sensitivity of better than  $-60$  dBm. The analyzer also offers average-power measurement, displayed as both a real-time vertical power bar and as a digital readout. Full calibration of both average power and modulation power makes this system a reference receiver for measuring and characterizing optical detectors and receivers.

For lower-frequency applications, the HP 71401C has an upper frequency limit of 2.9 GHz and the same functions and features as the HP 71400C. Both the HP 71400C and 71401C share three modes of

operation: lightwave optical, for display of optical watt or decibel units; lightwave electrical, for display of the fiber-optic input in equivalent electrical units; and microwave, for electrical spectrum analysis.

### Lightwave Measurement with the HP 70810A Module

The HP 70810A lightwave section is a 1/8-width lightwave-receiver module for the HP 70000 modular measurement system. The HP 70810A offers a built-in average power meter and an attenuator. It has a wavelength range of 1200 nm to 1600 nm, a detected modulation bandwidth of 100 kHz to 22 GHz, and a built-in RF amplifier of 32 dB that provides an optical sensitivity of  $-60$  dBm in a 10-Hz bandwidth. The module also features both optical- and electrical-input capability.

The HP 70810A may be used in stand-alone applications as a lightwave receiver housed in an HP 70000 mainframe. In this configuration, the electrical output is the detected intensity modulation in its amplified and uncorrected state.

If the lightwave module is ordered for an existing HP 70000 system that includes the HP 70908 or 70904 RF (input) section, option 20 offers extended system calibration and adjustment. In this case, the two modules are mated, tested, and calibrated together at the factory for optimum optical and electrical specification and amplitude flatness.

### New Option for 750 to 870 nm Measurement

For applications that require high-speed measurements in the 800 nm range, there is the new HP 70810A option 850. This option retains all the capabilities of the standard module but has a wavelength range of 750 to 870 nm. It is ideal for analysis of GaAs lasers or other high speed devices. Option 850 can be ordered for a system or as a standalone module.

# LIGHTWAVE TEST EQUIPMENT

Lightwave Signal Analyzer, 1200 to 1600 nm

HP 83810A, 11980A Accessory

335

- Portable
- 9 kHz to 22 GHz bandwidths
- Calibrated measurement of optical modulation power
- Optical marker function
- Interferometer for laser chirp measurements
- Exchangeable connector adapters

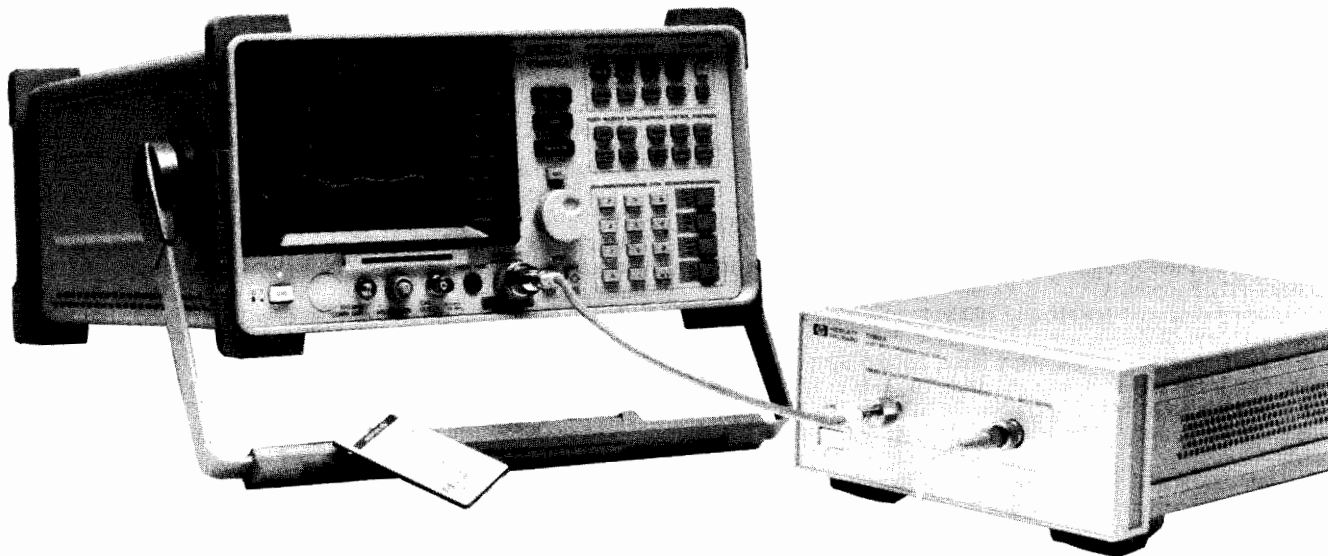

HP 83810A



## HP 83810A Portable Lightwave Signal Analyzer

This low-cost system has a wavelength range of 1200 to 1600 nm and bandwidths of 9 kHz to 22 GHz. It displays optical modulation power as a function of frequency and also measures and displays intensity modulation, distortion, and laser intensity noise. Maximum optical sensitivity is  $-54$  dBm at 100 MHz and  $-39$  dBm at 22 GHz. Frequency response is  $\pm 2.2$  dB at 100 MHz and  $\pm 3.2$  dB at 22 GHz. An optical marker function allows measurements to be expressed in optical or electrical units, logarithmic or linear. Frequency-response corrections and optical power are calculated automatically.

The HP 83810A consists of a fully functional HP 8593A portable microwave spectrum analyzer, the HP 11982A amplified lightwave converter, the HP 11982A option 001 lightwave frequency-response corrections and menus, an interface cable, and a type-N to SMA adapter.

The amplified lightwave converter combines a PIN photodetector with a low-noise preamplifier to improve the sensitivity of the measurement system. Conversion gain is 300 volts/watt and input optical reflections are 0.05%. The frequency response corrections included allow you to observe and measure changes in noise floor and distortion products when a laser is modulated, thus enabling you to predict the effects of laser noise.

Adding the HP 11980A fiber-optic Mach-Zehnder interferometer to the lightwave signal analyzer allows you to make linewidth, chirp, and frequency modulation (FM) measurements of single-line lasers.

### Input Connectors

An important feature of HP lightwave analyzers and accessories is their versatile input-connector system. A variety of optical screw-on connector interface adapters and patch cords for other connector systems are available. See ordering information on page 336.

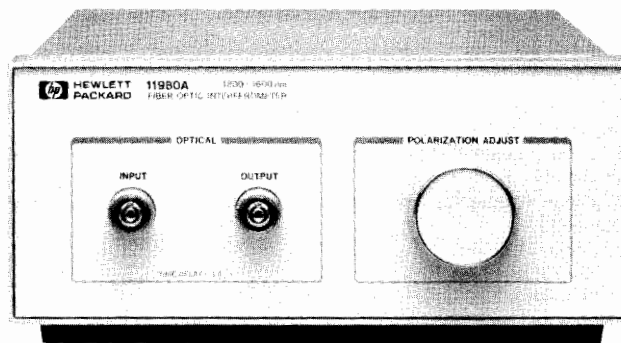

HP 11980A  
Option 005



## HP 11980A Fiber-optic Interferometer

This accessory for use with any of the HP lightwave signal analyzers is a Mach-Zehnder interferometer of fixed delay for measuring and characterizing single-linewidth lasers. Using a technique developed by Hewlett-Packard, the HP 11980A and an HP 71400 series or 83810A lightwave signal analyzer measure chirp and FM components on DFB lasers. They also make traditional measurements of laser linewidth. Together the interferometer, lightwave signal analyzer, and a gateable RF source permit the display of true power spectrum of single-frequency lasers, including intensity modulation linewidth and components of chirp caused by the intensity modulation.

The new option 005 replaces the standard 0.76 km of delay with 5.2 km to measure laser line width down to 30 kHz.

# LIGHTWAVE TEST EQUIPMENT

## Lightwave Signal Analyzer and Interferometer

HP 71400C, 71401C, 70810A, 83810A

### Specifications

#### HP 71400C

For general analyzer and electrical-mode specifications, refer to data sheets for the HP 71210C.

#### Optical

**Wavelength range:** 1200 nm to 1600 nm

**Input return loss (characteristic):** > 33 dB (optical).

#### Frequency

**Frequency range:** 100 kHz to 22 GHz

**Span:** 1 Hz to 22 GHz plus 0 Hz

#### Amplitude (at 25° C)

**Maximum input average power:** +30 dBm (optical);

**Modulated power:** +15 dBm (optical)

**Average power accuracy (at 1300 or 1550 nm):** ±0.65 dB (optical), ±0.5 nW, ±connector losses

**Modulated power accuracy (relative to average power) at 100 MHz:** ±1.0 dB (optical)

**Frequency response (relative to 100 MHz):** 100 kHz to 22 GHz, ±1.0 dB (optical)

**Displayed average optical noise level, optical dB (10 Hz Res BW, 0 dB input attenuation):** -51 dBm, 100 kHz to 1 MHz; -57 dBm, 1 MHz to 10 MHz; -62 dBm, 10 MHz to 100 MHz; -66 dBm, 100 MHz to 16 GHz; -60 dBm, 16 GHz to 22 GHz

#### Inputs

**Optical:** Choice of Diamond®, PC/FC, ST, Biconic or DIN single-mode fiber connectors (see Ordering Guide)

**Electrical:** SMA for optical bypass, 100 Hz to 22 GHz (see HP 71210C data sheet for other system inputs)

#### HP 71401C

Specifications for the HP 71401C are identical to those of the HP 71400C with the following exception:

**Frequency range:** 100 kHz to 2.9 GHz

#### HP 71400C/71401C Option 850

Specifications for these systems are identical to the standard systems with the following exceptions.

**Wavelength range:** 750-850nm

**Noise equivalent power:** Exactly 4 dB greater/range than standard system

#### HP 83810A

#### Optical

**Wavelength range:** 1200 to 1600 nm

**Input return loss (characteristic):** > 33 dB

**Frequency range:** 9 kHz to 22 GHz

#### Amplitude

**Optical frequency response, absolute, 10 dB attenuation, 20-30 C**

9 kHz-12.8 GHz +2.2 dB

12.4 GHz-19.4 GHz +3.0 dB

19.1 GHz-22.0 GHz +3.2 dB

**Displayed average optical noise level, characteristic, 1 kHz RBW, 30 Hz VBW, 0 dB attenuation**

400 kHz-6.4 GHz -54 dBm

6.0 GHz-12.8 GHz -48 dBm

12.4 GHz-19.4 GHz -44 dBm

19.1 GHz-22 GHz -39 dBm

**Harmonic distortion:** >25 dB below fundamental with modulated power < 120 dBm

**Maximum safe optical input power, average:** 10 mW

**Maximum operating optical input power, peak:** 1.5 mW

**Optical input connectors:** Single-mode fiber connectors such as Diamond HMS-10/HP, FC/PC, ST, Biconic, DIN

#### HP 70810A

#### Optical

**Wavelength range:** 1200 nm to 1600 nm

**Responsivity:** determined for each instrument to ±20%; typical value: 1200 V/W

**Input return loss (characteristic):** > 33 dB (optical)

#### Frequency

**Frequency range:** 100 kHz to 22 GHz

#### Amplitude

**Maximum input average power:** +30 dBm (optical)

**Modulated power:** +15 dBm (optical)

**Frequency response, corrected, relative to 100 MHz:** 100 kHz to 2.9 GHz, ±2.0 dB; 2.9 GHz to 22 GHz, ±5.0 dB

**Uncorrected:** typically < 25 dB roll-off 100 kHz to 22 GHz

**Noise equivalent power (optical dBm/√Hz):** -55, 100 kHz to 10 MHz; -66, 10 MHz to 100 MHz; -70, 100 MHz to 16 GHz; -64, 16 GHz to 22 GHz

#### Inputs

**Optical:** Choice of Diamond®, PC/FC, ST, Biconic or DIN single-mode fiber connectors (see Ordering Guide)

**Electrical:** SMA for optical bypass

#### HP 70810A option 850

Specifications for this module are identical to those of the standard HP 70810A with the following exceptions:

**Wavelength range:** 750 to 870 nm

**Responsivity, characteristic:** 500 V/W nominal value at 100 MHz

#### Amplitude

**Noise equivalent power (optical dBm/√Hz):** -51, 100 kHz-10 MHz; -62, 10 to 100 MHz; -66, 100 MHz to 16 GHz; -60, 16 GHz to 22 GHz

#### HP 11980A

This accessory is a Mach Zehnder interferometer for use with the HP 71400C, 71401C, and 83810A.

**Wavelength range:** 1250 nm to 1600 nm

**Optical insertion loss:** <8 dB (optical) at 1300 and 1550 nm

**Delay time:** typically 3.5 μsec; option 005, 25 μsec

#### Inputs

**Optical:** Choice of Diamond®, PC/FC, ST, Biconic or DIN single-mode fiber connectors (see Ordering Information).

#### Ordering Information

**HP 71400C** lightwave signal analyzer, 100 kHz to 22 GHz **Price** \$99,950

Order must also include one of connector options 011 to 015 below.

**Opt 850** \$0

**HP 71401C** lightwave signal analyzer, 100 kHz to 2.9 GHz \$69,120

**Opt 850** \$0

**HP 83810A** lightwave signal analyzer, 9 kHz to 22 GHz \$37,605

**Opt 001** frequency response correction/menus +\$800

**Opt 004** precision frequency reference +\$2,050

**Opt 301** AM/FM demod/TV sync trigger/fast time domain sweep +\$2,300

**HP 70810A** lightwave section, 100 kHz to 22 GHz \$18,800

Order must also include one of the connector options 011 to 015 below.

**Opt 850** \$0

**Opt 020** System adjustment and calibration (use HP 71400A specifications) +2,000

**Opt 098 or 099** System LO firmware upgrade \$0

**HP 11980A** fiber-optic interferometer \$6,450

Order must also include one of the connector options 011 to 015 below.

**Opt 005** \$3,300

#### Connector Options for the HP 71400C, 70810A, and 11980A

**Opt 011** Diamond HMS-10/HP connector interface \$0

**Opt 012** FC/PC connector interface \$0

**Opt 013** DIN 47256 connector interface \$0

**Opt 014** ST connector interface \$0

**Opt 015** Biconic connector interface \$0

#### Additional Interface Connectors

**HP 81000** AI Diamond® HMS-10/HP \$130

**HP 81000** FI FC/PC \$130

**HP 81000** SI DIN 47256 \$130

**HP 81000** WI Biconic \$130

**HP 81000** VI ST \$130

**HP 15475A** Cleaning Kit for Optical Surfaces \$120

☎ For same-day shipment, call HP DIRECT at 800-538-8787.





# LIGHTWAVE TEST EQUIPMENT

## Amplified Lightwave Converter, 1200 nm to 1600 nm

HP 11982A

337

- Optical-to-electrical converter
- Bandwidths from dc to 15 GHz
- High sensitivity
- Frequency- and time-domain measurements



HP 11982A



### HP 11982A Amplified Lightwave Converter

This wide-bandwidth, sensitive optical-to-electrical converter is ideal for characterizing lightwave systems and components. The converter combines a PIN photodetector with a low-noise dc-coupled preamplifier to create a general-purpose front end. It can be used with oscilloscopes, spectrum analyzers, and network analyzers. Measurements can be made in both the lightwave time and frequency domains.

The HP 11982A covers wavelengths from 1200 to 1600 nm and bandwidths from dc to 15 GHz. With 300 volts/watt conversion gain and 0.05% input optical reflections, it significantly improves the sensitivity of the measurement system. Each converter comes with a calibration chart of instrument-specific data for frequency response and responsivity. This enables you to make corrected, accurate measurements.

### Frequency Domain Measurements

Used with an electrical spectrum analyzer, the HP 11982A displays optical modulation power as a function of frequency. Intensity modulation, distortion, and laser intensity noise can also be displayed and measured. Using frequency-response corrections, you can predict and observe the effects of laser modulation on a system.

The option 001 memory card for the HP 11982A programs an HP 8591A RF or 8593A microwave spectrum analyzer with the frequency-response corrections and menus of the lightwave converter. This allows you to make easy, accurate, and corrected measurement to 22 GHz. A complete lightwave signal analyzer containing the lightwave converter and an HP 8593A spectrum analyzer is available. See page 335 for details.

Using this lightwave signal analyzer and an HP 11980A interferometer, you can measure linewidth with a gateable modulation source. Measurements of chirp and frequency modulation of single-line lasers can also be made. See page 335.

### Time Domain Measurements

Combining the dc-coupled HP 11982A with an HP 54120 series digitizing oscilloscope gives you capability for optical eye-pattern, extinction-ratio, and impulse-response measurements. Use the results to

verify optical and opto-electronic components, optical system level performance, and standards testing (such as SONET/SHD, FDDI, and ISDN) on telecommunications systems. The HP 11982A provides dc coupling--essential to extinction-ratio measurements--with 20 dB electrical gain and 15 GHz bandwidth. The HP 54120 series has a wide range of bandwidths, low jitter, and the averaging and persistence features needed for time domain measurements.

### Specifications

- Wavelength (characteristic):** 1200 to 1600 nm
- Bandwidth (characteristic):** dc to 15 GHz (optical)
- Full width half maximum:** 29.4 ps
- Conversion gain (dc responsivity):** 300 V/W, nominal
- Noise equivalent power (characteristic):** 30 pW/ $\sqrt{\text{Hz}}$
- Input return loss (characteristic with HMS 10/HP connector):** >33 dB
- Aberrations (characteristic):** <20% peak to peak
- Corrected frequency response, dc to 22 GHz:** +2.2 dB at 20-30 C
- Harmonic distortion (output <-10 dBm):** >41 dB below fundamental
- Maximum safe optical input power, average:** 10 mW
- Maximum operating optical input power, peak:** 1.5 mW
- Output voltage range (into 50 ohms):** >700 mV
- Output offset voltage (into 50 ohms):** <1 mV

### Ordering Information

	<b>Price</b>
HP 11982A amplified lightwave converter	\$12,500
Opt 001 frequency response correction/menus	+\$800
Connector options	\$0
Opt 011 diamond HMS-10	\$0
Opt 012 FC/PC conn interface	\$0
Opt 013 din conn interface	\$0
Opt 014 st conn interface	\$0
Opt 015 biconic connector interface	\$0
Opt 910 extra user manual	+\$90

# TRANSCEIVER TEST EQUIPMENT

## Automated Test Systems

HP 8953A, 8955A, 8957S

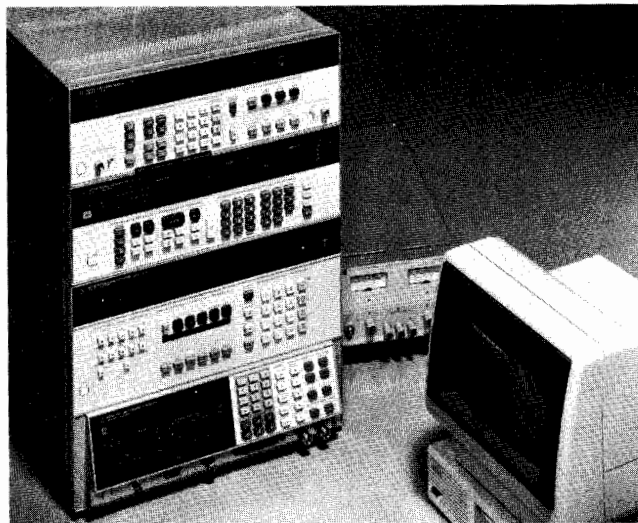

### Transceiver Test Systems

Hewlett-Packard's transceiver test product line was designed to offer maximum flexibility, modularity and expandability to the mobile communications market. All systems are based on three "designed for systems" instruments: the HP 8656B Synthesized Signal Generator, the HP 8903B Audio Analyzer, and the HP 8901A/B Modulation Analyzer. These products together perform the majority of in-channel tests on any AM or FM transceiver. Combining these three basic building blocks, together with a programmable interface for system integration, creates a modular solution that is flexible enough to meet your needs today and tomorrow. These systems then can be automated using one of the many software packages available for the Series 300 and Vectra computers.

Based on the three basic measurement instruments and our system interface product line, Hewlett-Packard has created three separate test systems: the HP 8953A Transceiver Test Set, the HP 8955A RF Test System and the HP 8957S Cellular Radio Test System. From these beginnings, you can add or change instruments depending on your requirements.

#### HP 8953A

The HP 8953A Transceiver Test Set is Hewlett-Packard's lowest-priced system. It combines the measurement power of the three basic measurement instruments with the HP 8954A Transceiver Interface to create a solution capable of performing the majority of in-channel tests and expandable enough to meet all but the most demanding of testing requirements.

#### Ordering Information

<b>HP 8953A</b> Transceiver Test System (consisting of:)	<b>Price</b> \$31,900
<b>HP 8901A</b> Modulation Analyzer	
<b>Opt 001</b> RF output connectors on rear panel only	
<b>Opt 002</b> High stability time base	
<b>HP 8656B</b> Synthesized Signal Generator	
<b>Opt 002</b> RF output connectors on rear panel only	
<b>HP 8903B</b> Audio Analyzer	
<b>Opt 001</b> RF output connectors on rear panel only	
<b>Opt 010</b> 400 Hz high pass filter	
<b>Opt 051</b> CCITT weighting filter	
<b>HP 8954A</b> Transceiver Interface	
<b>HP 8498A</b> Attenuator	
<b>Opt 030</b> 25 watt, 30 dB	
Cables and connectors	

#### HP 8955A

The HP 8955A RF Test System is a powerful and versatile system developed for designers, manufacturers and users of RF communication equipment. It provides a flexible combination of instruments for testing transmitters, receivers, subassemblies and modules in the frequency range from 150 kHz to 1000 MHz. The basic system consists of the three basic measurement instruments and the HP 436A Power Meter for increased measurement accuracy. The instruments are then integrated using the HP 8956A System Interface. The system also includes a cabinet, side table and comprehensive documentation.

Before a system is shipped, it is assembled and tested at the factory. This includes installing the instruments into the rack and thoroughly testing them as a system, ensuring that the HP 8955A meets its specifications.

#### Ordering Information

<b>HP 8955A</b> RF Test System (consisting of:)	<b>Price</b> \$61,150
<b>HP 8901A</b> Modulation Analyzer	
<b>Opt 001</b> RF connectors on rear panel only	
<b>HP 8656B</b> Synthesized Signal Generator	
<b>Opt 001</b> high stability time base	
<b>Opt 002</b> RF connectors on rear panel only	
<b>HP 8903B</b> Audio Analyzer	
<b>Opt 001</b> RF connectors on rear panel only	
<b>Opt 010</b> 400 Hz high pass filter	
<b>Opt 051</b> CCITT weighting filter	
<b>HP 8956A</b> System Interface	
<b>HP 436A</b> Power Meter	
<b>HP 8482A</b> Power Sensor	
System Cabinet	
Cables and connectors	

#### HP 8957S

The HP 8957S Cellular Radio Test System combines the three basic measurement instruments with the HP 8958A Cellular Radio Interface. This system will perform all signaling necessary to test AMPS and TACS compatible cellular radios. By adding the HP 11799A Signaling Box, the system's capabilities can be increased to include NMT cellular radios.

#### Ordering Information

<b>HP 8957S</b> Cellular Radio Test System (consisting of:)	<b>Price</b> \$0
<b>HP 8901B</b> Modulation Analyzer	\$14,650
<b>Opt 001</b> RF connectors on rear panel only	+\$240
<b>Opt 002</b> high stability time base	+\$825
<b>HP 8656B</b> Synthesized Signal Generator	\$6,300
<b>Opt 002</b> RF connectors on rear panel only	+\$200
<b>HP 8903B</b> Audio Analyzer	\$6,320
<b>Opt 001</b> RF connectors on rear panel only	+\$105
<b>Opt 010</b> 400 Hz high pass filter	+\$215
<b>Opt 051</b> CCITT weighting filter (for TACS only)	+\$215
<b>Opt 053</b> C-Message weighting filter (for AMPS only)	+\$215
<b>HP 8958A</b> Cellular Radio Interface	\$12,300
<b>HP 6024A</b> Power Supply	\$2,025
<b>HP 11804A</b> Accessory Kit	\$2,785



### Automated Transceiver Test

Hewlett-Packard's transceiver test solutions are flexible combinations of instrumentation and software for automatically testing radio transmitters and receivers. This approach to transceiver test provides comprehensive, expandable solutions for a wide range of applications, allowing you to choose the right combination of hardware and software to fit your needs today and in the future.

An integral part of Hewlett-Packard's transceiver test product line is the wide variety of software application test packages that are available to meet your testing needs. These packages offer a broad spectrum of solutions ranging from basic in-channel measurements to full radio characterization. With test times typically measured in seconds, these packages quickly and accurately measure transceiver performance.

### HP 11805A Transceiver Test Software Exceptional Flexibility and Expandability

The HP 11805A transceiver test software package is a comprehensive solution for automatically testing radio receivers and transmitters. The HP 11805A software package provides quick and easy testing with full softkey operation, concise graphics, and easy-to-read test results.

The software consists of a main executive program and a separate series of measurement test packages. You purchase only the measurement capability you need; you can expand with full compatibility later. This new approach to software development allows the HP 11805A to fit into any testing environment, dependent only on the measurement capability purchased. If you have a specialized application, the software can easily be modified. It is written in BASIC language. The HP 11805A tests multiple channel radios and, for standard FM and AM radios, can encode and decode Continuous Tone Controlled Squelch (CTCSS) and Digital Coded Squelch (DCS) tones automatically. In addition, the test packages allow all tests on all channels, selected prime channels, or selected test/channel combinations.

For cellular radio applications the HP 11805A offers test packages that are fully compatible with the AMPS, TACS and EIA-800 cellular radio test standards. In addition, there are application packages capable of fully testing AM and SSB-SC radios.

Pass/Fail limit testing allows you to quickly verify your radio's performance. Optimized for speed and repeatability, the HP 11805A increases productivity and efficiency. With the optional bar code reader, radio parameters can be entered in seconds and stored on disc for future use. In addition, a Manual Mode allows you to manually control test instrument settings through the computer without leaving

the program. Clear instructions, easy-to-read graphics, and helpful program prompts guide you through every step of the program.

Utility programs are also among the powerful capabilities of the HP 11805A software package. The System Interconnection Verification program is designed to ensure that all instruments are responding to the computer controller. The System Calibration program measures all the path losses from the radio through the interface. These path losses are then accounted for in the measurement test routines, increasing the accuracy and repeatability of the test results.

### HP 11798A Cellular Radio Software

#### NMT Cellular Radio Software

The HP 11798A Cellular Radio Test Software provides the comprehensive RF and signaling tests required for testing cellular mobile radios conforming to the 450 and 900 MHz standards of the Nordic Mobile Telephone (NMT) system. With user-written software, the system is also capable of simulating a mobile station for base station signaling tests.

Tests can be selected and run in any order, giving you complete control of your test routines. These routines include call processing functions such as origination, origination reorder and paging. The results are then displayed in a concise format with Pass/Fail limits, allowing you to quickly verify your radios performance. The HP 11798A is an excellent solution to your NMT cellular radio testing needs.

Additional features of the HP 11798A include a calibration utility capable of measuring and correcting for the insertion and path losses in the system and a special Manual mode which allows you to manually control the test instruments from the computer controller.

#### Ordering Information

HP 11805A Software Application Pac	Price
HP 11805A Software Application Pac	\$0
Opt 001 Operating System Executive	\$1,650
Opt 100 North American FM Tests	+\$525
Opt 101 Extended North American FM Tests	+\$815
Opt 200 European $\phi$ M Tests	+\$525
Opt 201 Extended European $\phi$ M Tests	+\$800
Opt 300 AM Radio Tests	+\$525
Opt 400 SSB-SC Radio Tests	+\$815
Opt 500 AMPS Cellular Radio Tests	+\$815
Opt 510 TACS Cellular Radio Tests	+\$815
Opt 520 EIA-800 Cellular Radio Tests	+\$815
Opt 530 TACS with AMPS Bus Cellular Radio Tests	+\$815
Opt 540 E-TACS Cellular Radio Tests	+\$790
HP 11798A NMT Software Application Pac	\$1,130

HP Model No	HP 11805A											HP 11798A
	Opt 100	Opt 101	Opt 200	Opt 201	Opt 300	Opt 400	Opt 500	Opt 510	Opt 520	Opt 530	Opt 540	
Type of radios Tested	FM	Extended FM	PM	Extended PM	AM	SSB-SC	AMPS w/ AMPS Bus	TACS	EIA-800 AMPS w/o AMPS Bus	TACS w/ AMPS Bus	E-TACS	NMT
Controllers Supported <sup>1</sup>	200 300 Vectra	200 300 Vectra	200 300 Vectra	200 300 Vectra	200 300 Vectra	200 300 Vectra	200 300 Vectra	200 300 Vectra	200 300 Vectra	200 300 Vectra	200 300 Vectra	200 300
Language Supported	BASIC 5.0	BASIC 5.0	BASIC 5.0	BASIC 5.0	BASIC 5.0	BASIC 5.0	BASIC 5.0	BASIC 5.0	BASIC 5.0	BASIC 5.0	BASIC 5.0	BASIC 5.0
Systems Supported	8953A 8955A 8957S	8953A <sup>2</sup> 8955A	8953A 8955A 8957S	8953A <sup>2</sup> 8955A	8953A 8955A	8953A 8955A		8957S	8957S	8957S	8957S	8957S <sup>3</sup>
Measure Squelch	CTCSS DCS	CTCSS DCS	CTCSS DCS	CTCSS DCS								
Generate Squelch	CTCSS DCS	CTCSS DCS	CTCSS DCS	CTCSS DCS								
Number of tests Performed	20	9	17	8	17	16	35	20	19	29	21	21

<sup>1</sup> Only selected configurations are supported

<sup>2</sup> HP 8953A system must include Option 100

<sup>3</sup> HP 11799A is also required

# TRANSCIVER TEST EQUIPMENT

## RF Interfaces

HP 8954A, 8956A, 8958A, 11799A

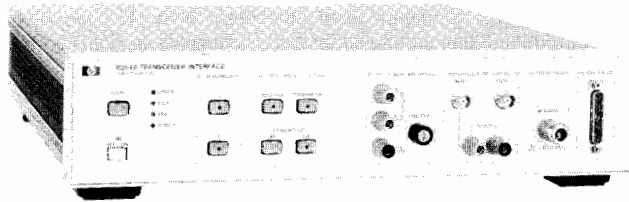

HP 8954A

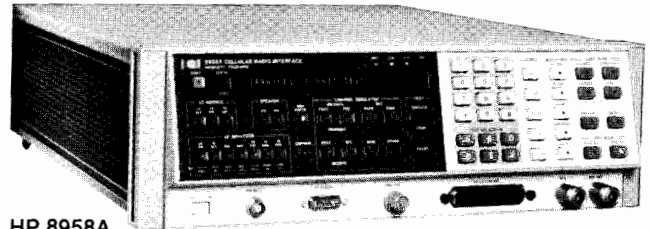

HP 8958A

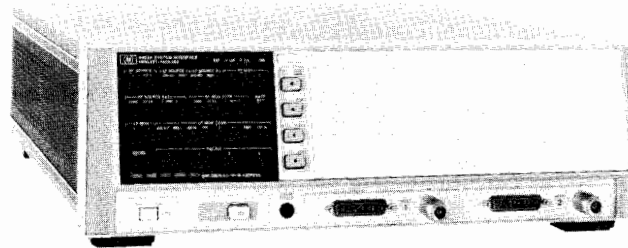

HP 8956A

### HP 8954A Transceiver Interface

The HP 8954A is Hewlett-Packard's lowest priced transceiver test interface. It is fully programmable and uses microwave switches and hardware in all RF paths. Designed for dc to 18 GHz measurements, the HP 8954A Transceiver Interface provides the flexibility needed for most AM, FM and SSB receiver and transmitter testing.

### HP 8954A-H03 Transceiver Interface

The HP 8954A Option H03 Transceiver Interface is a full-duplex version of the standard HP 8954A. The standard RF switching hardware is replaced with a power divider network that is designed for 10 MHz to 1500 MHz use. The HP 8954A Option-H03, when used with the HP 11799A Signaling Unit, is part of the recommended configuration for testing NMT (Nordic Mobile Telephone) cellular radios.

### HP 8956A System Interface

The HP 8956A System Interface, with its multiple paths and connections, provides added flexibility in the designing of systems in the frequency range from dc to 1000 MHz. It has two RF test ports for duplex testing, stimulus/response testing and reduced connect/disconnect times. A built-in, switchable 120 watt 30 dB attenuator can be inserted for transmitter testing and removed for receiver testing, increasing receiver measurement range.

Additional functions of the HP 8956A include current drain and timing measurements.

### HP 8958A Cellular Radio Interface

The HP 8958A Cellular Radio Interface gives your system the capability to fully test a cellular radio. With the flexible Channel Simulator, you can simulate cell-site operation, verify signaling protocol, or perform highly complex and sophisticated tests using an external controller to generate and analyze data content.

### HP 11799A Signaling Unit

For testing cellular radios compatible with the 450 and 900 MHz protocols of the Nordic Mobile Telephone (NMT) system, Hewlett-Packard supplies the HP 11799A Signaling Unit.

When used with the three basic transceiver test instruments and a duplex interface, the HP 11799A simulates a base station and mobile exchange for over-the-air RF and signaling tests of cellular mobile radios.

### Ordering Information

HP 8954A Transceiver Interface  
 HP 8954A-H03 Transceiver Interface  
 HP 8956A System Interface  
 HP 8958A Cellular Radio Interface  
 HP 11799A Signaling Unit

### Price

\$4,425  
 \$7,425  
 \$14,700  
 \$12,300  
 \$14,400

### System Interface Comparison

	HP 8954A	HP 8954A-H03	HP 8956A	HP 8958A
Frequency Range	DC to 18 GHz	10 to 1500 MHz	DC to 1000 MHz	10 to 1500 MHz
Number of RF Ports	4	4	6	6
Number of Audio Ports	2	2	4	2
Number of UUT Ports	1	1	2	1
Duplex Capabilities	NO	YES	YES	YES
Typical Applications	AM, FM, ØM, SSB	AM, FM, ØM, SSB, NMT <sup>1</sup>	AM, FM, ØM, SSB	AMPS, TACS, NMT <sup>1</sup>

<sup>1</sup>Requires the HP 11799A Signaling Unit

# TRANSCIVER TEST EQUIPMENT

## 0.3 GMSK Modulation Measurement Software

HP 11836A

341

- Global measurement of GSM digital cellular radio transmitters
- rms phase error accuracy - greater of 0.1° rms or 5% of reading
- Peak phase error accuracy - < 1.0° peak

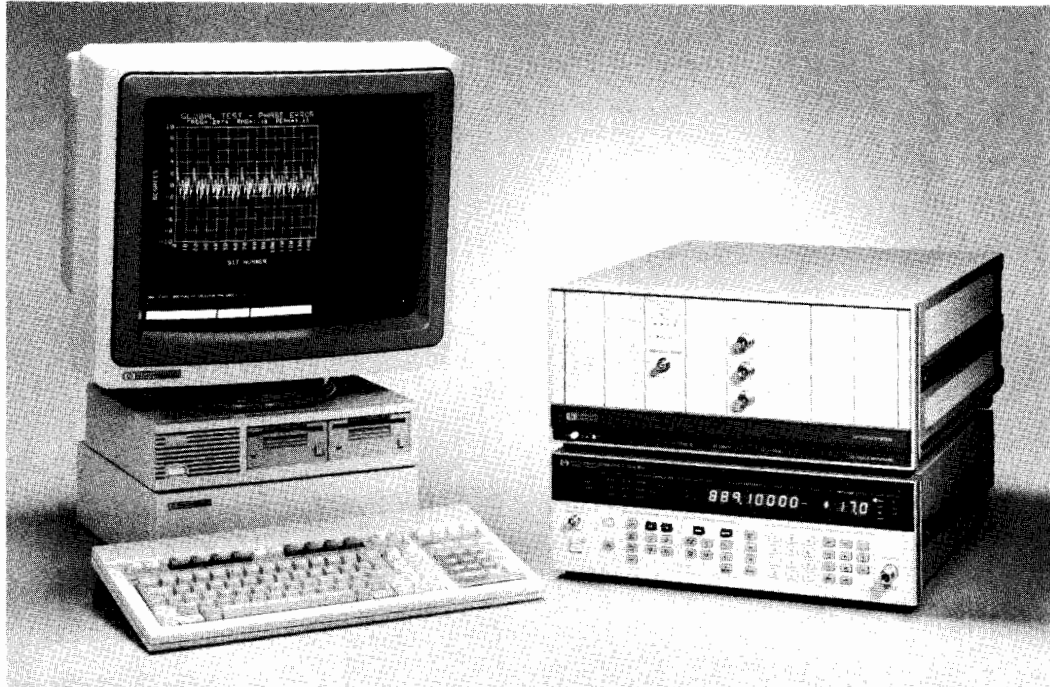

HP 11836A

### HP 11836A 0.3 GMSK Modulation Measurement Software

The HP 11836A software package is an easy-to-use, accurate solution for testing transmitters designed for the Groupe Special Mobile (GSM) Pan-European Digital Cellular Radio System. By digitizing the signal and performing mathematical calculations, it measures transmitter carrier frequency accuracy, modulation phase error (peak and rms), and amplitude envelope, and it recovers the data along with a measuring the spectrum of the signal over a single time slot. This technique is often referred to as the global method.

The software digitally reconstructs the actual transmitted data, and from it, computes the phase trajectory from a theoretically perfect 0.3 Gaussian Minimum Shift Keying modulator. It also uses the recovered data to very precisely regenerate the data clock, to use to synchronize the data stream. By subtracting the actual phase trajectory from the calculated ideal trajectory, the phase error is obtained and frequency error, rms phase error and peak phase error can be determined.

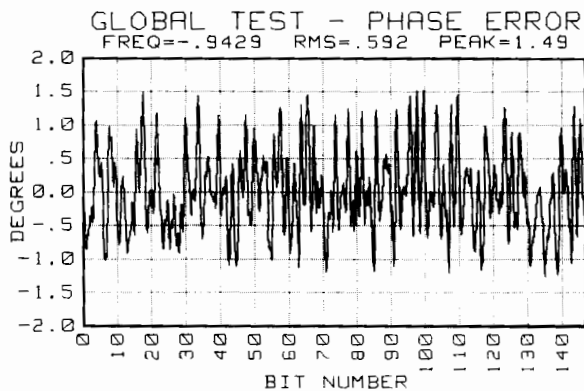

Sample software output

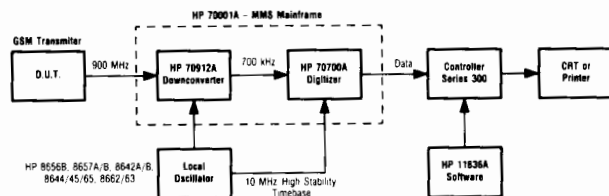

0.3 GMSK Modulation Measurement System Block Diagram (Global Method)

#### Ordering Information

HP 11836A 0.3 GMSK Modulation Measurement Software **Price** \$10,300

#### Associated equipment

##### Required:

HP 70001A System Mainframe \$5,610  
 HP 70700A Digitizer Module \$7,800  
 HP 70912A Downconverter Module \$3,605

##### Local Oscillator (one of the following):

HP 8642A/B, HP 8644A, HP 8645A, HP 8656B, HP 8657A/B, HP 8662A, HP 8663A, or HP 8665A

**Controller:** The software requires BASIC 5.13 on an HP 9000 Series 200/300 or the BASIC Language Processor (HP 82300B) for the HP Vectra Personal Computers. Due to the extensive computations done by the software, the HP 9000 Model 340 or HP 9000 Model 332 (with Opt. 882) is recommended.

**Memory:** At least 2 Mbyte RAM

##### Optional equipment:

**Printers:** HP-IB Printers such as the HP ThinkJet \$495

##### Modular Measurement System Graphics Displays:

HP 70205A Graphics Display \$5,100  
 HP 70206A System Graphics Display \$7,140

# TRANSCEIVER TEST EQUIPMENT

## $\pi/4$ DQPSK Modulation Measurement Software

HP 11847A

- Characterization of North American Digital Cellular Transmitters
- Measurements on I-Q baseband drive signals
- Option 001 for Japanese Digital Cellular

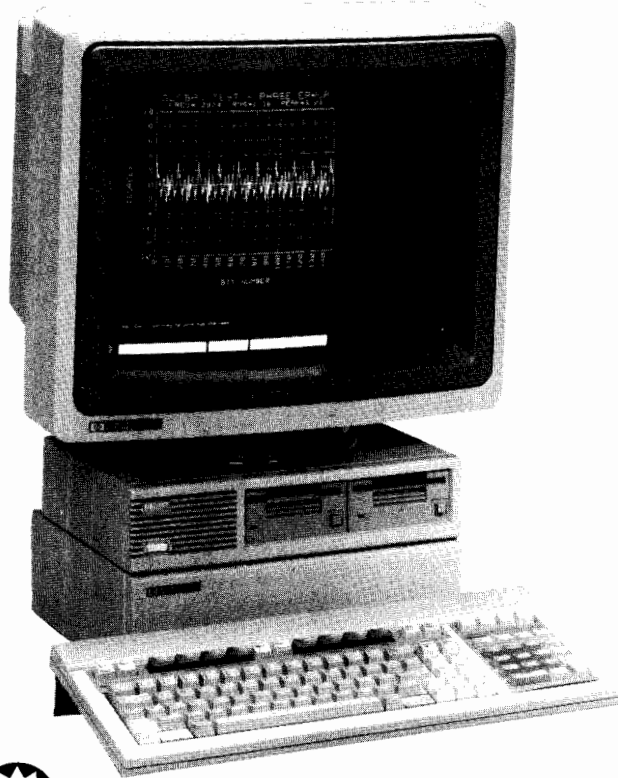

The HP 11847A  $\pi/4$  DQPSK Modulation Measurement Software

### HP 11847A $\pi/4$ DQPSK Modulation Measurement Software

The HP 11847A  $\pi/4$  DQPSK modulation measurement software allows accurate verification of the RF performance of cellular transmitters conforming to TR 45.3 committee recommendations. It builds on the success for the HP 11836A 0.3 GMSK modulation measurement software for the Pan European GSM Digital Cellular system by implementing similar measurements for the North American Digital Cellular System. The software package uses digital signal processing (DSP) techniques to demodulate RF signals, recover the data and measure the modulation accuracy. These patented DSP techniques result in unequalled modulation measurement accuracy and repeatability. The HP 11847A measures: carrier frequency error, modulation phase and amplitude error, and error vector magnitude. In addition, many valuable graphs of the demodulated signal can be viewed. These graphs include I and Q channel EYE diagrams, the I-Q diagram, phase and amplitude graphs, and the error vector magnitude graph. Other supplied measurements include measurements of the TDMA amplitude characteristics and FFT measurements of the error vector magnitude data.

The  $\pi/4$  Differential Quadrature Phase Shift Keying ( $\pi/4$  DQPSK) signal to be measured is downconverted from the 800 MHz band to an IF through the HP 70912A. The signal generator (recommended unit is the HP 8657A synthesized signal generator) supplies the Local oscillator signal to mix down the signal. The IF output of the HP 70912A is sent to the input of the HP 70700A. The digitizer samples the incoming signal and converts it into digital data, which is sent to the Series 300 controller for processing. The HP 11847A then computes the desired measurement parameters.

### Ordering Information

HP 11847A  $\pi/4$  DQPSK modulation measurement software.

Opt 001 Japanese Digital Cellular.

**Price**  
\$10,300

\$0

### Associated Equipment

#### Required:

HP 70001A system mainframe

\$6,750

HP 70700A digitizer module

\$7,980

HP 70912A downconverter module

\$3,605

**Local Oscillator** (one of the following):

HP 8642A/B, HP 8644A, HP 8645A, HP 8656B, HP 8657A/B, HP 8662A, HP 8663A, or HP 8665A

contact HP

**Controller:** The software requires BASIC 5.13 on an HP 9000 Series 300. Due to the extensive computations done by the software, the HP 9000 Model 340 or Model 332 (with Opt. 882) is recommended.

**Memory:** At least 3 Mbyte RAM.

#### Optional:

**Printers:** HP-IB Printers such as the HP ThinkJet

\$495

**Modular Measurement System graphics displays:**

HP 70205A graphics display

\$5,730

HP 70206A system graphics display

\$8,325

# TRANSCEIVER TEST EQUIPMENT

$\pi/4$  DQPSK I-Q Generator

HP 11846A

343

- Provides filtered baseband I-Q outputs
- Designed for North American Digital Cellular
- <2.8% Error Vector Magnitude
- Option 001 for Japanese Digital Cellular

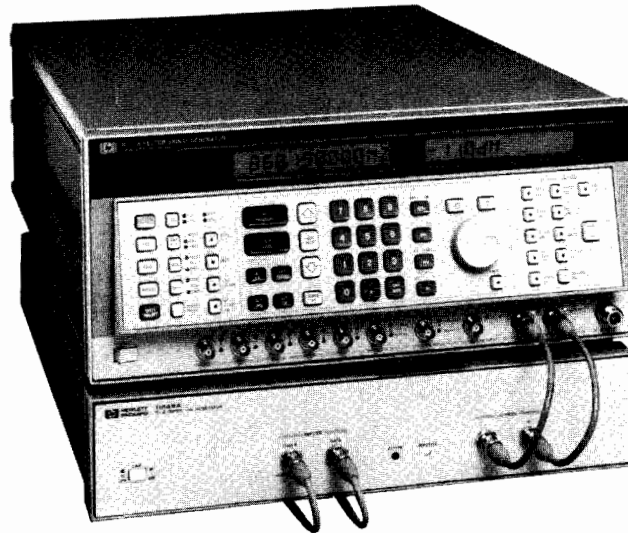

The HP 11846A with HP 8780A

## HP 11846A $\pi/4$ DQPSK I-Q Generator

The HP 11846A  $\pi/4$  DQPSK I-Q Generator is designed to produce the filtered I and Q baseband signals needed to create the modulation format used by the North American Digital Cellular System. When used with an I-Q signal generator such as the HP 8780A vector signal generator, the HP 11846A can provide accurate  $\pi/4$  DQPSK modulated signals for testing these digital cellular receivers.

The  $\pi/4$  Differential Quadrature Phase Shift Keying ( $\pi/4$  DQPSK) modulation chosen for the North American Digital Cellular system uses two data bits to define a symbol with one of four possible I-Q plane locations. Odd symbols are rotated in the I-Q plane by  $\pi/4$  or 45 degrees. In order to generate this modulation, digital data must first be differentially encoded to derive baseband I and Q signals. The I and Q signals must then be filtered to reduce the signal bandwidth to an acceptable level. The required filtering must have a linear phase response and square root raised cosine (root Nyquist) frequency response. Once the I and Q signals have been filtered, they can be applied to the I and Q inputs of a signal generator to create the modulated RF signal.

The HP 11846A provides I and Q baseband signals that fully conform to the requirements for the North American Digital Cellular System as specified by the EIA document IS-54. The HP 11846A requires serial data input and a 48.6 kHz clock signal to generate  $\pi/4$  DQPSK I and Q baseband drive signals. The serial data is internally converted to two-bit parallel form and then differentially encoded in preparation for input to the filter section. The required filtering is digitally implemented to provide excellent accuracy and long-term stability. The error for both the I and Q outputs is less than  $\pm 2.8\%$  from the ideal response as defined by EIA IS-54 (typically less than 1.8%). The I and Q outputs have 50  $\Omega$  impedance and provide peak signals of 0.35 volts (an internal jumper can be set to increase the I-Q output signals to 5 volts).

## HP 11846A Specifications

**I-Q baseband output format:**  $\pi/4$  DQPSK

**Clock input frequency:** 48.6 kHz ( $\pm 1$  kHz)

**Premodulation filter:** Square Root Raised Cosine (Root Nyquist), roll-off factor  $\alpha = 0.35$

**I-Q error vector magnitude:** <2.8% from ideal  $\pi/4$  DQPSK baseband waveforms in EIA document IS-54 (typically 1.8%)

**I-Q output level:** 0.35 volt peak output into a 50  $\Omega$  load (symmetrical about ground and non-adjustable)

**Symbol clock output:** TTL levels, rear panel BNC

## Option 001 Specifications

### Japanese Digital Cellular compatible

**Clock input frequency:** 42 kHz ( $\pm 1$  kHz).

**Premodulation filter:** Square Root Raised Cosine (Root Nyquist), roll-off factor  $\alpha = 0.5$ .

### General

**Operating temperature range:** 15° C to 35° C

**Storage temperature range:** -55° C to 75° C

**Power requirements:** 90 to 264 Hz volts from 48 to 66 Hz; 75 VA maximum

**Weight:** Net 6 kg (13.2 lb); shipping, 11 kg (24.2 lb)

**Size:** 88 H x 425 W x 346 D mm (3.5" x 16.75" x 13.6")

## Ordering Information

HP 11846A  $\pi/4$  DQPSK I-Q Generator.

Opt 001 Japanese Digital Cellular.

## Price

\$5,000

\$0

# NOISE FIGURE METER

## Noise Measurements

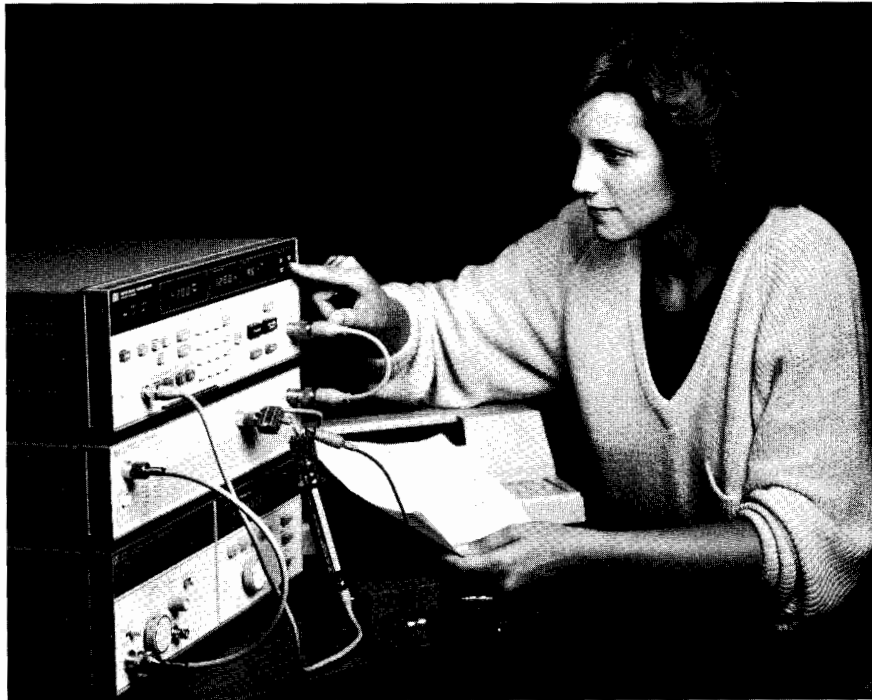

### What is Noise Figure?

Modern receiving systems must often process very weak signals. Noise added by the receiving system components often determines whether or not an input signal can be processed properly. Unlike other ways to measure receiver noise (minimum discernable sensitivity, tangential sensitivity, etc.) noise figure is an objective measure, it does not depend on the judgement of the person measuring. In addition, noise figure is universal; it may be determined for transistors, amplifiers, and mixers as well as entire systems.

Noise figure can be expressed as the ratio of total output noise power (at a source temperature of 290K) compared to the output noise power if there were no noise added by the device under test (DUT).

Noise figure is typically measured by applying two known noise powers to the test device input and measuring the corresponding output powers. Assuming the device is linear, it can then be characterized with respect to total output noise power for all values of input noise power. Noise figure is calculated (ratio of total output noise power versus output noise power assuming no device noise) assuming an input noise power generated from a 290K thermal noise source.

To learn more about noise figure basics and measurement, read HP Application Note 57-1 (see Literature on this page).

### Single- and Double-sideband Noise Figure Measurements

There are both advantages and disadvantages to single- and double-sideband measurements.

Double sideband microwave measurements are easy. The most basic set-up requires only a mixer and local oscillator. However, the resulting noise figure is the average of the test device performance at the two down-converted frequencies. If the device characteristics vary rapidly with fre-

quency, such as transistors or amplifiers with narrow passbands, double-sideband measurement can introduce significant error. In addition, spurious and harmonically-related signals can also render double-sideband measurement data invalid.

Single-sideband measurements eliminate double-sideband problems. Double-sideband problems like image, spurious, and harmonic signals are removed by pre-selecting the desired noise sideband before mixing. Single-sideband measurements, however, require accurately designed filtering systems (like temperature-compensated YIG filters) which are difficult to design and maintain. In spite of its difficulties, single-sideband is the only way to make a standard, down-converted noise figure measurement - its measured value does not depend on the device characteristics.

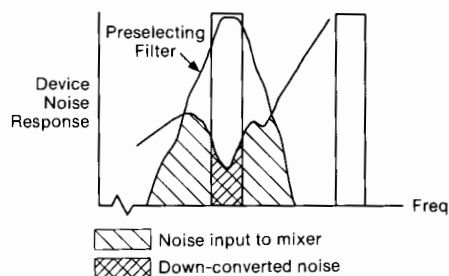
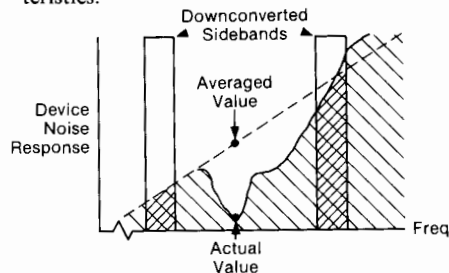

### Noise Figure Measurement Applications

Hewlett-Packard's noise figure measurement equipment is exceptional in applications like these:

**Amplifiers:** 1) Simultaneous noise figure and gain measurement, 2) Results automatically corrected for ENR variations, ambient temperature, and mixer, LO, and IF noise contributions, 3) Real-time, swept, corrected output to oscilloscope for easy tuning (display is digitally stored), 4) Single-test-port calibration and measurement from 10 MHz to 26.5 GHz (with HP 8970 S/U systems).

**Transistors:** All the benefits of measuring amplifiers plus: 1) Easy real-time tuning for best noise figure and gain, 2) real-time tuning to actual transistor  $F_{min}$  without second stage effects, 3) Broadband (10 MHz to 26.5 GHz) single-sideband measurement (with the HP 8970S/U system), 4) Low mismatch effects (the HP 346A features virtually identical impedance for  $T_h$  and  $T_c$ ), 5) Easy to program for automatic systems.

**Receivers and mixers:** 1) Simultaneous measurement of gain (conversion loss) and noise figure, 2) Tunable and swept IF from 10 to 1600 MHz (with the HP 8970B) and 10 MHz to 26.5 GHz (with the HP 8970S/U), 3) No external IF gain needed, 4) Automatic ENR correction, even for broadband sweeps, 5) Effects of LO power, IF power, and IF frequency changes on noise figure are easily observed, 6) Easy to program.

### Literature

**Product Note 8970B/S-2, Applications and Operation of the HP 8970B Noise Figure Meter**, describes the HP 8970B and many of its applications in more detail. It is both an introduction to the HP 8970B and a summary reference manual.

**Product Note 8970B/S-3, Noise Parameter Measurement using the HP 8970B Noise Figure Meter and the ATN NP4 Noise Parameter Test Set**, describes noise parameter measurement on transistors.

**Application Note 57-1, Fundamentals of RF and Microwave Noise Figure Measurements**, explains the theory behind noise figure and its measurement. This note includes an extensive glossary of noise related terms.

**Application Note 57-2, Noise Figure Measurement Accuracy**, discusses considerations for making accurate noise figure measurements and for determining the accuracy of noise figure measurements.

**Product Note 8970B/S-4, Displaying HP 8970B Noise Figure Meter Measurements on the HP 8757 Scalar Network Analyzer**, shows how to use a single display for noise and scalar parameters in production test situations.

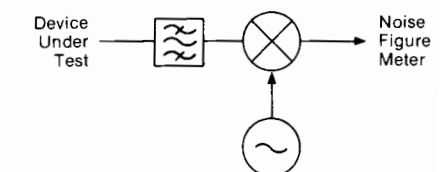

Single sideband noise measurement system.



# NOISE FIGURE METER

## Automatic Noise Figure Meter

HP 8970B

345

- 10 MHz to 1600 MHz.
- Accurate and simple, swept or CW measurements.
- Second stage correction.

- Displays both noise figure and gain.
- Calibrated display on oscilloscope, recorder, or plotter.
- Powerful special function enhancements.

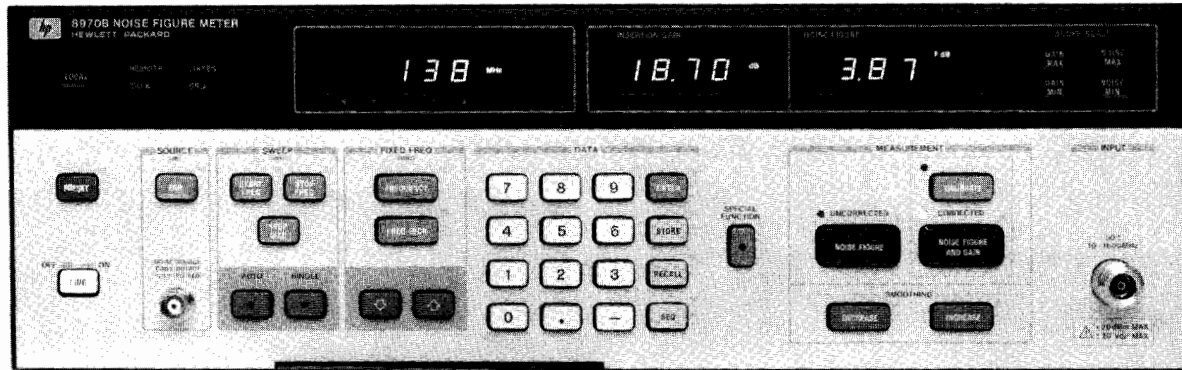

HP 8970B



### HP 8970B Noise Figure Meter

With the HP 8970B Noise Figure Meter, noise figure measurements are easy, accurate, and repeatable. Automatic second stage correction makes accurate noise figure readings possible even for low gain devices. The HP 8970B's dynamic range allows gain measurements of at least 40 dB (higher in some cases) or loss measurements to  $-20$  dB, with no external attenuation or amplification. The HP 8970B can store up to 4 ENR (Excess Noise Ratio) noise source calibration tables. It also properly interpolates ENR values at each measurement frequency.

### Microprocessor and Controller Functions

The HP 8970B takes the mystery out of noise figure measurements. It uses a microprocessor to make the calculations and corrections necessary for truly accurate, convenient, and flexible noise figure measurements. The meter also controls external local oscillators (such as the HP 8671/73 series synthesizers, HP 8340 or HP 8360 series synthesized sweepers, or the HP 8350 sweep oscillator) and the HP 8971B Noise Figure Test Set. This makes accurate, broad-band microwave measurements of amplifiers, mixers, and transistors as simple as RF measurements.

Virtually all of the HP 8970B's front panel keys and functions are accessible over HP-IB, Hewlett Packard's enhanced version of IEEE-488. The meter has an independent System Interface Bus (SIB) to control the HP 8971B and local oscillator. This additional bus frees you from having to write computer code to control an instrument on the SIB (like the local oscillator) when used in an automated set-up. Pass-through capability allows other instrument controllers to send messages through the meter to any other instrument on the SIB.

### Simple Calibration and Second Stage Correction

Noise figure measurement accuracy is enhanced because the meter measures its own noise figure (and that of the rest of the measurement system) at up to 181 points. It stores this information, interpolates where necessary, and corrects for it when displaying the device-under-test noise figure. The HP 8970B also measures the test device gain.

### Display

The HP 8970B's front panel LEDs display frequency, gain, and noise figure. Rear panel BNC connectors allow swept display of noise figure and gain versus frequency on an oscilloscope or x-y recorder. You can also get the noise figure and gain vs. frequency display sent to a digital plotter over the HP 8970B's System Interface Bus. All display modes are easily and accurately scaled to the desired resolution from the meter's front panel. The swept oscilloscope display allows you to optimize your test device in real time for both noise figure

and gain. You can easily change the noise figure display from noise figure to effective noise temperature ( $T_e$ ) or Y factor.

### Front Panel and Special Functions

The HP 8970B front panel keys control the number entry, calibration, and measurement functions. STORE, RECALL, and SEQ keys allow up to 9 front panel settings to be stored and sequenced automatically or manually to save set-up time. Smoothing INCREASE and DECREASE keys are used to average up to 512 readings before display. This increases accuracy and eliminates display flicker.

For those who need greater measurement power than that provided by the HP 8970B's simple front panel, there are more than 200 special functions selected by pressing a numerical code and the special function key. Two examples are hot-cold measurements and automatic compensation for losses at the input of the test device. One of the special functions is a catalog that quickly shows you the current special functions being used. Three pull-out cards serve as a mini-reference manual for the instrument. They include most of the special functions, the HP-IB formats and codes, error messages, and typical measurement set-ups.

### HP 8970B Partial Specifications

(See technical data sheet for complete specifications)

**Noise figure (gain) measurement range:** 0 to 30 dB ( $-20$  to at least 40 dB).

**Noise figure (gain) instrumentation uncertainty:**  $\pm 0.1$  dB for 0 to 55° C ( $\pm 1.5$  dB).

**Noise figure resolution:** 0.01 dB (0.001 dB over HP-IB).

**Gain resolution:** 0.01 dB (0.001 dB over HP-IB).

**Frequency range:** tunable from 10 to 1600 MHz.

**Tuning accuracy (from 10 to 40° C):**  $\pm (1\text{MHz} + 1\% \text{ of frequency})$ , 6 MHz maximum.

**Frequency resolution:** 1 MHz.

**Noise figure (for input power levels below  $-60$  dBm):**  $< 7$  dB + 0.003 dB/MHz.

**Maximum operating input power:**  $-10$  dBm.

**Maximum net external gain:**  $> 65$  dB between noise source and HP 8970B RF input.

**Noise source drive:**  $28.0 \pm 0.1$  volt.

**Operating temperature:** 0° C to 55° C.

**Storage temperature:**  $-55^\circ$  to 75° C.

**Power:** 100, 120, 220, or 240 V (+5%,  $-10\%$ ); 48–66 Hz; 150 VA maximum.

**Dimensions:** 143 H x 425 W x 476 mm D (5.68" x 16.75" x 18.38").

**Weight:** Net, 15.5 kg (34 lb). Shipping, 18.5 kg (40 lb).

# NOISE FIGURE METER

## Noise Figure Measurement System

### HP 8970S/U, 8971C

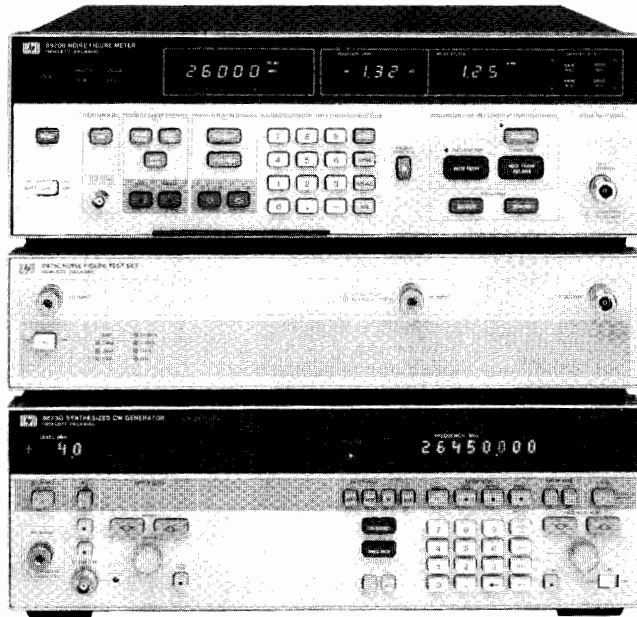

HP 8970S/U  
DESIGNED FOR  
**HP-IB**  
SYSTEMS

### HP 8970S/U Microwave Noise Figure Measurement Systems

Until now, there was no standardized way to make microwave noise figure measurement so users had to design and support their own microwave systems. Measurements crossing from RF to microwave were difficult because they required multiple system configurations.

Hewlett Packard's answer to these problems is the HP 8970S and HP 8970U noise figure measurement systems. Each system consists of the HP 8970B Noise Figure Meter, the new HP 8971C Noise Figure Test Set, and a synthesized local oscillator. (The recommended LOs for the HP 8970S are listed in the HP 8970S Partial Specifications; the HP 8970U uses the HP 8673G Synthesized CW Generator as its local oscillator.)

The HP 8970S/U system eliminates the tedious job of designing the measurement system and selecting components. The HP 8970B acts as the controller, so all system operation is transparent to the user. To insure specified performance, the HP 8970S/U systems are given specifications just like an RF noise figure meter (i.e HP 8970B).

#### HP 8970S/U Partial Specifications

(See HP 8970S technical data sheet for complete specifications)

**Frequency range:** 10 MHz to 26.5 GHz.

**Noise figure measurement range:** 0 to 30 dB.

**Noise figure instrumentation uncertainty:** (for a 14 to 16 dB ENR noise source in a 10 to 40°C environment and for device under test noise figure plus gain greater than 10dB).

10 MHz to 18 GHz:  $\pm 0.2$  dB (Plus typical drift of  $\pm 0.015$  dB/°C)

18 to 26.5 GHz:  $\pm 0.4$  dB (Plus typical drift of  $\pm 0.08$  dB/°C)

**Gain instrumentation uncertainty:**  $\pm 0.28$  dB (Plus typical drift of  $\pm 0.05$  dB/°C, 10 MHz to 18 GHz  
 $\pm 0.07$  dB/°C, 18 to 26.5 GHz)

**Noise figure (max):** 10 to 30 MHz: 18 dB

30 to 100 MHz: 13 dB

0.1 to 12 GHz: 10 dB

12 to 18 GHz: 11.5 dB

18 to 26.5 GHz: 14 dB

**Input SWR:** 10 MHz to 18 GHz: 2.25

18 to 26.5 GHz: 2.7

**Recommended local oscillators:** HP 8671B, 8672A, 8673B/C/E/G, 8340B, 8341B, 83620A, 83622A, 83640A and 83642A.

- 10 MHz to 26.5 GHz
- Fully specified system
- Removes double-sideband inaccuracies
- As easy to operate as the HP 8970A or B

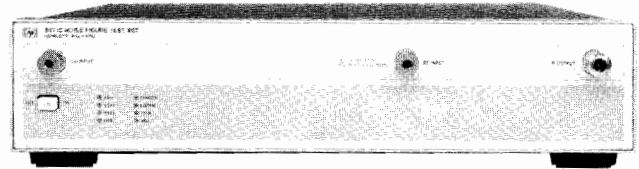

HP 8971C  
DESIGNED FOR  
**HP-IB**  
SYSTEMS

### HP 8971C Noise Figure Test Set

The HP 8971C Noise Figure Test Set brings the simplicity of double sideband measurements and the accuracy of single sideband measurements together in one package. Careful design and high performance components, including a stable YIG filter, allow broadband single-sideband measurements from 10 MHz to 26.5 GHz with a single calibration and sweep. A low noise preamplifier built into the Noise Figure Test Set lowers the second stage noise figure thereby reducing a major source of measurement uncertainty.

Measurement modes in the HP 8970B allow for double down conversion using the HP 8971C as the second down-converter. These modes can be used for millimeter-wave measurements of amplifiers and transistors and measurements of receivers and mixers with IFs above 1.6 GHz.

#### HP 8971C Partial Specifications

(See HP 8970S technical data sheet for complete specifications)

**Frequency range:** 10 MHz to 26.5 GHz.

**Input SWR:** 10 MHz to 18 GHz: 2.25

18 to 26.5 GHz: 2.7

**Image and odd-harmonic rejection:** 20 dB.

#### Accessories supplied

1 LO-to-HP 8971B cable - SMA(f), 300 mm

1 HP 8971B-to-HP 8970B cable - N(m), 190 mm

1 N(m)-to-SMA(m) adapter

2 HP-IB cables - .5 m

# NOISE FIGURE METER

Noise Sources

Models HP 346 A/B/C, R/Q347B

347



HP 36A, HP346B, HP 346C

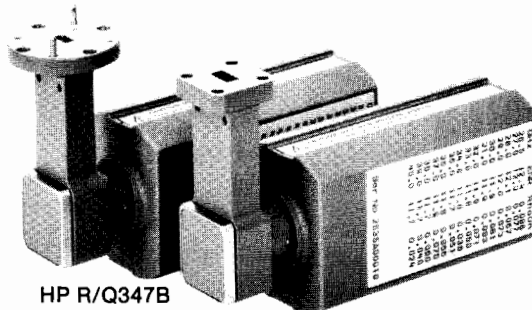

HP R/Q347B

## HP 346A/B/C Broadband Noise Sources

The ideal companion to the HP's noise figure meter and systems is the HP 346 family of noise sources. Since they are broadband (10MHz to either 18 or 26.5 GHz), they eliminate the necessity for several sources at different frequency bands. Each source has individually calibrated ENR values at specific frequencies. The calibration is printed on its label (see illustration) for easy loading into the HP 8970B. The low SWR of each noise source reduces a major source of measurement uncertainty - re-reflections of test signals. In addition, the variety of connectors available reduces the need for degrading accuracy with connector adapters.

The HP 346 family of noise sources are designed for a broad range of measurement applications. The HP 346C covers the broadest frequency range, 10 MHz to 26.5 GHz. The HP 346B's high ENR, low SWR, and variety of connectors make it a general purpose noise source. The HP 346A is designed especially for accurate characterization of input-impedance-sensitive devices (like GaAsFETs and many UHF amplifiers). Its very small change in reflection coefficient (<0.01) from ON to OFF minimizes errors when measuring noise figure and gain as a function of input impedance.

FREQ GHz	ENR dB
0.01	15.18
0.10	15.49
1.0	15.26
2.0	15.17
3.0	14.93
4.0	14.86
5.0	14.91
6.0	14.83
7.0	14.90
8.0	15.05
9.0	15.25
10.0	15.39
11.0	15.43
12.0	15.50
13.0	15.41
14.0	14.93
15.0	15.51
16.0	15.55
17.0	15.62
18.0	15.66

SERIAL NO.  
2037A00428

Example label of HP 346B Noise Source

## HP 346 A/B/C Partial Specifications

(See technical data sheet for complete specifications.)

**Frequency range:** 10 MHz to 18 GHz for HP 346A/B; 10 MHz to 26.5 GHz for HP 346C.

**Excess noise ratio (ENR) limits:** HP 346A: 5 to 7 dB; HP 346B: 14 to 16 dB; HP 346C: 12 to 16 dB (10 MHz to 12 GHz) and 14 to 17 dB (12.0 to 26.5 GHz).

**Maximum SWR (reflection coefficient) on and off:**

**HP 346A/B:** 10 to 30 MHz — 1.3 (0.13); 30 to 5000 MHz — 1.15 (0.07); 5 to 18 GHz — 1.25 (0.11).

**HP 346C:** 10 MHz to 18 GHz — 1.25 (0.11); 18 to 26.5 GHz — 1.35 (0.15).

**Power required:** 28 ± 1 Vdc.

**Dimensions:** 140 H x 21 W x 30 mm D (5.5" x 0.8 x 1.2").

**Weight:** net, 0.108 kg (3.5 oz). Shipping, 0.5 kg (1 lb).

**Standard connector:** APC - 3.5(m)

## HP R & Q347B Solid-state Noise Sources

The performance and reliability you have come to expect from Hewlett-Packard RF and microwave solid-state noise sources, is now extended to millimeter-wave frequencies with the HP R347B (26.5 to 40 GHz) and HP Q347B (33 to 50 GHz) noise sources. A new GaAs avalanche diode specifically designed for high noise output and long term reliability was developed for the HP R/Q347B Noise Sources. This results in excellent ENR stability over time. In turn, this insures long recalibration cycles and very accurate noise figure measurements.

## HP 346C Option K01 Broadband Noise Source

This new coaxial noise source features coverage from 1 to 50 GHz with the 2.4mm coaxial connector. ENR is nominally 20 dB at 1 GHz and 7dB at 50 GHz. Contact HP for technical specifications.

## HP R & Q347B Noise Sources

(See technical data sheet for complete specifications)

**Frequency Range:** R347B - 26.5 to 40 GHz

Q347B - 33 to 50 GHz

## Excess Noise Ratio (ENR) Range:

HP R347B: 10 to 13 dB

HP Q347B: 10 to 13 dB (33 to 42 GHz)

6 to 12.5 dB (42 to 50 GHz)

## Max. SWR (reflection coefficient):

HP R347B: <1.42 (.17)

HP Q347B: <1.57 (.22)

## Supplemental Characteristics

**ENR Variation with temperature:** <.009 dB/C

**ENR Variation with time:**

R 347B: 0.15 dB typ. (over 2000 hrs.)

Q 347B: 0.15 dB typ. (over 2000 hrs.)

## Ordering Information

	Price
HP 8970B Noise Figure Meter	\$11,300.00
Opt H18 Increases upper frequency from 1600 to 1800 MHz	+ \$350.00
Opt 907 Front panel handle kit	+ \$55.00
Opt 908 Rack mounting flange kit	+ \$32.50
Opt 909 Both options 907 and 908	+ \$80.00
Opt 700 External mate translator	+ \$7,055.00
HP 8971C Noise Figure Test Set	\$20,500.00
Opt 001 Add L.O. Power amplifier	+ \$4,500.00
Opt 002 Delete RF preamplifier	- \$3,500.00
HP 8970S Noise Figure Measurement System	See HP8970S

Ordering Guide

HP 8970U Noise Figure Measurement System (10 MHz to 26.5 GHz)	\$65,300.00
HP 346A Noise Source	\$1,650.00
HP 346B Noise Source	\$1,550.00
HP 346C Noise Source	\$2,100.00
HP 346 Opt. K01 Noise Source	\$3,600.00
Opt 001 (HP 346A/B only): Type N (m) connector	\$0
Opt 002 (HP 346A/B only): APC-7 connector	+ \$25.00
Opt 004 (HP 346A/B only): Type N (f) connector	\$0
HP R347B Noise Source	\$2,350.00
HP Q347B Noise Source	\$2,950.00

☎ For same-day shipment, call HP DIRECT at 800-538-8787

# MICROWAVE TEST ACCESSORIES

## Microwave Measurements and Accessories

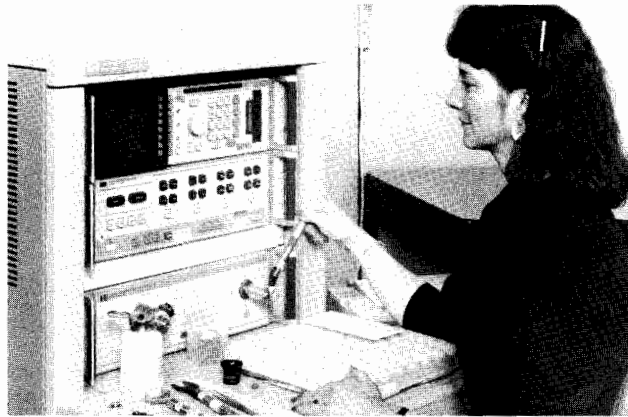

### The Key to Better Measurements

Your test area is a tough environment. Large test volumes put great stress on the measurement components. A worn and non-repeatable adapter significantly degrades system directivity. A lossy cable decreases the dynamic range of a measurement. A non-repeatable switch or step attenuator introduces random insertion errors. For these reasons, HP components and accessories are designed to help ensure long life and repeatability under very demanding conditions.

When you use these products, you take advantage of Hewlett-Packard's experience. Microwave testing is our business, and HP components must meet standards to ensure that our own instruments meet our stringent specifications and reliability goals.



### Technology For Better Measurements

Hewlett-Packard believes that technology creates the performance, quality, and cost that is necessary for a competitive edge now and in the future. This means using precision machining and processes that meet exceptionally tight tolerances in order to allow for the design and manufacture of a 50 GHz 2.4mm coaxial connector that mates with a 65 GHz 1.85mm connector. Also, this means using HP plating and chemical milling facilities to produce connector mating surfaces that have exceptional electrical performance at mm-wave frequencies and that are environmentally rugged for extended life.

HP's solid state technology permits us to build the components and accessories such as Planar Doped Barrier (PDB) diodes and Monolithic Microwave Integrated Circuits (MMICs). PDB diodes are the key to a new family of detectors that provide excellent flatness and sensitivity to 50 GHz in coax, and to higher frequencies in waveguide. MMICs are the heart of new amplifier and probe products that increasingly find their way into the component building blocks you will need to design even more sophisticated test systems.

### Confidence in Component Performance

You can depend on our specifications because our components are not merely sampled; every component is 100% tested, usually on automatic test systems. We use the latest test equipment and techniques,

and test data is stored and tracked with statistical quality control techniques to ensure that we continually improve the products we deliver to you. On many products, you can order actual test data to further reduce measurement uncertainties.

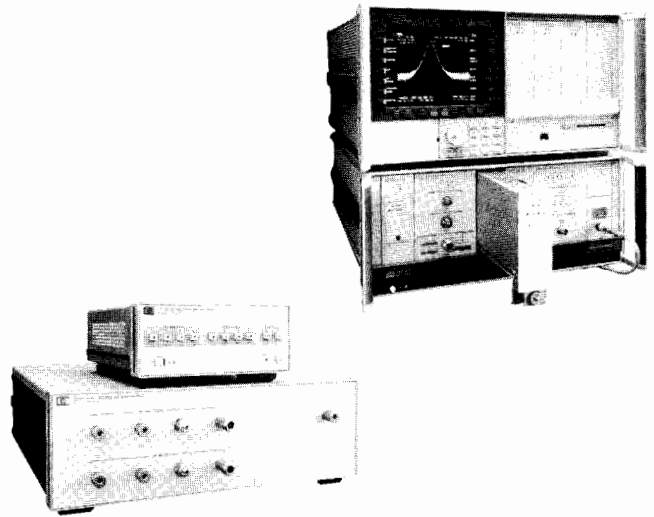

### Hewlett-Packard as Your Partner

Hewlett-Packard will help integrate your measurement systems. For instance, we will integrate an entire series of coaxial switches to create custom automatic test system (ATS or ATE) switch matrixes for your specific requirements. And we will also characterize and document the performance of the switch matrix. For a higher level of system integration, we will help integrate the entire measurement system — switch matrixes, instruments, and controlling computers.

Hewlett-Packard wants to work with you to optimize your test systems. We encourage you to call us with your special requirements when existing products might not meet your exact needs.

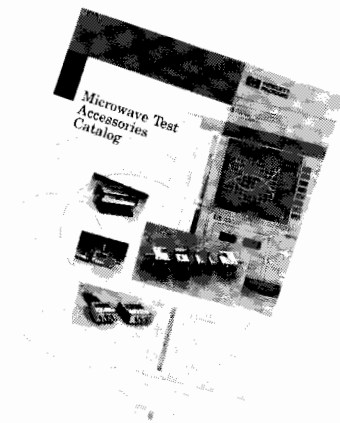

### Microwave Test Accessories Catalog

Configuring a microwave measurement system for the device you are testing requires many precision accessories. We know that low reflection adapters, high directivity couplers and bridges, repeatable switches, and rugged cables all have as great an impact on measurement accuracy as the measuring instruments themselves.

The HP Microwave Test Accessories catalog is designed to help you find these precision accessories. It offers a broad selection of accessories in coax to 50 GHz, waveguide to 110 GHz, and high impedance probes to 3 GHz. The catalog is HP literature number 5952-2843.

# MICROWAVE TEST ACCESSORIES

Transmission Reflection Test Sets, Power Splitters, Power Dividers

HP 8721A, 85044A/B, 11850C/D, 11667A/B/C, 11636A/B

349



HP 85044A

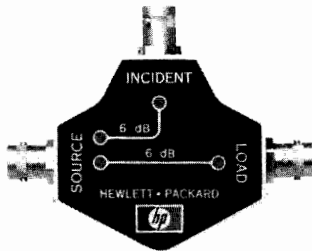

HP 8721A

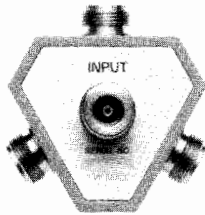

HP 11850C

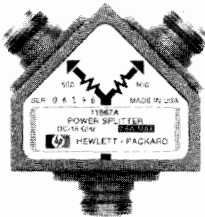

HP 11667A



HP 11636A

## Description

Accurate broadband measurements of transmission and reflection parameters are highly dependent on the device used to separate signals for the measurement. Some devices separate the reflected and transmitted signals and some split power for ratio and comparison measurements.

### HP 8721A Directional Bridge

#### HP 8721A Option 008 75 Ohm Version

**Frequency range:** 0.1 - 110 MHz.

**Directivity:** >40 dB, 1 - 110 MHz, typically >30 dB, 0.1 - 1 MHz.

**Load port match:** >30 dB (VSWR <1.07).

**Transmission arm:** Nominal loss, 6 dB. Frequency response, <0.2 dB.

**Coupling arm:** Nominal coupling, 6 dB. Frequency response, <0.6 dB.

**Maximum input power:** +20 dBm.

**Weight:** net, 0.55 kg (0.25 lb); shipping, 1.1 kg (0.5 lb).

**Size:** 59 H x 39 W x 123 mm D (1.5 x 1 x 3.13 in.).

### HP 85044A 50 Ohm Transmission Reflection Test Set

#### HP 85044B 75 Ohm Transmission Reflection Test Set

The HP 85044 contains a power splitter and directional bridge that permits simultaneous transmission and reflection measurements with over 30 dB directivity from 300 kHz to 3.0 GHz. Detailed specifications on the HP 85044A and HP 85044B appear on page 241.

### HP 11850C 50 Ohm Power Splitter

#### HP 11850D 75 Ohm Power Splitter

These three-way power splitters are designed for ratio measurements from dc to 3.0 GHz (11850C) or 2 GHz (11850D). One output port provides the reference and the other two output ports can be used for independent transmission measurements. They provide 0.25 dB tracking and >20 dB output match. Detailed specifications are on page 243.

### HP 11667A Power Splitter (Type N)

#### HP 11667B Power Splitter (3.5 mm)

#### HP 11667C Power Splitter (2.4 mm)

These two-way, two-resistor splitters provide good input and output source match in ratio measurement and source leveling applications. The HP 11667A operates from dc to 18 GHz with output match >17 dB and tracking <0.25 dB. The HP 11667B operates from dc to 26.5 GHz and has output source match >18 dB and tracking <0.4 dB. The HP 11667C operates from dc to 50 GHz and has an output source match >12 dB and tracking <0.4 dB. Detailed specifications are on page 225.

### HP 11636A/B Power Dividers/Combiners

The HP 11636A/B are two-way, three-resistor power dividers for non-ratio measurements. They can also be used as power combiners for combining two independent signals. They are ideal for fault location measurements with HP 8757S and HP 85016A software.

**Frequency range:** HP 11636A: dc to 18 GHz.

HP 11636B: dc to 26.5 GHz.

**Impedance:** 50 ohms nominal.

**Insertion loss:** 6 dB nominal.

	DC-10 GHz	DC-18 GHz	DC-26.5 GHz
<b>Input SWR</b>			
HP 11636A	<1.25	<1.35	
HP 11636B	<1.22	<1.29	<1.29
<b>Output SWR</b> (non-ratio measurements)			
HP 11636A	<1.25	<1.35	
HP 11636B	<1.22	<1.29	<1.29
<b>Output Tracking</b> (between output arms)			
HP 11636A	<0.4 dB	<0.5 dB	
HP 11636B	<0.25 dB	<0.25 dB	<0.5 dB
<b>Typical Phase Tracking</b> (between output arms)			
HP 11636A	2°	2°	
HP 11636B	2°	2.5°	3°

### Maximum Input Power

HP 11636A +30 dBm

HP 11636B +27 dBm

### Connectors

HP 11636A: Type N male input port, female output ports.

HP 11636B: APC-3.5 female on all ports.

### Dimensions

HP 11636A: 42 H x 45 W x 18 mm D (1.64 x 1.75 x 0.69 in.)

HP 11636B: 40 H x 47 W x 10 mm D (1.6 x 1.9 x 0.4 in.)

### Weight

HP 11636A: net, 0.14 kg (0.31 lb); shipping, 0.45 kg (1 lb)

HP 11636B: net, 0.06 kg (0.13 lb); shipping, 0.14 kg (0.3 lb)

### Ordering Information

HP 8721 Directional Bridge

Opt 008 75 Ohm Version

HP 85044A 50 Ohm Transmission Reflection Test Set

HP 85044B 75 Ohm Transmission Reflection Test Set

HP 11850C 50 Ohm Power Splitter

HP 11850D 75 Ohm Power Splitter

HP 11667A Power Splitter (DC - 18GHz)

Opt 001 Type N Male Input, Type N Female

Outputs

Opt 002 Type N Female Input, APC-7

On Outputs

HP 11667B Power Splitter (DC - 26.5 GHz)

HP 11667C Power Splitter (DC-50 GHz)

HP 11636A Power Divider (DC - 18 GHz)

HP 11636B Power Divider (DC - 26.5 GHz)

☎ For same-day shipment, call HP DIRECT at 800-538-8787

### Price

\$395

+ \$50

\$3,200

\$3,700

\$930

\$1,495

\$930

\$0

+ \$75

\$995

\$1,500

\$550

\$995



# MICROWAVE TEST ACCESSORIES

Coaxial Fixed Attenuators, Gage Kits, Blocking Capacitor, Air Line Extensions, Harmonic Mixers

HP 8490 Series, 11581/2/3, 11752 Series, 11742A, 11566/7A, 11970 Series



HP 8493C



HP 11742A



HP 11566A

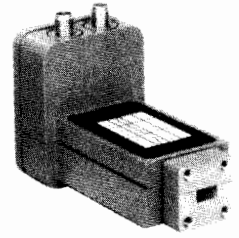

HP 11970 Series

## HP 8490D, 8491A/B, 8492A, 8493A/B/C Fixed Attenuators

Hewlett-Packard coaxial fixed attenuators provide precision attenuation, flat frequency response, low SWR over broad frequency ranges (dc-50.0 GHz) at low prices. Attenuators are available in nominal attenuations of 3-dB and 6-dB, also 10-dB increments from 10 dB to 60 dB. These attenuators are swept-frequency tested to ensure meeting specifications at all frequencies. Calibration points are provided on a nameplate chart attached to each unit.

## HP 11581A, 11582A, 11583A/C Attenuator Sets

A set of four Hewlett-Packard attenuators—3, 6, 10 and 20 dB—are furnished in a handsome walnut accessory case. The HP 11581A set consists of HP 8491A Attenuators; the HP 11582A set, HP 8491B Attenuators; the HP 11583A set, HP 8492A Attenuators; and the HP 11583C set, HP 8493C Attenuators. The set includes calibration reports certified traceable to the National Institute of Standards and Technology, containing both the attenuation and the reflection coefficients for each attenuator at the frequencies indicated under "Option 890" calibration data on the next page. Thus it is not required to specify Option 890.

These sets are ideal for calibration labs or where precise knowledge of attenuation and SWR is desired.

## HP 8498A High Power Attenuator

The HP 8498A Option 030 is designed to meet the needs of high power attenuation applications in the RF and microwave frequency range. It is specified from dc to 18 GHz at 25 watts average, 500 watts peak, from dc to 5.8 GHz and 125 watts peak from 5.8 to 18 GHz. Available only in a 30 dB model (option 030), the unit offers low SWR (<1.30 at 18 GHz) and good accuracy ( $\pm 1$  dB at 18 GHz). The unit also features 'human engineered' cooling fins that prevent operator burns even under continuous maximum input power conditions.

## Option 890 Calibration Data

Extensive calibration data is available on HP attenuators at low cost. When option 890 is specified for the fixed attenuators or microwave step attenuators, standardized calibration data in frequency steps no larger than 500 MHz is provided over the frequency range of the units. This data is generated from measurements made on an HP 8510 Automatic Network Analyzer and features excellent accuracy (traceable to NIST) and low cost. Data is given for attenuation and the SWR (reflection coefficient for the HP 8493C) of each port and is provided in a protective plastic envelope.

Calibration data has important uses in applications such as RF substitution measurements and test system verification. Using the actual calibration data rather than data sheet specifications allows the attenuation uncertainty to be reduced 60% or more. Also, the calculated mismatch uncertainty for a test system is lower if the actual SWR data for the attenuators is used.

## HP 11742A Blocking Capacitor

The HP 11742A is a high performance outside blocking capacitor. It features broadband performance, low SWR (1.2 from .01 to 26.5 GHz) and low insertion loss (.6dB from .01 to 26.5 GHz). The HP 11742A comes with 3.5 mm connectors. It is ideal for use with high frequency oscilloscopes and in bias circuits for the attenuation of low frequencies and blocking D.C. voltages up to 50V.

## HP 11752C/D/E Coaxial Connector Gage Kits

With SMA connectors or with the newer 2.4, 2.92, or 3.5mm connectors, pin depth and dielectric control are critical to ensure repeatable measurements and to prevent connector damage. The HP 11752C SMA Connector Gage Kit is designed to measure pin depth or setback and dielectric protrusion. Each gage kit is supplied to make both measurements, on either male (option 001) or female (option 002) connectors. All gages feature rugged mechanical indicators graduated in 0.0001-inch increments for accurate adjustment of center conductor pin depth and dielectric protrusion.

The HP 11752D is used for measuring center conductor pin depth on 3.5mm connectors and the HP 11752E measures 2.92 and 2.4mm connectors. Each of these kits contain a male and female gage plus their respective gage set masters. Each kit is supplied with a handsome walnut case and a comprehensive user's manual.

## HP 11566A, 11567A Air Line Extension

**Impedance:** 50 ohms.

**Frequency:** dc-18 GHz.

**Reflection coefficient:**  $0.018 + (0.001 \times \text{frequency in GHz})$ .

**Connector:** APC-7.

**Length:** 11566A, 10.21 cm (4 in.); 11567A, 20.21 cm (8 in.)

**Shipping weight:** 0.45 kg (1 lb).

## Ordering Information

HP 11752C SMA Connector Gage Kit

Opt 001 Male Pin Depth & Dielectric

Opt 002 Female Pin Depth & Dielectric

HP 11752D 3.5mm Connector Gage Kit

HP 11752E 2.92 & 2.4 mm Connector Gage Kit

HP 11742A Blocking Capacitor

HP 11566A Air Line Extension

HP 11567A Air Line Extension

## Price

\$1,200

\$1,200

\$1,300

\$1,400

\$170

\$365

\$400

## HP 11970 Series Harmonic Mixers

Although designed for operation with HP spectrum analyzers, these broadband mixers also serve a wide variety of general-purpose uses for the frequency bands from 18 to 110 GHz. Such uses include down-conversion for noise figure and network analysis measurements.

As down-conversion mixers for test receivers, the HP 11970s offer flat response, low SWR, and low conversion loss without requiring bias. These mixers can also serve as harmonic generators with input signals from 2 to 6.1 GHz. Outputs are at the band specified, and each mixer is individually calibrated for conversion loss over its complete band.

## HP 11970 Series Specifications

HP Models	Frequency Range (GHz)	Frequency Response (dB)	Waveguide and Equivalent Flange	Price
11970K	18 - 26.5	$\pm 1.9$ $\pm 2.1$	WR-42 UG-595/U	\$1750
11970A	26.5 - 40	$\pm 1.9$ $\pm 2.1$	WR-28 UG-599/U	\$1800
11970Q	33 - 50	$\pm 1.9$ $\pm 2/3$	WR-22 UG-383/U	\$1950
11970U	40 - 60	$\pm 1.9$ $\pm 2.3$	WR-19 UG-383/U (mod)	\$2200
11970V	50 - 75	$\pm 2.1$ $\pm 2.5$	WR-15 UG-385/U	\$2650
11970W	75 - 110	$\pm 3.0$	WR-10 UG-385/U (mod)	\$3000

☎ For same-day shipment, call HP DIRECT At 800-538-8787.



# MICROWAVE TEST ACCESSORIES

## Coaxial Step Attenuators

HP 355 Series, 8494/5/6/7 Series, 11716 Series, 33320 Series

- Excellent repeatability
- Manual and programmable
- Calibration data available
- Five million cycles per section reliability



HP 8495D

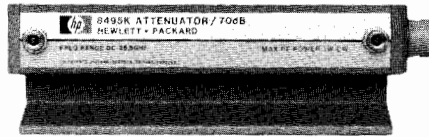

HP 8495K

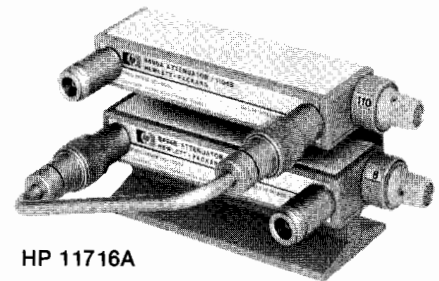

HP 11716A



### DC-1000 MHz Programmable and Manual Step Attenuators. HP 355C/D/E/F

- Precision attenuation from DC to 1000 MHz
- 355C/E provide 0-12 dB in 1 dB steps
- 355D/F provide 0-120 dB in 10 dB steps
- All standard models use standard BNC RF connector
- Programmable models (E/F) use 7-pin connector

### DC-26.5 GHz Programmable and Manual Step Attenuators

- HP 8494A/B/G/H (0-11 dB, 1 dB steps)
- HP 8495A/B/D/G/H/K (0-70 dB, 10 dB steps)
- HP 8496A/B/G/H (0-110 dB, 10 dB steps)
- HP 8497K (0-90 dB, 10 dB steps)

Hewlett Packard attenuators offer exceptional repeatability and reliability in a wide range of attenuation, frequency, and connector options.

- SMA (f), Type N (f), APC-7 mm (f), and 3.5 mm RF connectors
- DC-4 GHz, DC-18 GHz, and DC-26.5 GHz models
- Permanent magnet latching design and automatic DC current interrupts simplify programmable model drive circuit design

The convenient matrix on the facing page shows the complete model/option lineup.

Each attenuator contains three or four cascaded attenuator sections; edge-line contacts insert and remove attenuator sections as needed. Precision gold plated leaf springs ensure long life (over 5 million cycles) and very high attenuator repeatability (typically 0.01 dB). Programmable models (G, H, K suffixes) feature fast-switching solenoids; attenuation programming is done through a 12-pin connector.

To improve measurement accuracy in manual and automated test systems, NIST traceable calibration data (SWR and attenuation) is available as Option 890. Generated on an HP 8510 network analyzer, this option offers swept data for each attenuator step in 250 MHz steps from 1500 MHz to 26.5 GHz (upper frequency varies by model).

To simplify connecting programmable attenuators to the drive circuit, each unit is supplied with a five-foot cable assembly. With an HP 11713A Attenuator Driver, or an HP 70611 Driver for MMS based systems, the attenuators are easily integrated into a Hewlett-Packard Interface Bus (HPIB) automated system.

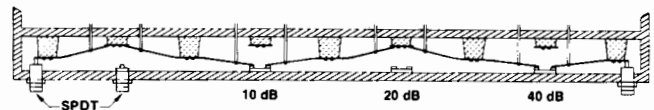

Figure 1. 70 dB plus SPDT.

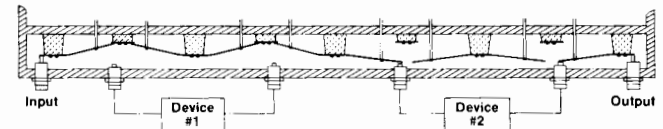

Figure 2. Dual transfer switch showing device #2 inserted in signal path.

### Custom Attenuator and Switch Combinations

Custom step attenuator/switch combinations are possible with the HP 8494/5/6/7 attenuator family. Examples can be as simple as adding a SPDT switch section to a standard 70 dB attenuator (figure 1) or creating a dual transfer switch (figure 2). See the HP Microwave Test Accessories Catalog for more information.

### HP 11716A/B Interconnection kits

Quickly and conveniently connect 1 dB step and 10 dB step attenuators together to achieve greater dynamic range with 1 dB steps. The 11716A/B interconnect kits contain a rigid RF cable, mounting bracket, and necessary hardware to connect any pair of HP 8494/5/6/7 attenuators in series (see photo above). Attenuators must be ordered separately.

### Ordering Information

- HP 11716A Interconnect Kit (Type N)
- HP 11716B Interconnect Kit (7mm)

**Price**  
\$200  
\$290

### HP 33320 Series OEM Step Attenuators

The HP 33320 series step attenuators are compact versions of the HP 8495/6/7 benchtop attenuators. They offer the same specifications, but are configured to easily fit into microwave systems and instruments. Both manual and programmable versions are available; the manual version occupies less than 1.5 square inches of panel space. OEM quantity discounts are available for the HP 33320 series; the HP 33320 series has a five million cycles per step reliability guarantee.

Programmable models are supplied with a five-foot cable, fitted with a round 12-pin Viking connector that mates with the HP 11713 Attenuator/Switch Driver. A flat ribbon cable with a DIP-type connector, compatible with a standard 14-pin DIP IC socket, is also available. For further details, request the RF and Microwave Designer's Catalog from your nearest HP sales representative.



**How to Order the HP 8494/5/6/7 Series Attenuators**

Each order must include basic model number, suffix letter, and connector option.

Optional calibration data.

**HP 8494 A Option 001 Option 890**

- 4** (1 dB step, 11 dB max)
  - 5** (10 dB step, 70 dB max)
  - 6** (10 dB step, 110 dB max)
  - 7** (10 dB step, 90 dB max)
  - A** (Manual, dc—4 GHz)
  - B** (Manual, dc—18 GHz)
  - D** (Manual, dc—26.5 GHz)\*
  - G** (Programmable, dc—4 GHz)
  - H** (Programmable, dc—18 GHz)
  - K** (Programmable, dc—26.5 GHz)\*
  - 001** (N-Female)
  - 002** (SMA Female)
  - 003** (APC-7)
  - 004** (3.5 mm Female)\*
- \* Option 004 is only available on 'D' and 'K' models.

**HP 355 Series, 8494/5/6/7 Series Specifications**

HP Model and (Switching Mode: OEM Model No.)	Frequency Range (GHz)	Incremental Attenuation (dB)	SWR Maximum (50 Ω Nominal)	Insertion Loss (0 dB setting)	Attenuation Accuracy	Power Rating, Minimum Life	Solenoid Voltage Speed Power	Size, Shipping Weight	Connector Options Available	Price
<b>355C</b> (Manual)	dc—1	0—12 1 dB steps	dc—0.25 GHz: 1.2 dc—0.5 GHz: 1.3 dc—1.0 GHz: 1.5	0.11 dB + 1.39 dB/GHz	±0.1 dB @ 1000 Hz ±0.25 dB: dc—0.5 GHz ±0.35 dB: dc—1.0 GHz	0.5 W avg 350 W peak 0.3 million cycles per section	—	67 H × 70 W × 152 mm D (2.6" × 2.75" × 6")	BNC (f) See Note 1	\$645
<b>355E</b> (Programmable)										15—18 V <65 ms 3.0 W
<b>355D</b> (Manual)	dc—1	0—120 10 dB steps	dc—0.25 GHz: 1.2 dc—0.5 GHz: 1.3 dc—1.0 GHz: 1.5	0.11 dB + 1.39 dB/GHz	±0.3 dB @ 1000 Hz ±1.5 dB to 90 dB, and ±3 dB to 120 dB @ 1 GHz	0.5 W avg 350 W peak 0.3 million cycles per section	—	67 H × 70 W × 152 mm D (2.6" × 2.75" × 6")	BNC (f) See Note 1	\$645
<b>355F</b> (Programmable)										15—18 V <65 ms 3.0 W
<b>8494A</b> (Manual) (33320A)	dc—4	0—11 1 dB Steps	1.5	0.6 dB + 0.09 dB/GHz	±0.2 dB: 1—2 dB ±0.3 dB: 3—6 dB ±0.4 dB: 7—10 dB ±0.5 dB: 11 dB	1 W avg 100 W peak 10 μs max. 5 million cycles per section	—	43 H × 73 W × 159 mm D (1.7" × 2.9" × 6.2")	001 002 003 See Note 2	\$620
<b>8494G</b> (Programmable) (33320G)										20—30 V <20 ms 2.7 W
<b>8494B</b> (Manual) (33320B)	dc—18	0—11 1 dB steps	dc—8 GHz: 1.5 dc—12.4 GHz: 1.6 dc—18 GHz: 1.9	0.6 dB + 0.09 dB/GHz	dc—12.4 GHz ±0.3 dB: 1—2 dB ±0.4 dB: 3—4 dB ±0.5 dB: 5—6 dB ±0.6 dB: 7—10 dB ±0.7 dB: 11 dB dc—18 GHz ±0.7 dB: 1—5 dB ±0.8 dB: 6—9 dB ±0.9 dB: 10—11 dB	1 W avg 100 W peak 10 μs max. 5 million cycles per section	—	43 H × 73 W × 159 mm D (1.7" × 2.9" × 6.2")	001 002 003 See Note 2	\$915
<b>8494H</b> (Programmable) (33320H)										20—30 V <20 ms 2.7 W
<b>8495A</b> (Manual) (33320A)	dc—4	0—70 10 dB steps	1.35	0.4 dB + 0.07 dB/GHz	±1.7% of setting or ±0.4 dB, whichever is greater	1 W avg 100 W peak 10 μs max. 5 million cycles per section	—	43 H × 73 W × 130 mm D (1.7" × 2.9" × 5.1")	001 002 003 See Note 2	\$515
<b>8495G</b> (Programmable) (33320G)										20—30 V <20 ms 2.7 W
<b>8495B</b> (Manual) (33321B)	dc—18	0—70 10 dB steps	dc—8 GHz: 1.35 dc—12.4 GHz: 1.5 dc—18 GHz: 1.7	0.4 dB + 0.07 dB/GHz	±3%: dc—12.4 GHz ±4%: dc—18 GHz % in dB from Atten. Setting	1 W avg 100 W peak 10 μs max. 5 million cycles per section	—	43 H × 73 W × 130 mm D (1.7" × 2.9" × 5.1")	001 002 003 See Note 2	\$670
<b>8495H</b> (Programmable) (33321H)										20—30 V <20 ms 2.7 W
<b>8495D</b> (Manual) (33321D)	dc—26.5	0—70 10 dB steps	dc—6 GHz: 1.25 6—12.4 GHz: 1.45 12.4—18.0 GHz: 1.6 18.0—26.5 GHz: 1.8	0.6 dB + 0.09 dB/GHz	±0.3 dB at 6 GHz 10 dB attenuation to ±2.8 dB at 26.5 GHz 90 dB attenuation. See Data Sheet 5952-8278 for details.	1 W avg 100 W peak 10 μs max. 5 million cycles per section	—	43 H × 52 W × 159 mm D (1.7" × 2.1" × 6.2")	004 3.5 mm See Note 2	\$875
<b>8495K</b> (Programmable) (33321K)										20—30 V <20 ms 2.7 W
<b>8496A</b> (Manual) (33322A)	dc—4	0—110 10 dB steps	1.5	0.6 dB + 0.09 dB/GHz	±1.7% of setting or ±0.4 dB, whichever is greater	1 W avg 100 W peak 10 μs max. 5 million cycles per section	—	43 H × 73 W × 159 mm D (1.7" × 2.9" × 6.2")	001 002 003 See Note 2	\$620
<b>8496G</b> (Programmable) (33322G)										20—30 V <20 ms 2.7 W
<b>8496B</b> (Manual) (33322B)	dc—18	0—110 10 dB steps	dc—8 GHz: 1.5 dc—12.4 GHz: 1.6 dc—18 GHz: 1.9	0.6 dB + 0.09 dB/GHz	±3%: dc—12.4 GHz ±4%: dc—18 GHz % in dB from Atten. Setting	1 W avg 100 W peak 10 μs max. 5 million cycles per section	—	43 H × 73 W × 159 mm D (1.7" × 2.9" × 6.2")	001 002 003 See Note 2	\$915
<b>8496H</b> (Programmable) (33322H)										20—30 V <20 ms 2.7 W
<b>8497K</b> (Programmable) (33323K)	dc—26.5	0—90 10 dB steps	dc—6 GHz: 1.25 6—12.4 GHz: 1.45 12.4—18.0 GHz: 1.6 18.0—26.5 GHz: 1.8	0.6 dB + 0.09 dB/GHz	±0.3 dB at 6 GHz 10 dB attenuation to ±2.8 dB at 26.5 GHz 90 dB attenuation. See Data Sheet 5952-8278 for details.	1 W avg 100 W peak 10 μs max. 5 million cycles per section	5 V or 24V	43 H × 52 W × 143 mm D (1.7" × 2.1" × 5.6")	004 3.5 mm See Note 2	\$1,320
<b>Option 890 Calibration Data</b>	<b>Option 890 Frequency List (MHz)</b> DC to 4 GHz Models: 100, 300, 500, 700, 900, 1000, 1250, 1500, 1750, 2000, 2500, 3000, 3500, 4000 DC to 18 GHz Models: Same as above to 4000 MHz, every 500 MHz to 16000 (plus 12400 MHz), every 250 MHz from 16000 to 18000.					<b>Models</b> 8494A/G, 8496A/G, 33320A/G, 33322A/G 8495A/G, 33321A/G  8494B/H, 8496B/H, 33320B/H, 33322B/H 8495B/H, 33321B/H 8495D/K, 8497K			<b>Option 890 Price</b> add \$25 add \$25  add \$35 add \$35 add \$50	
<p>Note 1: 355C/D/E/F connector options (BNC (f) standard) Option 001 N(f) Option 005 TNC(f) Option 007 Transistor protection (355E/F only)</p> <p>Note 2: 8494/5/6/7 orders must specify connector option. See ordering example above. Option 001 N(f) Option 002 SMA(f) Option 003 APC-7 Option 004 3.5 mm (HP 8495D/K, 8497K only)</p>										

For same-day shipment, call HP DIRECT at 800-538-8787.

# MICROWAVE TEST ACCESSORIES

## High Performance Programmable Step Attenuators

HP 84904/6/7K/L



HP 84904/6/7K/L

### High Performance Coaxial Attenuators

The HP 84904/6/7 family of programmable step attenuators offers unmatched attenuation performance to 40 GHz. The new K family brings superior accuracy and reliability to 26.5 GHz, and the L family offers unparalleled performance to 40 GHz.

Both families offer the selection, performance, and reliability expected from HP attenuators: attenuation range of 11, 70, or 90 dB, 1 dB and 10 dB step sizes, 5 million cycles per section, better than 0.03 dB repeatability, connector size options, and now the choice of male (plug) or female (jack) connectors. Connector choices include precision 3.5 mm or 2.92 mm on the 26.5 GHz K model, and precision 2.4 mm or 2.92 mm on the L model. *While the 2.92mm connector format is compatible with both 3.5 mm and SMA connectors, Hewlett Packard recommends the more rugged 2.4 mm and 3.5 mm connectors.*

#### Other Features

- Same drive circuits and solenoids as HP 8494/5/6/7 family
- Switching time under 20 milliseconds (includes settling time)
- Permanent magnet latching design; attenuators will withstand over 10 g shock without performance degradation
- Automatic DC circuit interrupts cut power consumption and simplify drive circuit design
- Equipped with 10-pin DIP plugs (m). Optional cables with 10-pin DIP socket (f) connectors are available; see below.
- NIST traceable attenuation and SWR data (Option 890)

Drive options include the HP 11713A Attenuator/Switch driver, which permits users to easily integrate the attenuator into HP-IB compatible automatic test systems and the new HP 70611 MMS Attenuator/Switch driver. Cabling options include 8 or 16-inch ribbon

cables (HP 11764C/D) with a 10 pin DIP socket (f) and a 14-pin DIP plug for easy connection to standard 14-pin DIP IC sockets, a 5-foot Interconnect Cable (HP 11764A) with 10-pin DIP socket (f) and a "Viking" cable for the HP 11713 driver, and a 5-foot Interconnect Cable (HP 11764 B) with a 10-Pin DIP socket (f) and bare leads for custom applications.

#### Ordering Information

##### Attenuators

Attenuator Model	Price
HP 84904L 0-11 dB, 1 dB steps, 40 GHz	\$2400
HP 84904K 0-11 dB, 1 dB steps, 26.5 GHz	\$1850
HP 84906L 0-90 dB, 10 dB steps, 40 GHz	\$2400
HP 84906K 0-90 dB, 10 dB steps, 26.5 GHz	\$1850
HP 84907L 0-70 dB, 10 dB steps, 40 GHz	\$2200
HP 84907K 0-70 dB, 10 dB steps, 26.5 GHz	\$1675
Opt 100 Male 2.4 mm connector	+\$75
Opt 104 Male 3.5 mm connector	+\$75
Opt 106 Male 2.92 mm connector	+\$125
Opt 006 Female 2.92 mm conn	+\$75
Opt 890 Atten & SWR data	+\$65

##### Attenuator Accessories

Accessory Model	Price
HP 11764A Interconnect Cable with 10-pin socket (f) to "Viking" connector for HP 11713A	\$35
HP 11764B Interconnect Cable with 10-pin DIP socket (f) and bare leads	\$10
HP 11764C Interconnect Cable- 203-mm (8") ribbon cable, 10-pin DIP socket, 14-pin DIP plug	\$5
HP 11764D Interconnect Cable-406-mm (16") ribbon cable, 10-pin DIP socket, 14-pin DIP plug	\$5

### HP 84904/6/7K/L Specifications

HP Model	Frequency Range	Incremental Attenuation	SWR Maximum (50 nominal) Std & (Opt 006)	Insertion Loss (0 dB setting)	Shipping Weight	Connector Options Available	Price
HP 84904L (33324L)	dc-40 GHz	0-11 dB 1 dB steps	dc-12.4 GHz: 1.3 (1.5) 12.4-34 GHz: 1.7 (1.9) 34-40 GHz: 1.8 (2.0)	0.8 dB+0.04 dB/GHz	291g (10.3 oz)	2.4 mm std	\$2400
						Opt 100	+\$75
HP 84904K (33324K)	dc-26.5 GHz					Opt 006	+\$75
						Opt 106	+\$125
HP 84906L (33326L)	dc-40 GHz	0-90 dB 10 dB steps	dc-12.4 GHz: 1.3 (1.5) 12.4-34 GHz: 1.7 (1.9) 34-40 GHz: 1.8 (2.0)	0.8 dB+0.04 dB/GHz	291g (10.3 oz)	Opt 890	+\$65
						2.4 mm std	\$2400
HP 84906K (33326K)	dc-26.5 GHz					Opt 006	+\$75
						Opt 100	+\$75
HP 84907L (33327L)	dc-40 GHz	0-70 dB 10 dB steps	dc-12.4 GHz: 1.25 (1.4) 12.4-34 GHz: 1.5 (1.7) 34-40 GHz: 1.7 (1.9)	0.6 dB+0.03 dB/GHz	229g (8.1 oz)	Opt 106	+\$125
						Opt 890	+\$65
HP 84907K (33327K)	dc-26.5 GHz					2.4 mm std	\$2200
						Opt 006	+\$75
						Opt 100	+\$75
						Opt 106	+\$125
						Opt 890	+\$65
						3.5 mm	
						Opt 104	+\$75
						Opt 890	+\$65

Attenuation Accuracy	
dc-26.5 GHz	26.5-40 GHz
0.4 dB: 1 dB	0.6 dB: 1 dB
0.5 dB: 2 dB	0.6 dB: 2 dB
0.7 dB: 3 dB	0.7 dB: 3 dB
0.7 dB: 4 dB	0.7 dB: 4 dB
0.7 dB: 5 dB	0.7 dB: 5 dB
0.7 dB: 6 dB	0.8 dB: 6 dB
0.8 dB: 7 dB	0.9 dB: 7 dB
0.8 dB: 8 dB	0.9 dB: 8 dB
0.85 dB: 9 dB	1.0 dB: 9 dB
0.9 dB: 10 dB	1.1 dB: 10 dB
1.10 dB: 11 dB	1.2 dB: 11 dB
	0.5 dB: 10 dB
	0.6 dB: 20 dB
	0.7 dB: 30 dB
	1.0 dB: 40 dB
	1.2 dB: 50 dB
	1.6 dB: 60 dB
	1.9 dB: 70 dB
	2.3 dB: 80 dB
	2.7 dB: 90 dB

Sensitivity Power dB/dB/Watt (Temperature dB/dB/°C): 0.001 (0.0001)

Power Rating: 1W Ave, 50W Peak, 10 uS Max pulse width

Minimum Life: 5 million cycles per section

Solenoid Voltage/Speed/Power: 20-30V / <20 ms / 2.7 W

# MICROWAVE TEST ACCESSORIES

Custom Switch Matrixes

HP70611/12/13, 11713A

355

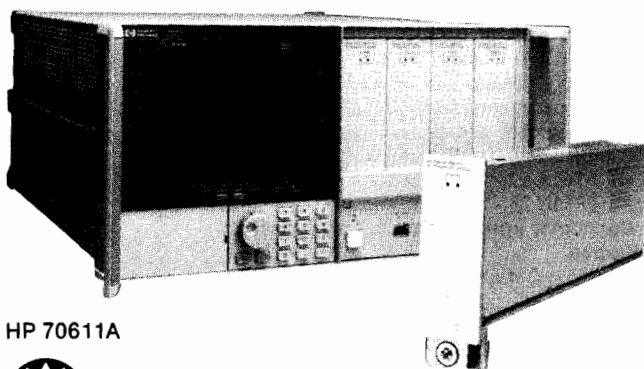

HP 70611A



## HP 70611A Switch/Attenuator Driver for MMS

The HP 70611A is a 1/8 MMS module capable of driving up to 248 electromechanical switches or attenuator switch sections. The HP 70611A is MSIB, SCPI, and HB-IP compatible. In addition to being programmable, the HP 70611A features an extremely user-friendly manual interface via the HP 70004 color display. The highlight of the manual interface is the operator's ability to custom configure groups of switch control lines and their settings, then identify these switch configurations with a user defined alphanumeric label. In this manner, end-users of the HP 70611A can define custom menus with their own identification labels for simplified manual control.

The HP 70611A controls switches or attenuator sections in banks of 31 (8 banks total) through individual I/O cards which are, in turn, directly wired to the switches or attenuators. Option 001 of the HP 70611A includes one I/O driver card. The HP 70611A, option 001, is capable of driving 31 switches or attenuator sections. Additional drive capacity can be added through the purchase of supplementary I/O driver cards, HP part number HP 84940A.

For additional information on the HP 70611A, see the Modular Measurement System (MMS) Section of this catalog on page 189.

## HP 70612 and HP 70613: MMS Interface Boxes

In addition to custom interface boxes, HP offers off-the-shelf interface solutions in MMS-compatible modules.

The HP 70612 (1x6) and 70613 (2x5) are common-highway switch matrixes available in 2/8's MMS modules, with integrated controllers. They are equipped with front panel indicators to facilitate manual use and an internal controller with all of the capabilities of the HP 70611A Switch/Attenuator Driver.

A variety of options are available in both these products including performance to 26.5 GHz, terminated or unterminated ports, on-board attenuation, and choice of port locations.

For more detailed descriptions of these products, refer to the Modular Measurement System section of this catalog, page 189.

Custom MMS interface box solutions are also available from Hewlett-Packard. Please call your local HP sales representative for more information.

### Switch Driving Options

The HP 8760 series of switches are designed to be driven by a variety of switch and attenuator drivers. For more information on those listed refer to other sections of this catalog.

### Ordering Information

	Price
HP 11713A Attenuator/Switch Driver	\$1750
HP 11717A Attenuator/Switch Rackmount Support Kit	\$55
HP 11761A HP 8765A/HP 11713A Adapter Cable	\$35
HP 11764A HP 84904/6/7 to HP 11713A Drive Cable	\$35
HP 11764B HP 84904/6/7 to 5-foot ribbon cable with 14-pin DIP connector	\$10
HP 34530T Microwave Switch terminal block for HP 3235A. Holds up to 4 HP 8762/3/4 switches	\$325

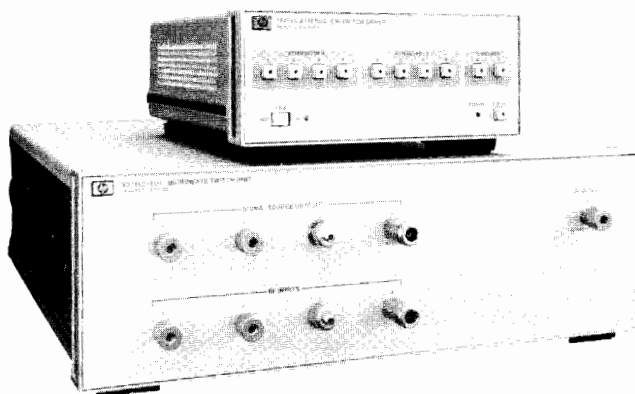

HP 11713A

HP 44476B microwave switch module for HP 3488A. Holds up to 3 HP 8762/3/4 OPT011 switches \$485

HP 70611A MMS switch controller \$3400

Opt 001 add switch driver card +\$1000

HP 70612A (1x6) and 70613A (2x5) MMS 18 GHz switching modules w/controller and w/terminated switches \$8400

Opt 001 Delete Controller Card -\$1200

Opt 003 Unterminated switches replace standard -\$1000

Opt 004 Add 0-11 dB Step Attenuator +\$895

Opt 005 Add 0 - 110 dB Step Attenuator +\$825

Opt 007 Rear Panel output connector +\$250

HP 70612C (1x6) and 70613C (2x5) MMS 26.5 GHz Switching modules w/controller and w/terminated switches \$9400

Opt 001 Delete Controller Card -\$1200

Opt 003 Unterminated switches replace std. -\$1000

Opt 004 Add 0-11 dB step attenuator +\$1800

Opt 005 Add 0 - 90 dB step attenuator +\$1300

Opt 007 Rear Panel output connector +\$250

## Custom Switch Matrixes

HP microwave switch matrixes are custom configured to provide multiple path routing of signals under computer control, and often can include calibration paths for checking system instruments and switching. Hewlett-Packard can also include other components required to build a high-performance solution, including step attenuators, mixers, couplers, power splitters, detectors, power sensors, and noise sources. Each HP matrix is fully documented with a general description, RF and dc schematics, interior parts identifier photos, parts list, drive logic, and operation data.

More information on how to specify and order a custom matrix from Hewlett-Packard is available in Product Note 8760-1 (HP literature number 5959-7860).

## HP 11713A Attenuator/Switch Driver

The HP 11713A attenuator/switch driver provides HP-IB control of up to two programmable attenuators of the HP 8494/5/6 or HP 33320/1/2 series and concurrently up to two electromechanical switches (e.g., HP 8761 or HP 8762 series). The HP 11713A can also supply +24V common and ten pairs of current sinking contacts (total current less than 1.25A) to control up to ten relays. No external power supply is needed. The HP 11713A includes an integral power supply (with short circuit protection) that can provide 125 milliamps at 24 volts to all contacts for control of the attenuators and switches. Each HP 11713A is provided with two plug-in drive cables for the programmable attenuators.

The HP 11713A also features convenient front-panel control for manual activation of individual attenuation sections and switches in local mode. Switching time for the drivers is less than 10 milliseconds.

# MICROWAVE TEST ACCESSORIES

## Coaxial Switches

HP 8761A/B, 8762/3/4, 8765, 8766/7/8/9 Series

### Coaxial Switches

HP coaxial switches feature low SWR, low insertion loss, and excellent isolation. All HP switches use latching solenoids and break-before-make switching circuits.

The **HP 8761A/B** is an SPDT switch for dc to 18 GHz use. Each port has six connector options plus a 50  $\Omega$  termination, making it useful for switching between components with different connector types or for making switch "trees".

The **HP 8762A**, **HP 8762B** and **HP 8762C** switches (dc - 4 GHz, dc - 18 GHz and dc - 26.5 GHz) are also SPDT type. They feature exceptional isolation of 90 dB to 18 GHz and internally switched 50  $\Omega$  loads so that all ports maintain a 50  $\Omega$  match. The internal loads are rated for 1 watt average or 100 watts peak (10  $\mu$ S pulse width).

The **HP 8762/3/4** switches all use latching solenoids and have dc circuit interrupts to cut off solenoid current when switching is complete.

The **HP 8763A**, **HP 8763B** and **HP 8763C** switches (dc - 4 GHz, dc - 18 GHz and dc - 26.5 GHz) are used for transfer switching. They can be used to insert or remove a component from a signal path. They can also be used as the intersection switching elements in a larger microwave matrix. They include one internal 50  $\Omega$  switched load.

The **HP 8764A**, **HP 8764B**, and **HP 8764C** switches (dc - 4 GHz, dc - 18 GHz and dc - 26.5 GHz) are five port switches with essentially the same internal structure as the HP 8762 switches. Elimination of the internal load makes it possible to utilize the extra ports for a variety of purposes, such as adding external high power loads to extend power handling capability or reversing signal path.

The **HP 8765** series switches are single-pole double-throw switches, which offer outstanding performance with a life of 5 million cycles (HP 8765A, dc - 4 GHz; HP 8765B, dc - 20 GHz; HP 8765C, dc - 26.5 GHz). They are designed for long life and high reliability. Unlike the HP 8762 switches, they do not have internal switched loads or dc current interrupts. Voltage options cover the complete range from 4.5 Vdc to 30 Vdc. The standard HP 8765 comes with a ribbon cable and .025 square inch pins in a single inline connector for convenient connection to the HP 11761A adapter cable or to any other Berg single inline connector package. Solder terminals are also available. Other features include magnetically latching solenoids and configurable solenoid control.

### HP 8766/7/8/9K Series Single-Pole Multi-throw switches

The HP 8766/7/8/9K series switches are modified versions of the coaxial edgeline design (dc - 26.5 GHz) for applications requiring single-pole, 3-throw, 4-throw, 5-throw, or 6-throw coaxial switch.

These compact switches offer the same reliability, repeatability (typically 0.01 dB), and long life (5 million switching cycles per section) as the HP 8494/5/6/7K series step attenuators from which they are derived.

The switches are also available with flat ribbon cables and DIP-type connectors compatible with standard 14-pin DIP IC sockets.

Isolation and Insertion Loss vary with frequency and depend upon the port selected on the HP 8866/7/8/9 switch. For applications where isolation and insertion loss is critical, it is suggested that you obtain a copy of the data sheet for further application information. Ask your HP Sales Representative for the data sheet "HP 8766,7,8,9K Microwave Single-Pole Multi-throw Switches" (PN 5959-7831).

### HP-IB Compatible

All of the HP 8760 series of switches can be remotely controlled by the HP-IB interface bus with the HP 11713A Attenuator/Switch Driver, the HP 3235A, HP 3488A, or HP E1700A. For the HP 70000 Modular Measurement System, the HP 70611A is available to drive up to 31 switches.

### Ordering Information

#### HP 8761A/B Coaxial Switch

Specify voltage and connectors (including built-in 50-ohm terminations) by alphabetic suffix on the switch model number and the appropriate three-digit option number. Specify all connectors.

**HP 8761A** 12 - 15 volt solenoids \$360

**HP 8761B** 24 - 30 volt solenoids \$360

#### Connector options (Port 1, Port 2, Port C)

##### Option

code	Connector type	Option code	Connector type
0	N(f)	4	APC-7 for UT-250 coax
1	N(m)	5	SMA(f)
2	APC-7 w/threaded sleeve	6	SMA(m)
3	APC-7 w/coupling nut	7	50 $\Omega$ termination

#### HP 8762A/B/C, HP 8763A/B/C, HP 8764A/B/C Coaxial Switches

Specify the frequency and voltage by the alphabetic suffix and option number. The standard model has 24V solenoids.

**HP 8762A** SPDT, dc - 4 GHz \$430

**HP 8762B** SPDT, dc - 18 GHz \$480

**HP 8762C** SPDT, dc - 26.5 GHz \$555

**HP 8763A** 4-Port, dc - 4 GHz \$480

**HP 8763B** 4-Port, dc - 18 GHz \$530

**HP 8763C** 4-Port, dc - 26.5 GHz \$605

**HP 8764A** 5-Port, dc - 4 GHz \$480

**HP 8764B** 5-Port, dc - 18 GHz \$530

**HP 8764C** 5-Port, dc - 26.5 GHz \$605

**Opt 011**, 5 Vdc Solenoids \$0

**Opt 015**, 15 Vdc Solenoids \$0

#### HP 8765A/B/C Coaxial Switches

A voltage option must be ordered with the main-frame. Specify frequency, voltage, dc connectors, and ribbon cable extension options by alphabetic suffix and option number.

**HP 8765A** SPDT, dc - 4 GHz \$190

**HP 8765B** SPDT, dc - 20 GHz \$220

**HP 8765C** SPDT, dc - 26.5 GHz \$270

**Opt 005** 5 Vdc solenoids \$0

**Opt 010** 10 Vdc solenoids \$0

**Opt 015** 15 Vdc solenoids \$0

**Opt 024** 24 Vdc solenoids \$0

**Opt 100** Solder terminals \$0

**Opt 108** 8-inch ribbon cable extension +\$10

**Opt 116** 16-inch ribbon cable extension +\$10

**Opt 890** Calibration data

for HP 8765A +\$25

for HP 8765B +\$35

for HP 8765C +\$50

#### HP 8766K, HP 8767K, HP 8768K, HP 8769K Coaxial Switches

Specify RF connectors (and frequency), solenoid voltages, dc connectors by option number. Standard unit is 24 Vdc, 3.5 mm(f) RF connectors (dc - 26.5 GHz) and viking-type dc connector.

**HP 8766K** SP3T multi-port switch \$630

**HP 8767K** SP4T multi-port switch \$690

**HP 8768K** SP5T multi-port switch \$750

**HP 8769K** SP6T multi-port switch \$900

**Opt 002** Replace 3.5mm (f) w/ SMA(m) connectors -\$25

**Opt 008** 8-inch ribbon cable w/DIP connector -\$50

**Opt 011** 5 Vdc solenoids \$0

**Opt 015** 15 Vdc solenoids \$0

**Opt 016** 16-inch ribbon cable w/DIP connector -\$50

**Opt 890** Calibration data \$35

☎ For Same day shipment, call HP DIRECT at 800-538-8787

# MICROWAVE TEST ACCESSORIES

## Coaxial Switches

### HP 8760 Series Product Specifications

357

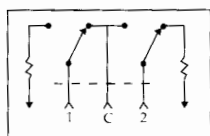
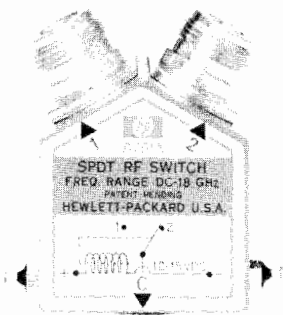

HP 8762

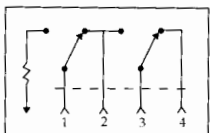

HP 8763

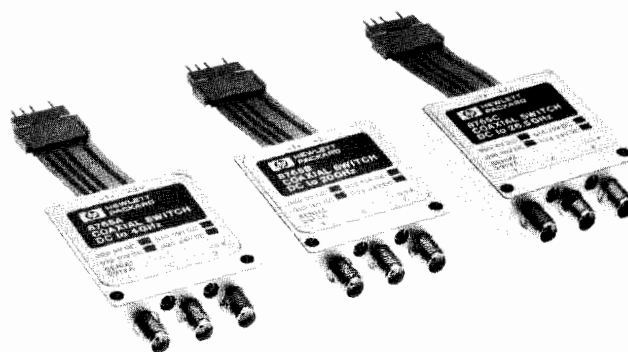

HP 8761A

HP 8765A, HP 8765B, HP 8765C

#### HP 8761A/B, 8762/3/4A/B/C, 8765A/B/C, 8766/7/8/9K Specifications

HP Model (OEM Model)	Frequency Range (GHz)	SWR Nominal	Insertion Loss	Isolation	Switching Speed	RF Connectors	Dimensions HxWxD (mm)	Shipping Weight (grams)	Price
HP 8761A SPDT	dc-18	<1.2 to 12.4 GHz <1.25 to 18 GHz	0.8 dB @ 18 GHz	>50 dB to 12.4 GHz >45 dB to 18 GHz	35-50 mS	See table on page 356	41x38x38	300	\$360
HP 8761B SPDT	dc-18	<1.2 to 12.4 GHz <1.25 to 18 GHz	0.8 dB @ 18 GHz	>50 dB to 12.4 GHz >45 dB to 18 GHz	35-50 mS	See Table on page 356	41x38x38	300	\$360
HP 8762A SPDT (33311A)	dc-4 GHz	<1.1 to 2 GHz <1.2 to 4 GHz	<0.2 dB @ 2 GHz <0.25 dB @ 4 GHz	>100 dB to 4 GHz	<30 mS	SMA(f)	54x53x14	220	\$430
HP 8762B SPDT (33311B)	dc-18	<1.10 to 2 GHz <1.2 to 12.4 GHz <1.3 to 18 GHz	<0.2 dB @ 2 GHz <0.5 dB @ 18 GHz	>90 dB to 18 GHz	<30 mS	SMA(f)	54x53x14	220	\$480
HP 8762C SPDT (33311C)	dc-26.5	<1.15 to 2 GHz <1.25 to 12.4 GHz <1.4 to 18 GHz <1.8 to 26.5 GHz	<0.2 dB @ 2 GHz <0.5 dB @ 18 GHz <1.25 @ 26.5 GHz	>90 dB to 18 GHz >50 dB to 26.5 GHz	<30 mS	3.5 mm(f)	54x53x14	220	\$555
HP 8763A 4-port (33312A)	dc-4 GHz	<1.1 to 2 GHz <1.2 to 4 GHz	<0.2 dB @ 2 GHz <0.25 dB @ 4 GHz	>100 dB to 4 GHz	<30mS	SMA(f)	54x53x14	220	\$480
HP 8763B 4-Port (33312B)	dc-18	<1.10 to 2 GHz <1.2 to 12.4 GHz <1.3 to 18 GHz	<0.2 dB @ 2 GHz <0.5 dB @ 18 GHz	>90 dB to 18 GHz	<30mS	SMA(f)	54x53x14	220	\$530
HP 8763C 4-port (33312C)	dc-26.5	<1.15 to 2 GHz <1.25 to 12.4 GHz <1.4 to 18 GHz <1.8 to 26.5 GHz	<0.2 dB @ 2 GHz <0.5 dB @ 18 GHz <1.25 @ 26.5 GHz	>90 dB to 18 GHz >50 dB to 26.5 GHz	<30 mS	3.5 mm(f)	54x53x14	220	\$605
HP 8764A 5-port (33313A)	dc-4 GHz	<1.1 to 2 GHz <1.2 to 4 GHz	<0.2 dB @ 2 GHz <0.25 dB @ 4 GHz	>100 dB to 4 GHz	<30 mS	SMA(f)	54x53x14	220	\$480
HP 8764B 5-port (33313B)	dc-18	<1.10 to 2 GHz <1.2 to 12.4 GHz <1.3 to 18 GHz	<0.2 dB @ 2 GHz <0.5 dB @ 18 GHz	>90 dB to 18 GHz	<30mS	SMA(f)	54x53x14	220	\$530
HP 8764C 5-port (33313C)	dc-26.5	<1.15 to 2 GHz <1.25 to 12.4 GHz <1.4 to 18 GHz <1.8 to 26.5 GHz	<0.2 dB @ 2 GHz <0.5 dB @ 18 GHz <1.25 dB @ 26.5 GHz	>90 dB to 18 GHz >50 dB to 26.5 GHz	<30mS	3.5 mm(f)	54x53x14	220	\$605
HP 8765A SPDT (33314A)	dc-4	<1.2 to 4 GHz	<0.3 dB @ 4 GHz	>110 dB to 4 GHz	<15 mS	SMA(f)	14x33x45	200	\$190
HP 8765B SPDT (33314B)	dc-20	<1.3 to 4 GHz <1.35 to 12.4 GHz <1.45 to 18 GHz <1.7 to 20 GHz	<0.3 dB @ 4 GHz <0.7 dB @ 20 GHz	>110 dB to 4 GHz >75 dB to 20 GHz	<15 mS	SMA(f)	14x33x45	200	\$220
HP 8765C SPDT (33314C)	dc-26.5	<1.25 to 4 GHz <1.45 to 18 GHz <1.7 to 26.5 GHz	<0.3 dB @ 4 GHz <0.75 dB @ 20 GHz <1.0 dB @ 26.5 GHz	>110 dB to 4 GHz >68 dB to 20 GHz >50 dB to 26.5 GHz	<15 mS	3.5 mm(f)	14x33x45	200	\$270
HP 8766K SP3T (HP 33363K)	dc-26.5 or dc-18 for opt. 002	<1.3 to 8 GHz <1.5 to 12.4 GHz <1.6 to 18 GHz <1.8 to 26.5 GHz	Port 1: 0.2 dB + 0.05 dB/GHz	Consult Technical Data Sheet	<20 mS	3.5 mm(f)	45x82x23	178	\$630
HP 8767K SP4T (HP 33364K)	dc-26.5 or dc-18 for opt. 002	<1.3 to 8 GHz <1.5 to 12.4 GHz <1.6 to 18 GHz <1.8 to 26.5 GHz	Port 2: 0.2 dB + 0.06 dB/GHz		<20 mS	3.5 mm(f)	45x105x23	235	\$690
HP 8768K SP5T (HP 33365K)	dc-26.5 or dc-18 for opt. 002	<1.3 to 8 GHz <1.5 to 12.4 GHz <1.6 to 18 GHz <1.8 to 26.5 GHz	Port 3: 0.2 dB + 0.08 dB/GHz		<20 mS	3.5 mm(f)	45x133x23	292	\$750
HP 8769K SP6T (HP 33366K)	dc-26.5 or dc-18 for opt. 002	<1.3 to 8 GHz <1.5 to 12.4 GHz <1.8 to 18 GHz <2.05 to 26.5 GHz	Port 4: 0.25dB + 0.095 dB/GHz		<20 mS	3.5 mm(f)	45x160x23	349	\$900
			Port 5: 0.25 dB + 0.108 dB/GHz						
			Port 6: 0.25 dB + 0.12 dB/GHz						

☎ For same-day shipment, call HP DIRECT at 800-538-8787.

# MICROWAVE TEST ACCESSORIES

## Coaxial and Waveguide Detectors

HP 423B, 8470 Series, 422 Series, 83036C



HP 8474 Series



HP 8471 D/E



HP 83036C

### Low-Barrier Schottky Diode Detectors

#### HP 423B, HP 8472B, HP 8473B/C

These LBSD detectors have been widely used for many years in a variety of applications including leveling and power sensing. They offer good performance and ruggedness. Matched pairs (option 001) offer very good detector tracking. A video load option (option 002) extends the square-law region to at least 0.1 mW (-10 dBm).

### Planar-Doped Barrier Detectors

#### HP 8471D/E

The HP 8471D and HP 8471E are economy detectors based on the planar doped barrier diodes. The PDB diodes give them superior frequency response, square law response, and temperature performance. The HP 8471D has a BNC(m) input connector and a frequency range of 100 KHz to 2 GHz, making it ideal for use in RF and low microwave applications. The HP 8471E has an SMA(m) input connector and an SMC(m) output connector. Its frequency range is 10 MHz to 12 GHz. Both models come standard with a negative output, a positive output can be specified as an option (option 103). An optimal square law load (option 102) and 75-ohm input impedance (option 175) is also available on the HP 8471D.

#### HP 8473D/E Planar-Doped Barrier Detectors

The HP 8473D and 8473E detectors were the first gallium arsenide, planar-doped barrier diodes introduced. They feature broadband performance and excellent flatness vs. frequency, along with superior temperature stability. The HP 8473D is available with a 3.5mm (m) RF connector and a BNC output connector. The HP 8473E features a 2.4mm (m) RF connector with a BNC output connector.

#### HP 8474A/B/C/D/E High Performance Planar-Doped Barrier Detectors

These detectors are the newest addition to the HP family of high-performance detectors. Utilizing a gallium arsenide, planar doped barrier diode as the detecting element, these detectors offer superior performance when compared to earlier detector designs. They feature extremely flat frequency response over their entire band of operation (typically better than  $\pm 1$  dB to 50 GHz) and very good frequency response stability versus temperature. For applications where broadband frequency coverage is not required, octave band options are

available in specific bands, usually with improved frequency response specifications.

The HP 8474 detectors are available with APC-7 (0.01-18 GHz), Type-N (0.01-18 GHz), 3.5mm (mates with SMA, 0.01-33 GHz), 2.92mm (0.01-40 GHz), or 2.4mm (0.01-50 GHz) connectors. These detectors are offered with options for optimal square-law loads (option 102) and for positive polarity output (option 103). Because the unit-to-unit frequency response tracking of these devices is typically better than  $\pm 0.3$  dB, no matched response option is offered.

### Waveguide Detectors

In addition to coaxial detectors, Hewlett-Packard offers a line of waveguide detectors that cover a portion of the millimeter frequency band. The HP Q422A (33 - 50 GHz) and HP U422A (40 - 60 GHz) are silicon, low barrier schottky diode detectors. The HP K422C (18 - 26.5 GHz) and the HP R422C (26.5 - 40 GHz) are GaAs, Planar Doped Barrier diode detectors. All four models have a negative output polarity as the standard; the HP Q422A and HP U422A are also available in a positive polarity option.

### Broadband Directional Detector

#### HP 83036C

The HP 83036C is a broadband microwave power sampler, which operates in much the same way as a directional coupler and detector combination. The HP 83036C is comprised of a resistive bridge and PDB diode, which yields a very broadband device with excellent frequency response, superior temperature response, and square law response characteristics. With a 10 MHz to 26.5 GHz frequency range, a single HP 83036C can be used in many applications where two directional couplers and detectors were once required, such as in broadband power monitoring and source leveling.

The HP 83036C has a maximum SWR of 1.7 above 50 MHz on both the input and output ports. Directivity of 14 dB matches that of most miniature couplers currently available. The maximum insertion loss is 2.2 dB.

The HP 83036C can be used as the monitoring element inside an instrument's ALC loop, the monitoring element for external leveling of a microwave source, or for forward and reverse power monitoring.

# MICROWAVE TEST ACCESSORIES

## Coaxial and Waveguide Detectors

### HP 8470 Series, 420 Series, 83036C

359

### Planar-Doped Barrier Diode Detectors (OEM Equivalent Model No.)

HP Model	Frequency Range (GHz)	Frequency Response (dB)	SWR Maximum (50Ω Nom.)	Low Level Sensitivity	Maximum Input (Peak or Average)	Short-Term Maximum Input (<1 Min.)	Option 002/102 Optimum Square-Law Load	Option 003/103 Positive Polarity Output	Other Options	Input Connector	Price
HP 8471D (HP 33331D)	0.0001-2	±0.2 to 1 GHz ±0.4 to 2 GHz	<1.23 to 1 GHz <1.46 to 2 GHz	>0.5mV/μW	100mW	0.7 Watt	Yes	Yes	Opt 175: 75 ohms	BNC(m)	\$110
HP 8471E (HP 33331E)	0.01-12	±0.23 to 4 GHz ±0.6 to 8 GHz ±0.85 to 12 GHz	<1.2 to 4 GHz <1.7 to 8 GHz <2.4 to 12 GHz	>0.4mV/μW	100mW	0.7 Watt	No	No		SMA(m)	\$155
HP 8473D (HP 33330D)	0.01-33	±0.25 to 12.4 GHz ±0.40 to 26.5 GHz ±1.25 to 33 GHz	<1.2 to 14 GHz <1.36 to 26.5 GHz <2.96 to 33 GHz	>0.4mV/μW	200mW	1 Watt	Note 2	Note 3		3.5mm(m)	\$430
HP 8473E (HP 33330E)	0.01-50	±0.25 to 12.4 GHz ±0.40 to 26.5 GHz ±0.6 to 40 GHz ±1.0 to 50 GHz	±1.4 to 26.5 GHz <1.9 to 40 GHz <2.3 to 50 GHz	>0.4mV/μW	200mW	1 Watt	Note 2	Note 3		2.4mm(f)	\$625
HP 8474A	0.01-18	±0.25 to 12.4 GHz ±0.35 to 18 GHz	<1.3 to 15 GHz <1.4 to 18 GHz	>0.4mV/μW	200mW	.75 Watt	Note 2	Note 3	Octave Bands (See Data Sheet)	APC-7	\$285
HP 8474B (HP 33334B)	0.01-18	±0.35 to 18 GHz	<1.3 to 18 GHz	>0.4mV/μW	200mW	.75 Watt	Note 2	Note 3	Octave Bands (See Data Sheet)	Type N(m)	\$285
HP 8474C (HP 33334C)	0.01-33	±0.45 to 26.5 GHz ±0.70 to 33 GHz	<1.4 to 26.5 GHz <2.2 to 33 GHz	>0.4mV/μW	200mW	.75 Watt	Note 2	Note 3	Octave Bands (See Data Sheet)	3.5mm(m)	\$265
HP 8474D (HP 33334D)	0.01-40	±0.35 to 26.5 GHz ±0.6 to 40 GHz	<1.3 to 26.5 GHz <1.8 to 40 GHz	>0.4mV/μW	200mW	.75 Watt	Note 2	Note 3	Octave Bands (See Data Sheet)	2.92m(m) (SMA Compatible)	\$385
HP 8474E (HP 33334E)	0.01-50	±0.4 to 26.5 GHz ±0.6 to 40 GHz ±1.0 to 50 GHz	<1.2 to 26.5 GHz <1.6 to 40 GHz <2.8 to 50 GHz	>0.4mV/μW	200mW	.75 Watt	Note 2	Note 3	Octave Bands (See Data Sheet)	2.4mm(m)	\$360

### Directional Detector

HP Model (OEM Equivalent No.)	Frequency Range (GHz)	Frequency Response (dB)	Input SWR Maximum (50 Nom.)	Output SWR Maximum (50 Nom.)	Maximum Thru Line Loss (dB)	Low Level Sensitivity	Minimum Directivity (dB)	Maximum Input (into 50 ohm load) With a 2:1 Source Match	Maximum Input (into Open)	Input/Output Connector	Price
HP 83036C (HP 33336C)	0.01-26.5	±1.0	1.7	1.7	2.2	18uV/μW	14	32 dBm	21 dBm	3.5mm(f)	\$785

### Low-Barrier Schottky Diode Detectors

HP Model	Frequency Range (GHz)	Frequency Response (dB)	SWR Maximum (50Ω Nom.)	Low Level Sensitivity	Maximum Input (Peak or Average)	Short-Term Maximum Input (<1 Min.)	Option 001 Matched Response	Option 002 Optimum Square-Law Load	Option 003 Positive Polarity Output	Input Flange (Equivalent Waveguide)	Price
HP 423B	0.01-12.4	±0.2/octave to 8 GHz ±0.3 overall	<1.15 to 4 GHz <1.3 to 12.4 GHz	>0.5mV/μW	200 mW	1W (Typical)	±0.2 dB to 12.4 GHz	Yes	Yes	N(m)	
HP 8470B	0.01-18	±0.2/octave to 8 GHz ±0.3 to 12.4 GHz ±0.6 to 18 GHz	<1.15 to 4 GHz <1.3 to 15 GHz <1.4 to 18 GHz	>0.5mV/μW	200 mW	1W (Typical)	±0.2 dB to 12.4 GHz ±0.3 to 18 GHz	Yes	Yes	APC-7	\$335
HP 8470B Opt 012										N(m)	\$325
HP 8472B	0.01-18	±0.2/octave to 8 GHz ±0.3 to 12.4 GHz ±0.6 to 18 GHz	<1.2 to 4.5 GHz <1.35 to 7 GHz <1.5 to 12.4 GHz <1.7 to 18 GHz	>0.5mV/μW	200 mW	1W (Typical)	±0.2 dB to 12.4 GHz ±0.3 to 18 GHz	Yes	Yes	SMA(m)	\$325
HP 8473B (33330B)	0.01-18	±0.2/octave to 8 GHz ±0.3 to 12.4 GHz ±0.6 to 18 GHz	<1.2 to 4 GHz <1.5 to 18 GHz	>0.5mV/μW	200 mW	1W (Typical)	±0.2 dB to 12.4 GHz ±0.3 to 18 GHz	No	Yes	3.5mm(m) (Mates w/SMA)	\$335
HP 8473C (33330C)	0.01-26.5	Same as 8473B to 8 GHz ±1.5 from a -3.3 dB slope from 18 to 26.5 GHz	<1.2 to 4 GHz <1.5 to 18 GHz <2.2 to 26.5 GHz	>0.5mV/μW	200 mW	1W (Typical)	±0.2 dB to 12.4 GHz ±0.3 to 18 GHz ±0.5 to 26.5 GHz	No	Yes	3.5mm(m) (Mates w/SMA)	\$360

### Waveguide Detectors

HP Model	Frequency Range (GHz)	Frequency Response (dB)	SWR Maximum (50Ω Nom.)	Low Level Sensitivity	Maximum Input (Peak or Average)	Short-Term Maximum Input (<1 Min.)	Option 001 Matched Response	Option 002 Optimum Square-Law Load	Option 003 Positive Polarity Output	Input Connector	Price
HP K422C	18-26.5 GHz	±0.6	<1.78	>0.42 mV/μW	100 mW	1W (Typical)	Note 1	Note 2	Note 3	UG-595/U MIL-W-85/1-102 (EIA WR-42) (MIL-F-3922/54C-001)	\$800
HP R422C	26.5-40 GHz	±0.6	<1.78	>0.42 mV/μW	100 mW	1W (Typical)	Note 1	Note 2	Note 3	UG-599/U MIL-W-85/3-008 (EIA WR-28) (MIL-F-3922/54-003)	\$800
HP Q422A	33-50 GHz	±1.5	<2.0	>0.25 mV/μW	100 mW	0.5W	Note 1	Note 2	Yes	UG-383/U MIL-W-85/3-010 (EIA WR-22) (MIL-F-3922/67B-006)	\$1,200
HP U422A	40-60 GHz	±1.5	<2.0	>0.20 mV/μW	100 mW	0.5W	Note 1	Note 2	Yes	UG-383/U (mod.) MIL-W-85/3-014 (EIA WR-19) (MIL-F-3922/67B-007)	\$1,500

Note 1: Not applicable for HP K422C and R422C. Available as a special option for Q/U422A. Consult an HP representative.  
 Note 2: Available as a special option on request. Consult your HP representative.  
 Note 3: Available as a special option on request. Consult your HP representative.

☎ For same-day shipment call HP DIRECT at 800-538-8787

# MICROWAVE TEST ACCESSORIES

## Modular Microcircuit Package

### HP 83040 Series

- Microcircuit design and test package
- Streamline design cycles
- Off-the-shelf delivery, convenience

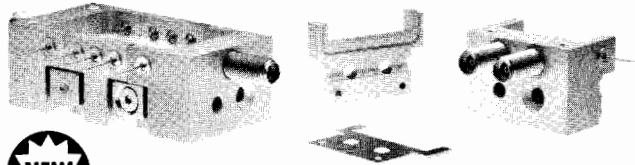

HP 83040 series

### HP 83040 Series Modular Microcircuit Package

This unique new package bridges the gap between custom model shop microcircuit packages and chip test fixtures. It offers flexibility and delivery not normally available with model shop packages, calibration methods usually associated with test fixtures, and prices to beat both. Off-the-shelf availability and modular design mean no model shop lead times or setup charges. Pre-designed launches and package parts let you spend time designing circuits.

The HP 83040 series is compatible with many of the HP vector network analyzer calibration techniques such as Adapter Swap, Adapter Removal, Port Extension, Normalization, Gating, De-embedding, and TRL, each fully described in Product Note 83040-2. Typical performance: 0.5 dB insertion loss (thru 1 launch), 20 dB return loss, 30 dB repeatability, and 40 dB source match to 26.5 GHz.

Unlike most test fixtures, this is a microcircuit package. Build circuits, test them, then seal them up for use as stand-alone components. No bulky vises or complex spring loaded pins to worry about and keep track of.

### Applications

- Breadboard design package
- Combine circuit modules; build sub-circuit libraries
- Sample test MMIC devices
- "Connectorize" chips and circuit components for use as stand-alone components in microwave chains

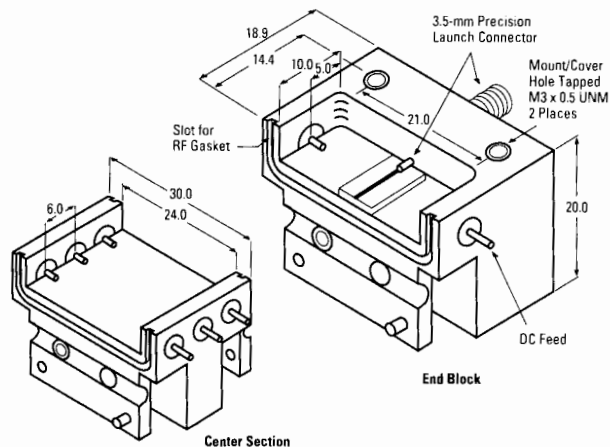

- Excellent repeatability
- Flexible modular design
- 0.635 & 0.254-mm (0.010 & 0.025-in) thick substrates

0.635-mm (0.025-in)		
Substrates	Model Number	Price
<b>Starter kit</b>	HP 83040B	\$975
<b>Evaluation kit</b>	HP 83040B Opt. 001	\$500
<b>Reorder kits</b>		
Single end blocks (w/circuit)	HP 83041B	\$375
Double end blocks	HP 83042B	\$200
Center sections		
1 of each length	HP 83043B Opt. 100	\$350
1-mm center section	HP 83043B Opt. 001	\$125
2-mm center section	HP 83043B Opt. 002	\$125
5-mm center section	HP 83043B Opt. 005	\$175
10-mm center section	HP 83043B Opt. 010	\$225
20-mm center section	HP 83043B Opt. 020	\$250
Through line circuits		
1 of each length	HP 83045B Opt. 100	\$175
1-mm through line	HP 83045B Opt. 001	\$75
2-mm through line	HP 83045B Opt. 002	\$75
5-mm through line	HP 83045B Opt. 005	\$100
10-mm through line	HP 83045B Opt. 010	\$125
20-mm through line	HP 83045B Opt. 020	\$125
Launch Circuit	HP 83046B	\$100

0.254-mm (0.010-in)		
Substrates	Model Number	Price
<b>Starter kit</b>	HP 83040C	\$1250
<b>Evaluation kit</b>	HP 83040C Opt. 001	\$500
<b>Reorder kits</b>		
Single end blocks (w/circuit)	HP 83041C	\$450
Double end blocks	HP 83042C	\$350
Center sections		
1 of each length	HP 83043C Opt. 100	\$350
1-mm center section	HP 83043C Opt. 001	\$125
2-mm center section	HP 83043C Opt. 002	\$125
5-mm center section	HP 83043C Opt. 005	\$175
10-mm center section	HP 83043C Opt. 010	\$225
20-mm center section	HP 83043C Opt. 020	\$250
Through line circuits		
1 of each length	HP 83045C Opt. 100	\$175
1-mm through line	HP 83045C Opt. 001	\$85
2-mm through line	HP 83045C Opt. 002	\$85
5-mm through line	HP 83045C Opt. 005	\$125
10-mm through line	HP 83045C Opt. 010	\$150
20-mm through line	HP 83045C Opt. 020	\$150
Launch circuit	HP 83046C	\$100

Both substrate thicknesses		
Cover	HP 83044X	\$65
Clamp kit	HP 83047X	\$65
<b>Calibration short</b>	HP 83048A Opt. 001	\$75

Starter Kit Contents		Evaluation Kit Contents	
	Quantity/Pkg	0.635-mm (0.025-in) Substrates	0.254-mm (0.010-in) Substrates
Single end blocks (with circuits)	2	2 Single launch end Blocks (with circuits)	2 Single launch end Blocks (with circuits)
Double end blocks	1	1 20-mm center section	1 10-mm center section
1-mm center section	1	1 20-mm center through line	1 10-mm center through line
2-mm center section	1	2 Clamps	2 Clamps
5-mm center section	1		
10-mm center section	1		
20-mm center section	1		
Cover	1		
1-mm through line	1		
2-mm through line	1		
5-mm through line	1		
10-mm through line	1		
20-mm through line	1		
Launch circuits	2		
Clamp kit	4		

For same day shipment, call HP DIRECT at 800-538-8787



# MICROWAVE TEST ACCESSORIES

## Coaxial and Waveguide Terminations, Coaxial Shorts & Opens

HP 908, 909, 910, 914, 920, 921, 11511, 11512, 11565, 85138, 85140/1

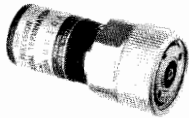

HP 909C



HP 909D



HP X910B

### HP 908A, 909A/C/D/E/F, 85138A/B Coaxial Fixed Terminations (50 and 75 Ω)

The HP 908A, 909A and 909D Terminations are low reflection loads for terminating 50 Ω coaxial systems in their characteristic impedance. The HP 909C (50 Ω) and HP 909E (75 Ω) are precision ultra low reflection terminations intended for use as calibration standards.

### HP 908A, 909A/C/D/E/F, 85138A/B Specifications

HP Model	Frequency Range (GHz)	Impedance (ohms)	SWR	Power Rating	Connector	Price
HP 908A	dc-4	50	1.05	½ W avg. 1 kW pk	N (m)	\$130
HP 909A	dc-18	50	1.05: 0-4 GHz 1.1: 4-12.4 GHz 1.25: 12.4-18 GHz	2 W avg. 300 W pk	APC-7	\$180
HP 909A Opt 012 Opt 013			1.06: 0-4 GHz 1.11: 4-12.4 GHz 1.3: 12.4-18 GHz		Opt. 012 N (m) Opt. 013 N (f)	-\$15
HP 909C	dc-2	50	1.005	½ W avg. 100 W pk	APC-7	\$310
HP 909C Opt 012 Opt 013			1.01		Opt. 012 N (m) Opt. 013 N (f)	-\$25
HP 909C Opt 200	dc-0.2	50	52 dB to 200 MHz	½ W avg. 100 W pk.	Must be ordered with Opt. 012 N (m) or Opt. 013 N(f)	\$0
HP909C Opt 201			1.01		Must be ordered with Opt. 012 N(m)	-\$20
HP 909D	dc-26.5	50	1.02: dc-3 GHz 1.036: 3-6 GHz 1.12: 6-26.5 GHz	2 W avg. 100 W pk	3.5 mm (m)	\$230
HP 909D Opt 011			1.12: 6-26.5 GHz		Opt. 011 3.5 mm (f)	\$0
HP 909D Opt 040			1.02:dc-4 GHz 1.036:4-6 GHz 1.12:6-26.5 GHz		3.5 mm (m)	+\$15
HP 909E	dc-2	75	1.01	½ W avg. 100 W pk.	N(m)	\$300
HP 909E Opt. 011					N(f)	
HP 909E Opt. 201	dc-0.2				N(m)	-\$35
HP 909F	dc-6	50	1.005:dc-5 GHz 1.01:5-6 GHz	½ W 100 W pk.	APC-7	\$325
HP 909F Opt 012	dc-6	50	1.007:dc-2 GHz 1.01:2-3 GHz 1.016:3-6 GHz	½ W 100 W pk.	N(m)	-\$25
HP 909F Opt 013					N(f)	-\$25
HP 85138A	dc-50	50	1.07: dc-26.5 GHz 1.12: 26.5-40 GHz 1.22: 40-50 GHz	½ W	2.4 mm (m)	\$475
HP 85138B					2.4 mm (f)	\$525

### HP 920C, 921A Waveguide Shorts

The HP R920C, Q920C and U920C are low-loss movable shorts for waveguide systems operating from 26.5 to 60.0 GHz.

The HP R921A, Q921A and U921A are fixed shorts for waveguide systems.

### HP 920C, 921A Specifications

HP Model	Frequency Range (GHz)	Type	Waveguide Size EIA	Price
R920C	26.5-40.0	movable	WR28	\$800
Q920C	33.0-50.0	movable	WR22	\$800
U920C	40.0-60.0	movable	WR19	\$810
R921A	26.5-40.0	fixed	WR28	\$ 85
Q921A	33.0-50.0	fixed	WR22	\$ 75
U921A	40.0-60.0	fixed	WR19	\$ 75

### HP 910A/B/C, 914B/C Waveguide Fixed and Movable Terminations

The HP 910A/B/C are fixed terminations for waveguide systems. The HP 914A/B are similar to the HP 910A/B/C, except that their absorptive elements are movable and locking plungers control the position of the elements. HP 914C models use micrometer adjustment.

### HP 910A/B/C, 914A/B/C Specifications

HP Model	Frequency Range (GHz)	SWR	Power Rating	Type	Waveguide Size (EIA)	Price
X910B	8.2-12.4	1.015	1 watt	fixed	WR90	\$375
P910A	12.4-18.0	1.02	1 watt	fixed	WR62	\$335
R910A	26.5-40.0	1.03	1 watt	fixed	WR42	\$260
Q910A	33.0-50.0	1.03	1 watt	fixed	WR22	\$275
U910A	40.0-60.0	1.04	1 watt	fixed	WR19	\$275
V910C	50.0-75.0	1.025	0.3 watt	fixed	WR15	\$650
W910C	75.0-110.0	1.03	0.2 watt	fixed	WR10	\$650
X914B	8.2-12.4	1.01	1 watt	sliding	WR90	\$775
P914A	12.4-18.0	1.01	½ watt	sliding	WR62	\$900
K914B	18.0-26.5	1.01	½ watt	sliding	WR42	\$900
R914C	26.5-40.0	1.01	½ watt	sliding	WR28	\$775
Q914C	33.0-50.0	1.01	½ watt	sliding	WR22	\$825
U914C	40.0-60.0	1.01	½ watt	sliding	WR19	\$875

### HP 11511A, 11512A, 11565A Coaxial Shorts & Opens

These shorts and opens are used for establishing measurement planes for known reflection phase and magnitude in 50 Ω and 75 Ω coaxial systems for various connectors.

### Ordering Information

Part Number	Description	Price
HP 11511A	N-(f) short (50 ohm)	\$60
HP 1250-1531	N-(f) short (75 ohm)	\$44
HP 11512A	N-(m) short (50 ohm)	\$60
HP 1250-1530	N-(m) short (75 ohm)	\$55
HP 11565A	APC-7 short (50 ohm)	\$110
HP 0960-0054	SMA-(f) short (50 ohm)	\$22.50
HP 0960-0055	SMA-(m) short (50 ohm)	\$11
HP 11652-60001	BNC (m) 50 ohm Termination	\$120
HP 85138A	2.4mm (m) 50 ohm Termination	\$475
HP 85138B	2.4mm (f) 50 ohm Termination	\$525
HP 85140A	2.4mm (m) short	\$250
HP 85140B	2.4mm (f) short	\$275
HP 85141A	2.4mm (m) open	\$275
HP 85141B	2.4mm (f) open	\$300

For same-day shipment, call HP DIRECT at 800-538-8787.

# MICROWAVE TEST ACCESSORIES

Coaxial Single-and Dual-Directional Couplers, 90° Hybrid Coupler

HP 770 Series, 11691D, 11692D, 87300 B/C, 87301D, 87310B

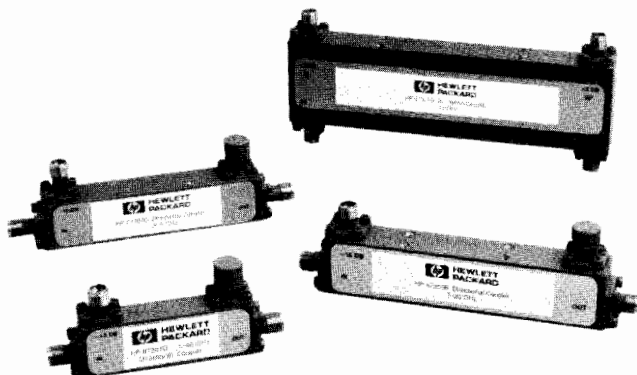

HP 87300B, 87301D, 87310B

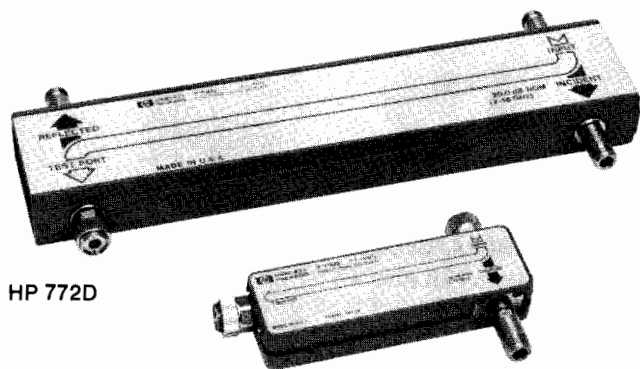

HP 772D

HP 773D

## HP 87300 Series Directional Couplers

Hewlett-Packard offers a line of compact, broadband directional and hybrid couplers that are designed for signal monitoring or, when combined with a coaxial detector, signal leveling. The HP 87300B is supplied with SMA (f) connectors, the HP 87300C had 3.5 mm (f) connectors, the HP 87301D has 2.4 mm (f) standard or optional 2.92 mm (f) connectors.

The HP 87310B is a 3 dB hybrid coupler intended for applications requiring a phase difference of 90 degrees between signals. The HP 87310B features SMA (f) connectors.

## HP 87300 Series Specifications

HP Model	Frequency Range (GHz)	Nominal Coupling & (dB) Variation	Minimum Directivity (dB)	SWR Maximum	Insertion Loss (dB)	Price
HP 87300B	1-20	10±.5	16	1.35	<1.4	\$475
HP 87300C	1-26.5	10±1	1-12.4:14 12.4-26.5:12	1-12.4:1.35 12.4-26.5:1.50	1-12.4:<1.1 12.4-26.5:<1.6	\$825
HP 87301D	1-40	13±1	1-20:14 20-40:10	1-20:1.5 20-40:1.7	1-20:<1.1 20-40:<1.8	\$1,200
HP87310B	1-18	3 dB ±.5		1.35	<1.8	\$985

## HP 773D Directional Coupler & HP 772D Dual-Directional Coupler

The HP 772D and 773D are high-performance couplers designed for broadband swept measurements in the 2 to 18 GHz range. The HP 773D is ideal for leveling broadband sources when used with an HP 8474B detector. (See also the HP 83036C directional detector). For reflectometer applications, the HP 772D is the best coupler to use with HP power sensors and power meters (such as the HP 438A dual power meter). Forward and reverse power measurements on transmitters, components, or other broadband systems are made simpler by using the HP 772D. The broadband design allows using a single test setup and calibration for tests spanning the entire 2 to 18 GHz frequency range.

## HP 774D - 778D Dual-Directional Couplers

The economical HP 774D-778D couplers cover frequency spreads of more than 2:1, each centered on one of the important VHF/UHF bands. With their high directivity and mean coupling accuracy of ±0.5 dB, these are ideal couplers in reflectometer applications. The close tracking of the auxiliary arms make these couplers particularly useful for reflectometers driven by sweep oscillators such as the HP 8350B with its appropriate plug-in. Power ratings are 50 W average, 10 KW peak.

## HP 772-779D, 11691D, 11692D Specifications

HP Model	Frequency Range (GHz)	Nominal Coupling (dB)	Maximum Coupling Variation (dB)	Minimum Directivity (dB)	SWR Primary Line Maximum (50Ω Norm.)
HP 772D	2-18	20	±0.9	2-12.4: 30 12.4-18: 27	2-12.4: 1.3 12.4-18: 1.4
HP 773D	2-18	20	±0.9	2-12.4: 30 12.4-18: 27	1.2*
HP 774D	0.215-0.450	20	±1	40	1.15
HP 775D <sup>1</sup>	0.450-0.940	20	±1	40	1.15
HP 776D <sup>1</sup>	0.940-1.90	20	±1	40	1.15
HP 777D	1.90-4.0	20	±0.4	30	1.2
HP 778D	0.10-2.0	20	±1.5	0.1-1 GHz: 36 <sup>2</sup> 1-2 GHz: 32	1.1
HP 779D	1.7-12.4	20 ± 0.5	±0.75	1.7-4 GHz: 30 4-12.4 GHz: 26	1.2*
HP 11691D	2-18	22	±1.0	2-8 GHz: 30 dB 8-18 GHz: 26 dB	1.2*
HP 11692D	2-18	22	±1 incident to test port	2-8 GHz: 30 8-18 GHz: 26 <sup>3</sup>	2-12.4 GHz: 1.3 12.4-18 GHz: 1.4

<b>HP 772D</b> Standard Connectors Primary Line: APC-7, APC-7; Auxiliary Arms: N(f) Opt 001 Primary Line, N(f), N(f)
<b>HP 774D-777D</b> Standard connectors Primary Line: N(m), N(f) Auxiliary Arm: N(f), N(f)
<b>HP 778D</b> Standard connectors Primary Line: N(m), N(f); Auxiliary Arms: N(f), N(f) Opt 011 Primary Line, APC-7, N(f) Opt 012 Primary Line, N(m), N(f)
<b>HP 779D</b> Standard connectors Primary Line N(m) input, N(f) output; auxiliary arm N(f) Opt 010 Primary Line N(f) input, N(m) output; auxiliary output N(f) Other options: APC-7 on any or all ports
<b>HP 11691D and 773D</b> Standard connectors Primary line: APC-7, APC-7; Auxiliary Arm: N(f) Opt 001 All N(f) Opt 005 (11691D only) All APC-7
<b>HP 11692D</b> Standard connectors Primary line: N(f), APC-7; Auxiliary Arms: N(f), N(f) Opt 001 Primary Line, N(f), N(f) Opt 002 Primary Line, N(f), N(m)

<sup>1</sup>Maximum auxiliary arm tracking: 0.3 dB for HP 776D; 0.5 dB for HP 777D

<sup>2</sup>30 dB, 0.1 to 2 GHz, input port.

<sup>3</sup>24 dB with Type N connector on the test port.

\*Apparent SWR at the output port of a coupler when used in a closed-loop leveling system.

# MICROWAVE TEST ACCESSORIES

## Frequency Meters, Isolators and Waveguide Directional Couplers

HP 365 Series, 532 Series, 537A, 752 Series

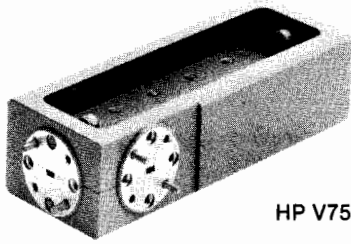

HP V752A

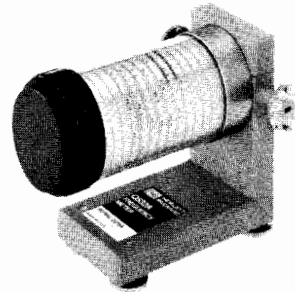

HP Q532A

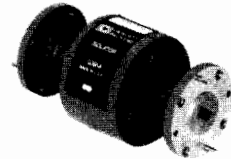

HP Q365A

### HP 752 Series Waveguide Directional Couplers

The HP 752 series Couplers are specified to meet a wide variety of microwave applications. Every coupler has a minimum directivity of 30 dB over its entire frequency range. Each coupler is swept-frequency tested to ensure that the main guide SWR and directivity specifications are accurate. Performance characteristics are unaffected by humidity, temperature, and time, making these units especially useful in microwave "standards" measurements.

The HP R752AS/CS/DS, Q/U752A/C/D, and V/W752C/D use a split block design, allowing for very close control of critical dimensions, which results in the high performance of these couplers.

The HP 752 Couplers are an essential part of many waveguide measurement systems. Attenuation measurements, reflectometer set-ups, power measurements, source leveling and network analysis are just a few areas in which these couplers are used.

### HP 752 Series Specifications

HP Model	Frequency Range (GHz)	Nominal Coupling (dB)	Mean Coupling Accuracy (dB)	Maximum Coupling Variation (dB)	Minimum Directivity (dB)	Waveguide & Flange	Price
X752A	8.2-12.4	3	±0.4	±0.6	40	WR90 UG-135/U	\$925
X752C		10					
X752D		20					
P752A	12.4-18.0	3	±0.4	±0.5	40	WR62 UG-419/U	\$885
P752C		10					
P752D		20					
K752A	18.0-26.5	3	±0.7	±0.5	40	WR42 UG-595/U	\$1295
K752C		10					\$1200
K752D		20					\$1300
R752A	26.5-40.0	3	±0.7	±0.6	40	WR28 UG-599/U	\$1400
R752C		10					
R752D		20					
R752AS	26.5-40.0	3	±0.7	±0.6	40	WR28 UG-599/U	\$915
R752CS		10					
R752DS		20					
Q752A	33.0-50.0	3	±0.7	±0.7	36	WR-22 UG-383/U	\$935
Q752C		10					
Q752D		20					
U752A	40.0-60.0	3	±0.7	±0.7	36	WR-19 UG-383/U (Mod.)	\$955
U752C		10					
U752D		20					
V752C	50.0-75.0	10	±0.7	±0.7	36	WR 15 UG-385/U	\$975
V752D		20					
W752C	75.0-110.0	10	±0.7	±0.7	33	WR 10 UG-387/U (Mod.)	\$995
W752D		20					

### HP 365A Millimetre-Wave Waveguide Isolators

The HP Q and U365A Isolators use a Faraday-rotation-type design consisting of a section of waveguide containing low-loss ferrite material and impedance matching elements. A permanent magnet supplies the external magnetic bias field to the ferrite core. This results in excellent broadband isolation ratios of at least 25 dB along with low SWR and insertion loss.

### HP 365A Waveguide Isolator Specifications

HP Model	Frequency Range (GHz)	SWR (Max.)	Maximum Insertion Loss (dB)	Minimum Isolation (dB)	Maximum Input Power (Avg)	Waveguide & Equivalent Flange	Price
R365A	26.5-40.0	1.4	1.5	25	1.5W	WR-28 UG-599/U	\$900
Q365A	33-50	1.4	1.5			WR-22 UG-383/U	\$1090
U365A	40-60	1.4	1.8			WR-19 UG-383/U (Mod)	\$1275
V365A	50-75	2.0	3.0			WR-15 UG-381/U	\$1575
W365A	75-110	2.0	3.0			WR-10 UG-387/U (Mod)	\$2000

### HP 532 Series, 537A Frequency Meters

These direct-reading frequency meters measure frequencies from 33.0 to 60.0 GHz in waveguide and from 3.7 to 12.4 GHz in coax quickly and accurately. Their long scales and numerous calibration marks provide high resolution which is particularly useful when measuring frequency differences or small frequency changes. Frequency is read directly in GHz so neither interpolation nor charts are required.

The instruments comprise a special transmission section with a high-Q resonant cavity which is tuned by a choke plunger. A 1 dB or greater dip in output indicates resonance; virtually full power is transmitted off resonance. Overall accuracy of each frequency meter includes allowance for 0 to 100 percent relative humidity and temperature variation from 13 to 33°C.

### HP 532 Series, 537A Specifications

HP Model	Frequency Range (GHz)	Overall Accuracy (%)	Calibration Increment (MHz)	W/G-Coax Equivalent Flange (Connector)	Price
537A	3.7-12.4	0.170	10	Coax Type N(f)	\$2195
Q532A	33.0-50.0	0.12	20	WR-22 UG-383/U	\$2525
U532A	40.0-60.0	0.15		WR-19 UG-383/U (Mod.)	\$2658

# MICROWAVE TEST ACCESSORIES

## Waveguide Variable, Fixed Attenuators, Stands, Filters

### HP 382 Series, 362 Series, 370 Series, 11540 Series, 373 Series

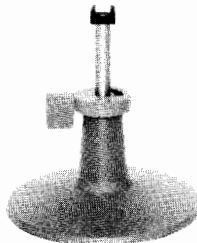

HP Q382A

HP 11540A  
HP 11548A

HP X362A

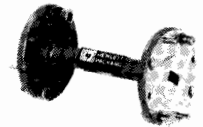

HP Q370A

### HP 382 Series Waveguide Attenuators

Operation of these HP 382 series rotary-vane, continuously-variable attenuators depends on a mathematical law rather than on the resistivity of the attenuator card. They are direct-reading and provide accurate attenuation from 0 to 50 dB regardless of temperature and humidity.

#### HP 382 Series Specifications

HP Model	Frequency Range (GHz)	Accuracy	Attenuation Range (dB)	Waveguide & Equivalent Flange	Price
X382A	8.2-12.4	±2% of reading or 0.1 dB whichever greater	0-50	WR 90 UG-135/U	\$2895
P382A	12.4-18.0	±2% of reading or 0.1 dB whichever greater	0-50	WR 62 UG-419/U	\$2925
K382A	18.0-26.5	±2% of reading or 0.1 dB whichever greater	0-50	WR 42 UG-597/U	\$3925
R382A	26.5-40.0	±2% of reading or 0.1 dB whichever greater	0-50	WR 28 UG-599/U	\$3500
Q382A	33.0-50.0	±2% of reading or 0.1 dB (whichever greater)	0-50	WR-22 UG-383/U	\$2100
U382A	40.0-60.0			WR-19 UG-383/U (Mod.)	\$2150

### HP 11540 Series Waveguide Stand, Waveguide Holders

The HP 11540A Waveguide Stand locks HP waveguide holders at any height from 70 to 133 mm (2.75 in. to 5.25 in.). The waveguide holders are offered in five sizes to hold waveguide covering frequencies from 22 to 40 GHz.

#### Ordering Information

**HP 11540A** Waveguide stand **Price** \$80  
**HP 11545A** X-Band, **11548A** R-Band Waveguide holders each \$75  
**HP 11546A** P-Band, **11547A** K-Band, Waveguide holders each \$75

### HP 362 Series Waveguide Low Pass Filters

These Hewlett-Packard low-pass filters facilitate microwave measurements by eliminating undesirable signals (such as harmonics) from the measurement system. Suppression of such signals is particularly important in applications such as broadband reflection and transmission measurements or slotted line measurements where harmonics generated by the signal source could otherwise impair measurement accuracy.

#### HP 362 Series Waveguide Low Pass Filter Specifications

HP Model	Passband (GHz)	Stopband (GHz)	Passband Insertion Loss	Stopband Rejection	SWR Maximum	Waveguide Size	Equivalent Flange	Length mm (in)	Shipping Weight kg (lb)	Price
X362A	8.2-12.4	16-37.5	<1 dB	At least 40dB	1.5	WR 90	UG-39/U	136 (5.4)	0.9 (2)	\$1400
P362A	12.4-18.0	23-54			1.5	WR 62	UG-419/U	94 (3.7)	0.37 (13 oz)	\$1395
K362A <sup>1</sup>	18.0-26.5	31-80			1.5	WR 42	UG-595/U	64 (2.5)	0.15 (5.3 oz)	\$1450
R362A <sup>1</sup>	26.5-40.0	47-120	<1 dB	>35 dB	1.7	WR 28	UG-599/U	42 (1.7)	0.11 (4 oz)	\$1500
										\$325
For R-Band, specify HP 11516A (UG-381/U).										\$350

<sup>1</sup>Circular Flange Adapters: For K-Band, specify HP 11515A (UG-425/U).

For R-Band, specify HP 11516A (UG-381/U).

### HP 370A/B/C Millimeter-Wave Fixed Attenuators

The HP Q and U 370 Fixed Attenuators offer precise attenuation, flat frequency response, and low SWR. Their ruggedness, reliability, and small size make them ideal for bench systems applications. They are also useful for general-purpose applications, such as reduction of power levels to sensitive components and systems.

#### HP 370A/B/C Fixed Attenuator Specifications

HP Model	Frequency Range (GHz)	SWR (Max)	Max. Input Power	Attenuation	Attenuation Accuracy	Waveguide & Equivalent Flange	Price
Q370A	33-50	1.2	.5W Avg.	3dB	±0.3dB	WR-22	\$550
Q370B			100W Peak	6dB	±0.6dB	UG-383/U	
Q370C				10dB	±0.3dB		
U370A	40-60	1.2	.5W Avg.	3dB	±0.3dB	WR-19	\$575
U370B			100W Peak	6dB	±0.6dB	UG-383/U (Mod.)	
U370C				10dB	±0.6dB		

### HP 373D/G Millimeter-Wave Fixed Attenuators

The HP R, Q, U, V, and W 373 Precision Fixed Attenuators offer very precise attenuation, flat frequency response, very low SWR, and low attenuation drift with age. The split block design offers this excellent performance in a rugged, reliable package. Intended for use on the bench in applications requiring very precise signal reduction, or where a precise attenuation standard is needed. Available in 20 and 50 dB values.

#### HP 373D/G Fixed Attenuator Specifications

HP Model	Frequency Range (GHz)	SWR (Max)	Max. Input Power	Attenuation	Attenuation Accuracy	Attenuation Variation	Waveguide & Equivalent Flange	Price
R373D	26.5-40	1.05	.5W Avg.	20dB	±.7dB	±.7dB	WR28	\$700
R373G			100W Peak	50dB		UG-599/U		
Q373D	33-50	1.05	.5W Avg.	20dB	±.7dB	±.7dB	WR22	\$700
Q373G			100W Peak	50dB		UG-383/U		
U373D	40-60	1.05	.5W Avg.	20dB	±.7dB	±.7dB	WR19	\$750
U373G			100W Peak	50dB		UG-383/U(mod)		
V373D	50-75	1.08	.3W Avg.	20dB	±1.0dB	±.7dB	WR15	\$750
V373G			60W Peak	50dB		UG-385/U		
W373D	75-110	1.08	.2W Avg.	20dB	±1.0dB	±.7dB	WR18	\$750
W373G			40W Avg.	50dB		UG-387/U(mod)		

# MICROWAVE TEST ACCESSORIES

Adapters, Bends, Twists, Straights, Mismatches

HP 281A/B/C, 292A/B, 11515/16A, 897A/B, 898A/B, 899A/B

365

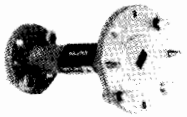

HP UV292A

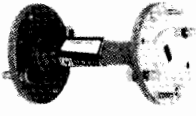

HP Q898A



HP Q899A

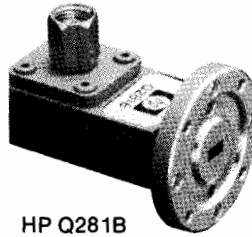

HP Q281B



HP Q897A



HP U896D



## HP 281A/B/C, 292A/B, 11515A/16A Coax and Waveguide Adapters

HP 281A/B/C rugged waveguide-to-coax adapters cover frequencies from 2.6 GHz to 60 GHz. Coaxial connector types include Type N, APC-7, 3.5 mm, 2.4 mm, and 1.85 mm.

HP 292A/B waveguide-to-waveguide adapters connect waveguide sizes with overlapping frequency ranges.

HP 11515A/16A adapt circular waveguide flanges to rectangular flanges in K-band and R-band.

### HP 281A/B/C Specifications

HP Model	SWR	Frequency Range (GHz)	Waveguide Size EIA	Coaxial Connector	W/G Flange UG(-) U	Price
S281A	1.25	2.60-3.95	WR284	N (f)	584	\$395
G281A	1.25	3.95-5.85	WR187	N (f)	407	\$295
J281A	1.25	5.30-8.20	WR137	N (f)	441	\$295
H281A	1.25	7.05-10.0	WR112	N (f)	138	\$275
X281A	1.25	8.20-12.4	WR90	N (f)	135	\$250
X281C	1.05	8.20-12.4	WR90	APC-7	135	\$445
Option 012				N (m)		-\$15
Option 013				N (f)		-\$15
P281B	1.25	12.4-18.0	WR62	APC-7	419	\$335
Option 013				N (f)		-\$15
P281C	1.06	12.4-18.0	WR62	APC-7	419	\$460
Option 012				N (m)		-\$15
Option 013				N (f)		-\$15
K281C	1.07	18.0-26.5	WR42	APC-3.5 (f)	597	\$475
Option 012				APC-3.5 (m)		\$0
R281A	1.1	26.5 - 40.0	WR-28	2.4 mm (f)	599	\$850
R281B				2.4 mm (m)		\$800
Q281A	1.1	33.0 - 50.0	WR-22	2.4 mm (f)	383	\$850
Q281B				2.4 mm (m)		\$800
U281A	1.25	40.0-60.0	WR-19	1.85 (f)	UG383/U	\$1000
U281B	1.25	40.0-60.0		1.85 (m)	Mod.	

### HP 292A/B, 11515A, 11516A Specifications

HP Model	Frequency Range (GHz)	SWR	W/G Size Flange	to	W/G Size Flange	Price
HX292B	8.2-10.0	1.05	WR 112 UG-51/U		WR 90 UG-39/U	\$275
MX292B	10.0-12.4	1.05	WR 75 Cover		WR 90 UG-39/U	\$345
MP292B	12.4-15.0	1.05	WR 75 Cover		WR 62 UG-419/U	\$275
NP292A	15.0-18.0	1.05	WR 51 Cover		WR 62 UG-419/U	\$275
NK292A	18.0-22.0	1.05	WR 51 Cover		WR 42 UG-595/U	\$275
RQ292A	33.0-40.0	1.15	WR-28 UG-381/U		WR-22 UG-383/U	\$470
QU292A	40.0-50.0	1.15	WR-22 UG-383/U		WR-19 UG-383/U(Mod.)	\$500
UV292A	50.0-60.0	1.15	WR-19 UG-383/U(Mod.)		WR-15 UG-385/U	\$490
11515A	18.0-26.5	-	WR 42 UG-425/U		WR 42 UG-595/U	\$250
11516A	26.5-40.0	-	WR 28 UG-381/U		WR 28 UG-599/U	\$250

## HP 894, 896, 897, 898, 899 Millimetre-Wave Waveguide Accessories

Waveguide accessories, such as E- & H-Plane bends, twists, and straight sections, are necessary and useful for assembling waveguide measurement systems.

HP offers HP R/Q/U/V/W 897A/B E-Plane and H-Plane bends of 90 degrees. HP R/Q/U/V/W 898A/B twists can be specified for either right rotation (A-Model) or left rotation (B-Model) of 90 degrees. And, finally, several HP R/Q/U/V/W 899A/B straight sections are available in 2.5 and 5.0 cm lengths to fill out the proper dimensions of complicated test set-ups.

Network analysis calibration is verified by measuring a precise and traceable reference impedance. HP's R/Q/U/V/W 896 standard sections and R/Q/U/V/W 894 standard mismatches are this kind of references.

They have very low SWR, less than 1.016. Impedance is NIST traceable using laser interferometry to accurately measure waveguide dimensions.

The HP Q/U896 have a unique precision flange design. When mating with a standard MIL-spec flange, this design improves repeatability by about a factor of two (when mating two HP precision flanges, repeatability is improved by a factor of five).

### HP 897A/B, 898A/B, 899A/B Waveguide Accessories Specifications

Frequency Range (GHz)	Description and HP Model	SWR	W/G	Equiv. Flange	Price
Bends					
33 - 50	H-Plane Q897A	1.1	WR-22	UG-383/U	\$180
40 - 60	E-Plane Q897B	1.1	WR-19	UG-383/U(mod)	\$195
Twists					
33 - 50	90° R.H. Q898A	1.1	WR-22	UG-383/U	\$200
40 - 60	90° L.H. U898A	1.1	WR-19	UG-383/U(mod)	\$185
50 - 75	U898A	1.1	WR-15	UG-385/U	\$175
75 - 110	W898A	1.15	WR-10	UG-387/U(mod)	\$175
Straights					
26.5 - 40	2.5cm R896B	1.016	WR-28	UG-599/U	\$485
	5cm R896D	1.016	WR-28	UG-599/U	\$550
	10cm Q899A	1.1	WR-22	UG-383/U	\$175
33 - 50	Q899B	1.016	WR-22	UG-383/U	\$526
	Q896B	1.016	WR-22	UG-383/U	\$510
	Q896D	1.016	WR-22	UG-383/U(mod)	\$185
40 - 60	U899A	1.1	WR-19	UG-383/U(mod)	\$530
	U896B	1.016	WR-19	UG-383/U(mod)	\$530
	U896B	1.02	WR-15	UG-385/U	\$610
50 - 75	W896B	1.03	WR-10	UG-387/U(mod)	\$640
Mismatches					
26.5 - 40	5cm R894D	.25	WR-28	UG-599/U	\$500
33 - 50	10cm Q894D	.25	WR-22	UG-383/U	\$510
40 - 60	U894D	.25	WR-19	UG-383/U(Mod)	\$530
50 - 75	V894B	.25	WR-15	UG-385/U	\$610
75 - 110	W894B	.25	WR-10	UG-385/U(Mod)	\$640

# DIMENSIONAL MEASUREMENTS

## Laser Interferometry Measurement Systems

HP 5527B, 5528A, VMEbus, 5501A

- High accuracy and resolution
- High stability and repeatability
- Fast axis velocity

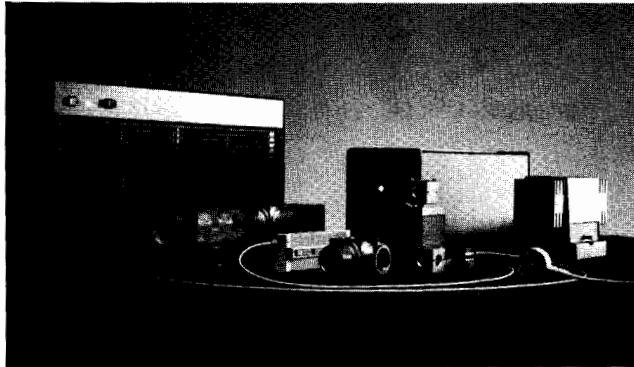

HP 5527B system with the new HP 5517C laser head, 5507B electronics, HP 10780C receiver and the 10780F remote receiver.

### Precision Positioning Products

Hewlett-Packard precision positioning systems combine Michelson interferometry with a highly stabilized, two-frequency HeNe laser to measure linear distance, pitch, roll and yaw, flatness, straightness, squareness and parallelism. These systems also have the capability to compensate for changes in the refractive index of air. The resolution is 10 nm to 2.5 nm (0.4 to 0.1 microinches). Hewlett-Packard's patented two-frequency design makes measurements over distances up to 80 meters (260 feet).

These systems offer a wide selection of measurement optics and electronics that include the new HP 10780F Remote Receiver. The high sensitivity receivers permit measurements in six degrees of freedom. Applications range from OEM precision positioning stages such as IC wafer stepper systems, IC inspection and repair systems, and flat panel systems, to optical and magnetic servo track writers, as well as precision cutting and measuring machines, to general-purpose metrology.

Each system is made up of optics, electronics and laser heads. The optics are common to all systems. The electronics of the HP 5527B, VMEbus, and HP 5501A are designed to be built into precision positioning systems.

The HP 5528A Laser Measurement System is a single axis, easy-to-use, transportable measurement system with a wide range of applications. Examples of its use are fabrication (calibration of machine tools and coordinate measuring machines), manufacturing (precision alignment and positioning), R&D (non-contact measurements), and metrology (calibration of scales, gauges and surface plates).

### System Components

HP laser transducer systems use common optics. Only the laser heads and the electronics, differ between systems. Outputs available are position, position error, A quad B, up/down pulse, and motor-drive. The technical data sheet for each system provides detailed information.

The optics and laser head for the HP 5528A are unique to that system but are compatible with the transducer system for special applications.

### Laser Heads

Four laser heads are recommended for HP transducer systems; these are the HP 5517A, HP 5517B (500 mm/second axis velocity), 5517C (700 mm/sec) and HP 5501B.

The total accuracy of a transducer system is the sum of the errors from the laser head, the choice of optics, and the effects of the environment. All HP laser heads have a vacuum wavelength accuracy of  $\pm 0.1$  ppm ( $\pm 0.02$  ppm with factory calibration to MIL-STD 45662A) and a demonstrated MTBF greater than 50,000 hours.

- Multiple optics
- Automatic compensation
- Remote sensing with fiber optics

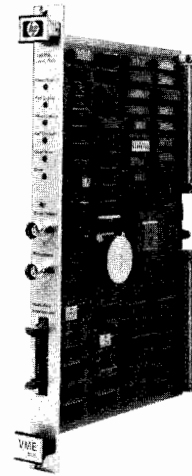

HP 10895A VME laser axis board.

### Optics

A variety of optics are available to optimize optical layout for a system. The HP 10702A Linear Interferometer is the basic measurement optic, and it is used with the HP 10703A Retroreflector. The smaller HP 10705A Single Beam Interferometer and the HP 10704A Retroreflector are used where space is limited and low mass is required.

Plane mirror interferometers are normally required for X-Y stages and offer twice the resolution, at half the axis velocity of linear and single beam interferometers. The HP 10706B High Stability Plane Mirror Interferometer is insensitive to thermal effects and thus offers excellent stability. The HP 10715A Differential Interferometer offers the highest thermal stability.

The HP 10716A High Resolution Plane Mirror interferometer offers twice the resolution (2.5nm) with half the axis velocity of the other plane mirror interferometers.

### Electronics

The electronics are the most significant differentiator of the transducer systems. Four basic outputs are available. Both open-loop measurement data and position error data for custom closed-loop positioning are available from all three transducer systems. A-quad-B with up/down pulse outputs, are available with the HP 5501A Transducer System's electronics. Closed-loop in the form of  $\pm 10$ V, PWM, and 16-bit binary, are available to drive motor amplifiers. These outputs are found on the HP 10936B Servo-Axis Board which is part of the HP 5527B Transducer System's electronics. Real-time 32-bit position output is available from the HP 10932B Axis Board - also part of the HP 5527B electronics. The new HP 10780C Receiver and the new HP 10780F Remote Receiver each work with all three systems.

### Improving Accuracy and Repeatability

Maximum accuracy and repeatability requires compensation for certain parameters. HP laser interferometer systems depend on the high accuracy of the laser's wavelength. However, the wavelength of light in air depends upon the air's refractive index, which is a function of air temperature, pressure, and composition. In addition to the wavelength of light effects, errors can result from thermal expansion of the workpiece. To take full advantage of Hewlett-Packard's high wavelength stability, the HP 10717A Wavelength Tracker compensates for changes in the air's refractive index, and the new HP 10780F Remote Receiver eliminates thermal effects due to the receiver electronics. Product Note 5527A-2, describes in detail how to achieve maximum accuracy and repeatability. Further details on the transducer systems are provided on the following pages.

- High axis velocity
- Electronic system test
- Multiple axes measurements

- Servo-loop positioning
- Multiple outputs
- Atmospheric compensation

### HP 5527B Laser Position Transducer System

The HP 5527B offers improved system performance with finer resolution, faster axis velocities, remote sensing receivers, and complete servo-control capability. It can be configured for closed or open-loop control, multi-axis capabilities, automatic compensation, and special prototyping abilities for custom electronics.

#### Electronics

The HP 5527B system electronics combine superior performance with greater ease of use and full EMC compliance. The system is controlled with HP-IB, and three outputs are available, depending on the boards used. The HP 5507B with the HP 10932B Axis Board provides open-loop measurements and position data for custom closed-loop positioning. These outputs are available in 32-bit digital format and via HP-IB. The HP 5507B with the HP 10936B Servo-Axis Board provides open-loop measurements (same as the HP 10932B Axis Board) and closed-loop outputs for various types of motor amplifiers. These closed-loop outputs are  $\pm 10V$  analog, 16-Bit digital, and pulse width modulated. The HP 10941A Prototyping Board provides the capabilities for custom electronic designs. The HP 10946C Automatic Compensation Board works with the HP 10717A Wavelength

Tracker or the HP 10751A Air Sensor and the HP 10757A Material Temperature Sensor to automatically compensate for the wavelength of light and temperature effects. The HP 10780C Receiver enables the system to have up to six measurement axes.

#### Servo Electronics

The HP 10936B Servo-Axis Board provides closed-loop outputs for precision positioning. It is a software-programmable digital servo with built-in motion control algorithms, and it allows the down-loading of custom algorithms. A built-in trace function speeds and simplifies servo loop characterization and position control unique to each system.

#### VME Electronics

The new HP 10895A Laser Axis Board, compatible with VME Rev. C.1, provides capability similar to the HP 10932B Axis Board. Outputs are position data, in 32-bit format, for closed-loop positioning systems. This VME solution permits easy, cost-effective integration of laser electronics into VMEbus systems.

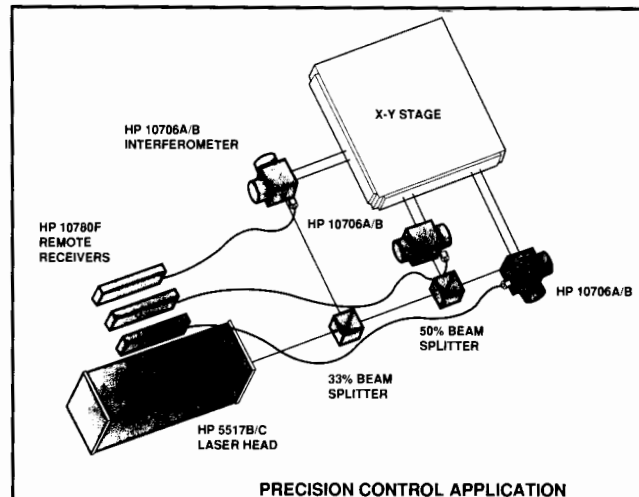
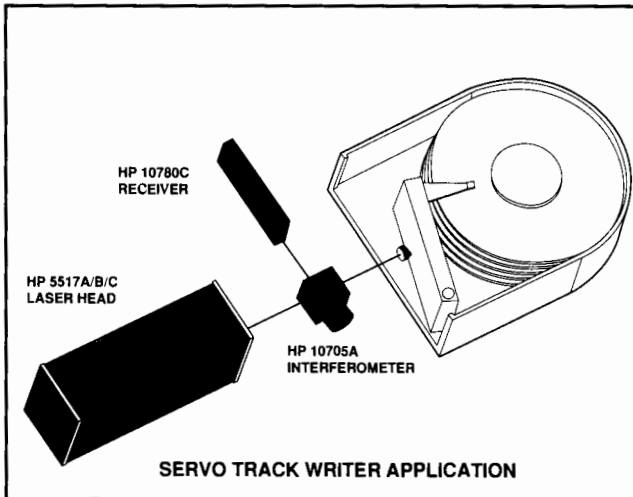

### System Specifications

	HP 5527B	VMEbus	HP 5501A
<b>Accuracy</b>			
Vacuum	0.1 ppm	0.1 ppm	0.1 ppm
With MIL STD 45662A	0.02 ppm	0.02 ppm	0.02 ppm
<b>Maximum Resolution</b>			
Linear optics	10 nm	10 nm	10 nm
Plane mirror optics	5 nm	5 nm	5 nm
High resol. optics	2.5 nm	2.5 nm	2.5 nm
<b>Maximum Axis Velocity</b>			
Linear optics	700 mm/s	700 mm/s	500 mm/s
Plane mirror optics	350 mm/s	350 mm/s	250 mm/s
High resol. optics	175 mm/s	175 mm/s	125 mm/s
<b>Maximum Range</b>	40 m	40 m	40 m
<b>Maximum Data Output Rates</b>			
Position/position error	3.3 MHz	3.3 MHz	300 KHz
A quad B	(Available late 91)	N/A	1.6 MHz
Up/down pulse	(Available late 91)	N/A	22.5 MHz
Motor-drive	8 KHz	N/A	N/A

# DIMENSIONAL MEASUREMENTS

## Laser Interferometry Measurement Systems (cont'd)

Ordering Information System Component	5527B	VMEbus	Price	Ordering Information System Component	5527B	VMEbus	Price
<b>Laser Heads</b>				<b>Compensation</b>			
HP 5517A Laser Head	X	X	\$6700	HP 10724A Plane Mirror Reflector	X	X	\$575
HP 5517B Laser Head	X	X	\$6630	HP 10751A Air Sensor - 5m cable, 1 per system	X		\$4400
HP 5517C	X	X	\$6950	HP 10751B Air Sensor - 15m cable	X		\$4500
HP 5501B Laser Head (HP 5501A System)			\$6630	HP 10757A Material Temp. Sensor, 5m cable, 2 per system	X		\$970
<b>Electronics</b>				HP 10757B Material Temp. Sensor, 10m cable	X		\$1020
HP 5507B Transducer Electronics	X		\$4400	HP 10757C Material Temp. Sensor, 20m cable	X		\$1070
Opt 032 Axis Board, 1 per axis	X		\$2040	HP 10717A Wavelength Tracker (requires HP 10780C receiver)	X		\$6730
Opt 036 Servo-Axis Board, 1 per axis	X		\$4000	HP 10946C Automatic Compensation Board	X		\$2240
Opt 046 Automatic Compensation Board	X		\$1840	<b>Cabling</b>			
HP 10932B Axis Board, 1 per axis	X		\$2450	HP 10790A Receiver Cable 3m cable, 1 per rcvr	X	X	\$130
HP 10936B Servo-Axis Board, 1 per axis	X		\$4200	HP 10790B Receiver Cable 10m cable	X	X	\$160
HP 10941A Prototyping Kit Board	X		\$500	HP 10790C Receiver Cable 20m cable	X	X	\$210
HP 10895A Laser Axis Board for VMEbus		X	\$2750	HP 10791A Laser Head Cable 3m cable		X	\$380
<b>Receivers</b>				HP 10791B Laser Head Cable 7m cable		X	\$420
HP 10780C High Sensitivity Receiver	X	X	\$660	HP 10791C Laser Head Cable 20m cable		X	\$510
HP 10780F Remote Receiver - 2m fiber optic cable*	X	X	\$770	HP 10793A Laser Head Cable 3m cable, 1 per sys	X	X	\$230
<b>Optics</b>				HP 10793B Laser Head Cable 10m cable	X	X	\$255
HP 10700A 33% Beam Splitter	X	X	\$610	HP 10793C Laser Head Cable 20m cable	X	X	\$360
HP 10701A 50% Beam Splitter	X	X	\$550	<b>Support Literature</b>			
HP 10702A Linear Interferometer	X	X	\$2040	HP 5527B Designer's Guide Manual			\$100
HP 10702A				HP 5501A Technical Data Sheet			\$0
Opt 001 Linear Interferometer /windows	X	X	\$2530	HP 5527B Technical Data Sheet			\$0
HP 10703A Reflector	X	X	\$610	AN 325-10 Sub-Micron Positioning with the HP 5527A/B Laser Positioning System			\$0
HP 10704A Reflector	X	X	\$610	AN 325-11 Disk Drive Servo Track Writing with Laser Interferometers			\$0
HP 10705A Single Beam Interferometer	X	X	\$2450	AN 325-12 non-contact measurements using laser interferometers			\$0
HP 10706A Plane Mirror Interferometer	X	X	\$3060	PN 5527A-1 Rapid Data Collection with the HP 5527A System			\$0
HP 10706B High Stability Plane Mirror Interferometer	X	X	\$3060	PN 5527A-2 Achieving Maximum Accuracy and Repeatability with the HP 5527A/B System			\$0
HP 10707A Beam Bender	X	X	\$450	PN 5527A/B-3 Advanced Measurement Techniques Using the HP 5527A/B System			\$0
HP 10710A Adjustable Mount	X	X	\$180	NOTE: For complete detailed system configurations use the appropriate technical data sheet for each system. For complete information on HP 5501A system, ask for technical data sheet P/N 5952-7993.			
HP 10711A Adjustable Mount	X	X	\$200	* Additional length cables are available.			
HP 10715A Differential Interferometer	X	X	\$4590				
HP 10715A							
Opt 001 Differential Interferometer turned configuration	X	X	\$4590				
HP 10716A High Resolution Interferometer	X	X	\$4500				
HP 10716A							
Opt 001 High Resolution Interferometer turned configuration	X	X	\$4500				
HP 10722A Plane Mirror Converter	X	X	\$560				
HP 10723A High Stability Plane Mirror Converter	X	X	\$700				



# DIMENSIONAL MEASUREMENTS

## Laser Interferometer Measurement Systems

HP 5528A

369

- Transportable
- Stand Alone
- Easy-to-use
- PC-compatible software

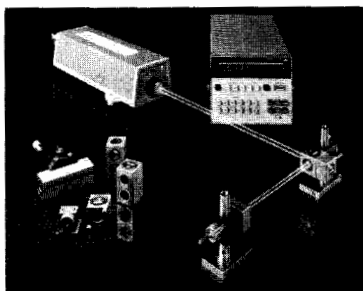

HP 5528A

- Optimized for machine tool calibration
- Acceptance testing of new machines
- Multiple measurements
- Long distance measurements



Machine tool calibration with the HP 5528A

### HP 5528A Laser Measurement System

The HP 5528A Laser Measurement System quickly detects and easily measures critical errors in positioning and geometry of precision machines. These measurements include distance and velocity, pitch and yaw, flatness, straightness, squareness and parallelism. The system can be used for machine tools, and it is also used to calibrate coordinate measuring machines, printed-circuit board fabrication equipment, and other precision equipment. Because it does not degrade from wear or aging, the HP 5528A system makes an ideal reference length standard for metrology labs and various R&D applications (non-contact measurements).

Using the HP 5528A Laser Measurement System to completely characterize machines provides the following benefits:

- ensures new machines meet their specifications
- reduces scrap, rework, and inspection cost by increasing the ability to produce repeatable accurate parts.
- reduces preventative maintenance cycles.

### Measurement Versatility Through Modular Design

Although the basic HP 5528A measures distance and velocity, additional measurement optics are available for measurement of pitch, yaw, flatness, straightness, squareness, and parallelism. The basic system consists of the HP 5508A Measurement Display, HP 5518A Laser Head, HP 10793A Laser Head Cable, and applicable measurement optics. The following measurement optic kits are available:

- HP 55280A Linear Measurement Kit (distance and velocity)
- HP 55281A Angular Optics Kit (pitch and yaw)
- HP 55282A Flatness Accessory Kit (surface plate flatness)
- HP 55283A Straightness Measurement Kit (straightness and parallelism)
- HP 10777A Optical Square (squareness)

This modular design allows the HP 5528A system to be configured to meet present needs while offering economical expansion in the future.

### Measurement and Analysis

The addition of a personal computer and metrology software greatly enhances the capabilities of the HP 5528A system. HP 10754A Dimensional Metrology Analysis Software provides complete data collection, storage, analysis, and print out for system measurements. This software operates on the HP Vectra PC family of computers and others that are compatible with the IBM PC-XT and AT.

The HP 10754A metrology software greatly increases the efficiency of machine tool calibration and other measurements with the Laser Measurement System. The time saved over manual data collection and calculation reduces machine downtime and increases productivity.

### Improved Accuracy and Repeatability

With automatic and manual compensation, the HP 5528A system provides increased measurement accuracy and repeatability. The manual compensation consists of measuring air temperature, pressure, and relative humidity, finding the compensation factor that corresponds to these measurements in a look-up table, and then entering this number into the HP 5508A measurement display. Automatic

compensation is provided by the HP 10751A Air Sensor. This device measures air temperature and pressure, calculates the compensation factor and automatically updates the HP 5508A measurement display. Automatic compensation assures maximum measurement accuracy and repeatability in changing environments.

Material temperature compensation is also available to correct for errors induced by thermal expansion of the measured object. Material temperature can be manually entered into the HP 5508A measurement display, or automatically monitored and updated by one to three HP 10757A Material Temperature Sensors.

### Specifications

#### General

- Laser:** two frequency HeNe. 1.0 mW maximum power output.
- Power:** 100, 120, 220, 240 Vac (+5%, -10%), 48-66 Hz, 175 VA maximum.
- Display update rate:** 40 Hz nominal

#### Distance

- Accuracy:**  $\pm 0.1$  parts per million (ppm) in vacuum  
 $\pm 0.02$  ppm in vacuum with factory calibration to MIL-STD 45662  
 $\pm 1.7$  ppm with HP 10751A Air Sensor (15-25 C)
- Resolution:**  $0.01 \mu\text{m}$  (1.0  $\mu\text{in.}$ )
- Measurement range:** 40m (130 ft), 80m (260 ft) with C01-5518A Long Range Special
- Measurement velocity:** 27.4 m/min (1080 in./min)

#### Pitch and Yaw

- Resolution:** 0.1 arc-sec.
- Measurement range:**  $\pm 3600^\circ$  arc-sec. ( $\pm 1^\circ$  degrees)

#### Straightness

- Resolution:**  $0.01 \mu\text{m}$  (1.0  $\mu\text{in.}$ ) using short range optics  
 $0.1 \mu\text{m}$  (10.0  $\mu\text{in.}$ ) using long range optics
- Measurement range:**  $\pm 1.5\text{mm}$  (0.060 in.)
- Axial range:** 0.1-3.0 m (0.3-10 ft) using short range optics  
1.0-30 m (3.0-100 ft) using long range optics

### Ordering Information

	Price
HP 5508A Measurement Display	\$7040
HP 5518A Laser Head	\$7040
HP C01-5518A Long Range Special	\$1500
HP 10751A Air Sensor	\$4400
HP 10753A Tripod	\$1430
HP 10754A Dimensional Metrology Analysis Software	\$1,200
HP 10757A Material Temperature Sensor	\$970
HP 10777A Optical Square	\$4500
HP 10793A Laser Head Cable	\$230
HP 55280A Linear Measurement Kit	\$4400
HP 55281A Angular Optics Kit	\$4900
HP 55282A Flatness Accessory Kit	\$2900
HP 55283A Straightness Measurement Kit	\$7400

For detailed information, ask for the following literature:

- HP 5528A Data Sheet
- HP 10754A Data Sheet
- Application Note 325-2 Machine Tool Calibration with the Laser Measurement System

# PRESSURE & TEMPERATURE

## Quartz Pressure Probe, Quartz Pressure Set, & Pressure Signal Processor

HP 2813E/D, 2816A

- 0.001 psi resolution (6,9 Pa)
- High performance

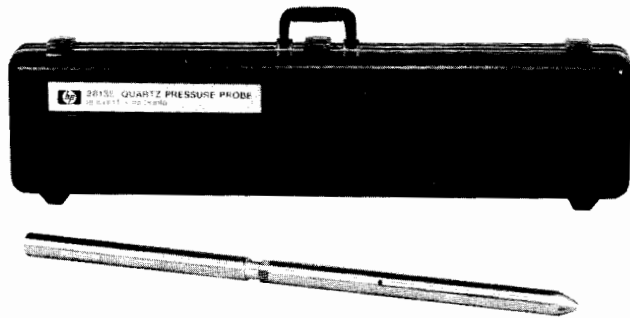

HP 2813E Quartz Pressure Probe

### HP 2813E/D Quartz Pressure Probe and Pressure Set

The quartz technology that Hewlett-Packard first introduced to the oil- and gas-well industry in 1970 is still the standard for pressure measurement applications requiring extremely high accuracy, resolution and repeatability. These features, combined with its rugged construction, make the 2813E probe ideally suited for petroleum applications, oceanographic research and subterranean hydrodynamic studies.

#### High Precision, Resolution and Repeatability

Capable of sensing wellbore pressure changes as small as 0.001 psi, the probe's measurements can be instantly observed and recorded on the surface. With an accuracy better than  $\pm 1.0$  psi plus  $\pm 0.01\%$  of the pressure reading, the HP 2813E/D gives you confidence in the precision of your measurements. Also, with a repeatability of 0.4 psi over the full calibrated pressure range (200 - 11,000 psia) at constant temperature, you can be confident that changes in successive measurements are due to changes in the well, not probe measurement error.

#### Advanced Calibration Procedures

Advanced calibration procedures also contribute to the probe's high performance, with each probe being checked at 105 discrete calibration points over its full operating pressure and temperature range. The calibration data is processed by computer to yield coefficients of an equation that describe the relationship between frequency output, applied pressure and temperature.

#### Faster Thermal Restabilization

Based on the earlier Model HP 2813B/C, the HP 2813E thermally restabilizes four to ten times faster than the HP 2813B/C. This performance, due to a redesigned mechanical package, shortens costly test time.

#### Higher Temperature Range

Improvements in the sensor crystal's processing have increased the probe's temperature range from 302° F to 350° F.

#### Rugged and Reliable

Though a precision instrument, the HP 2813E is rugged and reliable in an oil field environment. Housed in a 1 $\frac{1}{16}$  inch OD case made of Nitronic 50 stainless steel, the probe can withstand pressures of up to 12,000 psia and temperatures of up to 350° F.

#### Easy to Use and Service

The simplicity of the HP 2813E's mechanical design makes it easy to use and service in the field.

#### Quick Factory Service

Your probe receives immediate attention when we receive it. An exchange set of the reference crystal, sensor crystal and electronics pc board is available, reducing repair time to one week. Standard recalibrations and repairs take four weeks or less.

- Rugged and reliable
- Simple operation



HP 2813D Quartz Pressure Set

### Adapt to Your Own Instrumentation System

The reference crystal, sensor crystal and electronics pc board are available as matched components in the HP 2813D Quartz Pressure Set. This enables designing the essential pressure-measuring components of the HP 2813E into your own downhole instrumentation package.

#### How It Works

The essential pressure-measuring components of the HP 2813E Quartz Pressure Probe are its sensor crystal, reference crystal and electronics pc board. The sensor crystal, which is in direct fluid communication with the well, changes the frequency of its oscillations in response to pressure. The reference crystal, which is protected from applied pressure, subtracts the effects of temperature changes from the sensor crystal's frequency.

The resulting frequency is then transmitted by the electronics pc board through a center conductor, armored-electric line to the surface. A processor may be used to condition the pressure-related signal to drive a frequency counter. Or, the signal may be fed directly to a high resolution counter. The counter's signal can then be converted to a pressure reading when processed with the calibration data in a desktop computer.

The sensor crystal's high resolution is essentially constant and independent of operating pressure and temperature. Its stability minimizes hysteresis and zero drift, thus eliminating the need for frequent recalibration.

#### HP 2813E/D Specifications

##### Operating Environment

**Calibrated pressure range:** 200-11,000 psi (1,38-75,8 MPa).

**Calibrated temperature range:** 95-350° F (35-177° C).

**Static Measurement** (pressure and temperature are constant)

**Accuracy:**  $\pm [1.0$  psi (6,9 kPa) (due to curve fit error) + 0.01% of actual pressure (due to calibration system error)].

**Repeatability:**  $\pm 1.0$  psi (6,9 kPa) over the entire calibrated pressure and temperature range; or,  $\pm 0.4$  psi (2,76 kPa) over the entire calibrated pressure range with temperature held to a single value.

**Aging:** Error due to aging of sensor and reference crystal pair is typically less than  $\pm 0.5$  psi (3,45 kPa) per year.

**Temperature uncertainty error:**  $(\Delta T) * (0.28$  psi + 0.02% of actual pressure in psi) for temperature in degrees F.

**Resolution:** 0.001 psi (6,9 Pa) when sampling for 1 second.

**Sensitivity:** 1.4583 Hz/psi (15,2 Hz/kPa) nominal

##### Non-Operating Characteristics (HP 2813E)

**Outside diameter:** 1 $\frac{1}{16}$  in. (37 mm.).

**Length:** 39.3 in. (998 mm.).

**Weight:** 11 lb (5 kg).

**Static Tensile Pull Strength:** >20,000 lb (9070 kg)

**Steel Case Material:** Nitronic 50 high strength.

##### Ordering Information

HP 2813E Quartz Pressure Probe

HP 2813D Quartz Pressure Set

##### Price

\$26,400

\$20,600

# PRESSURE & TEMPERATURE

## Quartz Thermometer

### HP 2804A

371



HP 2804A

### HP 2804A Quartz Thermometer

The HP 2804A Quartz Thermometer allows you to easily measure temperature with exceptionally high accuracy and resolution. Absolute accuracy is  $\pm 40$  millidegrees Celsius over the range of  $-50^{\circ}\text{C}$  to  $150^{\circ}\text{C}$ , NIST traceable to ITS-90. The useable resolution of  $0.0001^{\circ}\text{C}$  allows you to measure temperature changes that could not be detected by other digital thermometers.

The HP 2804A can be used with one or two temperature sensing probes. The temperature of either probe, or their difference, can be measured and displayed under pushbutton control. Display resolution is selectable from 0.01 to  $0.0001^{\circ}\text{C}$  ( $0.1$  to  $0.001^{\circ}\text{F}$ ) by pushbuttons. An internal switch allows you to easily select measurement in the Celsius or Fahrenheit temperature scale.

Temperature is measured and displayed automatically with the microprocessor and electronics provided in the HP 2804A package. There is no need to balance a bridge, perform calculations using resistance- or voltage-temperature tables or curves, or to use calibration correction tables. The only adjustment necessary to remove effects of thermal history on the sensor is a simple ice point or triple point calibration adjustment using the front panel thumbwheel switches.

The HP 2804A temperature sensor is a quartz crystal whose precise angle of cut gives a stable and repeatable relationship between resonant frequency and temperature. Each quartz sensor is individually calibrated at the factory over the full temperature range. The calibration data for each sensor is processed and stored in a calibration module which is supplied with the probe.

In operation, a microprocessor in the thermometer performs the complex control and calculation operations to accurately measure temperature from the quartz sensor frequency and probe calibration information in the calibration module. The microprocessor also performs self-checks to detect fault conditions. If a problem occurs that would give an improper measurement, an error message is displayed to indicate the source of the problem.

#### HP-IB and Design

The HP-IB (standard) offers you a simple, yet flexible, way to connect the Quartz Thermometer to either an HP computing controller or printer. Temperature data can easily be sent to a computer for processing and recording. All front-panel controls can be operated automatically by commands sent on the bus.

The analog output (standard) converts any three consecutive digits to a voltage between 0 and +10 volts to drive a chart recorder. Front-panel controls allow easy adjustment of pen zero and full scale as well as normal or offset (center-zero) operation. Any three digits can be selected for conversion, allowing you to change the full scale value on the recorder.

- $\pm 0.04^{\circ}\text{C}$  absolute accuracy
- $0.0001^{\circ}\text{C}$  or  $0.001^{\circ}\text{F}$  resolution
- $-80^{\circ}$  to  $+250^{\circ}\text{C}$  range
- Display of absolute or differential temperature
- Flexible HP-IB system interface
- Variable resolution analog output
- Easy ice-point or triple-point adjustment



### HP 2804A Specifications

#### Performance

**Range:**  $-80$  to  $250^{\circ}\text{C}$ .

**Absolute accuracy:** HP 2804A with HP 18110A, or HP 18111A Quartz Probe —

$\pm 0.040^{\circ}\text{C}$  from  $-50$  to  $150^{\circ}\text{C}$

$\pm 0.075^{\circ}\text{C}$  from  $-80$  to  $250^{\circ}\text{C}$

NIST traceable to ITS-90

**Resolution:** three levels can be selected:

Level of selection	Resolution		Nominal time between readings in seconds	
	$^{\circ}\text{C}$	$^{\circ}\text{F}$	T1 or T2	T1 - T2
Low	0.01	0.1	0.1	0.2
Medium	0.001	0.01	1	2
High	0.0001	0.001	10	20

#### General

**Display:** 7-digit LED with polarity, decimal, and degree C or F annunciator.

**Probes:** laboratory probes are available for use with the HP 2804A. Refer to the data sheet for specifications and sheath configurations.

#### Power Required

100, 120, 220, or 240 Vac, +5%–10%, 48 to 66 Hz, <30 VA.

#### Ordering Information

HP 2804A Quartz Thermometer \$7,600

#### Accessories and Probes

HP 18107A External Oscillator \$780

HP 18110A Laboratory Probe and cal module, 25 mm (1 in.), \$2,600

Opt 001 Extra Prom +\$150

HP 18111A Laboratory Probe and cal module, 230 mm (9.1 in.), \$2,600

Opt 001 Extra Prom +\$150

Opt 002 Threaded Probe Connector +\$100

# SIGNAL GENERATORS

## Signal Generators to 110 GHz

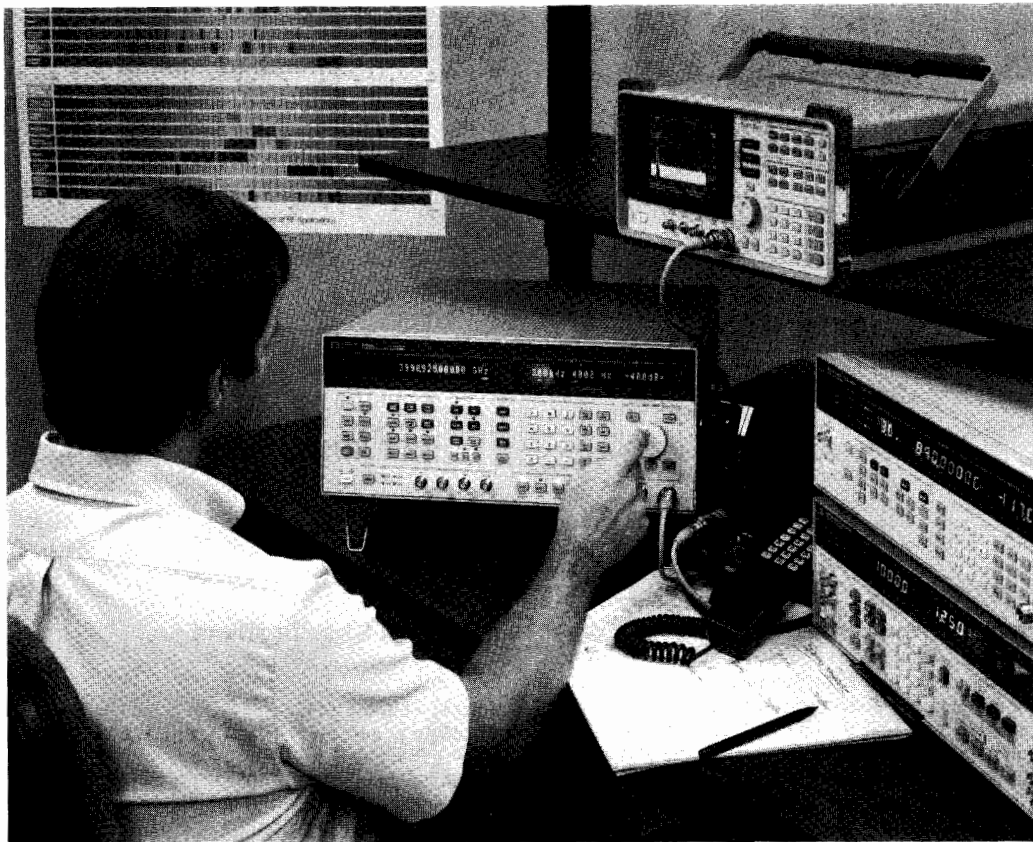

Hewlett-Packard offers the widest selection of high-performance signal sources from dc to 110 GHz. They cover every application range from low-frequency navigation signals through cellular mobile radio, to millimeter-wave satellite systems. Each offers calibrated frequency and level, and a wide range of modulation capabilities.

Signal generators can be mechanically tuned, synthesized, or digitally synthesized. Mechanically-tuned generators combine fundamental cavity-tuned oscillators with solid-state circuitry to yield spectrally pure signals with very good spurious performance and low residual FM. Collectively covering a frequency range from 10 kHz to 26.5 GHz

(and to 110 GHz with multipliers), synthesized signal generators offer programmability, high frequency stability, and accuracy. Modulation capabilities range from AM, FM,  $\phi$ M, and pulse to complex formats such as QPSK, 16-QAM and 64-QAM, up to 150 Mbaud.

### Signal Generator Summary

#### Economy RF

Frequency	Model	Characteristics	Page
0.1 to 990 MHz	HP 8656B	<b>Economically priced signal generator.</b> $\pm 1.0$ dB absolute level accuracy from +13 to -127 dBm in 0.1 dB steps. Calibrated AM and FM. Frequency resolution of 10 Hz. Time base aging rate of $\pm 2$ PPM/year.	374
0.1 to 1040 MHz	HP 8657A	<b>Spectral purity and electronic attenuator at an economical price.</b> $< -130$ dBc/Hz @ 500 MHz SSB phase noise. $< -60$ dBc spurious. Electronic attenuator. $\pm 1$ dB level accuracy. AM and FM.	376
0.1 to 2060 MHz	HP 8657B	<b>Spectral purity and pulse to 2 GHz at an economical price.</b> $< -130$ dBc/Hz @ 500 MHz SSB phase noise. $< -60$ dBc spurious. $\pm 1$ dB level accuracy. AM, FM and pulse with $> 90$ dB on/off at 1030 MHz. Opt. 022 adds 0.3 GMSK modulation	378

#### High-Performance RF

0.252 to 1030 MHz 0.252 to 2060 MHz	HP 8644A	<b>Performance signal generator for RF design.</b> $< -128$ dBc/Hz @ 1 GHz SSB phase noise ( $< -137$ dBc optional). $< -100$ dBc spurious. AM, FM, pulse modulation. Advanced modulation source. Lowest specified leakage. Avionics option available (Opt. 009).	380
0.1 to 1057.5 MHz 0.1 to 2115 MHz	HP 8642A HP 8642B	<b>Broadband spectral purity and FM for phase noise testing.</b> High spectral purity. 1 Hz frequency resolution. $\pm 1$ dB absolute output level accuracy. AM, FM, $\phi$ M and pulse. Sweep. 2-hour on-site repair.	382
0.01 to 110 MHz 1 to 1300 MHz 1 to 2600 MHz	HP 8660D	<b>Plug-in modules for high-rate/wide-deviation modulation.</b> 1 Hz frequency resolution. $3 \times 10^{-9}$ /day stability. Calibrated and leveled output from +13 to -146 dBm. HP-IB and BCD programmable. AM, FM, $\phi$ M, pulse modulation. Plug-ins determine frequency range and modulation capability.	384
0.01 to 1280 MHz	HP 8662A	<b>Low close-in noise.</b> 0.1 Hz frequency resolution, $5 \times 10^{-10}$ /day stability. Calibrated and leveled output from +13 to -140 dBm. Digital sweep. Completely HP-IB programmable. AM/FM modulation. Fast switching.	387
0.1 to 2560 MHz	HP 8663A	<b>Low close-in noise with complex modulation.</b> 0.1 Hz frequency resolution, $5 \times 10^{-10}$ /day stability. Calibrated and leveled output from +16 to -130 dBm. Digital sweep. Completely HP-IB programmable. AM, FM, $\phi$ M, pulse modulation. Fast switching.	387
0.1 to 4.2 GHz 0.1 to 6.0 GHz	HP 8665A HP 8665B	<b>Performance signal generators for 4.2 GHz and 6 GHz testing.</b> Excellent spectral purity. AM and FM. Advanced modulation source.	390

**CW Microwave**

Frequency	Model	Characteristics	Page
2 to 18 GHz	HP 8671B	<b>Precision CW signals, pure and simple.</b> 1 to 3 kHz frequency resolution, $5 \times 10^{-19}$ /day stability. +8 to -120 dBm output. Completely HP-IB programmable.	392
2 to 26 GHz	HP 8673G	<b>Digital sweep and mm wave capability add powerful flexibility in CW applications.</b> 1 to 4 kHz frequency resolution, $5 \times 10^{-19}$ /day stability, 0 to -100 dBm output (+8 dBm with Opt. 008), digital sweep, millimeter capability. Completely HP-IB programmable.	393

**Economy Microwave**

2 to 12.4 GHz 5.4 to 18 GHz	HP 8673H	<b>High-performance, multiband synthesizers for cost-sensitive applications.</b> 1 to 3 kHz frequency resolution, $5 \times 10^{-19}$ /day stability. +8 to -100 dBm output, AM, FM and pulse modulation, digital sweep, millimeter capability. Completely HP-IB programmable.	394
--------------------------------	----------	--	-----

**High-Performance Microwave**

0.01 to 50.0 GHz	HP 8360 Series	<b>Programmable, general-purpose sweeper with full network analyzer compatibility.</b> 1 Hz frequency resolution, $1 \times 10^{-9}$ /day stability. +20 to -110 dBm output. Pulse, frequency and amplitude modulation. Continuous analog sweep with spans from 100 Hz to 26.49 GHz. Completely HP-IB programmable. Complete analog, list, and step sweep capability.	395
2 to 18 GHz	HP 8673E	<b>Exceptional value in a full feature synthesizer.</b> 1 to 3 kHz frequency resolution, $1.5 \times 10^{-9}$ /day stability. +8 to -120 dBm output. Pulse, amplitude and frequency modulation. Digital sweep. Completely HP-IB programmable.	396
0.05 to 18.0 GHz 0.05 to 26.0 GHz	HP 8673C HP 8673D	<b>State of the art spectral purity for demanding applications in wideband receiver test.</b> Harmonics and sub-harmonics < -60 dBc. 1 to 3 kHz resolution, C-model; 1 to 4 kHz, D-model; +2 to -100 dBm output, C-model; +5 to -100 dBm, D-model. Pulse, amplitude and frequency modulation. Digital sweep. Completely HP-IB programmable.	396
2 to 26.0 GHz	HP 8673B	<b>Optimum choice for high performance microwave receiver and subsystem test.</b> 1 to 4 kHz frequency resolution, $5 \times 10^{-19}$ /day stability. +8 to -100 dBm output. Pulse, amplitude and frequency modulation. Digital sweep. Completely HP-IB programmable.	396
0.01 to 20 GHz	8341B Synthesized Sweeper	<b>General-purpose sweeper with full network analyzer compatibility.</b> 1-3 Hz frequency resolution, $1 \times 10^{-9}$ /day stability. +12 to -110 dBm output. Pulse, frequency and amplitude modulation. Continuous analog sweep with spans from 100 Hz to 19.99 GHz. Low harmonic option. Completely HP-IB programmable.	Contact HP
0.01 to 26.5 GHz	8340B Synthesized Sweeper	<b>General-purpose sweeper with full network analyzer compatibility.</b> 1 to 4 Hz frequency resolution, $1 \times 10^{-9}$ /day stability. +12 to -110 dBm output. Pulse, frequency and amplitude modulation. Continuous analog sweep with spans from 100Hz to 26.49 GHz. Completely HP-IB programmable.	Contact HP

**Frequency Agile/Complex Signal Simulation**

0.252 to 1030 MHz 0.252 to 2060 MHz	HP 8645A	<b>Performance signal generator for testing frequency agile radios and surveillance receivers.</b> 15 $\mu$ sec switching speed. Spectral purity. AM, FM, pulse modulation. FM deviation to 20 MHz. Flexible control of frequency.	398
dc to 50 MHz	HP 8770A/S	<b>High performance arbitrary waveform source for baseband simulation and advanced modulation.</b> Simulates highly complex baseband and modulated carriers for radar/EW, communications, disc drive, and other applications. 12-bit resolution, excellent spectral purity. 125 MHz clock rate. HP 11776A Waveform Generation Software runs on HP Technical Desktop Computer.	400
0.01 to 3 GHz (Optionally to 18 GHz)	HP 8791 Model 11	<b>Reconfigurable agile signal simulator for radar, EW and spread-spectrum simulation.</b> Advanced frequency-agile signal simulation for EW, radar and communication receiver test. 250 ns frequency hopping over 3 GHz. Arbitrary control over AM, FM, $\phi$ M, pulse modulation and agile carrier. 40 MHz modulation bandwidth. Easy-to-use application-specific instrument-on-a-disk software. Optional up-conversion available to 18 GHz.	402
0.01 to 3 GHz	HP 8780A	<b>Precision wideband analog and digital modulation source for digital microwave communications and radar.</b> Synthesized signal generator for wideband and complex modulation formats. Digital formats from BPSK to 64 QAM. Vector (quadrature) bandwidths dc to 350 MHz. +10 to -100 dBm.	404
1 to 250 MHz	HP 8782A	<b>Economy digital modulation source.</b> Synthesized signal generator for digital modulations BPSK through 256 QAM. DC to 100 MHz symbol rates. +7 to -100 dBm.	405

**Portable Cavity-Tuned Sources**

0.5 to 1024 MHz	HP 8640B	<b>High-performance RF for bench.</b> Calibrated and leveled output from +19 to -145 dBm. AM, FM and external pulse modulation. Built-in counter and phase lock capability.	406
2.3 to 6.5 GHz 5.4 to 12.5 GHz	HP 8683B HP 8684B	<b>Rugged, portable sources with high performance modulation.</b> High spectral purity, stability. $\pm 2.5$ dB absolute level accuracy from +10 to -110 dBm. AM, FM standard. High performance internal pulse modulator and pulse generator. Portable, rugged (19.1 kg).	408
2.3 to 13 GHz 5.4 to 18 GHz	HP 8683D HP 8684D	<b>Rugged, portable sources with high performance modulation and wideband frequency coverage.</b> Same as B model except with wideband frequency coverage. DC coupled FM with $\pm 10$ MHz deviations available. -3 dBm standard output power in doubled frequency band. +10 dBm available with Option 001.	408

**Millimeter Sources**

26.5 to 40 GHz 33 to 50 GHz 40 to 60 GHz 50 to 75 GHz 75 to 110 GHz	HP 83554A HP 83555A HP 83556A HP 83557A HP 83558A	<b>Efficient frequency multipliers.</b> Effectively extends the performance of an 11 to 20 GHz microwave source HP 8673B/C/D, 8340, 8341, 8350B, 8360 to the millimeter-wave frequency ranges.	421
---	---	--	-----

# SIGNAL GENERATORS

## Economy RF

### HP 8656B

- 100 kHz to 990 MHz
- $\pm 1.0$  dB absolute level accuracy
- Amplitude offset and phase adjustment capability
- 150 millisecond frequency switching time
- Versatile simultaneous modulation capabilities
- Fully HP-IB programmable

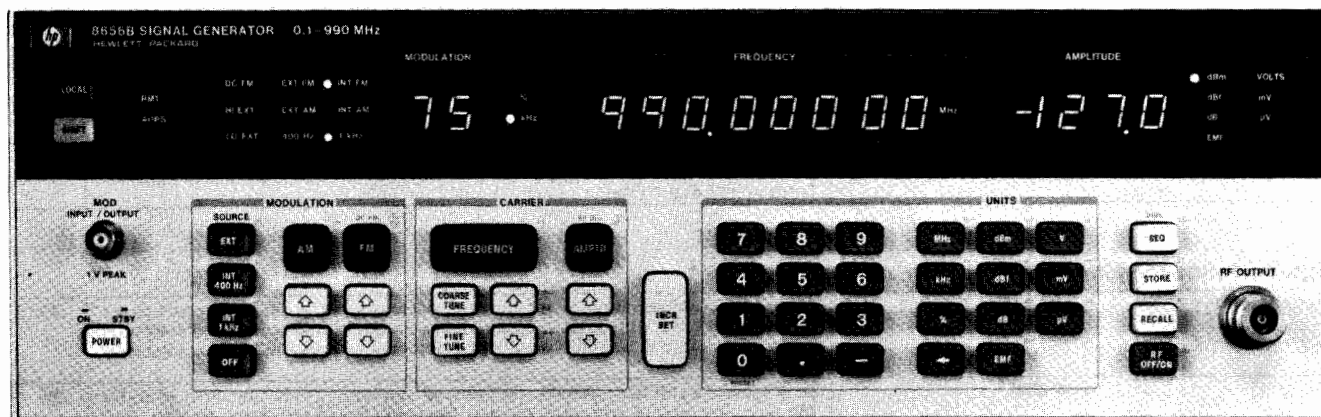

HP 8656B



### HP 8656B Synthesized Signal Generator

The HP 8656B is a programmable synthesized signal generator that offers exceptional value through a powerful combination of performance, quality and economy.

#### Communication Band Frequency Coverage

The HP 8656B provides frequency coverage from 0.1 to 990 MHz (with under-range to 10 kHz). This wide range covers the IF and LO frequencies as well as the RF frequencies of most receivers. It also allows testing in a variety of communication systems including the 800 MHz FM mobile band. Frequency resolution of 10 Hz allows convenient setting of increments including narrow channel spacings, while characterization of phase sensitive devices is made easier with the help of the phase increment/decrement feature. The standard internal reference has an aging rate of 2 ppm/year. Improved stability and accuracy can be achieved by adding the optional  $1.5 \times 10^{-7}$ /day high stability time base (Option 001) or using an external reference of 1, 5 or 10 MHz.

#### Precise Output Control

The 8656B also features  $\pm 1.0$  dB absolute level accuracy and 0.1 dB resolution for accurate receiver sensitivity tests, circuit characterization and R&D applications. The output levels are calibrated from +13 dBm (overrange to +17 dBm) to -127 dBm and may be set and displayed in any one of 14 convenient units including dBm, volts, dB $\mu$ V or Vemf. The output level can also be offset to compensate for cable and/or other losses external to the generator, or turned on or off with a dedicated key. Shielding keeps leakage at  $< 1.0 \mu$ V for testing RFI susceptible devices, and standard resettable reverse power protection for up to 25 watts guards against accidental damage from transmitters.

#### Versatile Modulation

The HP 8656B's modulation capabilities include simultaneous and mixed modulation modes (AM/AM, FM/FM and AM/FM) from internal (1 kHz and 400 Hz) and external sources. AM is ac coupled while FM can be either ac or dc coupled. The patented dc coupling technique used in the HP 8656B provides exceptional long term stability ( $< 10$  Hz/hour) and center frequency accuracy ( $\pm 500$  Hz) eliminating the need for retuning in the dc FM mode. For calibrated external modulation, a 1V peak signal is required, and HI/LO annunciators on the HP 8656B indicate when the external signal is within 5% of the correct amplitude. (For information on pulse modulation, refer to the HP 8657B Opt. H60.)

#### Ease of Operation For Improved Productivity

The HP 8656B is designed for efficient operation in a bench environment. Features such as being able to change Frequency, Modulation and Level without having to access "hidden" displays or menus will streamline your testing. Additionally, the Frequency, Modulation and Level functions each have their own UP/DOWN arrow keys for rapid front-panel setup and tuning.

Up to ten complete front-panel setups can be stored in the HP 8656B's memory for recall during testing. These setups can be accessed sequentially by pushing one front-panel key or by using the rear-panel SEQ port. (The SEQ port can be connected to a foot switch or other operator-controlled device.)

#### Programmability for High Volume Test

Full HP-IB programmability is standard with the HP 8656B. Each programming command has an easy-to-remember, two-character, alpha-numeric HP-IB code. All functions are quickly and easily programmed using the same function/data/units format used on the front panel.

Additionally, the HP 8656B program codes are 100% upwards compatible with the new HP 8657A Synthesized Signal Generator. This provides you with even more flexibility in system configuration without having to modify any program code.

## HP 8656B Specifications

### Frequency

**Range:** 100 kHz to 990 MHz (8 digit LED display).

**Frequency underrange:** 10 kHz with uncalibrated output.

**Resolution:** 10 Hz.

**Accuracy and stability:** same as internal time base.

### Typical Time Base Characteristics

Typical Characteristics	Standard Time Base	Option 001 Time Base
Aging Rate	$\pm 2$ ppm/year	$1.0 \times 10^{-9}$ /day after 45 days
Frequency	50 MHz	10 MHz
External Reference Input (rear panel)	Accepts any 1, 5, or 10 MHz ( $\pm 0.002\%$ ) frequency standard at a level $> 0.15$ Vrms into 50 ohms.	

**Frequency switching speed (to be within 100 Hz of final frequency):**  $< 150$  ms.

**Phase Offset:** adjustable via HP-IB or from the front panel in nominal 1 degree increments.

### Spectral Purity

**Spurious Signals ( $\leq +7$  dBm output levels)**

**Harmonics:**  $< -30$  dBc.

**Non-harmonic spurious (greater than 5 kHz from carrier in CW mode):**  $< -60$  dBc.

**Sub-harmonics:** none.

### Residual FM

Post Detection Noise Bandwidth	Frequency Range (MHz)			
	0.1 to 123.5	123.5 to 247	247 to 494	494 to 990
0.3 to 3 kHz	$< 7$ Hz rms	$< 2$ Hz rms	$< 4$ Hz rms	$< 7$ Hz rms
0.05 to 15 kHz	$< 15$ Hz rms	$< 4$ Hz rms	$< 8$ Hz rms	$< 15$ Hz rms

**Residual AM (0.05 to 15 kHz post detection noise bandwidth):** 0.025%.

### SSB Phase Noise (CW only)

Offset from Carrier	0.1 to 123.5 MHz (dBc/Hz)	123.5 to 247 MHz (dBc/Hz)	247 to 494 MHz (dBc/Hz)	494 to 990 MHz (dBc/Hz)
20 kHz	$< -114$	$< -126$	$< -120$	$< -114$

Typical SSB Phase Noise at 500 MHz

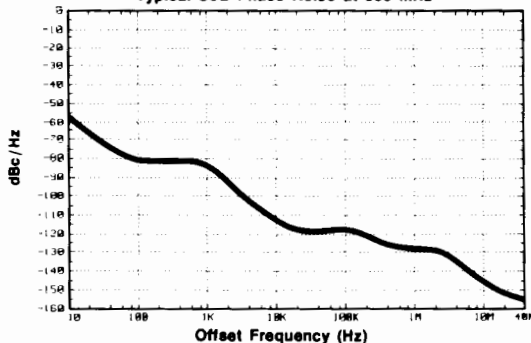

### Output

**Level range (into 50 ohms):**  $+13$  dBm to  $-127$  dBm (3 1/2 digit LED display; uncalibrated output to  $+17$  dBm).

**Resolution:** 0.1 dB.

**Absolute level accuracy:**  $\pm 1.0$  dB; 123.5 to 990 MHz  $< \pm 1.5$  dB;  $f_c < 123.5$  MHz, levels  $> +7$  dBm and  $< -124$  dBm.

**Level flatness (100 kHz to 990 MHz):**  $\pm 1.0$  dB at an output level setting of 0.0 dBm.

**Reverse power protection:** protects signal generator from application of up to 25 watts (from a 50 $\Omega$  source) of RF power to 990 MHz into generator output; dc voltage cannot exceed 25V.

### Amplitude Modulation (2 digit LED display)

**AM depth<sup>1</sup>:** 0 to 99% to  $+7$  dBm and 0 to 30% to  $+10$  dBm.

**Resolution:** 1%.

**AM rate:** internal 400 Hz and 1 kHz,  $\pm 3\%$ ; external (1 dB bandwidth), 20 Hz to 40 kHz.

**AM distortion (at internal rates):**  $< 1.5\%$ , 0-30% AM;  $< 3\%$ , 31-70% AM;  $< 4\%$ , 71-90% AM.

**Indicator accuracy (for depths  $< 90\%$  internal rates and levels  $< +7$  dBm<sup>1</sup>):**  $\leq \pm(2\% + 4\%$  of reading).

**Incidental phase modulation (at 30% AM depth and internal rates):**  $< 0.3$  radian peak.

### Frequency Modulation (2 digit LED display)

#### FM Peak Deviation

Center Frequency	Maximum Peak Deviation	
	AC Mode	DC Mode
0.1 to 123.5 MHz	The lesser of 99 kHz or 4000 x rate (Hz)	99 kHz
123.5 to 247 MHz	50 kHz or 1000 x rate (Hz)	50 kHz
247 to 494 MHz	99 kHz or 2000 x rate (Hz)	99 kHz
494 to 990 MHz	99 kHz or 4000 x rate (Hz)	99 kHz
FM not specified for $f_c - (\Delta f_{pk}) < 100$ kHz		

**Resolution:** 100 Hz for deviations less than 10 kHz; 1 kHz for deviations greater than 10 kHz.

**FM rate:** internal 400 Hz and 1 kHz,  $\pm 3\%$ ; external (1 dB BW), dc coupled, dc to 50 kHz; ac coupled, 20 Hz to 50 kHz.

**Center frequency accuracy in dc FM mode:**  $< \pm 500$  Hz.

**Center frequency stability in dc FM mode:**  $< 10$  Hz/hour.

**FM distortion (internal rates and  $\geq 3$  kHz peak deviations):**  $< 0.5\%$ .

**Indicator accuracy<sup>1</sup>:**  $\pm 5\%$  of reading at internal rates.

**Incidental AM (for center frequency  $\geq 500$  kHz, peak deviation  $< 20$  kHz and internal rates):**  $< 0.1\%$ .

### Remote Programming

**Interface:** HP-IB (Hewlett-Packard's implementation of IEEE - 488).

**HP-IB interface functions:** SH0, AH1, T0, L2, SR0, RL1, PP0, DC1, DT0, C0 and E1. (For more on these codes, refer to the HP-IB section of this catalog.)

### General

**Operating temperature range:**  $0^\circ$  to  $+55^\circ$  C.

**Leakage:** conducted and radiated interference is within the requirements of methods RE02 of MIL STD 461B, FTZ 1115. Furthermore, RF leakage of less than  $1.0 \mu\text{V}$  is induced in a two-turn loop, 2.5 cm in diameter, held 2.5 cm away from the front surface.

**Power requirements:** 100, 120, 220, or 240 Vac;  $+5\%$ ,  $-10\%$ ; 48 to 440 Hz, 125 VA maximum.

**Weight:** net, 18.2 kg (40 lb); shipping, 23.6 kg (52 lb).

**Size:** 133 H x 425 W x 520 mm D (5.25" x 16.75" x 20.5"). HP System II module size: 5/4 H x 1 MW x 17 D. For cabinet accessories, see page 714.

**Rack slides and transit case:** HP part numbers are: slide kit, 1494-0018; tilt slide kit, 08656-82001; full module transit case, 9211-2655.

### Ordering Information

**HP 8656B Signal Generator<sup>2</sup>** **Price** \$6,300

**Opt 001** High stability time base + \$950

**Opt 002** RF connectors on rear panel only + \$250

**Opt 907** Front handle kit (5061-9689) + \$57

**Opt 908** Rack flange kit (5061-9677) + \$33

**Opt 909** Rack flange kit with front handles (5061-9683) + \$82

**Opt 910** Provides an additional operation and calibration manual (08656-90204) and two service manuals (08656-90205) + \$360

**Opt 915** Add service manual (08656-90205) + \$154

**Opt W30** Extended repair service. See page 723. + \$155

**Opt W32** Calibration service. See page 723. + \$655

<sup>1</sup>AM depth and FM deviation are further limited by Indicator Accuracy specifications.

<sup>2</sup>HP-IB cables not included. For description and price, see page 579.

☎ For same-day shipment, call HP DIRECT at 800-538-8787

# SIGNAL GENERATORS

## Economy RF

### HP 8657A

- 100 kHz - 1040 MHz frequency coverage
- $-130$  dBc/Hz SSB phase noise at 20 kHz offsets
- Fully HP-IB programmable
- Solid-state output attenuator
- $\pm 1$  dB absolute level accuracy (typically  $\pm 0.5$  dB)
- Versatile, simultaneous AM/FM modulation

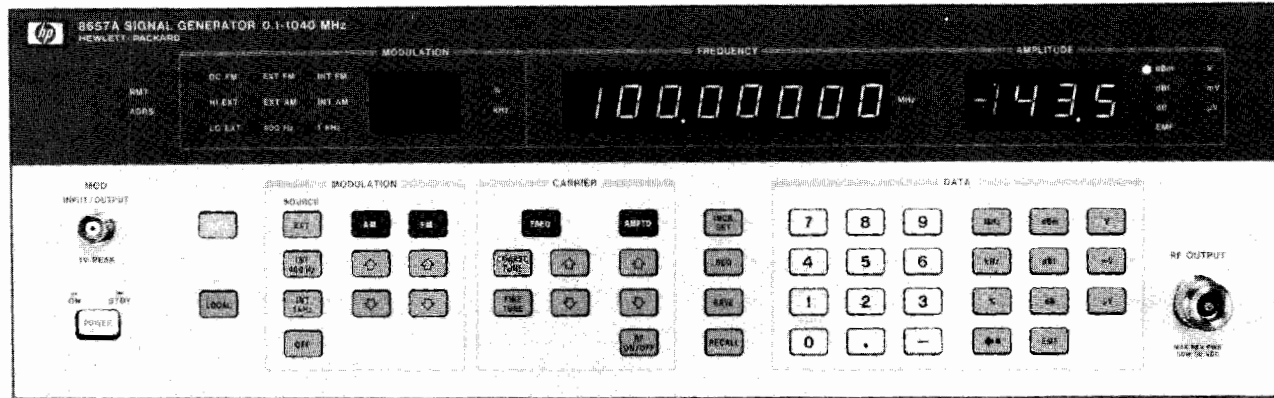

HP 8657A



Supported by  
**HP ITG**  
Software

### HP 8657A Synthesized Signal Generator

The HP 8657A is a 100 kHz to 1040 MHz synthesized signal generator that offers truly outstanding performance at an economical price. The HP 8657A gives enhanced performance above the HP 8656B signal generator to form a complementary set of low cost/high performance RF signal generators from Hewlett-Packard.

#### Spectral Purity for Demanding Applications

The HP 8657A provides excellent phase noise performance across its full 100 kHz to 1040 MHz range. When characterizing an RF receiver, the SSB phase noise of the HP 8657A ( $-130$  dBc/Hz at 500 MHz), provides the performance for almost all measurements requiring test signals at adjacent or out-of-channel offsets.

Additionally, due to a new oscillator design, the HP 8657A has a residual FM specification of  $< 4$  Hz rms (typically  $< 2$  Hz rms) when measured in a 300 Hz to 3 kHz detection bandwidth. Lower residual FM means lower measurement uncertainty in key measurements such as: distortion, signal-to-noise, and hum and noise.

#### RF Output with Electronic Attenuator

The HP 8657A has a patented, solid-state attenuator that provides accurate output levels to  $\pm 1.0$  dB (typically  $\pm 0.5$  dB). The electronic attenuator has an estimated 3 million hour MTBF (Mean Time Between Failures). The HP 8657A instrument is backed with a 5-year warranty against attenuator failure, providing you with the highest level of insurance for trouble free performance.

The HP 8657A provides high RF output power (+13 dBm with over-range to +17 dBm) for driving mixers and overcoming cable losses without the use of an external amplifier. The unique RF leveling-loop design also lowers intermodulation distortion to typically better than  $-50$  dBc. Reverse power protection is provided standard for protection up to 50 watts and 50 Vdc.

#### Versatile Modulation

The HP 8657A can combine modulation modes for AM+AM, FM+FM, and AM+FM from both internal and external modulation sources. Like the HP 8656B, the HP 8657A has ac coupled AM and ac/dc coupling for FM.

The patented dc coupling technique provides excellent long term stability ( $< 10$  Hz/hour drift) as well as center frequency accuracy ( $\pm 500$  Hz worst case). When dc FM is enabled, SSB phase noise and residual FM performance are not degraded as with other generators. DC FM can allow the HP 8657A to be used as an ideal VCO in a design application or to be used to faithfully reproduce digital squelch tones when modulating the carrier signal.

Pulse modulation is available and can be ordered under HP 8657B Option H60.

#### Designed for Ease of Operation

The HP 8657A contains many features that streamline operation in both the manual/bench or ATE environments. The easy-to-use front panel, for example, has up/down arrow keys to control frequency, amplitude, and modulation independently. Up to 100 of your front panel settings can be stored in non-volatile storage registers with recall capability through the numeric keypad or sequentially with the SEQ key. Sequencing through the storage registers can also be done by attaching a momentary contact switch to the rear panel SEQ port of the HP 8657A for remote sequence control by, for example, a foot switch.

The HP 8657A is designed for ATE applications with its  $< 135$  ms switching speed for high throughput in a production environment. Like the HP 8656B, the HP 8657A's programming codes are easy to remember (silk-screened on the front panel) and to implement.

The HP-IB program codes for the HP 8656B are 100% upwards compatible with the HP 8657A. This provides you with maximum flexibility when considering upgrading your system from the HP 8656B to the enhanced performance of the HP 8657A.

#### HP 8657A Specifications

##### Frequency

**Range (8 digit display):** 100 kHz to 1040 MHz. Underrange to 10 kHz with uncalibrated level and modulation.

**Resolution:** 10 Hz.

**Display resolution:** 10 Hz (100 Hz,  $f_c > 1000$  MHz).

**Switching speed** (to be within 100 Hz of final frequency):  $< 135$  ms.

**Accuracy and stability:** Same as time base used.

##### Typical Timebase Characteristics

	Standard	Option 001
Aging rate	$\pm 2$ ppm/year	$1.0 \times 10^{-9}$ /day after 45 days
Temperature (0-55° C)	$\pm 10$ ppm	$7 \times 10^{-9}$
Line Voltage	—	$2 \times 10^{-9}$ (+5%, -10%)
Frequency	50 MHz	10 MHz
Timebase Reference Signal (Rear Panel)	Available at a level of $> 0.15 V_{rms}$ into 50 $\Omega$ . (Output of 10, 5 or 1 MHz is selectable via internal jumper). If external reference is used, output will be the same frequency.	
External Reference Input (Rear Panel)	Accepts any 10, 5 or 1 MHz ( $\pm 0.002\%$ ) frequency standard at a level $> 0.15 V_{rms}$ into 50 $\Omega$ .	



### Spectral Purity

**Spurious Signals ( $\leq +7$  dBm Output Levels)**

**Harmonics:**  $< -30$  dBc.

**Sub-harmonics:** none.

**Non-harmonics (CW mode, 5 kHz - 2 MHz offsets):**

-60 dBc,  $f_c$ : 0.1 - 130 MHz and 520 - 1040 MHz;

-66 dBc,  $f_c$ : 260 - 520 MHz;

-72 dBc,  $f_c$ : 130 - 260 MHz.

**Residual FM (in CW mode):**

Frequency Range	Post Detection BW (rms detector)	
	300 Hz to 3 kHz	50 Hz to 15 kHz
0.1- 130 MHz	4 Hz	6 Hz
130- 260 MHz	1 Hz	1.5 Hz
260- 520 MHz	2 Hz	3 Hz
520-1040 MHz	4 Hz	6 Hz

**Residual AM (50 Hz to 15 kHz BW in CW mode):**  $< 0.04\%$  AM.

**SSB phase noise (in CW mode):**

Carrier Frequency	SSB $\phi$ -Noise 20 kHz Offset
0.1 to 130 MHz	$< -124$ dBc/Hz
130 to 260 MHz	$< -136$ dBc/Hz
260 to 520 MHz	$< -130$ dBc/Hz
520 to 1040 MHz	$< -124$ dBc/Hz

Typical HP 8657A SSB Phase-Noise at 500 MHz

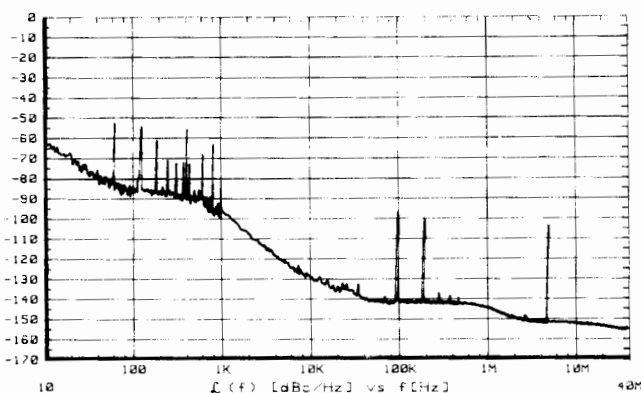

### Output

**Level range (3 1/2-digits):** +13 dBm to -143.5 dBm into 50 $\Omega$ , +10 dBm to -143.5 dBm for frequencies from 100 kHz to 1 MHz.

**Resolution:** 0.1 dB.

**Absolute level accuracy<sup>1</sup>:**  $< \pm 1.0$  dB, +7 to -127 dBm;  $\pm 1.5$  dB,  $> +7$  dBm.

**Typical absolute level accuracy:**  $< \pm 1.5$  dB, output levels  $< -127$  dBm;  $\pm 0.5$  dB, 25 $^\circ$  C  $\pm 10^\circ$  C, +7 to -127 dBm.

**Level flatness (0.1 - 1040 MHz):**  $< \pm 0.5$  dB, at 0 dBm.

**SWR ( $f_c \geq 400$  kHz):**  $< 1.5$ , level  $< -3.5$  dBm;  $< 2.0$ , level  $\leq +13$  dBm.

**Reverse power protection:** protection up to 50W from a 50 $\Omega$  source. DC voltage cannot exceed 50V.

### Amplitude Modulation

**AM depth (2-digit display):** 0 to 99%, level  $\leq +7$  dBm,  $f_c \geq 400$  kHz. 0 to 30%, level  $\leq +10$  dBm,  $f_c \geq 400$  kHz<sup>2</sup>.

**Resolution:** 1%.

**AM rate, internal:** 400 Hz and 1 kHz,  $\pm 2\%$ . External: 20 Hz to 40 kHz (1 dB bandwidth, AC coupled).

**AM distortion (at internal rates):**  $< 1.5\%$ , 0 to 30% AM;  $< 3.0\%$ , 30 to 70% AM,  $< 4.0\%$ , 70 to 90% AM.

**Indicator accuracy (for depths  $< 90\%$  and internal rates and levels  $< +7$  dBm):**  $\pm (2\% + 6\%$  of setting).

**Incidental  $\theta$ M (at 30% AM, internal rates):**  $< 0.3$  radians peak.

<sup>1</sup> Absolute level accuracy includes allowances for output linearity, temperature, flatness, attenuator accuracy and measurement error.

<sup>2</sup> 0 - 30% for  $f_c < 400$  kHz, levels  $\leq +7$  dBm.

### Frequency Modulation

**Maximum FM peak deviation (2-digit LED display):**

Center Frequency	Maximum Peak Deviation	
	AC Mode (the lesser of)	DC Mode
0.1- 130 MHz	99 kHz or 4000 $\times$ rate (Hz)	99 kHz
130- 260 MHz	50 kHz or 1000 $\times$ rate (Hz)	50 kHz
260- 520 MHz	99 kHz or 2000 $\times$ rate (Hz)	99 kHz
520-1040 MHz	99 kHz or 4000 $\times$ rate (Hz)	99 kHz

FM not specified for  $f_c - (\Delta f_{pk}) < 100$  kHz.

**Resolution:** 100 Hz, dev.  $< 10$  kHz; 1 kHz, dev.  $\geq 10$  kHz.

**FM rate:** Internal: 400 Hz and 1 kHz,  $\pm 2\%$ . External: dc/5 Hz - 100 kHz, 3 dB BW; dc/20 Hz - 50 kHz, 1 dB BW.

**Center frequency accuracy in DC mode:**  $< \pm 500$  Hz.

**Center frequency stability in DC mode:**  $< 10$  Hz per hour.

**FM distortion (at internal rates, pk. dev.  $\geq 3$  kHz)<sup>3</sup>:**  $< 0.5\%$ .

**Indicator accuracy (internal rates):**  $< \pm 5\%$  of setting.

**Incidental AM (dev.  $< 20$  kHz, 400 and 1 kHz,  $f_c \geq 500$  kHz):**  $< 0.1\%$ .

### Remote Programming

**Interface:** HP-IB (Hewlett-Packard's implementation of IEEE Standard 488).

**HP-IB functions:** SH0, AH1, T0, L2, SR0, RL1, PP0, DC1, DT0, C0, E1.

### General

**Operating temperature:** 0 to +55 $^\circ$ C.

**Storage temperature:** -55 to +75 $^\circ$ C.

**Leakage:** Conducted and radiated interference is within the requirements of REO2 of MIL STD 461B, and FTZ 1046. Furthermore, RF leakage of  $< 1 \mu$ V is induced in a two-turn loop, 2.5 cm in diameter, held 2.5 cm away from the front surface (typically  $< 0.05 \mu$ V,  $f_c \leq 500$  MHz).

**Save/recall/sequence storage registers:** 100 non-volatile registers are available that save front panel settings.

**Power requirements:** 100, 120, 220, or 240V (+5%, -10%) from 48 to 440 Hz, 175 VA maximum.

**Weight:** net 18.2 kg (40 lb); shipping 23.6 kg (52 lb).

**Size:** 133H  $\times$  425W  $\times$  520 mmD (5.25"  $\times$  16.75"  $\times$  20.5").

**HP System II module size:** 5/4 H  $\times$  1 MW  $\times$  17D.

### 0.3 GMSK Modulation (Option 022)

The HP 8657A Option 022 generates the 0.3 Gaussian Minimum Shift Keying (0.3 GMSK) modulation used in the Pan-European Digital Cellular Radio System. When a clock is applied, the HP 8657A Option 022 will accept data and modulate it onto the carrier, without the clock signal applied the unit functions as a standard HP 8657A.

**Carrier Frequency Range:** 10 to 130 MHz and 520 to 1040 MHz

**Data Rate:** 270.833 kHz ( $\pm 1$  kHz)

**Modulation Phase Error -**

RMS Phase Error: 3 $^\circ$  rms

Peak Phase Error: 8 $^\circ$  peak

### Ordering Information

HP8657A Synthesized Signal Generator <sup>3</sup>	Price
Opt 001 High stability timebase	+\$950
Opt 002 RF connections on rear panel only	+\$250
Opt 022 0.3 GMSK modulation	+\$5,500
Opt 907 Front handle kit (5061-9689)	+\$57
Opt 908 Rack flange kit (5061-9677)	+\$34
Opt 909 Rack flange kit with front handles (5061-9683)	+\$82
Opt 910 Provides an additional operation and calibration manual (08657-90003) and two service manuals (08657-90004)	+\$360
Opt 915 Add service manual (08657-90004)	+\$154
Opt W30 Extended repair service. See page 723.	+\$190
Opt W32 Calibration service. See page 723.	+\$510
9211-2655 Transit Case	+\$520
1494-0060 Rack Slide Kit	+\$100

<sup>3</sup> Power cable and operating manual supplied. HP-IB cables are not provided. For description and price, see page 579.

# SIGNAL GENERATORS

## Economy RF

### HP 8657B

- 100 kHz - 2060 MHz frequency coverage
- 1 Hz carrier frequency resolution
- Optional 35 nsec rise/fall time pulse modulation

- Low SSB phase noise
- $\pm 1$  dB absolute level accuracy (typically  $\pm 0.5$  dB)
- Carrier phase adjust in 1 degree increments

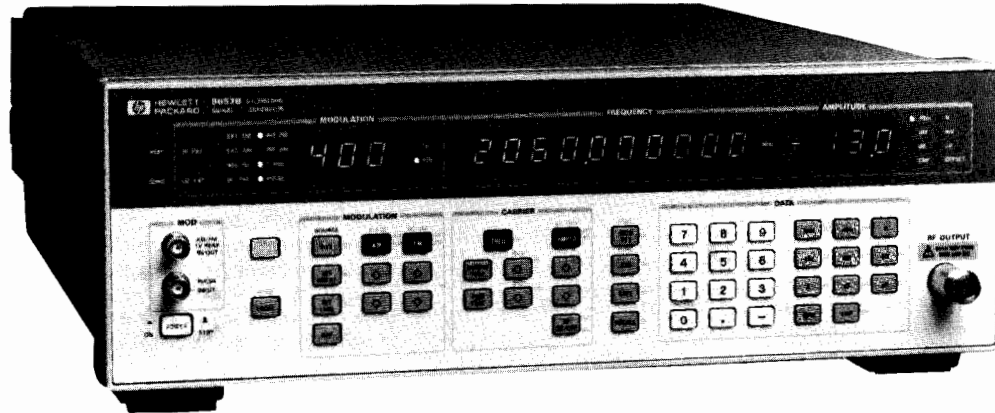

Supported by  
**HP ITG**  
Software

DESIGNED FOR  
**HP-IB**  
SYSTEMS

HP 8657B

### HP 8657B Synthesized Signal Generator

The HP 8657B is an L-Band synthesized signal generator offering excellent performance at an economical price. The HP 8657B is ideal for radio receiver and radar system and subsystem design and testing.

#### Spectral Purity for Radar and Satellite

The low residual FM and low SSB phase noise provides excellent value as a local oscillator, low noise VCO or test source with AM/FM and pulse modulation. In addition to great noise performance, features such as carrier phase adjust allow you to characterize phase sensitive devices such as phase detectors or phase interferometers using precise 1 degree phase offsets with respect to another signal source. Display blanking and nonvolatile memory clear are also available for operation in secure environments.

#### Advanced Performance

The HP 8657B offers wide dynamic output range from +13 to -143.5 dBm output level with unparalleled accuracy of  $\pm 1$  dB. Additionally, the HP 8657B has extremely low radiated emissions for making sensitivity measurements on your receiver or for design work on extremely sensitive circuitry. High stability dcFM keeps center frequency drift below 10 Hz/hour which allows accurate VCO simulation or low rate FM modulation.

#### High Performance Pulse Modulation

The HP 8657B has a GaAs FET pulse modulator (Option 003) for fast risetime, high isolation pulse. The HP 8657B has 35 to 50 nsec risetimes (typically 10 to 18 nsec) and 70 to 90 dB on/off ratios. For pulse modulation coverage to 1040 MHz only, refer to the HP 8657B Option H60.

### Specifications

#### Frequency

**Range:** 100 kHz to 2060 MHz. Underrange to 10 kHz

**Resolution:** 1 Hz

**Switching speed** (within 100 Hz of final frequency): <135 msec<sup>1</sup>

**Accuracy and stability:** Same as time base used

#### Supplemental characteristics

**Phase offset:** Signal phase is adjustable in 1° increments.

#### Timebase characteristics:

	Standard	Option 001
<b>Aging Rate</b>	$\pm 2$ ppm/yr	1.0 x 10 <sup>-9</sup> /day after 45 days
<b>Timebase Reference Signal (Rear Panel)</b>	Available at a level of >0.15 V <sub>rms</sub> into 50 $\Omega$ . (Output of 10, 5 or 1 MHz is internally selectable). If external reference is used, output will be the same frequency.	
<b>External Reference Input (Rear Panel)</b>	Accepts any 10, 5, or 1 MHz ( $\pm 0.002\%$ ) frequency standard at a level >0.15 V <sub>rms</sub> into 50 $\Omega$ .	

<sup>1</sup>Output level settles to within  $\pm 1$  dB of level in 160 msec when switching from frequencies  $\geq 130$  MHz to frequencies <130 MHz

#### Spectral Purity

##### Spurious signals ( $\leq +7$ dBm output levels)<sup>2</sup>:

Type of Spurious	Frequency (MHz)	
	0.1-1030	1030-2060
Harmonic	<-30 dBc	<-25 dBc
Sub-harmonic	None	<-40 dBc

#### Nonharmonic spurious:

Carrier Frequency	Carrier Offset	
	>5 kHz	>2 MHz
0.1 to 130 MHz	<-63 dBc	<-60 dBc
130 to 260 MHz	<-75 dBc	<-60 dBc
260 to 520 MHz	<-66 dBc	<-60 dBc
520 to 1030 MHz	<-63 dBc	<-60 dBc
1030 to 2060 MHz	<-57 dBc	<-54 dBc

#### Residual FM in Hz<sub>rms</sub> (in CW mode)

Post Detection Bandwidth	Frequency Range (MHz)				
	0.1-130	130-260	260-520	520-1030	1030-2060
0.3-3 kHz	<4 Hz	<1 Hz	<2 Hz	<3 Hz	<6 Hz
0.05-15 kHz	<6 Hz	<1.5 Hz	<3 Hz	<4 Hz	<8 Hz

#### Residual AM (50 Hz to 15 kHz BW in CW mode): <0.04% AM.

##### SSB phase noise (in CW Mode)

Carrier Frequency	SSB Noise 20 kHz Offset	(Typical) 20 kHz Offset
0.1 to 130 MHz	<-124 dBc/Hz	<-130 dBc/Hz
130 to 260 MHz	<-136 dBc/Hz	<-140 dBc/Hz
260 to 520 MHz	<-130 dBc/Hz	<-136 dBc/Hz
520 to 1030 MHz	<-124 dBc/Hz	<-130 dBc/Hz
1030 to 2060 MHz	<-118 dBc/Hz	<-123 dBc/Hz

<sup>2</sup>When  $f_c > 1030$  MHz and pulse modulation is installed, spurious specifications apply for output levels  $\geq +4$  dBm

**Output**

**Level range:** +13 dBm to -143.5 dBm into 50Ω<sup>1</sup>  
**Resolution:** 0.1 dB  
**Absolute level accuracy<sup>2</sup>:** <±1.0 dB (+3.5 to -127 dBm), <±1.5 dB (level >+3.5 dBm)  
**Level flatness (100 kHz to 2060 MHz):** <±0.5 dB, output level level setting of 0 dBm  
**SWR:** <1.5 for levels ≤-6.5 dBm; <2.0 for levels ≤+13 dBm  
**Reverse-power protection:** 50W, 25 Vdc (from a 50Ω source)  
**Supplemental characteristics**  
**Attenuator repeatability:** 0.01 dB  
**Output level overrange:** to +17 dBm

**Amplitude Modulation**

**AM depth (f<sub>c</sub> >400 kHz):** 0 to 100%, level ≤+7 dBm; 0 to 30%, level ≤+10 dBm  
**Resolution:** 1%  
**AM rate internal:** 400 Hz and 1 kHz, ±2%.  
**External:** 20 Hz - 40 kHz (1 dB), 20 Hz - 100 kHz (3 dB typical).  
**AM distortion (at 400 Hz and 1 kHz rates, levels <+10 dBm)<sup>3</sup>**

AM Depth	f <sub>c</sub> <1030 MHz	f <sub>c</sub> >1030 MHz
0 to 30% AM	<1.5% THD plus noise.	<4.0% THD plus noise
31 to 70% AM	<3.0% THD plus noise.	<4.0% THD plus noise
71 to 90% AM	<4.0% THD plus noise.	<7.0% THD plus noise

**Indicator accuracy** (for depths <90%, 400 Hz and 1 kHz rates and levels ≤+7 dBm): ±(6% of setting + 2%)

**Incidental phase modulation** (at 30% AM depth, internal rates): <0.3 radians peak

**Frequency Modulation**

**Maximum FM peak deviation (3-digit LED display)**

Center Frequency	Maximum Peak Deviation	
	ac Mode (the lesser of)	dc Mode
0.1 to 130 MHz	200 kHz or 4000 X rate (Hz)	200 kHz
130 to 260 MHz	50 kHz or 1000 X rate (Hz)	50 kHz
260 to 520 MHz	100 kHz or 2000 X rate (Hz)	100 kHz
520 to 1030 MHz	200 kHz or 4000 X rate (Hz)	200 kHz
1030 to 2060 MHz	400 kHz or 8000 X rate (Hz)	400 kHz

Minimum FM dev: FM not specified if (f<sub>c</sub> - FM dev). <100 kHz

**FM setting resolution:**

FM Deviation	Carrier Frequency	
	f <sub>c</sub> <1030 MHz	f <sub>c</sub> >1030 MHz
<100 kHz	100 Hz	200 Hz
>100 kHz	1 kHz	2 kHz

**FM rate internal:** 400 Hz and 1 kHz, ±2%

**External:** (dc) 5 Hz to 100 kHz, 3 dB bandwidth  
 (dc) 20 Hz to 50 kHz, 1 dB bandwidth

**Center frequency accuracy in dc mode**

Center Frequency	Accuracy
0.1 to 130 MHz	±500 Hz
130 to 260 MHz	±125 Hz
260 to 520 MHz	±250 Hz
520 to 1030 MHz	±500 Hz
1030 to 2060 MHz	±1000 Hz

**Center frequency stability in dc mode:** <10 Hz per hour drift.

**FM distortion** (at 400 Hz and 1 kHz rates, ≥6 kHz peak deviations)<sup>4</sup>: <0.5% THD plus noise

**Indicator accuracy** (400 Hz and 1 kHz): <±5% of setting

<sup>1</sup>When f<sub>c</sub> <1030 MHz and pulse modulation is installed, maximum output level is +10 dBm.  
<sup>2</sup>Absolute level accuracy includes allowances for detector linearity, temperature, flatness, attenuator accuracy and measurement uncertainty.

<sup>3</sup>When f<sub>c</sub> <1030 MHz and pulse modulation is installed, maximum specified output level in AM is reduced by 3 dB.

<sup>4</sup>FM distortion specification applies when: (FM dev) = 1/2 (maximum specified FM dev) for carrier frequencies below 520 MHz.

**Incidental AM** (peak dev. <20 kHz, 400 Hz and 1 kHz rates):

<0.1% AM; f<sub>c</sub> >500 kHz  
 <0.5% AM; f<sub>c</sub> >1030 MHz

**Supplemental characteristics**

**FM distortion:** worst case distortion at all specified deviations, rates, and carrier frequencies is 1.5%

**External sensitivity:** 1 Vpk for indicated accuracy (1V dc when in dc-FM mode)

**External modulation input:** Front panel BNC, 600Ω dc-coupled; front panel annunciators indicate 1 Vpk signal ±5%

**Simultaneous modulation:**

Internal/external: AM/FM, FM/AM, AM/AM, FM/FM, AM/FM/Pulse<sup>5</sup>

Internal/internal, external/external: AM/FM

**Pulse Modulation (Option 003)**

**ON/OFF ratio:** >70 dB, f<sub>c</sub> ≥130 MHz; >95 dB, f<sub>c</sub> >1030 MHz

**Rise/fall time:** 35 nsec, f<sub>c</sub> ≥130 MHz; 50 nsec, f<sub>c</sub> >1030 MHz

**Supplemental characteristics**

**Typical rise/fall time:** 10 nsec, f<sub>c</sub> >130 MHz; 18 nsec, f<sub>c</sub> >1030 MHz

**Maximum repetition rate:** dc - 30 MHz

**Remote Programming**

Interface functions implemented: SH0, AH1, T0, L2, SR0, RL1, PP0, DC1, DT0, C0, E1

**General**

**Operating temperature range:** 0° to +55°C

**Storage temperature range:** -55° to +75°C

**Leakage:** conducted and radiated interference is within the requirements of CE03 (except broadband conducted below 70 kHz), and of RE02 of MIL STD 461B, and FTZ 1115. RF leakage of less than 1.0 μV is induced in a two-turn loop, 2.5 cm in diameter, held 2.5 cm away from the front surface. (Typical leakage <0.05 μV, level <-40 dBm)

**Save/recall/sequence storage registers:** 100 non-volatile registers are available to save front panel settings

**Rear panel SEQ input level:** TTL low to recall next storage register contents

**Power requirements:** 100, 120, 220, or 240V (±10%) from 48 to 440 Hz; 125 VA maximum

**Weight:** net, 19.5kg (43lb); shipping, 25.0kg (55lb)

**Size:** 133H x 425W x 574mmD (5.25" x 16.75" x 22.6")

**HP System II cabinet module size:** 5.25"H x 1MW x 17"D

**Ordering Information**

<b>HP 8657B Signal Generator<sup>6</sup></b>	<b>Price</b>
<b>Opt 001</b> High stability timebase	\$12,600
<b>Opt 002</b> Rear panel input and output (All connectors on rear panel only)	+\$950
<b>Opt 003</b> Pulse modulator (Pulse modulator is factory installable only)	+\$250
<b>Opt 907</b> Front handle kit (5061-9689)	+\$815
<b>Opt 908</b> Rack flange kit (5061-9677)	+\$57
<b>Opt 909</b> Rack flange kit with front handles (5061-9683)	+\$34
<b>Opt 910</b> Provides an additional operation/calibration manual (08657-90006) and 2 service manuals (08657-90007)	+\$82
<b>Opt 915</b> Add service manual (08657-90007)	+\$360
<b>Opt W30</b> Extended Repair Service. See page 723.	+\$154
<b>Opt W32</b> Calibration Service. See page 723	+\$310
<b>1494-0060</b> Rack Slide Kit for HP rack enclosures	+\$585
<b>1494-0061</b> Slide Adapter Bracket Kit for non-HP rack enclosures (order with Rack Slide Kit).	\$100
<b>9211-2661</b> Transit case	\$46
	\$550

<sup>5</sup>Pulse modulation specifications apply for levels ≤+7 dBm. (Frequency switching speed typically increases by 30 msec with pulse modulation on.) Additionally, when f<sub>c</sub> >1030 MHz, AM is unspecified with pulse modulation turned on.

<sup>6</sup>HP-IB cables not included. For description and prices, see page 579.

☎ For same-day shipment, call HP DIRECT 800-538-8787

# SIGNAL GENERATORS

## High-Performance RF

### HP 8644A

- 252kHz to 1030MHz frequency range with optional coverage to 2060MHz
- -136 dBc/Hz phase noise at 20 kHz offset, 1 GHz carrier
- -100 dBc nonharmonic spurious

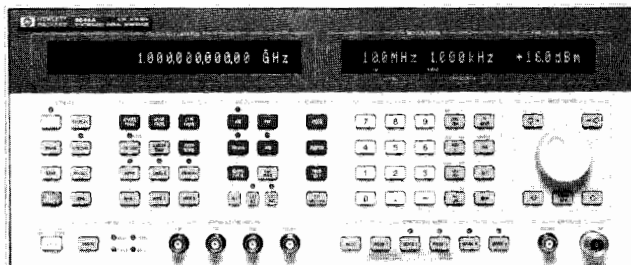

HP 8644A



### HP 8644A Synthesized Signal Generator

The HP 8644A Synthesized Signal Generator is a high performance, 252 kHz to 1030 MHz generator that provides excellent spectral purity for confidence in RF measurements. For R&D or stringent testing of communications equipment, the low phase noise and low spurious provide the measurement margin necessary for repeatability and accuracy.

The HP 8644A uses a modular platform that allows you to configure the instrument for your application.

### High Performance Modulation

For receiver measurements the HP 8644A offers AM, FM, and pulse modulation. FM deviations up to 20 MHz combined with specified rates to 100 kHz can test most communication receivers. AM performance includes 0-100% depth and rates to 100 kHz.

### Advanced Internal Modulation Source

An optional internal modulation synthesizer provides four sources each with a frequency coverage of 0.1 Hz to 400 kHz and sine, square, sawtooth, and white gaussian noise waveforms. Two of these sources can be summed together to provide two-tone capability, and one of these sources can be modulated by up to three of the sources with AM/FM/θM, and pulse. This source can also generate signals for testing VOR and ILS receivers.

### Lowest Specified Leakage of Any Signal Generator

The standard HP 8644A has typical leakage of <math>< 1 \mu\text{V}</math> induced in a two-turn loop, which is sufficient for most R&D or production testing. For sensitive measurements, Option 010, a low leakage configuration, provides more RF shielding and has typical leakage of 0.1  $\mu\text{V}$ .

### On-Site Repair and Calibration

The HP 8644A contains its own firmware and hardware for calibration, troubleshooting, and monitoring instrument performance. Built-in sensors continually monitor internal voltages to notify users of temperature drift, hardware failure, or the need for recalibration.

### HP 8644A Specifications

#### Frequency

**Range:** 251.46485 kHz to 1030 MHz; 251.46485 kHz to 2060 MHz with Opt 002. See Optional Internal Modulation Source for coverage below 252 kHz.

**Frequency bands:** The approximate endpoints of each frequency band can be determined by dividing the 1030 to 2060 MHz band by two for each band decrease.

**Stability, Opt 001:** <math>< 5 \times 10^{-10}</math>/day aging after 10 day warm-up.

- AM, FM, and pulse modulation
- Internal modulation source for complex waveforms
- Options to configure for specific applications
- On-site repair and calibration

### Typical SSB phase noise and spurs at 1 GHz.

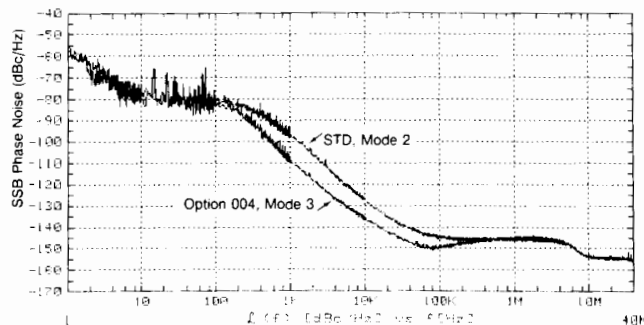

**Residual AM:** <math>< 0.01\%</math> AM rms, 0.3 to 3 kHz post detection bandwidth.

### Spectral Purity\*1

Phase noise (CW, AM, or FM<sup>2</sup> (operation)  
Standard/Option 004

Carrier Frequency (MHz)	Offset Frequency		
	1 kHz (dBc/Hz)	20 kHz (dBc/Hz)	100 kHz (dBc/Hz)
1030 - 2060	-81/-94	-121/-130	-131/-136
515 - 1030	-88/-100	-128/-136	-138/-142
257 - 515	-93/-106	-134/-142	-141/-145
128 - 257	-98/-111	-138/-145	-142/-145
64 - 128	-103/-116	-140/-145	-144/-145
32 - 64	-108/-121	-142/-145	-145/-145
16 - 32	-113/-127	-144/-145	-145/-145
8 - 16	-118/-130	-145/-145	-145/-145
4 - 8	-123/-135	-145/-145	-145/-145
2 - 4	-127/-135	-145/-145	-145/-145
1 - 2	-131/-135	-145/-145	-145/-145
0.5 - 1	-135/-135	-145/-145	-145/-145
0.25 - 0.5	-138/-135	-145/-145	-145/-145

### Spurious Signals

**Harmonics:** -30 dBc, output <math>< +8 \text{ dBm}</math>; -25 dBc, 1030 to 2060 MHz, output <math>< +8 \text{ dBm}</math>.

**Subharmonics:** none, 0.25 to 515 MHz; <math>< -55 \text{ dBc}</math>, 515 to 1030 MHz; <math>< -40 \text{ dBc}</math>, 1030 to 2060 MHz.

**Nonharmonics:** <math>< -100 \text{ dBc}</math>, >15 kHz offset, 0.25 to 1030 MHz; <math>< -94 \text{ dBc}</math>, >15 kHz offset, 1030 to 2060 MHz.

**Residual FM (CW, AM, FM operation)<sup>3 4</sup>**

Standard/Option 004

Carrier Frequency (MHz)	Post Detection Bandwidth	
	0.3 to 3 kHz (Hz rms)	0.05 to 15 kHz (Hz rms)
0.25 - 257	<math>< 1 / < 0.5</math>	<math>< 1.2 / < 0.5</math>
257 - 515	<math>< 1.2 / < 0.5</math>	<math>< 2 / < 1</math>
515 - 1030	<math>< 2 / < 1</math>	<math>< 4 / < 2</math>
1030 - 2060	<math>< 4 / < 2</math>	<math>< 8 / < 4</math>

\*1 Refer to product note HP 8644A-1 before using the HP 8644A in phase noise measurements.  
2 FM at 1% maximum specified deviation for offsets > 1 kHz, FM at minimum deviation for offsets < 1 kHz.

3 Specified for 48 to 63 Hz power line. Typical for 400 Hz power line.

4 Deviation  $\leq 0.1\%$  of maximum available.

## Output

**Maximum level:** +16 dBm, 0.25 to 1030 MHz; +13 dBm with Opt 005; Opt 002: +14 dBm, 0.25 to 1030 MHz; +13 dBm, 1030 to 2060 MHz.

**Minimum level:** -137 dBm

**Resolution:** 0.1 dB.

**Absolute accuracy:** ±1 dB, output ≥ -127 dBm.

**Reverse power protection:** 50 W from a 50 Ω source, 25 Vdc.

**Typical third order intermodulation:** <-50 dBc, outputs < 8 dBm.

**Typical output level overrange:** 2 dB more than maximum level.

**Typical SWR:** <1.7:1, output <-2 dBm.

## Modulation

**External modulation inputs:** ac or dc, for AM or FM 600Ω. Pulse, dc only.

### Amplitude Modulation

**AM depth:** 0 to 100%, for output <+7 dBm. 0.1% resolution.

**AM indicator accuracy:** ±(6% of setting +1%), up to 80% depth, 1 kHz rate.

### AM distortion, at 400 Hz and 1 kHz rates:

Depth	0.25 - 1030 MHz	1030 - 2060 MHz
0 - 30%	2%	5%
0 - 70%	3%	5%
70 - 90%	5%	8% AM

**3 dB bandwidth:** > 5 kHz, 0.25 to 8 MHz. >50 kHz, 8 to 128 MHz; >100 kHz, 128 to 2060 MHz.

## Frequency Modulation

**FM deviation range:** 20 MHz for carriers from 1030 to 2060 MHz. Maximum deviation divides in half for each carrier band lower.

**FM maximum rate:** 100 kHz, 8-2060 MHz 19.5 kHz, 1-2 MHz  
78 kHz, 4-8 MHz 9.7 kHz, .5-1 MHz  
39 kHz, 2-4 MHz 4.8 kHz, .25-.5 MHz

	Mode 1	Mode 2	(Mode 3 opt. 004)
FM indicator accuracy: <sup>5</sup> Rates: 0-30 kHz 30-100 kHz	12% 20%	5% 10%	5%, (6% mode 3*) 10%, (15% mode 3*)
FM Distortion: (20 Hz - 100 kHz rates)	3%	5%	1%

\* With Option 004, the signal generator defaults to mode 3 for the allowable deviations. For improved FM indicator accuracy, Mode 2 may be selected manually. This degrades spectral purity to that available with Mode 2.

<sup>5</sup> Accuracy at time of setting for rates that do not exceed maximum rate.

**Carrier frequency accuracy in FM:** ±0.5% of FM deviation setting.

## Pulse Modulation

**On/off ratio:** >35 dB; >80 dB for 1030 to 2060 MHz.

**Rise fall time:** <100 nsec, between 10% and 90% response points.

**Maximum pulse repetition frequency:** 1 MHz.

**Minimum pulse width:** 0.5 μsec.

## Internal Modulation Source

**Rates:** 0.3, 0.4, 1, 3 kHz. Accuracy ±5%.

## Optional Internal Modulation Source

**Frequency range:** 0.1 Hz to 400 kHz; 0.1 Hz resolution.

**Maximum output level:** 0 to 2 V<sub>pk</sub> into 600 Ω; 2 mV resolution.

## Phase Continuous Sweep

**Sweep type:** linear, phase continuous.

**Sweep time:** 20 ms to 10 s.

**Maximum sweep span:** twice maximum FM deviation.

## Digitally Stepped Sweep

**Sweep type:** linear or log, frequency stepped.

**Sweep time:** 500 ms to 1000 s

## Remote Programming

**Interface/language:** HP-IB/HP-SL (HP systems language)

## General

**Power requirements:** ±10% of 100, 120, 220, or 240V; 48 to 440 Hz 400 VA maximum.

**Operating temperature range:** 0 to 55°C.

**Storage temperature range:** -55 to +75°C.

**Leakage:** Typical leakage is <1 μV induced in a two-turn loop 1 inch from any surface with output level <0 dBm; <0.1 μV with Opt 010.

**Calibration interval:** 3 years (MTBC).

**Storage registers:** 10 full function and 40 frequency/amplitude.

**Weight:** net, 28 kg (61 lb); shipping, 35 kg (77 lb).

**Size:** 178 x 425 x 648mmD (7" x 16.75" x 23.5"). Opt 010 adds 35mm (1.4") to the depth.

## Avionics Specifications

Option 009 provides specified VOR/ILS performance for the HP 8644A with Option 007. These specifications apply when using the HP 8644A with Option 007 to generate standard VOR and ILS signals. Can not be ordered with Option 002 or Option 005.

**VOR bearing accuracy:** 0.1 degrees.

**VOR, LOC, G/S AM accuracy:** ±5% of setting.

**VOR, LOC, G/S AM distortion:** 2%.

**VOR FM accuracy (480 Hz deviation):** ±1.5 Hz.

**Localizer DDM resolution:** 0.0002 DDM.

**Localizer DDM accuracy:** ±0.0004 ±5% of DDM.

**Glide slope DDM resolution:** 0.0004 DDM.

**Glide slope DDM accuracy:** ±0.0008 ±5% of DDM.

**Marker beacon AM accuracy (95% AM):** ±5% of setting +1%.

**Marker beacon AM distortion (95% AM):** 5%.

## Frequency Counter Specifications

Option 011 provides an optional frequency counter.

**Frequency range:** selectable from 20 Hz to 2 GHz.

**Impedance:** 20 GHz to 10 MHz, 1 mΩ shunted by less than 65 pF.  
10 MHz to 2 GHz, 50Ω nominal.

**Sensitivity:** 25 mV rms -19 dBm into 50Ω

**Gate times:** adjustable in 0.1 s steps from 0.1 s to 1 s.

**Measurement resolution (Hz):**  $\frac{\text{Measured frequency (Hz)} \times 10^{-8}}{\text{Gate time(s)}}$   
or 0.01 Hz, which ever is greater.

**Measurement uncertainty:** +/- timebase accuracy plus +/- measurement resolution.

## Ordering Information

	Price
HP 8644A Synthesized Signal Generator <sup>1</sup>	\$17,200
Opt 001 High stability time base	+\$1,550
Opt 002 2 GHz doubled output	+\$7,150
Opt 003 RF connectors on rear panel only	+\$400
Opt 004 Enhanced spectral purity	+\$4,100
Opt 005 Electronic attenuator (5-year warranty on attenuator, cannot be used with Opt 002)	+\$500
Opt 007 Synthesized audio oscillator	+\$1,050
Opt 009 Specified VOR/ILS performance (can not be ordered with Opt 002 or Opt 005)	+\$1,500
Opt 010 Reduced leakage configuration	+\$1,500
Opt 011 2 GHz frequency counter	+\$1,000
Opt 907 Front handle kit (5061-9690)	+\$65
Opt 908 Rack flange kit (5061-9678)	+\$35
Opt 909 Rack flange kit with front handles (5061-9684)	+\$90
Opt 910 Provides an additional operation and calibration manual (08644-90009) and two service manuals (08645-90024)	+\$190
Opt 915 Add service manual (08645-90024)	+\$65
Opt W30 Extended repair service. See page 723.	
08645-61116 Service kit	+\$500

<sup>1</sup> HP-IB cables not included. For description and price, see page 579.

☎ For same-day shipment, call HP DIRECT at 800-538-8787

# SIGNAL GENERATORS

## High-Performance RF

HP 8642A, 8642B

- 100 kHz to 2.115 GHz
- $< -134$  dBc/Hz SSB phase noise at 20 kHz offset
- $-100$  dBc nonharmonic spurious

- +20 dBm maximum output level
- AM, FM,  $\Phi$ M and pulse modulation
- On-site repair and calibration

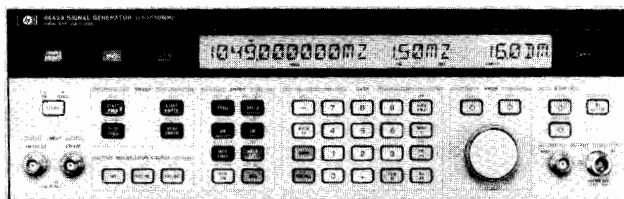

HP 8642A

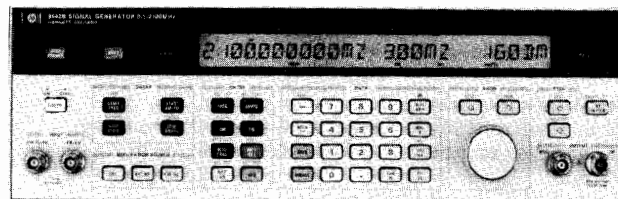

HP 8642B



### HP 8642A/B Synthesized Signal Generators

The HP 8642A and HP 8642B synthesized signal generators are high performance programmable signal generators intended for the most demanding out-of-channel RF receiver measurements and other stringent RF applications. The HP 8642A covers the frequency range from 100 kHz to 1057.5 MHz and the HP 8642B to 2115 MHz.

#### Low SSB Phase Noise

The HP 8642A/B provide state-of-the-art in SSB phase noise at 20 kHz offsets of  $-134$  dBc/Hz at 1 GHz.

#### $-100$ dBc Spurious

Nonharmonic spurious are held to below  $-100$  dBc on the HP 8642A/B up to 1 GHz and to below  $-94$  dBc above 1 GHz. These two generators allow receiver spurious rejection tests to be fully automated with the utmost confidence in test results.

#### Repeatability and Level Accuracy

In addition to a high-reliability attenuator, absolute output level accuracy is  $\pm 1$  dB down to  $-127$  dBm ( $0.1 \mu\text{V}$ ). In R&D or on the production line, the HP 8642A/B will accurately measure receiver sensitivities.

#### Up to +20 dBm Output Level

Up to +20 dBm is available from the HP 8642A/B to perform a variety of high level measurements, often eliminating the need for external amplifiers.

This extra power can be used to overcome cabling losses. With the relative amplitude feature, the display can be offset to show correct output level at the end of the cable.

#### AM, FM, $\Phi$ M and Pulse Modulation

The HP 8642A/B offer AM, FM,  $\Phi$ M and pulse modulation across their full frequency ranges.

A low distortion internal modulation oscillator can be used to modulate the HP 8642A/B up to 100 kHz rates. The internal audio oscillator can also be used as a stand-alone audio source with variable rates and levels.

### HP 8642A/B Specifications

#### Frequency

**Range:** 100 kHz to 1057.5 MHz, HP 8642A; 100 kHz to 2115 MHz, HP 8642B.

**Bands:** Both generators cover their ranges in one continuous span. However, many other specifications are dependent on carrier frequency. To simplify such specifications, the HP 8642A and 8642B carrier frequency ranges are divided into bands shown in the table below.

Band	Carrier Frequency (MHz)	Band	Carrier Frequency (MHz)
10	1057.500001-2115 (HP 8642B)	4	16.523438- 33.046875
9	528.750001-1057.5	3	8.261719- 16.523437
8	264.375001- 528.75	2	4.130860- 8.261718
7	132.187501- 264.375	1	0.1 - 4.130859
6	66.093751- 132.1875	HET	0.1 -132.1875
5	33.046876- 66.09375		

**Resolution:** 1 Hz, 0.1 Hz with special function.

**Stability:** same as reference oscillator.

#### Internal Reference Oscillator

**Standard:** aging rate:  $\pm 2$  ppm/year; **Option 001:**  $< 10^{-9}$ /day aging rate after 8 days warm-up.

#### Spectral Purity

**Residual FM** (in CW, AM or Angle Modulation  $< 1/2$  Max. Dev.):

**500 MHz:**  $< 1.2$  Hz (0.3 - 3 kHz BW),  $< 2$  Hz (0.05 - 15 kHz BW);

**1000 MHz:**  $< 2$  Hz (0.3 - 3 kHz BW),  $< 5$  Hz (0.05 - 15 kHz BW);

**2000 MHz:**  $< 5$  Hz (0.3 - 3 kHz BW),  $< 9$  Hz (0.05 - 15 kHz BW).

**SSB Phase Noise at 20 kHz offset** (CW, AM or FM/ $\Phi$ M  $< 1/60$  Maximum Deviation):

**125 MHz:**  $-144$  dBc/Hz;

**250 MHz:**  $-141$  dBc/Hz;

**500 MHz:**  $-137$  dBc/Hz;

**1000 MHz:**  $-134$  dBc/Hz;

**2000 MHz:**  $-125$  dBc/Hz.

**Residual AM:**  $< 0.01\%$  AM rms, 0.3 - 3 kHz BW.

#### Spurious

**Harmonics:**  $-30$  dBc, level  $\leq +10$  dBm,  $-25$  dBc  $f_c > 1057.5$  MHz.

**Subharmonics:** none,  $f_c \leq 1057.5$  MHz;  $-45$  dBc,  $f_c > 1057.5$  MHz.

**Nonharmonics** ( $> 10$  kHz offsets):  $-100$  dBc, ( $-94$  dBc  $f_c > 1057.5$  MHz).

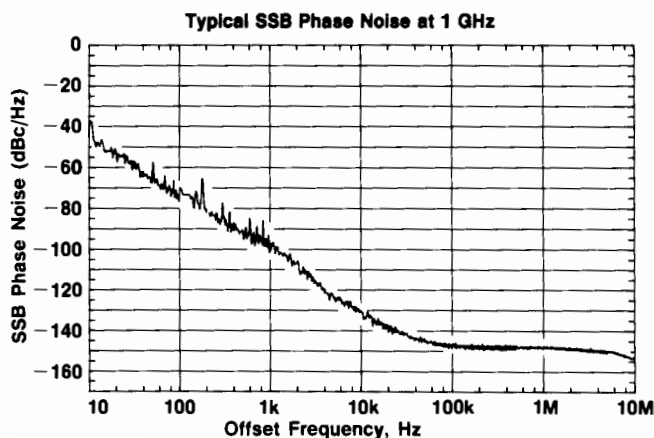

**Level range:** from maximum available to -140 dBm (0.023 μV).

**Maximum Level Available:**

	HP 8642A	HP 8642B
+20 dBm (2.24V)	bands 1 thru 7	bands 1 thru 7
+19 dBm (2.00V)	n/a	band 8
+18 dBm (1.78V)	bands 8 & HET	HET
+17 dBm (1.58V)	n/a	band 9
+16 dBm (1.41V)	band 9	band 10

**Resolution:** 0.1 dB.

**Absolute accuracy:** ±1 dB, output level ≥ -127 dBm.

**Flatness:** ≤ ±0.75 dB, +10 dBm output level.

**Impedance:** 50Ω nominal.

**SWR:** <1.5:1, level <0 dBm; <2.0:1, level ≥0 dBm.

**Reverse power protection:** 50W, from a 50Ω source 25 Vdc (HP 8642A), 25W, 50 Vdc (HP 8642B).

**Third order intermodulation:** <-50 dBc at +10 dBm, two generators 25 kHz apart into a resistive combiner. Typically decreases 10 dB for every 5 dB of combined level decrease.

**Amplitude Modulation**

**AM depth:** 0 to 99.9%, output level ≤ +10 dBm.

**AM resolution:** 0.1%.

**AM indicator accuracy at 1 kHz rate and up to 90% AM:**

±(3.5% of setting +1% AM),  $f_c \leq 528.75$  MHz (8642A),  $f_c \leq 1057.5$  MHz (8642B);

±(5% of setting +1% AM),  $f_c > 528.75$  MHz (8642A),  $f_c > 1057.5$  MHz (8642B).

**AM distortion at 1 kHz rate:**

Depth	Distortion	
	8642A; $f_c \leq 528.75$ MHz 8642B; $f_c \leq 1057.5$ MHz	8642A; $f_c > 528.75$ MHz 8642B; $f_c > 1057.5$ MHz
0 to 30% AM	<1%	<2%
30 to 70% AM	<2%	<4%
70 to 90% AM	<4%	<6%

**AM 3 dB bandwidth, depth ≤90%:**

**External dc/ac coupling:** dc/20 Hz to 100 kHz,  $f_c$ : 01-4.13 MHz, 33.04-2115 MHz, HET; dc/20 Hz to 20 kHz,  $f_c$ : 4.13-33.04 MHz.

**Internal:** same as external ac.

**Incidental 9M at 1 kHz rate and 30% AM:** <0.2 radians peak.

**Phase Modulation**

**Maximum FM deviation:**

Carrier Frequency Band	Maximum Deviation DC Coupled	Maximum Deviation AC Coupled or Internal
10	3 MHz	(the smaller of) 3 MHz or $f_{mod} \times 2160$
9	1.5 MHz	1.5 MHz or $f_{mod} \times 1080$
8	750 kHz	750 kHz or $f_{mod} \times 540$
7	375 kHz	375 kHz or $f_{mod} \times 270$
6	187 kHz	187 kHz or $f_{mod} \times 135$
5	93.8 kHz	93.8 kHz or $f_{mod} \times 67.5$
4	46.9 kHz	46.9 kHz or $f_{mod} \times 33.75$
3	23.4 kHz	23.4 kHz or $f_{mod} \times 16.88$
2	11.7 kHz	11.7 kHz or $f_{mod} \times 8.44$
1	93.8 kHz	93.8 kHz or $f_{mod} \times 67.5$
HET	1.5 MHz	1.5 MHz or $f_{mod} \times 1080$

**FM resolution:** 0.7% of setting or 0.0004% of maximum deviation, whichever is larger.

**FM indicator accuracy, rates ≤ 100 kHz:** ±(5% of setting +10 Hz).

**FM distortion, rates 20 Hz to 100 kHz:** 4% for max. dev., 2% for 1/2 max. dev., 0.4% for 1/10 maximum dc coupled deviation.

**FM 3 dB bandwidth: (dc/ac coupling):** dc/20 Hz to 200 kHz.

**Incidental AM:** 0.3%, 20 kHz peak dev., 1 kHz rate,  $f_c > 400$  kHz.

**Phase Modulation**

**Maximum phase deviation:**

Carrier Frequency Band	Maximum Deviation (Radians)
10	200
9	100
8	50
7	25
6	12.5
5	6.25
4	3.13
3	1.56
2	0.78
1	6.25
HET	100

**9M accuracy:** ±(5% of setting +0.09 radians), 1 kHz rate.

**9M resolution:** Greater of 0.7% of setting or 0.0004% of max. dev.

**9M distortion:** <0.4%, 1 kHz rate.

**9M 3 dB bandwidth:** dc/20 Hz to 15 kHz.

**Pulse Modulation (for output levels ≤ +15 dBm):**

**Pulse on/off ratio:** >40 dB; >80 dB,  $f_c > 1057.5$  MHz.

**Rise/fall time:** <400 ns, 10% to 90%.

**Maximum repetition frequency:** 100 kHz.

**Minimum pulse width:** 2 μs.

**Internal Modulation Oscillator**

**Rates:** 20 Hz to 100 kHz.

**Frequency resolution:** 1% of setting.

**Frequency accuracy:** 2% of setting.

**Output level range:** 0 to 3V peak into 600Ω.

**Output level resolution:** 4 mV.

**Distortion:** <0.02%, 0.02 kHz to 15.8 kHz; <0.15%, >15.8 kHz.

**Output level accuracy:** ±(4% +15 mV) within 1 second.

**Output impedance:** 600Ω ±10%.

**Frequency Sweep**

**Modes:** Start-Stop, Span, and Phase continuous.

**X axis output:** 0 to 10 Vdc, ±10%.

**Z axis output:** TTL positive true for display blanking during retrace.

**Remote Programming**

**Interface:** HP-IB (IEEE-488-1978).

**HP-IB functions:** listener, talker, and controller. SH1, AH1, T5, TE0, L3, LE0, SR1, RL1, PP1, DC1, DT1, C1, C3, C28, E2.

**General**

**Operating temperature range:** 0° to 55° C.

**Storage temperature:** -55° C to +75° C.

**Leakage:** conducted and radiated interference is within the requirements of MIL-STD-461B method RE02. Interference is also within the standards set by FTZ-1046. Also, RF leakage of <0.5 μV is induced in a two turn loop 2.5 cm in diameter, held 2.5 cm away from any surface for output levels ≤0 dBm.

**Power requirements:** 100, 120, 220, or 240V; +5%, -10%; 48 to 440 Hz; 300 VA max.

**Size:** 133H x 425W x 617D mm (5.25" x 16.75" x 24.3").

**HP System II module size:** 5/4H x 1MW x 23D.

**Weight:** Net, 32.7 kg (71.5 lb); shipping, 43 kg (95 lb).

**Ordering Information**

HP 8642A Synthesized Signal Generator<sup>1</sup> \$27,900

HP 8642B Synthesized Signal Generator<sup>1</sup> \$38,200

Opt 001 High stability time base +\$2,350

Opt 002 Input/output connectors on rear panel only +\$165

Opt 710 On-site repair manual (08642-90020) +\$74

Opt 907 Front handle kit (5061-9689) +\$57

Opt 908 Rack flange kit (5061-9677) +\$33

Opt 909 Rack flange kit (5061-9683) with front handles +\$82

Opt 910 Provides an additional operation and calibration manual (08642-90224) and two service manuals (08642-90226) +\$565

Opt 915 Add service manual (08642-90026) +\$255

HP 8642A Opt W30 Extended repair service. See page 723. +\$615

HP 8642B Opt W30 Extended repair service. See page 723. +\$845

HP 11801A On-site repair kit for HP 8642A \$21,100

HP 11801B On-site repair kit for HP 8642B \$27,800

HP 11801C On-site repair kit for HP 8642A/B \$29,350

<sup>1</sup>HP-IB cables not supplied. For description and price, see page 579.

☎ For same-day shipment, call HP Direct at 800-598-8787

# SIGNAL GENERATORS

## High-Performance RF HP 8660D

- 10 kHz to 2600 MHz
- Synthesizer stability and accuracy
- 1 Hz resolution (2 Hz above 1300 MHz)

- Ten digit display
- Calibrated output over > 140 dB range
- AM, FM,  $\Phi$ M, or pulse modulation



HP 8660D (with HP 86633B and HP 86603A plug-ins)

### HP 8660D Synthesized Signal Generator

#### System Concept

The HP 8660 is a modular, solid-state, plug-in system. Each system includes: 1) a programmable, synthesized signal generator mainframe, 2) an RF section plug-in, and 3) a modulation section. Synthesized accuracy and stability, along with complete programmability, make the HP 8660 ideal for automated receiver, subsystem and component testing.

#### Mainframes

The HP 8660D offers front panel and HP-IB or BCD control of center frequency and frequency sweep. An external reference may be used to replace the internal, high stability reference oscillator.

#### Plug-In RF Sections

The HP 86601A (0.01 – 110 MHz), HP 86602B (1 – 1300 MHz), and HP 86603A (1 – 2600 MHz) are the three RF section choices. The HP 11661B Frequency Extension Module (mainframe Option 100) must be used with the HP 86602B and HP 86603A and is installed internally to an HP 8660 mainframe. (When using the HP 8660A mainframe, the HP 86603A plug-in must be ordered with Option 003.)

#### Plug-In Modulation

There are five modulation sections from which to choose. The HP 86631B Auxiliary Section provides external AM and pulse modulation. The HP 86632B offers AM and FM and utilizes a free-running VCO to provide high FM deviations and rates while the HP 86633B provides AM and phase locked FM. The HP 86634A offers high performance phase modulation with rates to 10 MHz while the HP 86635A provides both FM and phase modulation. (The HP 86634A and HP 86635A must be used with Option 002 RF Section.)

### HP 8660D Mainframe Specifications

**Frequency accuracy and stability:** CW frequency accuracy and long term stability are determined by internal reference oscillator, or by external reference.

#### Reference Oscillator

**Internal:** 10 MHz quartz oscillator. Aging rate less than  $\pm 3$  parts in  $10^9$  per 24 hours.

**External:** rear panel switch allows operation from 5 MHz or 10 MHz frequency standard at a level between 0.5 and 2.5 Vrms into 170 ohms.

**Reference output:** rear panel BNC connector provides output of reference signal selected at level of at least 0.75 Vrms into 170 ohms.

**Digital sweep:** auto, single, or manual. Selectable speeds 0.1, 1, or 50 seconds.

### Remote Programming

#### Functions

**HP 8660D:** CW frequency, frequency stepping (STEP $\uparrow$ , STEP $\downarrow$ ), output level, and most modulation functions are programmable.

#### Programming Input

**Connector type:** 36-pin Cinch type 57 (mating connector supplied). 24-pin Cinch type 57 for HP-IB control. BCD and HP-IB control internal jumper selectable.

**Logic:** TTL compatible (negative true).

**Switching time:** less than 10 ms to be within 100 Hz of any new frequency selected. (Less than 175 ms to be within 10 Hz.)

### General

**Operating temperature range:** 0° to +55°C.

**Power:** 100, 120 (+5%, -10%), 48-400 Hz; 220, 240V (+5%, -10%), 48-66 Hz; approximately 350 watts.

**Weight (mainframe only):** net, 23.8 kg (53 lb). Shipping, 29.6 kg (65 lb).

### Supplemental Characteristics

#### Typical Single Sideband Phase Noise

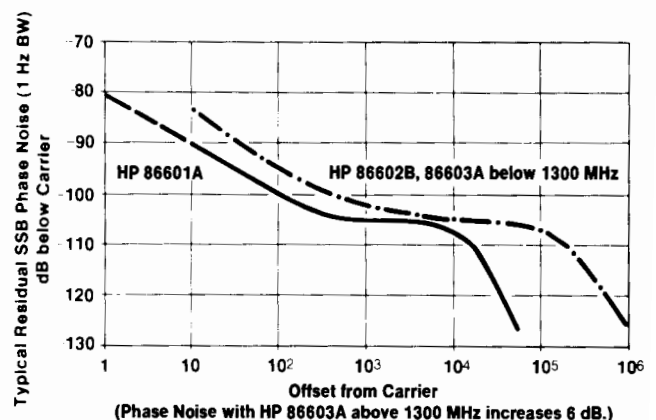



10 kHz to 110 MHz

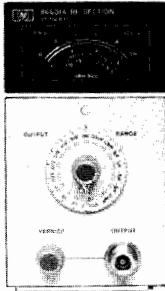

HP 86601A

1 MHz to 1300 MHz

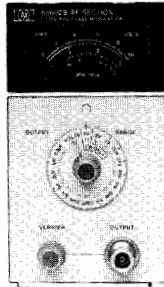

HP 86602B (HP 11661B required)

1 MHz to 2600 MHz

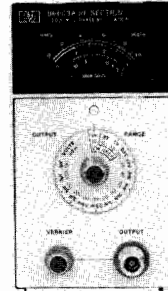

HP 86603A (HP 11661B required)

**RF Section Specifications** (installed in HP 8660D mainframe)

		HP 86601A	HP 86602B (requires HP 11661B)	HP 86603A (requires HP 11661B)		
FREQUENCY CHARACTERISTICS	Frequency Range	0.01–110 MHz (109.999999 MHz)	1–1300 MHz (1299.999999 MHz)	1–2600 MHz (2599.999999 MHz)		
	Frequency Resolution	1 Hz	1 Hz	CF < 1300 MHz	CF ≥ 1300 MHz	
	Harmonics	≤ -40 dBc	≤ -30 dBc (< -25 dBc above +3 dBm)	≤ -20 dBc <sup>1</sup>		
	Spurious Non Harmonically Related (greater than 10 KHz offsets)	≤ -76 dBc	≤ -80 dBc below 700 MHz ≤ -80 dBc above 700 MHz within 45 MHz of carrier ≤ -70 dBc above 700 MHz > 45 MHz from carrier	≤ -74 dBc within 45 MHz of carrier <sup>1</sup> ≤ -64 dBc > 45 MHz from carrier		
	Power Line Related (CW, AM, φM only) <sup>2</sup>	≤ -60 dBc	≤ -50 dBc on +10 dBm range ≤ -60 dBc	≤ -60 dBc		
Signal To Phase Noise Ratio (CW, AM, φM only, offsets > 300 Hz)	> 50 dB	> 45 dB	> 39 dB			
OUTPUT CHARACTERISTICS	Output Level (into 50Ω)	+13 dBm to -146 dBm	+10 to -146 dBm	+10 to -136 dBm	+7 to -136 dBm <sup>3</sup>	
	Output Accuracy (local and remote)	± 1 dB, +13 to -66 dBm ± 2 dB, -66 to -146 dBm	± 1.5 to -76 dBm ± 2.0 to -146 dBm	± 2.5 dB to -76 dBm <sup>3</sup> ± 3.5 dB to -136 dBm		
	Flatness (output level variation with frequency)	< ± 0.75 dB	< ± 1.0 dB	< ± 2.0 dB		
	Impedance	50Ω				
MODULATION CHARACTERISTICS	AM	AM Modulation Depth	0 to 95%	0 to 90% <sup>4</sup>	0 to 50% <sup>4</sup>	
		3 dB Bandwidth:	0–30%	200 Hz, CF < 0.4 MHz 10 kHz, 0.4 < CF < 4 MHz 100 kHz, CF ≥ 4 MHz	10 kHz, CF < 10 MHz 100 kHz, CF ≥ 10 MHz	5 kHz
			0–70%	125 Hz, CF < 0.4 MHz 6 kHz, 0.4 < CF < 4 MHz 60 kHz, CF ≥ 4 MHz	6 kHz, CF < 10 MHz 60 kHz, CF ≥ 10 MHz	N/A
			0–90%	100 Hz, CF < 0.4 MHz 5 kHz, 0.4 < CF < 4 MHz 50 kHz, CF ≥ 4 MHz	5 kHz, CF < 10 MHz 50 kHz, CF ≥ 10 MHz	N/A
		Distortion, THD at 30% AM at 70% AM at 90% AM	< 1%, 0.4–110 MHz < 3%, 0.4–110 MHz < 5%, 0.4–110 MHz	< 1% < 3% < 5%	< 5% N/A N/A	
	FM	FM Rate	dc to 1 MHz with HP 86632B and HP 86635A 20 Hz to 100 kHz with HP 86633B	dc to 200 kHz with HP 86632B and HP 86635A 20 Hz to 100 kHz with HP 86633B		
		Maximum Deviation (peak)	1 MHz with HP 86632B and HP 86635A 100 kHz with HP 86633B	200 kHz with HP 86632B and HP 86635A 100 kHz with HP 86633B	400 kHz w/HP 86632B, 86635A 200 kHz w/HP 86633B	
		Distortion, THD (at rates up to 20 kHz)	< 1% up to 200 kHz dev. < 3% up to 1 MHz dev.	< 1% up to 200 kHz dev.		
	PULSE	Pulse Rise/Fall Time	200 ns	50 ns		
		ON/OFF Ratio (with pulse level control at max.)	> 50 dB	> 40 dB		
φM	φM Rate	N/A	dc to 1 MHz with HP 86635A dc to 1 MHz for CF < 100 MHz dc to 10 MHz for CF ≥ 100 MHz with HP 86634A			
	Maximum Peak Deviation	N/A	0 to 100 degrees		0 to 200 degrees	
	Distortion, THD	N/A	< 5% up to 1 MHz rates < 7% up to 5 MHz rates < 15% up to 10 MHz rates			
GENERAL	Weight	Net 5 kg (11 lb) Shipping 6.8 kg (15 lb)	Net 4.1 kg (9 lb) Shipping 5.5 kg (12 lb)	Net 5 kg (11 lb) Shipping 6.4 kg (14 lb)		
		HP 11661B: Net 2.3 kg (5 lb); shipping 2.7 kg (6 lb)				

<sup>1</sup>For output levels +3 dBm and below; slightly higher +3 to +7 dBm.

<sup>2</sup>Measured in a 30 kHz band centered on the carrier excluding a 1 Hz band centered on the carrier.

<sup>3</sup>For +3 to +7 dBm output levels, output accuracy and flatness will be slightly degraded (above 1300 MHz only)

<sup>4</sup>For RF output level meter readings from +3 dB to -6 dB and only at +3 dBm and below.

<sup>5</sup>Applies only at 400 Hz and 1 kHz rates with output meter set between 0 and +3 dB. At -6 dB meter setting the distortion approximately doubles.

<sup>6</sup>Phase modulation is only possible with Option 002 RF Sections.

# SIGNAL GENERATORS

## High-Performance RF (Cont'd)

HP 86631B-86633B, 86634A-86635A

Pulse/AM

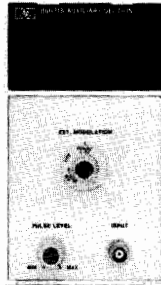

HP 86631B

AM/High Deviation FM

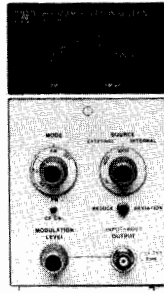

HP 86632B

AM/ $\phi$  Locked FM

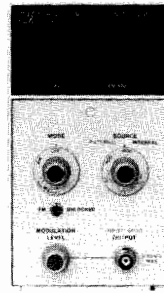

HP 86633B

High rate  $\phi$ M

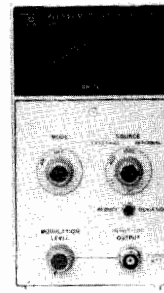

HP 86634A

$\phi$ M/FM

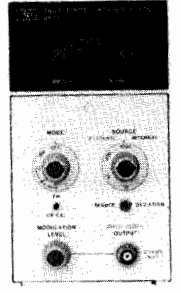

HP 86635A

### Modulation Section Specifications

		HP 86631B	HP 86632B	HP 86633B	HP 86634A	HP 86635A
	Functions	Ext. Only	Int. and Ext.	Int. and Ext.	—	—
AM	Indicated Accuracy (at 400 and 1000 Hz rates)	—	±5% of full scale With HP 86601A RF Section: ±7%, center frequency ≥100 MHz. With HP 86603A RF Section: ±10%, center frequency ≥1300 MHz.		—	—
FM	Functions	—	Int. and Ext., FM CF CAL	Int. and Ext.	—	Int. and Ext., FM CF CAL
	Center Frequency Long Term Stability	—	Typically less than 1 kHz/hr	Same as in CW Mode ( $3 \times 10^{-9}$ /day)	—	Typically less than 1 kHz/hr
	Indicated Accuracy (up to 20 kHz rates)	—	±5% of full scale		—	±5% of full scale
Pulse	Functions	Ext. Only	—	—	—	—
$\phi$ M	Functions	—	—	—	Int. and Ext.	Int. and Ext.
	Indicated Accuracy (15°C to 35°C)	—	—	—	±5% of full scale up to 100 kHz rates ±8% of full scale up to 2 MHz rates ±15% of full scale up to 10 MHz rates	
Meter		—	0–100% AM 0–10, 100, 1000 kHz FM Pk. Dev. (0–20, 200, 2000 kHz FM for CF ≥1300 MHz)	0–100% AM 0–10, 100 kHz FM Pk. dev. (0–20, 200 kHz FM for CF ≥1300 MHz)	0–100° Peak $\phi$ M (0–200° for CF ≥ 1300 MHz)	0–10, 100, 1000 kHz FM, 0–100° Pk. $\phi$ M (0–20, 200, 2000 kHz FM, 0–200° Pk. $\phi$ M for CF ≥1300 MHz)
Internal Modulation Source Output		None	400 Hz and 1 kHz ±5% 200 mV minimum into 10 k $\Omega$ . Available at front panel BNC connector			
Input Impedance		50 $\Omega$ Pulse 600 $\Omega$ AM	600 $\Omega$	600 $\Omega$	50 $\Omega$	600 $\Omega$
Weight		Net, 1.4 kg (3 lb) Shipping, 2.3 kg (5 lb)	Net, 2.7 kg (6 lb) Shipping, 4.1 kg (9 lb)	Net, 2.7 kg (6 lb) Shipping, 4.1 kg (9 lb)	Net, 1.8 kg (4 lb) Shipping, 3.2 kg (7 lb)	Net, 2.7 kg (6 lb) Shipping, 4.1 kg (9 lb)

### Ordering Information

HP 8660D Synthesized Signal Generator mainframe<sup>1</sup>

Opt 001  $\pm 3 \times 10^{-9}$ /day internal reference oscillator

Opt 002 No internal reference oscillator

Opt 003 Operation from 48 to 440 Hz line

Opt 005 Factory configured for HP-1B programming operation.

Opt 100 HP 11661B factory installed inside main frame

Opt 908 Rack flange kit (08660-60347)

Opt 910 Provides an additional operation and calibration manual (08660-90103) and two service manuals (08660-90104)

Opt 915 Add service manual (08660-90104)

Opt W30 Extended repair service. See page 723.

HP 86601A 0.01–110 MHz RF Section

<sup>1</sup>HP1B cables not supplied. For description and price, see page 579.

☎ For same-day shipment, call HP Direct at 800-538-8787

### Price

\$16,200

\$0

– \$300

\$0

\$0

+ \$6,850

+ \$113

+ \$255

+ \$103

+ \$355

\$8,380

HP 86602B 1–1300 MHz RF Section<sup>2</sup>

HP 86603A 1–2600 MHz RF Section<sup>2</sup>

Opt 002 adds phase modulation capability  
(HP 86602B, 86603A only)

Opt 003 allows operation of HP 86603A with  
HP 8660A mainframe

HP 86607A field retrofit for HP 8660A/C to HP  
8660D

HP 86631B AM/Pulse Auxiliary Section

HP 86632B AM/FM Modulation Section

HP 86633B AM/FM Modulation Section

HP 86634A  $\phi$ M Modulation Section

HP 86635A  $\phi$ M/FM Modulation Section

Note: Opt 910, 2 sets of operation and service manuals, is available for each modulation section. Contact your HP sales representative for part numbers and prices.

HP 11661B Frequency Extension Module

HP 11672A Service Accessory Kit

HP 11707A Test Plug-in

<sup>2</sup>HP 86602B and HP 86603A RF sections require an HP 11661B for operation.

\$9,500

\$11,760

+ \$2,600

+ \$255

\$4,900

\$825

\$3,950

\$3,950

\$3,150

\$4,350

\$6,850

\$1,510

\$2,930

- 10 kHz to 1280 MHz frequency range
- $< -147$  dBc/Hz SSB phase noise at 10 kHz offset
- 0.1 Hz frequency resolution

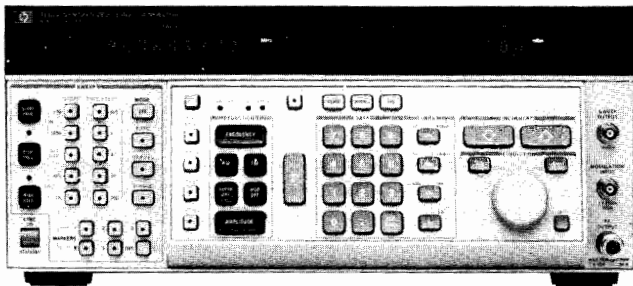

HP 8662A



### HP 8662A Synthesized Signal Generator

The HP 8662A derives exceptional RF performance from an indirect frequency synthesis technique that results in frequency resolution of 0.1 Hz from 10 kHz to 640 MHz and 0.2 Hz from 640 MHz to 1280 MHz.

Output level accuracy is held to  $\pm 1$  dB using microprocessor correction. This makes the HP 8662A an ideal generator for performing precise receiver sensitivity tests either manually or in automated systems.

The HP 8662A offers versatile phase-locked AM/FM using either internal 400 Hz and 1 kHz rates or externally applied modulating signals, which can be either dc or ac coupled. Several different modes of simultaneous modulation (such as AM + FM or FM + FM) are possible.

#### Exceptional Spectral Purity

The key contribution of the HP 8662A is spectral purity. Fast-tuning, switched-inductance, voltage-controlled oscillators combined with a low noise reference multiplication chain result in very low SSB phase noise, especially at small offsets from the carrier. The phase noise at 20 kHz to 50 kHz offsets is comparable to that of the best cavity-tuned fundamental oscillators. Such excellent noise performance makes possible complete automation of receiver out-of-channel measurements.

With its excellent long and short-term frequency stability, high output power, fine frequency resolution, and broad frequency range the HP 8662A also meets the requirements of the most critical low noise local oscillator applications. In addition, its fast frequency switching and sweep capabilities also permit its use in many frequency agile and swept local oscillator applications.

An advanced microprocessor-based controller allows convenient keyboard control of all HP 8662A functions. For example, all functions can be incremented and decremented in any user-defined step size within the resolution of the synthesizer using the increment keys and the knob. Up to nine full front panel setups can be stored in the HP 8662A's memory and recalled for later use in any user-defined sequence at the touch of a pushbutton. This permits time-saving semi-automation of generator operation in production setups where the generator must perform many different tests.

#### Precision Digital Sweep

Fast frequency switching combined with microprocessor control gives the HP 8662A a powerful sweep capability. Automatic, single, and manual modes are available for both linear and logarithmic sweeps with user-selectable step size and number of steps. Five different sweep speeds can be chosen and up to five amplitude or Z-axis markers can be set. All sweep parameters can be controlled with full synthesizer resolution.

- 100 kHz to 2560 MHz frequency range
- AM/FM/ØM/pulse in one generator
- Internal variable modulation oscillator

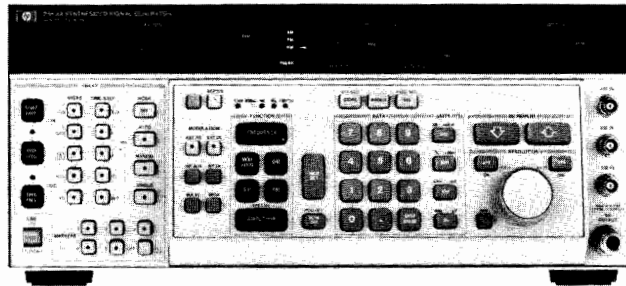

HP 8663A



### HP 8663A Synthesized Signal Generator

The HP 8663A provides all the features and the exceptional spectral purity of the HP 8662A with increased frequency range and modulation capability.

The HP 8663A also has U.S. Air Force MATE (Modular Automatic Test Equipment) system compatibility, Option 700. Option 700 is an external translator that provides the HP 8663A with the capability to be controlled by the MATE language CIIL (Control Interface Intermediate Language).

#### Broad Frequency Range

The HP 8663A utilizes the complete frequency synthesis portion of the HP 8662A with the addition of an internal frequency doubler to achieve a broad frequency range of 100 kHz to 2560 MHz in a single instrument. In the HP 8663A, the exceptional spectral purity of the HP 8662A is maintained up to 1280 MHz. Above this, phase noise is typically increased 6 dB to a level of  $-124$  dBc/Hz at 10 kHz offset from a 2.5 GHz carrier. High output power of +16 dBm (with over-range to 19.9 dBm) is available for efficiently driving frequency translators when low noise microwave signals are needed. Combined with a microwave synthesizer such as the HP 8673A, full frequency coverage from 100 kHz to 26 GHz is possible.

#### Flexible Modulation

Complete modulation capability across a wide carrier frequency range is the key contribution of the HP 8663A. AM and FM characteristics are similar to those offered in the HP 8662A. The HP 8663A adds high performance pulse and biphasic modulation with wide bandwidth linear phase modulation available with Option 002. For complete flexibility the HP 8663A Option 002 has the capability to simultaneously provide AM+FM+pulse+phase modulation across its entire frequency range. AM, FM, and linear phase are either AC or DC coupled while biphasic and pulse are DC coupled. This modulation flexibility assures exact signal simulation when testing complex systems such as those involving pulsed doppler radar and electronic warfare. An internal 100 kHz sinusoidal modulation synthesizer phase locked to the 10 MHz time base is standard. Microprocessor flexibility allows the sweep functions to be applicable to the internal audio synthesizer, as well as the RF synthesizer, making applications involving swept modulation possible with a single instrument.

#### Similarity to the HP 8662A

Because the HP 8663A has been designed to be upward compatible with the HP 8662A, the two generators have identical control and performance characteristics for those functions that are common. Either generator can be combined with the HP 11729C Microwave Converter and the HP 3048A Phase Noise Measurement System to perform microwave phase noise measurements simply and quickly.

## HP 8662A Specifications

### Frequency

**Range:** 10 kHz to 1280 MHz (1279.9999998 MHz).

**Resolution:** 0.1 Hz (0.2 Hz above 640 MHz).

**Accuracy and stability:** same as reference oscillator.

**Internal reference oscillator:** 10 MHz quartz oscillator. Aging rate  $< 5 \times 10^{-10}$ /day after 10 day warm-up (typically 24 hrs in normal operating environment).

### Spectral Purity

**Residual SSB Phase Noise in 1 Hz BW ( $320 \leq f_c < 640$  MHz)**

Offset from Carrier				
10 Hz	100 Hz	1 kHz	10 kHz	100 kHz
-100 dBc	-112 dBc	-121 dBc	-131 dBc	-132 dBc

**SSB broadband noise floor in 1 Hz BW at 3 MHz offset from carrier:**  $< -146$  dBc for  $f_c$  between 120 and 640 MHz at output levels above +10 dBm.

### Spurious Signals

	Frequency Range (MHz)				
	0.01 to 120	120 to 160	160 to 320	320 to 640	640 to 1280
Spurious non-harmonically related <sup>1,2</sup>	-90 dBc	-100 dBc	-96 dBc	-90 dBc	-84 dBc
Sub-harmonically related ( $\frac{1}{2}$ , $\frac{3f}{2}$ , etc.)	none	none	none	none	-75 <sup>3</sup> dBc
Power line (60Hz) related or microphonically generated (within 300 Hz) <sup>4</sup> .	-90 dBc	-85 dBc	-80 dBc	-75 dBc	-70 dBc
Harmonics	$< -30$ dBc				

### Output

**Level range:** +13 to -139.9 dBm (1V to 0.023  $\mu$ V<sub>rms</sub> into 50 $\Omega$ ).

**Resolution:** 0.1 dB.

**Absolute level accuracy (+15° to +45°C):**  $\pm 1$  dB between +13 and -120 dBm,  $\pm 3$  dB between -120 and -130 dBm.

**SWR:** typically from 1.5 to 1.8 depending on output level and frequency.

**Reverse power protection:** typically up to 30W or  $\pm 8$  Vdc.

### Amplitude Modulation

**Depth:** 0 to 95% at output levels of +8 dBm and below (+10 dBm in uncorrected mode). AM available above these output levels but not specified.

**Resolution:** 1%, 10 to 95% AM; 0.1%, 0 to 9.9% AM.

**Incidental PM (at 30% AM):** 0.15–640 MHz,  $< 0.12$  radian peak; 640–1280 MHz,  $< 0.09$  radian peak.

**Incidental FM (at 30% AM):** 0.15–640 MHz,  $< 0.12 \times f_{mod}$ ; 640–1280 MHz,  $< 0.09 \times f_{mod}$ .

**Indicated accuracy:**  $\pm 5\%$  of reading  $\pm 1\%$  AM. Applies for rates given in table below, internal or external mode, for depths  $\leq 90\%$ .

### Rates and Distortion with Internal or External Modulating Signal

Frequency range	AM rate	AM Distortion		
		0-30% AM	30-70% AM	70-90% AM
0.15–1 MHz	dc–1.5 kHz	2%	4%	5.75%
1–10 MHz	dc–5 kHz	2%	4%	5.75%
10–1280 MHz	dc–10 kHz	2%	4%	5.75%

### Frequency Modulation

**FM rates (1 dB bandwidth):** external ac, 20 Hz to 100 kHz; external dc, dc to 100 kHz.

**FM deviation:** from 25 to 200 kHz depending on carrier frequency.

**Indicated FM accuracy:**  $\pm 8\%$  of reading plus 10 Hz (50 Hz to 20 kHz).

**FM resolution:** 100 Hz for deviations  $< 10$  kHz, 1 kHz for deviations  $\geq 10$  kHz.

**Incidental AM (AM sidebands at 1 kHz rate and 20 kHz deviation):**  $< -72$  dBc,  $f_c < 640$  MHz;  $< -65$  dBc,  $f_c \geq 640$  MHz.

**FM distortion:**  $< 1.7\%$  for rates  $< 20$  kHz,  $< 1\%$  for rates  $< 1$  kHz.

**Center frequency accuracy and long term stability in AC mode:** same as CW mode.

### Supplemental Characteristics

**Typical Absolute and Residual SSB Phase Noise, 639 MHz Carrier.**

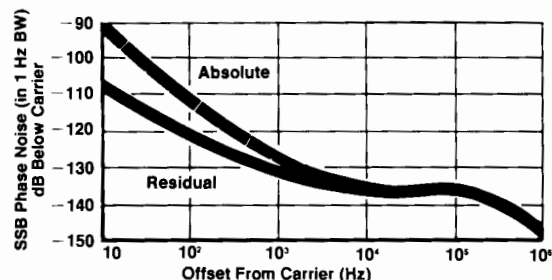

**Frequency switching speed:**<sup>5</sup> From 420  $\mu$ sec to 12.5 msec, depending on the programming mode.

## HP 8663A Specifications

The HP 8663A signal generator is related to the HP 8662A in both concept and structure. The HP 8662A concept of an extremely low phase noise signal source incorporating signal generator modulation capabilities and output characteristics is carried even further by the HP 8663A. While maintaining high spectral purity, the HP 8663A offers increased frequency range to 2560 MHz, increased output level to +16 dBm, and the addition of phase and pulse modulation. The result is a highly flexible and powerful signal generator that utilizes and extends the proven circuitry of the HP 8662A. Thus, the HP 8662A and HP 8663A share many of the same specifications as shown below:

### Frequency

**Range:** 100 kHz to 2560 MHz (2559.9999996 MHz)

**Resolution:** 0.1 Hz ( $f_c < 640$  MHz)

0.2 Hz ( $640 \text{ MHz} \leq f_c < 1280 \text{ MHz}$ )

0.4 Hz ( $f_c \geq 1280 \text{ MHz}$ )

**Accuracy, stability, and internal reference oscillator:** identical to HP 8662A.

<sup>1</sup>In the remote mode it is possible to have microprocessor clock related spurious signals spaced 3 MHz apart at an absolute level of typically less than -145 dBm.

<sup>2</sup>Spurious signals can be up to 3 dB higher in the dc FM mode.

<sup>3</sup>1/2 spurs not specified for carrier frequencies above 850 MHz.

<sup>4</sup>At a 50 Hz line frequency, power line or microphonically related spurious signals may be up to 3 dB higher and appear at offsets as high as 1 kHz from the carrier.

<sup>5</sup>Due to automatic leveling loop bandwidth changes, brief (30 msec) level inaccuracies may occur when switching through 150 kHz and 1 MHz RF output frequencies.

### Spectral Purity

**Residual SSB phase noise in 1 Hz BW ( $320 \leq f_c < 640$  MHz):** identical to HP 8662A.

**Typical SSB phase noise:** identical to the HP 8662A for  $f_c$  between 100 kHz and 1280 MHz (see graph). For  $f_c$  between 1280 and 2560 MHz, the noise will be approximately 12 dB higher than the 639 MHz curve on the "typical SSB phase noise" graph.

**Absolute SSB phase noise in a 1 Hz BW:** identical to the HP 8662A for  $f_c$  between 100 kHz and 1280 MHz. For  $f_c$  between 1280 and 2560 MHz, the specified noise is 6 dB higher than the 640 to 1280 MHz specification in the table.

**Spurious signals:** identical to HP 8662A except for  $f_c$  between 1280 and 2560 MHz the spurious non-harmonics are  $-78$  dBc, the subharmonically related ( $f/2, 3f/2$ , etc.) between 640 and 1280 MHz are  $-70$  dBc and between 1280 and 2560 MHz are  $-40$  dBc, and the power line (60 Hz) or microphonically generated spurious are  $-65$  dBc.

**Harmonics:**  $< -30$  dBc,  $\leq +13$  dBm output,  $< -25$  dBc,  $+13$  dBm to  $+16$  dBm output,  $f_c < 1280$  MHz;  $< -25$  dBc,  $f_c \geq 1280$  MHz

### Output

**Level range:**  $+16$  dBm to  $-129.9$  dBm

**Resolution:** 0.1 dB

**Absolute level accuracy ( $+15^\circ$  to  $+45^\circ\text{C}$ ):**  $\pm 1$  dB,  $+16$  dBm to  $-119.9$  dBm;  $\pm 3$  dB for  $-120$  dBm and below.

**SWR:**  $< 1.5$

### Amplitude Modulation

**Depth:** 0 to 95% at levels of  $+10$  dBm and below

**Resolution:** 0.1%

**Incidental FM (at 30% AM):** identical to HP 8662A except:  $< 0.3 \times f_{\text{mod}}$  for 1280  $\leq f_c < 2560$  MHz

**Indicated accuracy:**  $\pm 6\%$  of reading  $\pm 1\%$  AM (400 Hz and 1 kHz, depth 90%)

### AM Bandwidth (1dB):

DC to  $> 1.5$  kHz,  $0.15$  MHz  $\leq f_c < 1$  MHz; DC to  $> 5$  kHz,  $1$  MHz  $\leq f_c \leq 10$  MHz; DC to  $> 10$  kHz,  $f_c > 10$  MHz: External dc coupling. External ac coupling or internal; low frequency coupling is 20 Hz.

**Distortion (400 Hz and 1 kHz):**  $< 2\%$  (0–30% AM);  $< 4\%$  (30–70% AM);  $< 6\%$  (70–90% AM).

### Frequency Modulation

**FM rates (1 dB bandwidth):** external ac, 20 Hz to 100 kHz, external dc, dc to 100 kHz.

**Maximum allowable peak deviation:** identical to HP 8662A for  $f_c$  between 100 kHz and 1280 MHz. Up to 400 kHz for  $f_c$  between 1280 and 2560 MHz.

**Indicated FM accuracy (50 Hz to 20 kHz):**  $\pm 9\%$  of setting  $+10$  Hz.

**FM resolution:** 100 Hz to 1 kHz depending on  $f_c$  and deviation setting.

**Incidental AM (AM sidebands at 1 kHz rate and 20 kHz deviation):**  $< -72$  dBc ( $10 \leq f_c < 640$  MHz);  $< -65$  dBc ( $640 \leq f_c < 2560$  MHz).

**FM distortion:**  $< 1.25\%$  (400 Hz and 1 kHz rates);  $< 1.75\%$  (rates less than 20 kHz).

### Phase Modulation (Option 002)

**Maximum peak phase deviation:** from  $\pm 25^\circ$  for  $f_c$  between 120 and 160 MHz up to  $\pm 400^\circ$  for  $f_c$  between 1280 and 2560 MHz.

**Maximum rate:** from 10 kHz for  $f_c$  between 0.15 and 10 MHz up to 10 MHz for  $f_c$  between 250 and 2560 MHz.

**Phase deviation resolution:**  $1^\circ$  ( $0.1 \leq f_c < 640$  MHz);  $2^\circ$  ( $640 \leq f_c < 1280$  MHz);  $4^\circ$  ( $1280 \leq f_c < 2560$  MHz).

**Phase modulation distortion:** 10% at maximum rate.

### Biphase Modulation

Biphase modulation is available on the standard HP 8663A for  $f_c$  less than 640 MHz and available for all  $f_c$  with Option 002.

**Deviation:**  $\pm 90^\circ$ .

**Carrier null when modulated with 1 MHz, 50% duty cycle square wave:**  $> 25$  dBc.

**Modulation input required:** TTL positive true. The internal modulation oscillator can be used for 50% duty cycle modulation. External input is on rear panel.

### Pulse Modulation<sup>1</sup>

**Pulse on/off ratio:**  $> 80$  dB (50–2560 MHz).

**Pulse rise/fall time:**  $< 250$  ns (50–120 MHz);  $< 800$  ns (120–640 MHz);  $< 100$  ns ( $f_c \geq 640$  MHz).

**Pulse Repetition Frequency (50% duty cycle):**

Internal: 10 Hz to 99.9 kHz.

External: 10 Hz to 2 MHz,  $50$  MHz  $< f_c < 640$  MHz; 10 Hz to 5 MHz,  $f_c > 640$  MHz.

### Internal Modulation Oscillator

**Rates:** 10 Hz to 99.9 kHz.

**Frequency resolution:** 3 digits.

**Frequency accuracy:** same as reference oscillator.

**Output level (available on rear panel):** 1 volt peak into 600 $\Omega$ .

**Output impedance:** 600 $\Omega$ .

**Flatness (referenced to 1 kHz):**  $< \pm 1\%$ .

**Distortion:**  $< 1\%$ .

### Other HP 8662A and HP 8663A Information

**Remote programming:** the HP-IB interface is standard on the HP 8662A and HP 8663A signal generators. All functions controlled from the front panel with the exception of the line switch are programmable with the same accuracy and resolution as in manual mode.

**Operating temperature range:**  $0^\circ$  to  $+55^\circ\text{C}$ .

**Leakage:** meets radiated and conducted limits of MIL STD 461A methods RE02 and CE03 as well as VDE 0871.

**Power requirements:** 115 (90–126) V or 230 (198–252) V; 48 to 66 Hz; 450 VA max.

**Weight:** HP 8662A: net, 30 kg (65.5 lb.); shipping, 36 kg (80 lb.).

HP 8663A: net, 33.8 (74 lb.); shipping, 40 kg (88 lb.).

**Size:** HP 8662A: 178H x 425W x 572 mmD (7" x 16.75" x 22.5").

HP 8663A: 178H x 425W x 642 mmD (7" x 16.75" x 25.3"). Note: depth includes front panel depth of 45 mm (1.75").

### Ordering Information

	Price
<b>HP 8662A 1280 MHz Signal Generator<sup>2</sup></b>	\$38,500
Opt 001 RF connectors on rear panel only	+ \$385
Opt 003 Specified SSB phase noise for 640 MHz output	+ \$540
Opt 907 Front handle kit (5061-9690)	+ \$67
Opt 908 Rack flange kit (5061-9678)	+ \$36
Opt 909 Rack flange kit with front handles (5061-9684)	+ \$93
Opt 910 A total of two sets of operating and service manuals (08662-90069)	+ \$139
Opt W30 Extended repair service. See page 723	+ \$900
Opt W32 Calibration service. See page 723	+ \$1525
Opt 1BN Mil std 45662A calibration certificate.	+ \$200
Opt 1BP Mil std 45662A calibration with data provided	+ \$750
<b>HP 11721A External frequency doubler for operation to 2.56 GHz (HP 8662A only)</b>	\$700
<b>HP 8663A 2560 MHz Signal Generator<sup>2</sup></b>	\$53,200
Opt 001 RF connectors on rear panel only	+ \$385
Opt 002 Wideband linear phase modulation	+ \$5,670
Opt 003 Specified SSB phase noise for 640 MHz output.	+ \$540
Opt 700 External MATE translator	+ \$7,050
Opt 907 Front handle kit (5061-9690)	+ \$67
Opt 908 Rack flange kit (5061-9678)	+ \$36
Opt 909 Rack flange kit with front handles (5061-9684)	+ \$93
Opt 910 Provides an additional operation and calibration manual (08663-90069) and service manuals (08663-90071)	+ \$360
Opt 915 Add service manual (08663-90071)	+ \$155
Opt W30 Extended repair service. See page 723	+ \$1220
Opt W32 Calibration service. See page 723	+ \$1775
Opt 1BN Mil std 45662A calibration certificate	+ \$200
Opt 1BP Mil std 45662A calibration with data provided	+ \$800
<b>HP 11714A Service Support Kit (required for servicing HP 8662A/8663A)</b>	\$1,555

<sup>1</sup>Pulse modulation is available for  $f_c < 50$  MHz but is unspecified.

<sup>2</sup>HP-IB cables not supplied. For description and price, see page 579.

☎ For same-day shipment, call HP DIRECT at 800-538-8787

# SIGNAL GENERATORS

## High-Performance RF

HP 8665A and HP 8665B

- 100 kHz to 4.2 GHz (HP 8665A), to 6 GHz (HP 8665B)
- $< -134$  dBc/Hz SSB phase noise at 20 kHz offset

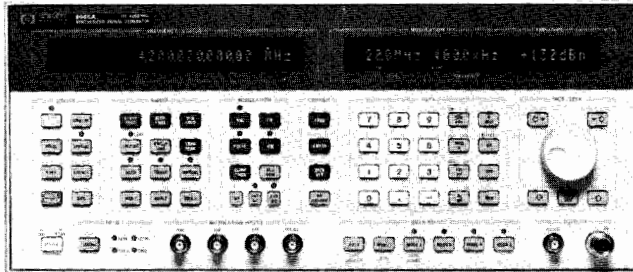

HP 8665A/B



### HP 8665A/B Synthesized Signal Generator

The HP 8665A/B Synthesized Signal Generators are high performance, programmable signal generators intended for out-of-channel RF receiver measurements, particularly receiver measurements such as spurious rejection, which often require frequency coverage to 4 GHz. A frequency range from 100 kHz to 4.2 GHz allows the HP 8665A to be used in all out-of-channel receiver measurements while a frequency range from 100 kHz to 6 GHz allows the HP 8665B to be used in applications such as surveillance radar.

#### Excellent Spectral Purity

The HP 8665A/B exhibit excellent spectral purity by having both low SSB phase noise and low spurious. Low SSB phase noise of  $< -134$  dBc/Hz at 20 kHz offset and 1 GHz carrier is for high performance characterization of receiver selectivity, while low spurious of  $< -100$  dBc is for characterization of receiver spurious rejection. This spectral purity, coupled with frequency coverage, provides a solution to measurements that often could be done only by two separate signal generators.

#### AM, FM and Optional Pulse Modulation

The HP 8665A/B offer AM, FM and optional pulse modulation across its full frequency range. FM rates of up to 2 MHz and deviations to 20 MHz peak allow use in many applications, such as telemetry, requiring higher FM performance. An optional pulse modulator with ON/OFF ratio  $> 80$  dB and rise and fall times  $< 5$  ns is offered on the HP 8665A. Pulse width and delay can be internally adjusted between 50 ns and 999 ms, eliminating the need for an external pulse generator.

#### Internal Modulation Synthesizer

The HP 8665A/B provide an internal modulation synthesizer with a frequency range from 0.1 Hz to 400 kHz. Sine, square, sawtooth and white gaussian noise waveforms are available. A second internal source, identical to the source described above, may also be selected and summed with the first source. This provides variable two-tone capability. Plus, the first source can be internally modulated with AM, FM, phase modulation, pulse modulation and double sideband modulation to further enhance this internal modulation synthesizer.

### HP 8665A/B Specifications

#### Frequency

**Range:** 100 kHz to 4200 MHz. (8665A), 100 kHz to 6000 MHz (8665B)

**Under range:** 10 kHz with uncalibrated output and modulation.

**Over range:** 4500 MHz (8665A) with uncalibrated output and modulation.

**Resolution:** 0.01 Hz.

**Accuracy and stability:** in CW, same as reference oscillator.

#### Relative Phase Adjust

**Preset:** adjustable in  $1^\circ$  increments.

**Analog:** 200 radians/volt in 515 to 1030 MHz band from an internal or external input through phase modulation input.

**Analog bandwidth:** STD mode: 150 Hz; low noise mode, Opt 004: 20 Hz.

**External input impedance:** Typically,  $50\Omega$ .

- $< -100$  dBc non-harmonic spurious
- FM rates to 2 MHz
- Optional pulse modulation

#### Internal Reference Oscillator

**Typical stability:** standard: aging rate;  $\pm 2$  ppm/year; Option 001:  $< 10^{-9}$ /day aging rate after 10 days warmup.

#### Spectral Purity

**SSB phase noise (CW, AM, or FM<sup>1</sup> operation) measured in a 1 Hz BW in dBc/Hz**

Carrier Frequency Range (MHz)	Offset Frequency					
	1 kHz		20 kHz		100 kHz	
	STD	Opt 004	STD	Opt 004	STD	Opt 004
4200 to 6000 (8665B)	-63	-83	-105	-116	-122	-121
4120 to 4200	-63	-83	-105	-116	-122	-121
3000 to 4120	-63	-89	-105	-122	-122	-127
2060 to 3000	-67	-89	-111	-122	-128	-127
1500 to 2060	-67	-94	-111	-128	-128	-133
1030 to 1500	-73	-94	-117	-128	-134	-133
750 to 1030	-73	-100	-117	-134	-134	-139
515 to 750	-79	-100	-122	-134	-138	-139
375 to 515	-79	-106	-122	-139	-138	-144
257.5 to 375	-85	-106	-128	-139	-143	-144
187.5 to 257.5	-85	-112	-128	-144	-143	-146
30 to 187.5	-73	-94	-117	-128	-132	-133
.1 to 30	-73	-100	-117	-131	-132	-134

#### Typical SSB phase noise at 1 GHz comparing STD with Low Noise Opt 004

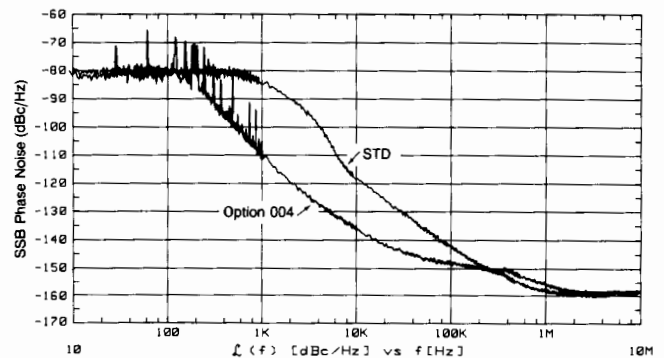

**SSB broadband noise floor:** in 1 Hz BW at  $> 1$  MHz offset from carrier with  $> 5.1$  dBm output level.

$< -145$  dBc for carrier frequencies  $> 187.5$  MHz

$< -140$  dBc for carrier frequencies  $> 10$  MHz,  $< 187.5$  MHz

#### Spurious Signals

**Harmonics:**  $< -30$  dBc, output level  $< +10$  dBm;  $< -25$  dBc, output level  $< +13$  dBm.

**Sub-harmonics:**  $< -75$  dBc, 100 kHz to  $< 1500$  MHz;  $< -40$  dBc, 1500 to  $< 3000$  MHz;  $< -50$  dBc,  $> 3000$  MHz.

**Non-harmonics:**  $< -100$  dBc,  $> 10$  kHz offset, 187.5 to 2060 MHz, STD mode and low noise mode, Opt 004;  $< -90$  dBc,  $> 10$  kHz offset, 0.1 to 187.5 MHz, STD mode and low noise mode, Opt 004;  $< -90$  dBc,  $> 10$  kHz offset,  $> 2060$  MHz, STD mode and low noise mode, Opt 004.

**Residual FM<sup>2</sup>: (CW, AM, FM Operation)**  $< 15$  Hz STD mode,  $< 2.5$  Hz low noise mode Opt 004, 750 to 1500 MHz, .3 to 3 kHz BW.

**Residual AM:**  $< 0.02\%$  AM rms, 0.3 to 3 kHz post detection bandwidth.

**SSB AM noise floor, offsets  $> 100$  kHz with AM off:**  $< -140$  dBc/Hz at  $+13$  dBm output, 0.1 to 187.5 MHz;  $< -150$  dBc/Hz at  $+13$  dBm output,  $> 187.5$  MHz.

#### Output

**Maximum level:**  $+13$  dBm,  $+9$  dBm with pulse modulation, Opt 008.

<sup>1</sup> FM at minimum deviation.

<sup>2</sup> Specified for 48 to 63 Hz power line. Typical for 400 Hz power line.

**Minimum level:** -139.9 dBm.  
**Display resolution:** 0.1 dB.  
**Absolute accuracy:** ±1 dB, output >-119.9 dBm, 0.1 to 3000 MHz; ±1.5 dB, output >-119.9 dBm, >3000 MHz.  
**Reverse power protection:** 25W into 50Ω, .1 to 2060 MHz. 1W into 50Ω, >2060 MHz.  
**Third order intermodulation:** typically, <-50 dBc with two signals at +8 dBm and 25 kHz apart, passing through a resistive combiner.  
**Output level overrange:** typically, 2 dB more than maximum level.  
**SWR:** <1.5:1, output <0 dBm; <1.75:1, output >0 dBm; 0.1 to 3000 MHz; <1.75:1, output <0 dBm, <2.0:1, output >0 dBm, >3000 MHz.

**Output impedance:** nominally 50Ω.

**Modulation**

**External modulation input:** Coupling is ac or dc for AM and FM modulation. Pulse modulation input is dc coupled. 1V peak input is required for calibrated operation in AM and FM.

**Amplitude Modulation**

**AM depth:** 0 to 99.9%, for output <+7 dBm, ≤3 dBm (Opt. 008).

**AM resolution:** 0.1%.

**AM indicator accuracy:** ±(6% of setting + 1% AM), up to 90% depth at 1 kHz rate for <3000 MHz f<sub>c</sub> and up to 70% depth ≥3000 MHz f<sub>c</sub>.

**AM distortion, at 400 Hz and 1 kHz rates:** <4% for depths 30 to 70%.

**AM 3 dB bandwidth:** >5 kHz, 1 to 10 MHz; >10 kHz, for >10 MHz carrier frequencies.

**Incidental phase modulation:** at 30% depth and 1 kHz rate. <0.2 radians peak, 0.1 to 2000 MHz f<sub>c</sub>; <0.4 radians peak, 2000 to 4200 MHz f<sub>c</sub>; <0.6 radians >4200 MHz.

**External AM input impedance:** 600Ω.

**Frequency Modulation**

**FM Deviation and Rate:**

Carrier Frequency (MHz)	Maximum Peak Deviation		
	STD Mode (kHz)	Low Noise Mode Option 004 (kHz)	Maximum Rate <sup>1</sup> (3 dB BW) (kHz)
4200 to 6000 (8665B)	20000	400	800
3000 to 4200	20000	400	800
1500 to 3000	10000	200	800
750 to 1500	5000	100	800
375 to 750	2500	50	800
187.5 to 375	1250	25	800
10 to 187.5	5000	100	800
<10	5000	100	800

**FM resolution:** 2.5% of setting.

**FM indicator accuracy:** DC to 20 kHz rates. ±9% of FM deviation setting STD mode; ±11% of FM deviation setting, low noise mode, Opt 004.

**FM distortion:** <1% for rates 20 Hz to 20 kHz.

**Carrier frequency accuracy in FM:** ±0.5% of deviation setting, ac or dc coupled.

**Incidental AM:** <0.1%, at <20 kHz deviation, 1 kHz rate.

**External FM group delay:** <30 μsec for rates <20 kHz, decreases to <1 μsec at rates above 200 kHz.

**External FM input impedance:** 600Ω.

**Pulse Modulation (Option 008)**

**On/Off ratio:** >80 dB.

**Rise/Fall time:** <5 nsec, between 10% and 90% response points.

**Pulse repetition frequency:** internal, 0.1 Hz to 400 kHz; external, DC to 10 MHz.

**Pulse width:** internally variable between 50 ns and 999 ms.

**Pulse delay:** internally variable between 50 ns and 999 ms.

**Output level accuracy:** same as with no pulse modulation.

**External input level:** TTL.

**External input impedance:** 50Ω or Schottky TTL.

**Internal Modulation Source**

**Number of sources:** Source 1, source 2, simultaneously available through summation, independently adjustable in frequency, phase, amplitude and waveform. Source 1 may also be internally modulated

<sup>1</sup> Typically the 3 dB BW is >2 MHz for deviations < maximum peak deviation/10.  
<sup>2</sup> Typical accuracy up to 20 kHz rates and maximum deviations is better than ±7%.

independently with AM, FM, phase modulation, pulse modulation and double sideband modulation.

**Waveforms:** sine, square, sawtooth and white gaussian noise.

**Frequency range:** 0.1 Hz to 400 kHz, sine and white gaussian noise. 0.1 Hz to 50 kHz, square and sawtooth.

**Frequency resolution:** 0.1 Hz.

**Frequency accuracy:** same as internal reference oscillator.

**Maximum output level:** 1 V<sub>pk</sub> into 600Ω.

**Output level resolution:** <2 mV. Typically, <1 mV.

**Output impedance:** Typically, 600Ω.

**Total harmonic distortion:** <0.1%, output at 1 V<sub>pk</sub> and <20 kHz. Typically, <.1% to 100 kHz.

**Frequency Sweep**

**Phase Continuous Sweep**

**Sweep time:** 10 msec to 10 sec.

**Maximum sweep span:** up to 40 MHz in the 3000 to 4200 MHz band.

**Digitally Stepped Sweep**

**Sweep type:** linear or log, frequency stepped.

**Sweep time range:** 500 msec to 100 sec. Typical time per step is 90 msec.

**X-Axis output:** nominal 0 to +10V.

**Z-Axis output:** nominal +5V during retrace.

**Markers available:** 3.

**Remote Programming**

**Interface:** HP-IB (Hewlett-Packard's implementation of IEEE-488.2-1987). HP-IB select code range: 00 to 30. Interface function is listener and talker.

**Control language:** Hewlett-Packard Systems Language (HP-SL).

**Functions controlled:** all front panel functions except power switch and knob.

**HP-IB functions:** SH1, AH1, T6, TE0, L4, LE0, SR1, RL1, PP0, DC1, DT0, C0, E2.

**General**

**Power requirements:** ±10% of 100, 120, 220, or 240V; 48 to 440 Hz; 500 VA maximum.

**Operating temperature range:** 0 to +55°C.

**Leakage:** Conducted and radiated interference meets MIL STD 461B RE02 and FTZ 1046. RF leakage is typically 1 μV below 1 GHz f<sub>c</sub>, induced in a two-turn loop antenna 2.5 cm in diameter held 2.5 cm away from the front panel for output levels <0 dBm. Option 010 reduces RF leakage to typically <0.5 μV.

**Calibration interval:** 3 years (MTBC).

**Storage registers:** 10 full function and 40 frequency/amplitude registers.

**Memory erasure:** All memory contents, except generic calibration data, can be erased according to Mil Std 380-380.

**Weight:** net, approx. 29 to 31 kg (63 to 69 lb); shipping, 40 to 42 kg (88 to 94 lb) depending on the options ordered.

**Size:** approx. 178H x 425W x 648 mmD (7" x 16.75" x 25.5"). Opt 010 adds 35 mm (1.4") to the depth.

**Ordering Information**

HP 8665A Synthesized Signal Generator<sup>3</sup> \$36,000

HP 8665B Synthesized Signal Generator<sup>3</sup> \$38,000

Opt 001 High stability time base (includes EFC) \$1,550

Opt 003 RF inputs on rear panel only +\$400

Opt 004 Low noise mode +\$4,100

Opt 008 Pulse modulation +\$3,600

Opt 010 Reduced leakage configuration +\$1,500

Opt 907 Front handle kit (5061-9690) +\$65

Opt 908 Rack flange kit (5061-9678) +\$35

Opt 909 Rack flange kit (5061-9684) with front handles +\$90

Opt 910 Provides an additional operation and calibration manual (08665-90026) and two service manuals (08645-90024) +\$190

Opt 915 Add service manual (08645-90024) +\$65

Opt W30 Extended repair service. See page 723. +\$835

08665-61116 Service kit \$500

9211-2662 Transit case \$550

1490-0913 Transit case wheels \$210

1494-0059 Non-tilting rack slide kit \$100

1494-0063 Tilting rack slide kit \$190

<sup>3</sup> HPIB cables not supplied. For description and price, see page 579.

☎ For same-day shipment, call HP Direct at 800-538-8787

# SIGNAL GENERATORS

## CW Microwave

### HP 8671B

- 2 to 18 GHz frequency range
- +8 dBm calibrated output power
- Low spurious signals

- Low phase noise
- 128 dB dynamic range
- 1 to 3 kHz frequency resolution



HP 8671B

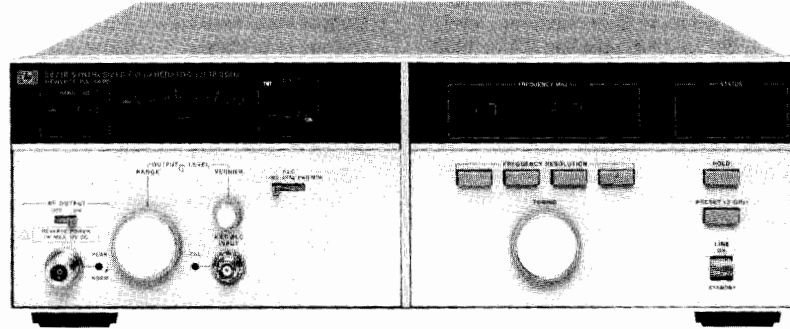

### HP 8671B Synthesized CW Generator

The HP 8671B is an economy 2.0 to 18.0 GHz synthesized CW generator. It meets all the requirements for a clean CW source. It features synthesized output with 1, 2 or 3 kHz resolution, 128 dB dynamic range, +8 dBm calibrated output power, full programmability, low phase noise and low spurious signals.

#### General-Purpose Measurements

For applications requiring a microwave local oscillator, the HP 8671B is the ideal solution. A simple, uncluttered, easy to use generator, the HP 8671B provides accurate, clean signals to upconvert and downconvert signals into the desired measurement frequency range.

The +8 dBm output capability (with plenty of reserve) is just what you need to drive mixers. You can now take full advantage of the entire 2.0 to 18.0 GHz frequency range from a single instrument. The HP 8671B provides broadband synthesizer capability for the price of a non-synthesized source.

As a microwave source for downconversion, important measurements like noise figure and modulation analysis become more affordable. The HP 8671B with an external mixer allows you to make these measurements at an IF with the HP 8970B Noise Figure Meter and the HP 8901A/B and HP 8902A Modulation Analyzers. Other downconverted measurements may include network, spectrum, and waveform analysis.

#### ATE Systems

The +8 dBm output capability of the HP 8671B provides the extra margin you need for automated systems. Higher power at the source means sufficient power at the unit under test, even after losses through cables and switches. For automated systems, the requirements for low phase noise, low spurious signals, and precise frequency settability are easily accommodated by the HP 8671B.

### HP 8671B Specifications

#### Frequency Characteristics

**Range:** 2.0–18.0 GHz (18.6 GHz overrange).

**Resolution:** 2.0 to 6.2 GHz: 1 kHz  
6.2 to 12.4 GHz: 2 kHz  
12.4 to 18.0 GHz: 3 kHz

**Time base:** internal 10 MHz ( $<5 \times 10^{-10}$ /day aging rate) or external 5 or 10 MHz.

**Frequency switching time:** <15 ms to be within specified resolution, all bands.

#### Spectral Purity

##### Single-sideband phase noise (1 Hz BW, CW mode):

F <sub>c</sub>	Offset from F <sub>c</sub>				
	10 Hz	100 Hz	1 kHz	10 kHz	100 kHz
Band 1	-58 dBc	-70 dBc	-78 dBc	-86 dBc	-110 dBc
Band 2	-52 dBc	-64 dBc	-72 dBc	-80 dBc	-104 dBc
Band 3	-48 dBc	-60 dBc	-68 dBc	-76 dBc	-100 dBc

**Harmonics (up to maximum frequency, output level meter readings <0 dB on 0 dBm range and below):** <-25 dBc.

**Sub-harmonics and multiples thereof:** <-25 dBc.

#### Spurious

**Non-harmonically related:** <-70 dBc, Band 1; <-64 dBc, Band 2; <-60 dBc, Band 3.

**Power line related and fan rotation related within 5 Hz below line frequency and multiples thereof:**

F <sub>c</sub>	Offset from F <sub>c</sub>		
	<300 Hz	300 Hz to 1 kHz	>1 kHz
Band 1	-50 dBc	-60 dBc	-65 dBc
Band 2	-44 dBc	-54 dBc	-59 dBc
Band 3	-40 dBc	-50 dBc	-55 dBc

#### Output Characteristics

**Output level (+15°C to +35°C):** +8 to -120 dBm

**Flatness (0 dBm range, +15°C to +35°C):** ±0.75 dB, Band 1, ±1.00 dB, Band 2, ±1.25 dB, Band 3.

**Output level switching time:** <20 ms, internally leveled  
<10 ms, typical within one output level range

#### Remote Operation

**Frequency:** Programmable over full range with same resolution as manual mode

**Output Level:** Programmable in 1 dB steps

**RF:** Choice of either ON or OFF

**ALC:** Choice of either internal leveling, diode leveling, or power meter leveling

#### Interface functions:

SH1, AH1, T6, TE0, L4, LE0, SR1, RL0, PP2, DC1, DT0, C0, E1.

#### General

**Operating temperature range:** 0°C to +55°C.

**Power:** 100, 120, 220, 240 V, +5%, -10%, 48-66 Hz; 300 VA max.

**Weight:** net, 27 kg (60 lb). Shipping, 32.5 kg (72 lb).

**Size:** 133 mm H x 425 mm W x 603 mm D (5.25" x 16.75" x 23.75").

#### Ordering Information

HP 8671B Synthesized CW Generator

Opt 907 Front panel handle kit

Opt 908 Rack mounting flange kit

Opt 909 Front panel handle kit plus rack mounting flange kit

Opt 910 Extra operating and service manual

Opt W30 Extended repair service. See page 723.

#### Price

\$24,240

+\$55

+\$33

+\$80

+\$60

+\$600



- 2 - 26 GHz frequency range
- +8 dBm calibrated output power
- Digital sweep

- Frequency extension capability to 110 GHz
- Low phase noise
- Low spurious signals

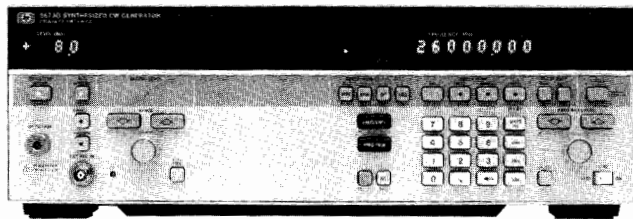

8673G

## HP 8673G Synthesized CW Generator

### Exceptional Value in a CW Generator

The HP 8673G is the world's lowest priced 2.0 - 26.0 GHz synthesized CW generator. Satisfying all the requirements for a clean CW source, it features the same excellent spectral purity, output range, mm-drive capability, digital sweep, and HP-IB programmability featured in all of the HP 8673 family. The HP 8673G is the ideal CW generator for local oscillator, up/down conversion, and exciter applications to 26 GHz. Because the HP 8673G has full HP-IB compatibility, you can use your existing software proven for other HP 8673 series synthesizers.

### Economy and Measurement Flexibility

Not only is the HP 8673G the most economical CW synthesizer to 26 GHz, it provides outstanding measurement flexibility. For up or down conversion applications, harmonics less than -40 dBc and low phase noise provide you with plenty of dynamic range. To ensure sufficient power in ATE systems, the HP 8673G with Option 008 gives you +10 dBm of leveled output power (for typical output power see graph on page 396) from 8 to 26 GHz. When making component measurements, the synthesized sweep capability of the HP 8673G and the power of HP-IB programmability allows you to make quick swept measurements of your device under test with synthesizer accuracy.

## HP 8673G Specifications

### Frequency Extension to 110 GHz

The HP 8673G is one of the lowest-cost methods to achieve millimeter-wave frequencies. It can be used with the HP 83550-series millimeter wave source modules and the HP 8349B Microwave Amplifier to provide leveled output signals at the output of the source module up to 110 GHz. With System mode, the resultant output frequency can be displayed on the HP 8673G front panel by entering the multiplication factor of the source module.

### Frequency Characteristics

**Range:** 2.0 - 26.0 GHz

**Resolution:** 2.0 - 6.6 GHz: 1 kHz  
 6.6 - 12.3 GHz: 2 kHz  
 12.3 - 18.6 GHz: 3 kHz  
 18.6 - 26.0 GHz: 4 kHz

### Spectral Purity

**Single-sideband phase noise (1 Hz BW, 1 kHz offset, CW mode):**

F <sub>c</sub>	Offset from F <sub>c</sub>				
	10 Hz	100 Hz	1 kHz	10 kHz	100 kHz
Band 1	-58 dBc	-70 dBc	-78 dBc	-86 dBc	-110 dBc
Band 2	-52 dBc	-64 dBc	-72 dBc	-80 dBc	-104 dBc
Band 3	-48 dBc	-60 dBc	-68 dBc	-76 dBc	-100 dBc
Band 4	-46 dBc	-58 dBc	-66 dBc	-74 dBc	-98 dBc

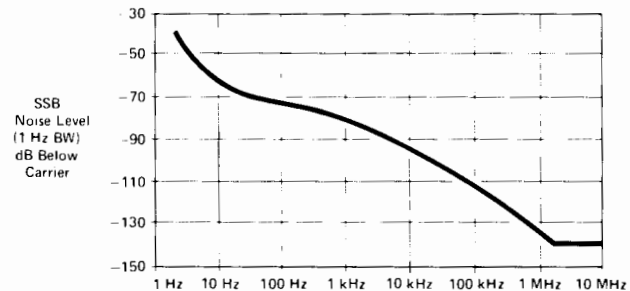

Typical HP 8673G single-sideband phase noise performance using the internal standard, Band 1.

**Harmonics (<0 dBm; +15° C to +35° C):** <-40 dBc

**Subharmonics and multiples thereof:** 2.0 - 18.6 GHz: <-25 dBc, 18.6 - 26 GHz: <-20 dBc

**Spurious (non-harmonically related):** 2.0 - 18.6 GHz: <-60 dBc, 18.6 - 26.0 GHz: <-58 dBc

**Spurious (power line and fan rotation related):** 2.0 - 18.6 GHz: <-40 dBc, 18.6 - 26.0 GHz: <-38 dBc

### Output Characteristics

**Output Level:** 2.0 - 18.0 GHz: +8 dBm, 18.0 - 22.0 GHz: +4 dBm, 22.0 - 26.0 GHz: +1 dBm

**With Opt 008:** 2.0 - 8.0 GHz: +8 dBm, 8.0 - 26.0 GHz: +10 dBm

**Resolution:** 0.1 dB

### General

**Digital Sweep Characteristics:** Identical to HP 8673B

**Remote Programming:** All functions HP-IB programmable except line switch

**Operating temperature range:** 0 to +55°C

**Power:** 100, 120, 220, 240V, +5%, -10%; 48-66 Hz; 400 VA max

**Weight:** net, 29kg (64lb); shipping, 34.5kg (76lb)

**Size:** 146H x 425W x 620mmD (5.7" x 16.8" x 24.4")

### Ordering Information

	<b>Price</b>
<b>HP 8673G Synthesized CW Generator</b>	<b>\$29,290</b>
<b>Opt 004</b> Rear panel RF output	+\$75
<b>Opt 006</b> Chassis slide kit	+\$75
<b>Opt 008</b> +10 dBm output power	+\$5,000
<b>Opt 907</b> Front panel handle kit	+\$55
<b>Opt 908</b> Rack mounting flange kit	+\$33
<b>Opt 909</b> Front panel & rack mounting kits	+\$80
<b>Opt 910</b> Service manual and extra operating manual	+\$80
<b>Opt 915</b> Service manual	+\$65
<b>Opt W30</b> Extended Repair Service. See page 723.	+\$725

# SIGNAL GENERATORS

## Economy Microwave HP 8673H

- 2 to 12.4 GHz or 5.4 to 18 GHz
- +8 to -100 dBm calibrated output
- 0.1 dB resolution, digitally displayed

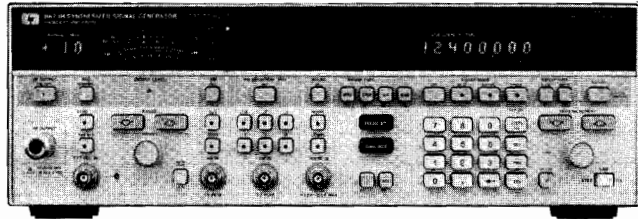

8673H



### HP 8673H Multiband Synthesized Signal Generator

#### Low Price, High-Performance

When full 2.0 to 26.0 GHz frequency coverage is not needed, you can choose the HP 8673H Synthesized Signal Generator with the same reliability and performance at nearly half the cost of a 2 to 26 GHz synthesizer. Choose between option 212 (2 to 12.4 GHz) and option 618 (5.4 to 18.0 GHz) for the frequency coverage you need. What does high performance mean? Standard on either option of the HP 8673H is AM, FM, and pulse modulation, digital sweep, millimeter-drive capability and +8 dBm output power.

#### Multiband Frequency Coverage for Multiple Applications

Whether your application is receiver test, component test, or frequency translation, the HP 8673H has the performance you need. For pulsed sensitivity testing of radar receivers, you can be confident that pulse shape fidelity will be maintained under all specified output power levels and pulse widths. Leveled output power to -100 dBm provides great dynamic range for sensitivity testing. Digital sweep and high output power make swept frequency component tests simple and easy. The HP 8673H allows measurement flexibility with variable sweep dwell and span. Low phase noise and wide FM deviations to 10 MHz allow for accurate signal substitution in communication systems. With the addition of the HP 83550 millimeter source modules, the HP 8673H gives you the capability to reach 110 GHz.

#### Drop-in Confidence

The HP 8673H is ideal for automated test systems. Minimum output power of +8 dBm (see typical output power graph on page 396) means sufficient power at the device under test even after losses through switches and cables. For systems that have proven software for an HP 8673 synthesizer, the HP 8673H is a drop-in replacement.

#### Reliability You Can Count On

Acquisition cost is an important factor in any purchase decision. But what about cost-of-ownership? As a member of the field-proven HP 8673 family, the HP 8673H comes to you with an estimated 20,000 hours mean time between failure (based on component warranty failure rates). To guarantee that the first three years of your HP 8673H are worry-free, option W30 provides three years of return-to-HP service.

### HP 8673H Specifications

#### Frequency Characteristics

**Range:** 2.0–12.4 GHz (Option 212)  
5.4–18.0 GHz (Option 618)  
**Resolution:** 2.0–6.6 GHz: 1 kHz  
6.6–12.3 GHz: 2 kHz  
12.3–18.0 GHz: 3 kHz

- AM/FM/Pulse Modulation
- Low spurious and phase noise
- Digital sweep

#### Spectral Purity

##### Single-sideband phase noise (1 Hz BW, 1 kHz offset, CW mode):

F <sub>c</sub>	Offset from F <sub>c</sub>				
	10 Hz	100 Hz	1 kHz	10 kHz	100 kHz
Band 1	-58 dBc	-70 dBc	-78 dBc	-86 dBc	-110 dBc
Band 2	-52 dBc	-64 dBc	-72 dBc	-80 dBc	-104 dBc
Band 3	-48 dBc	-60 dBc	-68 dBc	-76 dBc	-100 dBc

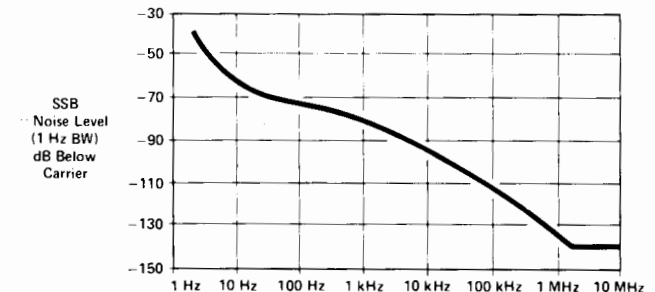

Typical HP 8673H single-sideband phase noise performance using the internal standard, Band 1.

**Harmonics (< 0 dBm; +15°C to +35°C):** < -40 dBc  
**Subharmonics and multiples thereof:** ≤ -25 dBc

#### Output Characteristics

**Output level (+15°C to +35°C):** +8 to -100 dBm  
**Resolution:** 0.1 dB

#### Pulse Modulation

**ON/OFF ratio:** >80 dB  
**Rise/fall times:** <50 ns, typical  
**Pulse repetition frequency:** 50 Hz to 1 MHz  
**Minimum duty cycle:** <0.0001 for leveled performance

#### Amplitude Modulation

**Depth:** 0 to 75%, at 0 dBm maximum carrier level, +15°C to +35°C.  
**Rate (30% depth):** 10 Hz to 100 kHz, ±3 dB  
**Sensitivity:** 30%/Volt and 100%/Volt ranges

#### Frequency Modulation

Deviation Range	Rate (±3 dB BW, typical)	Maximum Peak Deviation
30, 100 kHz/V	100 Hz - 10 MHz	The smaller of 10 MHz or: fmod x 5, Band 1
0.3, 1.3 MHz/V	1 kHz - 10 MHz	fmod x 10, Band 2
10 MHz/V	1 kHz - 10 MHz	fmod x 15, Band 3

#### General

**Digital sweep characteristics:** Identical to HP 8673B  
**Remote programming:** All functions HP-IB programmable except line switch.  
**Operating temperature range:** 0 to +55C  
**Power:** 100, 120, 220, 240V, +5%, -10%: 48–66 Hz; 400 VA max  
**Weight:** net, 29kg (64lb); shipping, 34.5kg (76 lb)  
**Size:** 146 H x 425 W x 620 mm D (5.7" x 16" x 24.4")

#### Ordering Information

HP 8673H Synthesized Signal Generator	Price
Opt 212 or Option 618	\$23,230
Opt 004 Rear panel RF output	+\$75
Opt 006 Chassis slide kit	+\$75
Opt 907 Front panel handle kit	+\$55
Opt 908 Rack mounting flange kit	+\$33
Opt 909 Front panel & rack mounting kits	+\$80
Opt 915 Service manual	+\$65
Opt 916 Extra operating manual	+\$20
Opt W30 Extended Repair Service. See page 723.	+\$575

# SIGNAL GENERATORS

## Synthesized Sweepers 10 MHz - 50 GHz (or 110 GHz)

### HP 8360 Series

395

- 1 Hz frequency resolution (option 008)
- Low spurious and phase noise
- 1  $\mu$ s leveled pulse width capability
- +20 dBm to -110 dBm calibrated output

- Complete analog sweeper
- dc to 250 kHz amplitude modulation
- < -50 dBc harmonics

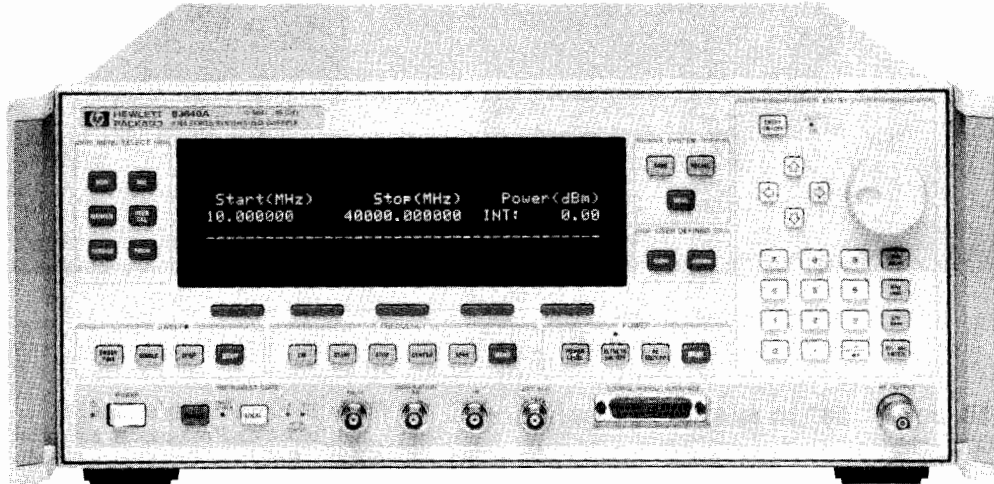

DESIGNED FOR  
**HP-IB**  
SYSTEMS  
HP 83640A

### HP 8360 Series Synthesized Sweepers

The HP 8360 series synthesized sweepers are the standard of excellence for applications requiring the high performance and accuracy of a synthesized source and the speed and versatility of a sweep oscillator. The HP 8360 series synthesized sweepers offer the same commitment to quality and reliability that is inherent in the previous industry standard HP 8340/8341.

### Frequency Precision and Spectral Purity

The synthesized broadband frequency coverage and the precise 1 Hz frequency resolution (option 008) are generated by indirect synthesis, enabling the HP 8360 to achieve the same low single-sideband phase noise performance as the HP 8340/8341, HP 8671B, HP 8672A, and HP 8673 series synthesized signal generators.

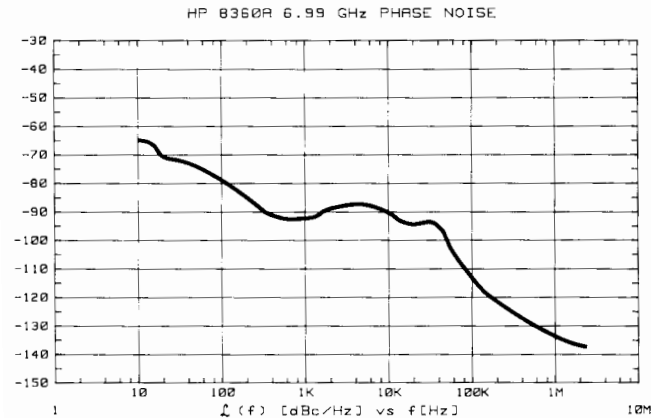

HP 8360A Phase Noise performance from 2.3 to 8.0 GHz

### Stepped CW Switching Times

The HP 8360 features list and stepped frequency switching times as fast as 5 ms. Additionally, the HP 8360 provides arbitrary CW switching times less than 50 ms.

### Output Power

The HP 8360 provides high output power ranging between +20 and -110 dBm with 0.02 dB resolution and feature power sweep capability with >20 dB dynamic range for complete characterization of level-sensitive devices.

### Pulse, Amplitude and Frequency Modulation

The HP 8360 has high-performance pulse modulators with >80 dB on/off ratio, and rise/fall times <10 ns (option 006).

The HP 8360 also features dc-coupled amplitude modulation capability with a 3 dB bandwidth of 250 kHz, and a 99.7% modulation depth. Pulse and amplitude modulation capabilities can be used simultaneously.

The HP 8360 also offers dc-coupled frequency modulation capability with rates up to 8 MHz.

### < -50 dBc Harmonics

The HP 8360 delivers excellent harmonic performance with harmonics at least 50 dB below the carrier from 1.8 to 20 GHz.

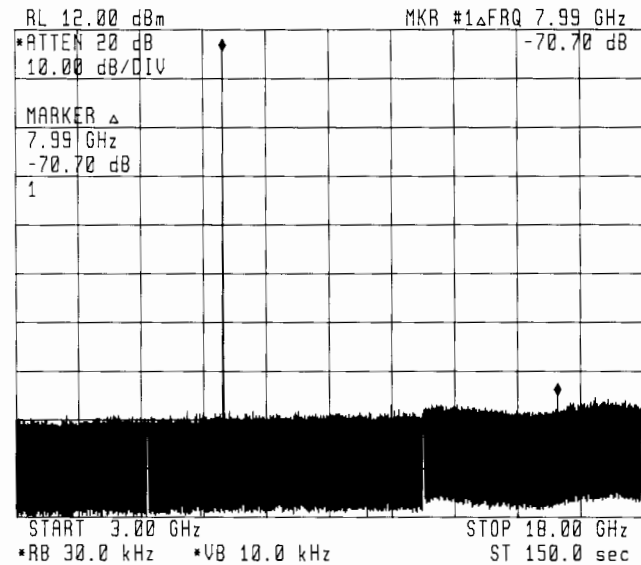

Harmonic Performance of the HP 83620A

For additional performance and ordering information about the HP 8360 series synthesized sweepers, refer to page 412.

# SIGNAL GENERATORS

## High Performance Microwave

HP 8673B, 8673C, 8673D, 8673E

- 10 MHz to 26.5 GHz frequency range
- $< -60$  dBc harmonics/subharmonics
- Low spurious and phase noise

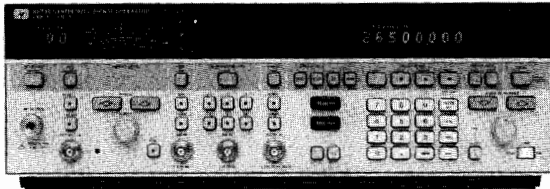

HP 8673B



### HP 8673B, 8673C, 8673D and 8673E Synthesized Signal Generators

The HP 8673B/C/D/E Synthesized Signal Generators are full performance synthesizers designed to generate precise microwave signals over the 50 MHz to 26.5 GHz frequency range. These generators offer calibrated and leveled power, AM, FM, pulse modulation, digital sweep, programmability, and frequency extension capability to 110 GHz. The HP 8673B covers 2.0 to 26.5 GHz. The HP 8673C/D pair cover 50 MHz to 18.6 GHz and 26.5 GHz respectively and the HP 8673E covers 2.0 to 18.6 GHz..

#### Excellent Spectral Purity

A variety of applications ranging from microwave radar to communications systems require the frequency stability available from the HP 8673B/C/D/E. The broadband frequency coverage is derived from multiplying a fundamental 2.0 to 6.6 GHz YIG-tuned oscillator. This technique provides the wide frequency coverage in a single instrument. Indirect synthesis phase-locks the YIG-tuned oscillator to a 10 MHz quartz crystal reference to provide excellent long term and short term stability (frequency drift  $< 5 \times 10^{-10}$  per day), (HP 8673B/C/D). Phase locked loops are optimized for lowest possible single-sideband phase noise. The HP 8673C and HP 8673D include an internal tracking YIG-filter to further reduce unwanted harmonic, subharmonic, and nonharmonic spurious signals above 1.2 GHz to  $< -60$  dBc.

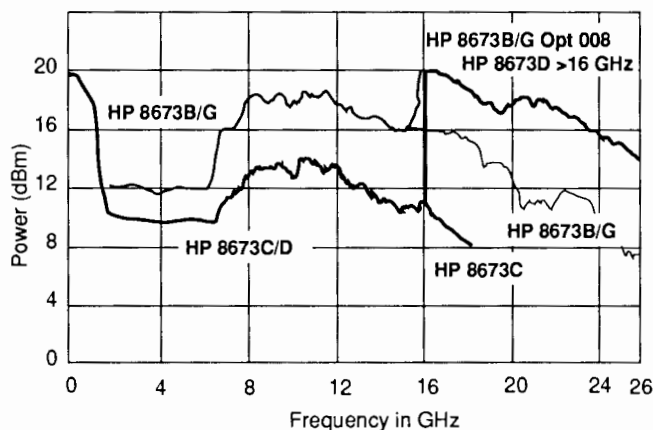
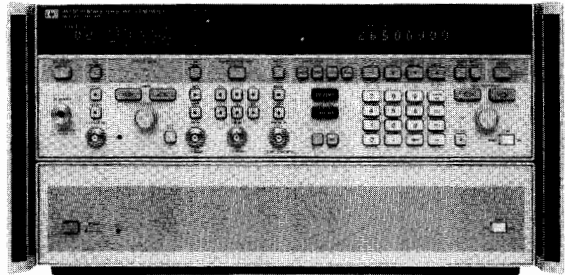

Figure 1. Maximum power typically available from HP 8673B/C/D/G and HP 8673B/G Option 008 at 25°C. HP 8673E and HP 8673H Option 212 and Option 618 typical maximum power is the same as HP 8673B/G over 2.0 to 18.0 GHz.

- +8 to  $-100$  dBm calibrated output
- Internally leveled AM/FM/pulse modulation
- Frequency extension capability to 110 GHz



HP 8673D



#### Wide Dynamic Output Range

For broadband component and receiver testing applications, the HP 8673B/C/D/E deliver exceptionally flat power output across the full frequency ranges. For receiver sensitivity measurements, power is internally (or externally) leveled to  $-100$  dBm ( $-120$  dBm for the HP 8673E). Maximum available power varies with frequency as shown in Figure 1.

#### Internally Leveled Pulse Modulation

The HP 8673B/C/D/E features an internal pulse modulator that provides high-quality pulse modulation over the entire 50 MHz - 26.5 GHz range. Since the modulation is done before the frequency multiplication, the peak pulsed power can be leveled and calibrated to within typically  $+1.5/-1.0$  dBm of the set level referenced to CW. External TTL level pulse rates up to 1 MHz and pulse widths as narrow as 100 ns can be easily accommodated by the HP 8673B/C/D/E to provide ON/OFF ratios in excess of 80 dB.

#### Calibrated AM/FM Modulation

AM and FM capability is included in the HP 8673B/C/D/E to expand the versatility in receiver testing applications. AM depth at rates up to 100 kHz can be accurately set using the front panel meter. Six ranges of metered FM are available at rates and peak deviations up to 10 MHz. The HP 8673E features unlocked mode which allows up to 10 MHz deviation at rates as low as 50 Hz. Both AM depth and FM deviation are linearly controlled by varying the externally supplied modulating input voltage up to 1V peak. Simultaneous modulation of AM, FM, and pulse is possible to simulate complex environments.

#### Frequency Extension to 110 GHz

The HP 8673B/C/D can be used as microwave drivers for the HP 83550-series millimeter-wave source modules. This combination (with the addition of the HP 8349B Microwave Amplifier) can provide leveled output signals up to 110 GHz with the "System Leveling" mode. The resultant output frequency can be displayed on the HP 8673B/C/D front panel by entering the multiplication factor of the source module.

#### Full Programmability and Digital Sweep

The HP 8673B/C/D/E provides full programmability of all front panel functions for automatic test applications. Output level can be controlled in steps as fine as 0.1 dB. An internal microprocessor is used to simplify HP-IB program code generation and follow front-panel keystroke sequences. This design allows the implementation of digital sweep. Sweep spans can be set over the entire frequency range with variable rates, step sizes, and selectable markers available.

### HP 8673B/C/D/E Specifications

#### Frequency Characteristics

**Frequency Range:** HP 8673B: 2.0–26.0 GHz (1.95 to 26.5 GHz in overrange).

HP 8673C: 0.05–18.6 GHz (0.01–18.6 GHz in overrange).

HP 8673D: 0.05–26.0 GHz (0.01–26.5 GHz in overrange).

HP 8673E: 2.0–18.0 GHz (1.95 to 18.6 GHz in overrange).

**Frequency Bands:** Band 0: 0.05–2.0 GHz

Band 1: 2.0–6.6 GHz

Band 2: 6.6–12.3 GHz

Band 3: 12.3–18.6 GHz

Band 4: 18.6–26.0 GHz

**Frequency Resolution:** 1 kHz Band 0 and 1      3 kHz Band 3  
2 kHz Band 2      4 kHz Band 4

**Time base:** internal 10 MHz ( $<5 \times 10^{-10}$ /day aging rate for HP 8673 B/C/D,  $<1.5 \times 10^{-9}$ /day aging rate for HP 8673E) or external 5 or 10 MHz.

#### Spectral Purity

**Single-sideband phase noise (HP 8673B/C/D) (1 Hz BW, CW mode):**

F <sub>c</sub>	Offset from F <sub>c</sub>				
	10 Hz	100 Hz	1 kHz	10 kHz	100 kHz
Band 0	-64 dBc	-70 dBc	-78 dBc	-86 dBc	-105 dBc
Band 1	-58 dBc	-70 dBc	-78 dBc	-86 dBc	-110 dBc
Band 2	-52 dBc	-64 dBc	-72 dBc	-80 dBc	-104 dBc
Band 3	-48 dBc	-60 dBc	-68 dBc	-76 dBc	-100 dBc
Band 4	-46 dBc	-58 dBc	-66 dBc	-74 dBc	-98 dBc

**Single-sideband phase noise (HP 8673E) (1Hz BW, 1kHz offset, CW mode):**  $<-60$  dBc

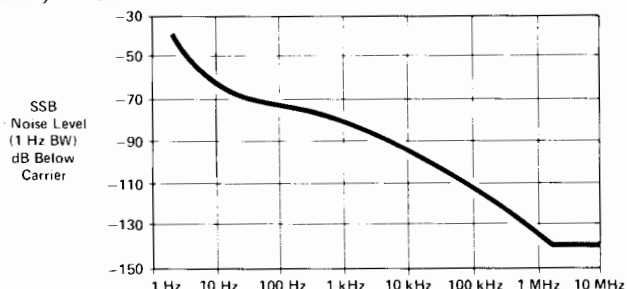

Figure 2. Typical HP 8673B/C/D/E single-sideband phase noise performance using the internal standard, Band 1.

**Harmonics (up to maximum frequency, output level meter readings  $<0$  dB on 0 dBm range and below):**  $<-40$  dBc (HP 8673B/E).

$<-35$  dBc, 50MHz–1.2GHz;  $<-60$  dBc, 1.2–26.0 GHz (HP 8673C/D).

**Sub-harmonics and multiples thereof:**  $<-60$  dBc (HP 8673C/D).

$<-25$  dBc, Bands 1–3;  $<-20$  dBc, Band 4 (HP 8673B);  $<-35$  dBc, (HP 8673E).

#### Spurious (CW and AM modes)

**Non-harmonically related:**  $<-60$  dBc, Band 0;  $<-70$  dBc, Band 1;  $<-64$  dBc, Band 2;  $<-60$  dBc, Band 3;  $<-58$  dBc, Band 4 (HP 8673B/C/D);  $<-60$  dBc (HP 8673E)

#### Output Characteristics

**Output level (+15°C to +35°C):**

8673B		8673C		8673D	
Level (dBm)	Freq. (GHz)	Level (dBm)	Freq. (GHz)	Level (dBm)	Freq. (GHz)
+8 to -100	2-18	+11 to -100	.05-2.0	+11 to -100	.05-2.0
+4 to -100	18-22	+5 to -100	2-16	+5 to -100	2-16
0 to -100	22-26	+2 to -100	16-18.6	+10 to -100	16-26

**Output level (+15°C to +35°C):** +8 dBm to -120 dBm (HP 8673E)

**Remote programming output level resolution:** 0.1 dB.

#### Pulse Modulation

**ON/OFF ratio:**  $>80$  dB (HP 8673B/C/D.)  $>70$ dB (HP 8673E)

**Rise/fall times:**  $<30$  ns, Band 0;  $<40$  ns, Bands 1–4 (HP 8673 B/C/D);  $<50$  ns (HP 8673E)

**Minimum leveled pulse width:**  $<100$  ns.

**Pulse repetition frequency:** 50 Hz - 1 MHz.

**Minimum Duty Cycle:**  $<0.001$  for leveled performance.

#### Amplitude Modulation

**Rates (3 dB BW, 30% depth):** 20 Hz-100 kHz. (HP 8673 B/C/D); 10Hz-50kHz (HP 8673E).

**Sensitivity:** 30%/V, 100%/V ranges. Max. input 1 V peak into 600 Ω.

#### Frequency Modulation (8673B/C/D)

Deviation Range	Rate ( $\pm 3$ dB BW, typical)
30, 100 kHz/V	100 Hz - 10 MHz
.3, 1, 3 MHz/V	1 kHz - 10 MHz
10 MHz/V	1 kHz - 10 MHz

**Maximum Peak Deviation**  
The smaller of 10 MHz or:  
fmod x 5, Band 0 and Band 1  
fmod x 10, Band 2  
fmod x 15, Band 3  
fmod x 20, Band 4

#### Frequency Modulation (8673E)

Deviation Range	Rate ( $\pm 3$ dB BW, typical)
30, 100 kHz/V	100 Hz - 2 MHz
.3, 1, 3 MHz/V	3 kHz - 2 MHz
10 MHz/V (unlocked)	50 Hz - 2 MHz, typical

**Maximum Peak Deviation**  
The smaller of 3 MHz or:  
fmod x 5, Band 1  
fmod x 10, Band 2  
fmod x 15, Band 3  
10 MHz

#### Digital Sweep Characteristics

**Sweep function:** start/stop or  $\Delta F$  (span) sweep.

**Sweep modes:** manual, auto, or single sweep.

**Step size:** maximum of 9999 frequency points per sweep; minimum step size equals frequency resolution.

**Dwell time:** set from 1 to 255 ms per frequency.

**Markers:** 5 independent, settable frequency markers.

**Sweep outputs:** 0 to +10 V ramp start to stop; 0.5 V/GHz ramp; Z-axis blanking/markers; tone marker; penlift.

#### Remote Programming

All functions HP-IB programmable except line switch.

#### Interface functions:

SH1, AH1, T5, TE0, L3, LE0, SR1, RL1, PP1, DC1, DT1, C0, E1.

#### General

**Operating temperature range:** 0°C to +55°C.

**Power:** 100, 120, 220, 240 V, +5%, -10%, 48-66 Hz; 400 VA max. (HP 8673B/E), 500 VA max. (HP 8673C/D)

**Weight:** HP 8673B/E: net 29 kg (64 lb); shipping 34.5 kg (76 lb).

HP 8673C/D: net 42.4 kg (94 lb.); shipping 46.5 kg (103 lb).

**Size:** HP 8673B/E: 146 mm x 425 mm x 620 mm (5.7" x 16.8" x 24.4") HxWxD. HP 8673C/D: 234 mm x 425 mm x 620 mm (9.2" x 16.8" x 24.4") HxWxD.

#### Ordering Information

**HP 8673B Synthesized Signal Generator** **Price \$42,420**

**Option 001:** Delete RF output attenuator - \$600

**Option 002:** Delete reference oscillator - \$735

**Option 004:** Rear panel RF output + \$75

**Option 006:** Chassis slide kit + \$75

**Option 008:** +10 dBm output level + \$7,000

**Option 907:** Front panel handle kit + \$55

**Option 908:** Rack mounting flange kit + \$33

**Option 909:** Combination of Opt. 907 plus 908 + \$80

**Option 910:** Extra operating and service manual + \$65

**Option W30:** Two additional years of return-to-HP warranty. See page 723. + \$1050

**HP 8673C Synthesized Signal Generator** **\$53,530**

**Options 001, 002, 004, and 006:** same as HP 8673B

**Option 908:** Rack mounting flange kit + \$55

**Option 910:** Service and extra operating manual + \$85

**Option 913:** Rack flanges for standard front handles + \$45

**Option 915:** Service manual + \$20

**Option 916:** Extra operating manual + \$65

**Option W30:** Two additional years of return to HP warranty. See page 723. + \$1170

**HP 8673D Synthesized Signal Generator** **\$57,570**

**Options 001, 002, 004, 006, 908, 913, 910, 915, and 916:** Same as HP 8673C

**Option W30:** Two additional years of return to HP warranty. See page 723. + \$1250

**HP 8673E Synthesized Signal Generator** **\$39,390**

**Options 001, 002, 004, 006, 907, 908, 909 and 910:** Same as HP 8673B

**Option W30:** Two additional years of return-to-HP warranty + \$915

**HP 11726A Support Kit (for HP 8673B)** **\$1,800**

# SIGNAL GENERATORS

## Frequency Agile/Complex Signal Simulation

### HP 8645A

- 252 kHz to 1030 MHz frequency range with optional coverage to 2060 MHz
- 15  $\mu$ s frequency switching
- Stand alone control of frequency agility

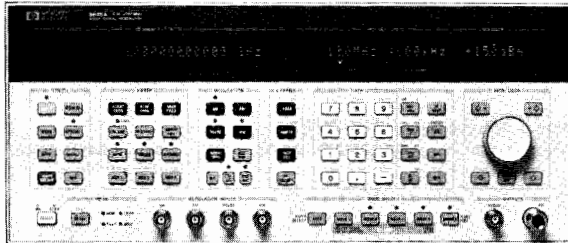

HP 8645A



Supported by  
**HP ITG**  
Software

### HP 8645A Agile Signal Generator

The HP 8645A Agile Signal Generator combines high performance with frequency agility for new fast-switching test requirements. These capabilities are important for performance testing of such devices as frequency agile radios and surveillance receivers. Besides extending traditional receiver testing to agile applications, the HP 8645A can be used to create complex signal simulations involving several modulation types and frequency agility. These complex RF signals can quantitatively exercise a receiver's vulnerability to a jamming transmission. The HP 8645A can also be a fast-switching stimulus needed to decrease production test times. The high performance and frequency agility of the HP 8645A provide capability for both static and agile test requirements with just one calibrated signal generator.

#### Specified Agile Performance

The HP 8645A provides specified signal performance in both static and agile operation. Fully-synthesized outputs with high timebase accuracy are standard when not frequency hopping. The Fast Hop mode activates a frequency-lock loop to allow frequency switching as fast as 15  $\mu$ sec from 128 to 2060 MHz. Over the frequency range of 8 to 2060 MHz, the fastest switching time is 85  $\mu$ sec and outputs below 8 MHz require 500  $\mu$ sec. Frequency accuracy of each output is better than  $\pm 2$  ppm while in Fast Hop mode. At each frequency, a specific amplitude can be assigned within a 20 dB range for performance tests versus amplitude while frequency hopping. For a full test of a receiver, up to 8000 frequencies can be entered and sequences of up to 8000 frequency settings can be specified. Performance parameters such as phase noise, spurious, amplitude accuracy, and modulation remain high quality and are completely specified while fast hopping to insure confident test results.

#### Flexible, High Performance Modulation

For receiver measurements the HP 8645A offers independent or simultaneous FM and AM for both static and hopped frequency tests. The modulating signal can be the internal 0.1 Hz to 400 kHz synthesizer or an external input that allows FM deviations up to 20 MHz at rates up to 10 MHz. In Fast Hop operation, maximum deviation is 3.5 MHz with 10 MHz rates. AM is available with up to 100 kHz rates and 99% depth. Pulse modulation allows a 35 dB on/off ratio with 100 nsec rise/fall times.

#### Complete Control of Frequency Hopping

The HP 8645A offers flexible and comprehensive control of the frequency hopping output. Parameters can be entered from the front panel, through the HP-IB port or using TTL inputs on the rear panel. Extensive hopped frequency simulations including hop frequencies, amplitude, dwell times, hop rate, modulation, etc. can be entered into non-volatile memory from the front panel. Activating a hop sequence requires only a press of the Hop key. Agile control is available by a computer with the added advantage of using the new Hewlett-Packard Systems Language (HP-SL). For real-time control, rear panel inputs accept TTL signals for triggering, dwell time and frequency selection to allow direct connection with the hardware under

- Specified performance while fast hopping
- FM rates to 10 MHz, deviations to 20 MHz
- Low spurious and phase noise

test. With this wide choice of control, use of the HP 8645A can be readily customized to a wide variety of test situations from benchtop use to ATE systems.

### HP 8645A Specifications

#### Frequency

**Range:** 251.46485 kHz to 1030 MHz; 251.46485 kHz to 2060 MHz with Option 002 or with HP 11845A 2 GHz Retrofit Kit installed.

**Frequency bands:** The exact endpoints of each frequency band can be determined by dividing the 1030 to 2060 MHz band by two for each band decrease. The specifications use approximate endpoints.

**Phase offset:** adjustable in 1 degree increments.

**Reference oscillator stability, Option 001:**  $< 5 \times 10^{-10}$ /day aging.

#### Fast Hop Operation

**Frequency switching time:** 128 to 2060 MHz:  $< 15 \mu$ sec, 8 to 2060 MHz:  $< 85 \mu$ sec, 0.25 to 2060 MHz:  $< 500 \mu$ sec. Opt. 002: add 5  $\mu$ sec.

**Frequency hop range:** 0.25 to 2060 MHz. With FM on, limited to any three consecutive frequency bands.

**Frequency accuracy<sup>1</sup>:**  $\pm 2$  ppm of carrier frequency.

**Amplitude accuracy:**  $\pm 1$  dB,  $> -127$  dBm output.

( $\pm 1.5$  dB,  $> -127$  dBm output when amplitude level is varied up to  $-5$  dB from the constant learned value during Fast Hop.)

**Channel and sequence tables:** In Fast Hop, each specific frequency and amplitude to be output is entered into a Channel Table. The order of channels to be output is entered into a Sequence Table.

**Maximum number of channels:** 8000.

**Maximum number of channels in Sequence Table:** 8000.

**Hop rate range:** fixed rates from 8 Hz to 50 kHz using internal timer. An external input allows more range and variable rates.

**Dwell time range:** fixed times of 6.4  $\mu$ sec to 99 msec using the internal timer. External input allows longer and variable dwell.

**Learn cycle time:** typically, 10 sec. to 3.5 min., depending on sequence size.

**Fast Hop bus:** allows real-time selection of any channel for output. Typically, frequency switching time increases by 5  $\mu$ sec.

**Modulation:** internal or external AM, FM, or simultaneous AM/FM.

**Output level:** Allowed amplitude variation of all channels entered is 0 to 20 dB. Output level is reduced by  $> 60$  dB while switching between channels. External dc AM can be used to shape the output.

#### Spectral Purity

##### SSB phase noise (CW, AM, or FM<sup>2</sup> operation):

Carrier Frequency (MHz)	Standard Operation		Fast Hop 20 kHz (dBc/Hz)
	20 kHz (dBc/Hz)	100 kHz (dBc/Hz)	
1030 to 2060	-120	-127	-116
515 to 1030	-127	-134	-123
257 to 515	-132	-137	-128
128 to 257	-136	-140	-133
64 to 128	-139	-141	-137
32 to 64	-141	-141	-139
16 to 32	-142	-142	-141
8 to 16	-143	-143	-142
4 to 8	-144	-144	-143
Less than 4 MHz	-144	-144	-144

**Harmonics:**  $< -30$  dBc, output  $\leq 10$  dBm. Opt. 002, output  $> 8$  dBm:  $< -30$  dBc, 0.25 to 1030 MHz;  $< -25$  dBc, 1030 to 2060 MHz.

**Subharmonics:** none,  $< 515$  MHz.  $< -60$  dBc, 515 to 1030 MHz.  $< -40$  dBc,  $> 1030$  to 2060 MHz.

**Nonharmonics:**  $> 20$  kHz offset<sup>3</sup>:  $< -100$  dBc,  $< 2060$  MHz.  $< -94$  dBc,  $> 1030$  to 2060 MHz.

<sup>1</sup>Typically,  $+2$  ppm of carrier frequency multiplied by the temperature change in  $^{\circ}$ C must be added if ambient temperature changes occur between the learn operation and the conclusion of frequency hopping. FM at minimum deviation.

<sup>2</sup>FM at minimum deviation.

<sup>3</sup>Typically, nonharmonic spurs at all offsets are  $< 30$  dB above the instrument's phase noise level as measured in a 1 Hz bandwidth.

**Residual FM<sup>1</sup> (CW, AM, FM<sup>2</sup> operation):**

Carrier frequency (MHz)	Post detection bandwidth	
	0.3 to 3 kHz (Hz rms)	0.05 to 15 kHz (Hz rms)
0.25 to 257	<1	<1.2
257 to 515	<1.2	<2
515 to 1030	<2	<4
1030 to 2060	<4	<8

**Typical SSB phase noise and spurs at 1 GHz:**

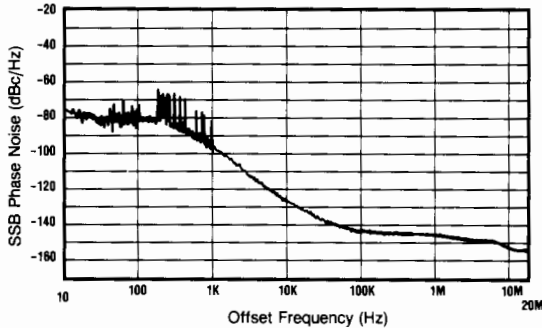

**Residual AM:** <0.01% AM rms, 0.3 to 3 kHz post detection BW.  
**Typical SSB AM noise floor, offsets >100 kHz:** <-157 dBc/Hz at +16 dBm output, 0.25 to 1030 MHz. <-150 dBc/Hz at +13 dBm output, 1030 to 2060 MHz.

**Output**

**Maximum level:** +16 dBm, 0.25 to 1030 MHz; Opt. 002: +14 dBm, 0.25 to 1030 MHz. +13 dBm, above 1030 MHz.  
**Minimum level:** -137 dBm.  
**Absolute accuracy:** ±1 dB, output ≥ -127 dBm.  
**Reverse power protection:** 50 watts from a 50Ω source, 25 Vdc.  
**Typical third order intermodulation:** <-50 dBc, outputs <8 dBm.  
**Typical output level overrange:** 2 dB more than maximum level.  
**Typical SWR and output impedance:** <1.7:1, 50Ω.

**Modulation**

**External modulation input:** Coupling is ac or dc for AM, FM and phase modulation. Pulse modulation input is dc coupled. Displayed deviation or depth corresponds to ±1V external input.  
**Simultaneous modulation:** AM/FM, AM/Phase, AM/Pulse, FM/Pulse, Phase/Pulse, AM/FM/Pulse, AM/Phase/Pulse.  
**Simultaneous internal/external modulation:** FM and Phase.

**Amplitude Modulation**

**Depth:** 0 to 99.9%, for output <±7 dBm.  
**AM indicator accuracy:** ±(6% of setting + 2%, AM), up to 90% depth and 1kHz rate for carrier frequencies >1 MHz. When amplitude level is varied up to -5 dB from the constant learned value during Fast Hop: ±(7% of setting + 1% AM) up to 80% depth, 1 kHz rate.)

**Distortion, at 400 Hz and 1 kHz rates:**

Depth	Carrier frequency	
	0.25 to 1030 MHz	1030 to 2060 MHz
0 to 30%	<2%	<5%
30 to 70%	<3%	<5%
70 to 90%	<5%	<8%

**3 dB bandwidth<sup>3</sup>:** >5 kHz, 0.25 to 8 MHz. >50 kHz, 8 to 128 MHz. >100 kHz, 128 to 2060 MHz.

**Incidental phase modulation:** <0.2 rad peak, at 30% depth and 1 kHz.

**Typical external input impedance:** 600Ω.

**Frequency Modulation**

**FM deviation and rate:** In the highest frequency band of 1030 to 2060 MHz, the maximum FM peak deviation is 20 MHz for standard operation and 3.52 MHz for Fast Hop. Maximum FM rate (3 dB bandwidth) in the 515 to 1030 MHz band and above is 10 MHz. Divide rate and deviation by two for each frequency band decrease.

**FM indicator accuracy<sup>4</sup>:** ±10%, <50 kHz rate and <10% of maximum deviation (<50% of maximum deviation in Fast Hop.)

**FM distortion:** Rates 20 Hz to 100 kHz: <2.7%, deviation <2% of maximum available (Fast Hop: <10% of maximum deviation.)

**Carrier frequency accuracy in FM:** ±0.4% of deviation setting, ac or dc coupled. Typically add 1% of deviation in Fast Hop.

**Incidental AM:** <0.5%, deviation limited to <6% of max. or 20 kHz.

**Typical external FM group delay:** 30 μs for rates 20 Hz to 20 kHz, decreases to <1 μs at rates >200 kHz. Fast Hop: <1 μs.

**Typical external FM input impedance:** 50 or 600Ω.

**Pulse Modulation**

**On/off ratio:** >35 dB.  
**Rise/fall time:** <100 nsec, between 10% and 90% response points.  
**Maximum pulse repetition frequency:** 1 MHz.  
**Minimum pulse width:** 0.5 μs.

**Typical output level accuracy:** ±2 dB.  
**Typical external input levels and impedance:** on: >3.0V peak; off: <0.8V peak. Damage level: ≥±10V peak. 600Ω.

**Internal Modulation Source**

**Waveforms:** sine, square, sawtooth and white Gaussian noise.  
**Frequency range:** sine, white Gaussian noise: 0.1 Hz to 400 kHz. Square, sawtooth: 0.1 Hz to 50 kHz.

**Frequency accuracy:** same as internal reference oscillator.  
**Output level:** Typically, 1 V<sub>pk</sub> max. into 600Ω. Accuracy: ±20 mV.  
**Output level resolution:** 2 mV. Typical impedance: 600Ω.

**Distortion:** <0.1%, output at 1V peak and ≤15 kHz.

**Frequency Sweep**

**Phase continuous sweep:** linear sweep with times from 10 ms to 10 s, not dependent on span. Maximum span is 40 MHz from 1030 to 2060 MHz frequency band, divided by two for each band decrease.

**Fast Hop sweep:** linear or log stepped with times from 10 msec to 100 sec. Number of steps varies with time selected. Typical time per step is 30 μs for outputs within 128 to 2060 MHz, 170 μs for 8 to 2060 MHz, and 650 μs for 0.25 to 2060 MHz.

**Sweep control and markers:** X-axis: 0 to +10V. Z-axis: +5V retrace, +1V trace, 0V markers. Three markers available.

**General**

**Remote control:** HP-IB (IEEE-488.2-1987). The control language used is the Hewlett-Packard Systems Language (HP-SL). All front panel functions except power switch and knob. A unique Fast Hop bus interface accepts TTL levels for frequency agile control.

**Operating temperature range:** 0 to +55° F.  
**Leakage:** meets Mil Std 461B RE02 and FTZ 1046.

**Storage registers:** 10 full function and 40 freq./ampl. locations.  
**Memory erasure:** all memory contents according to Mil Std 380-380.

**Weight:** net, 31 kg (69 lbs); shipping, 42 kg (95 lbs).  
**Size:** 177H x 426W x 624mmD (7" x 16.8" x 24.6").

**Ordering Information**

<b>HP 8645A Agile Signal Generator<sup>4</sup></b>	<b>Price</b>
Opt 001 High stability time base	\$32,900
Opt 002 2 GHz output	+ \$1,550
Opt 003 RF connectors on rear panel only	+ \$7,150
Opt 907 Front handle kit (5061-9690)	+ \$400
Opt 908 Rack flange kit (5061-9678)	+ \$65
Opt 909 Rack flange kit with front handles (5061-9684)	+ \$35
Opt 910 Provides an additional operation/calibration manual (08645-90023) and 2 service manuals (08645-90025)	+ \$90
Opt 915 Add service manual (08645-90025)	+ \$190
Opt W30 Extended repair service. See page 723	+ \$65
<b>HP 11845A 2 GHz Retrofit Kit</b>	+ \$800
<b>08645-61116 Service kit</b>	\$6,180
<b>9211-2662 Transit case</b>	\$500
<b>1490-0913 Transit case wheels</b>	\$550
<b>1494-0059 Non-tilting rack slide kit</b>	\$210
<b>1494-0063 Tilting rack slide kit</b>	\$100
<b>4HP-1B cables not included. For description and price, see page 579.</b>	\$190

<sup>1</sup>Specified for 48 to 63 Hz power line. Typical for 400 Hz power line and Fast Hop operation.

<sup>2</sup>Deviation <0.1% of maximum available.

<sup>3</sup>Lower 3 dB bandwidth limit is 0 Hz for dc coupling and typically 20 Hz for ac coupling.

☎ For same-day shipment, call HP Direct at 800-538-8787

# SIGNAL GENERATORS

## Frequency Agile/Complex Signal Simulation

### HP 8770S, 8770A, 11776A

- A new source of "real-life" signals to 50MHz
- A software reconfigurable modulation source
- Simulate very complex baseband and IF signals
- Excellent spectral purity



#### HP 8770S Signal Simulator System, dc - 50 MHz

##### Simulate Signals for Radar, EW, Communications, Magnetic Disk and Other Applications

Today's sophisticated electronic systems require "real-life" functional testing to ensure that they will perform properly under their intended operating conditions. The HP 8770S helps you answer critical questions: "Will this radar accurately detect and decode multiple targets? Will my EW receiver correctly identify advanced threats? Will this digital communication receiver properly reconstruct transmitted signals in the presence of fading or jamming? Will this magnetic disk read circuits respond properly to a missing bit?"

##### Description

The HP 8770S Signal Simulator System consists of the:

- HP 8770A Arbitrary Waveform Synthesizer
- HP 9000 Series 300 Technical Computer
- HP 11776A Waveform Generation Software.

Design waveforms with the software, then generate the waveforms with the HP 8770A. Use this advanced simulation system to generate complex baseband and IF signals from dc to 50 MHz. Add precise amounts of distortion and noise to test the operating margins of your system early in the development cycle. All signal parameters are under complete software control, allowing quick changes to meet new test demands. The HP 8770A has a complete HP-IB command set for full automatic control and easy downloading of waveform data previously defined by the HP 11776A or by other means. Regardless of your application, the use of precise complex test signals improves the evaluation of your circuits and systems.

The HP 8770A Arbitrary Waveform Synthesizer (AWS) forms the heart of the HP 8770S. Advanced digital synthesis techniques ensure precise waveform generation.

##### Features

- 8 ns sample update rate
- 12-bit words
- 125 MHz internal clock (phase-locks to crystal osc.)
- Special "deglitching" circuits
- 110 dB RF attenuator
- 512K memory

##### Benefits

- Rapid signal parameter changes
- High amplitude resolution
- Time base with synthesizer accuracy
- Low harmonic and spurious distortion levels
- 12-bit resolution even at low signal levels
- Highly complex waveforms, Longer waveform sequences

- Outstanding reliability (> 100,000 hrs MTBF)
- 125MHz sample rate
- 12-bit resolution, 512K word memory

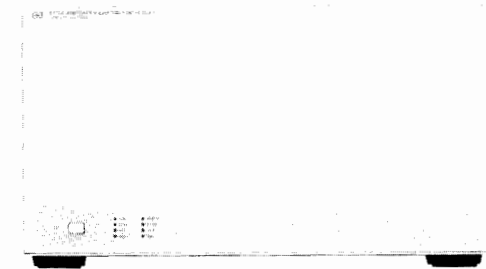

DESIGNED FOR  
**HP-IB**  
SYSTEMS  
HP 8770A

The HP 11776A Waveform Generation Software operates on the HP 9000 Series 300 technical computers. It consists of the Waveform Generation Language (WGL), an HP BASIC 5.13 operating system, and application disks for powerful waveform development. Use over 100 easy commands and math functions to create and manipulate waveforms as desired. Add noise or spurs to generate real-life test signals. Add waveforms together to create harmonically distorted waves, or multiply waves to create complex modulated signals. Create waves in either the frequency or time domain and quickly convert from one to the other. Capture data from other instruments such as spectrum analyzers and oscilloscopes. Once waveforms have been developed, you can download them into the HP 8770A for immediate generation or store them on a disk for later use in multiple stations. Thus, WGL makes "what if" testing to determine a device's performance easy and affordable.

##### Build Waveform Libraries for Complete Tests

Any HP-IB computer can control the HP 8770A and download previously defined waveform data. Generate a library of test waveforms with the HP 11776A software or your own BASIC program. Then download them to the HP 8770A from the computer in your ATE system for use in your applications.

##### Stretch Memory with Sequencing

Certain parts of waveforms often repeat themselves and quickly fill up even the largest memory. This leaves less memory to define the rest of the desired test signal. The HP 8770A avoids this problem by allowing sections of memory (packets) to be repeated any number of times and in any order. This sequencing capability and the large 512K word memory free large amounts of memory for greater flexibility when defining complex waves. Many test signals can also be stored simultaneously in the memory and accessed at any time with the sequencer. In a production ATE environment, this substantially decreases download time, reducing costs.

##### Applications Overview

###### Radar

The HP 8770S simulates multiple targets for more effective radar testing. Simulate complex radar video and IF signals. Add noise, pulse jitter, and clutter. Shape radar chirps to exact specifications. Stagger multiple radar pulses. Vary the PRF as a function of time. Control radar pulse parameters with extremely precise resolution. Finally, manipulate doppler shift and range or superimpose multiple targets together, resulting in complex, demanding test signals.



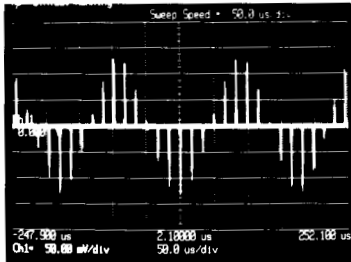

Doppler shifted return of moving target

### Electronic Warfare

Simulate MOP, exotic threats, and other complex modulated signals to test next-generation EW receivers and signal processors. Vary pulse amplitudes, rise and fall times, pulse width, PRI, and stagger, of individual radars.

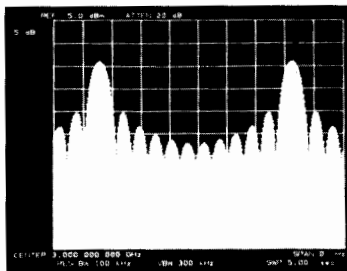

Antenna scan pattern

### Communications

The HP 8770S is an excellent signal simulator for conventional analog communication systems, digital microwave radios, and satellite communications systems. Design and generate amplitude-, frequency-, and phase-modulated communications signals with digital precision. Exploit memory sequencing to hop from one frequency to the next with fast frequency switching speed and phase continuity. Simulate Nyquist filter responses in software to eliminate time-consuming and costly hardware filters.

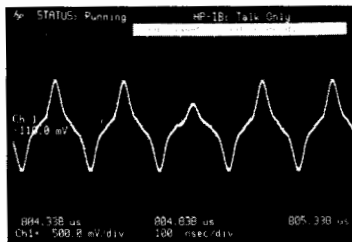

Missing bit

### Magnetic Disk

The signal simulation system continues to be extremely successful in magnetic disk applications. Replace the head disk assembly to test read/servo channel boards for design integrity, calibrate disk media certifiers, or verify board operation in production test. Test bit shift susceptibility to less than 50ps shift resolution. The Programmer's Starter Kit (P/N 08770-60064) interactively creates seven common disk-test waveforms.

### Other Applications

- Video and Imaging
- Component Test

### HP 8770A Performance Characteristics

#### Frequency

**Range:** dc to 50 MHz

**Frequency Switching Speed:** 8 ns, phase continuous

#### RF output

**Power range:** +10 dBm to -110 dBm

**Attenuator:** 110 dB in 10 dB steps

**Max Output Voltage:** 2 V p-p into 50 or 75 ohms

**Number of DAC bits:** 12 true bits, monotonic

- Amplitude Resolution:** .024% of full scale
- Amplitude Flatness:**  $< \pm 0.65$  dB ( $< 0.1$  dB w/predistortion)
- Phase Linearity (dc - 50MHz):**  $\pm 5^\circ$  ( $< \pm 1^\circ$  w/predistortion)
- Output Impedance:** 50  $\Omega$  (75  $\Omega$  for option 002)
- Output SWR:**  $< 1.2:1$
- Connector:** Type N (female)

### Spectral Purity

**Harmonic Distortion (output level = +10dBm):**

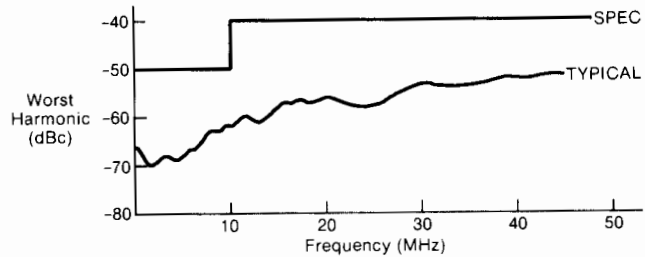

### Inband Spurious and Nonharmonic Distortion:

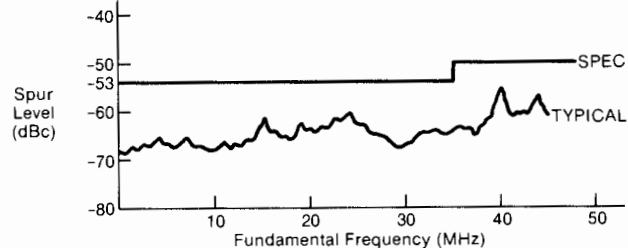

**Two-Tone Intermodulation Distortion:**  $< -65$  dBc for a 10.000 MHz and 10.124 MHz signal at +4 dBm each.

**SSB Phase Noise @10MHz:**  $< -120$  dBc/Hz @ 10kHz offset.

### Modulation Capabilities

AM, FM,  $\Phi$ M, Chirp, Pulse, Digital (BPSK, QPSK, BPSK, QAM), Antenna Scan, I/Q.

**External System Triggering:** Repetitive, Single-Shot, Gated;

**Outputs:** Scan Start, Packet Start, Sequence Start, Equal Address, Packet Advance Ready.

**Inputs:** Packet Advance Trigger, System Start Trigger, System Stop Trigger.

### Clock

**Sampling Clock Rate:** 125 MHz (externally variable)

**Reference Oscillator:** 10 MHz quartz crystal. Aging rate  $< 5 \times 10^{-10}$ /day after a 24 hour warmup and an oscillator time-off of less than 24 hours.

### Remote Operation

HP-IB, 16-bit GPIO parallel port

### General

**Operating Temperature:** 15-40 C

**Power:** 445 VA

**Weight:** Net, 23.6 kg (52 lb), Shipping, 29.5 kg (65 lb)

**Size:** 235 H x 425.5 W x 622 mm D (9.25" x 16.75" x 24.5")

### Ordering Information

HP 8770S Signal Simulator System

**Price**

\$0

To ensure coordination of shipments and compatibility of instruments, computers and software, use the system model number when ordering individual components. Obtain the HP 8770A and HP 11776A Data Sheet and an HP 8770S Ordering Guide from your local sales office.

HP 8770A Arbitrary Waveform Synthesizer

\$25,000

**Option 002:** 75 ohm Output Impedance

\$0

**Option H12:** Digital Data Output

\$500

HP 11776A Waveform Generation Software (5.25" Diskettes Standard)

\$6,500

**Option 630:** 3.5" Diskettes Only

\$0

HP P/N 08770-60064 Programmer Starter Kit

\$75



## Modes of Operation

### Instruments on a Disk (IDs)

Instruments-on-a-Disk (IDs) make this otherwise complex system easy to use and give FASS the front panel personality of specific applications. By clicking clearly labeled softkeys with the mouse, users can select sophisticated signal characteristics like PRI stagger and antenna scan patterns.

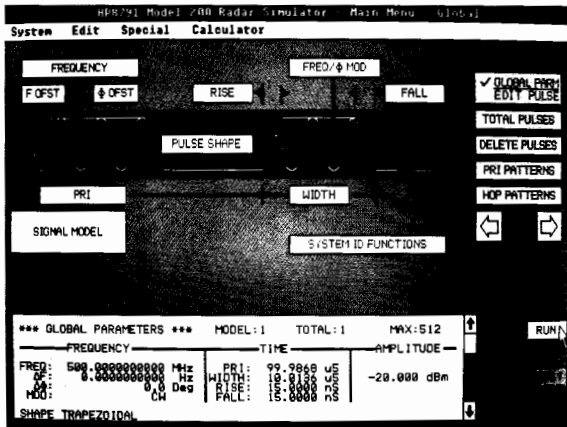

HP 8791 Model 200 screen

### Remote HP-IB

Remote HP-IB commands in FASS come in two varieties. There are the commands that simply mimic front-panel key strokes of an Instrument-on-a-Disk and the general-purpose commands that give access to all the functions of FASS. Whichever set of standard HP-IB commands are used, integrating FASS's high-integrity, advanced signal simulation capability into an existing simulation system is very convenient.

### Waveform Generation Language (WGL)

For advanced applications where existing Instrument-on-a-Disk software is insufficient, users can program FASS with the Waveform Generation Language (WGL) software. WGL could be used to generate a non-standard signal such as a non-linear chirp or a pulse with droop.

### Dynamic Data

Dynamic data mode allows selective, external control of instantaneous frequency, FM,  $\Phi$ M and AM, as well as pulse modulation and level. In dynamic data mode, data maps are downloaded to the modulation data source's frequency and modulation memories. Dynamic data supplied at rates of up to 33 MHz addresses desired locations in memory. The output of FASS is determined by the values mapped at that location.

## Performance Characteristics

### HP 8791 Model 11 Frequency Agile Signal Simulators

#### Frequency

**Range:** 0.01 to 3 GHz (to 18.5 GHz with upconversion)

**Resolution:** 0.125 Hz

**Switching speed:** < 250 ns over full 3 GHz BW

#### Amplitude

**Fast level control switching speed:** < 250 ns in 6.02 dB steps

**Output power:** +10 to -107 dBm

#### Modulation capabilities

**Instantaneous bandwidth:** 40 MHz

**Formats:** Arbitrary FM,  $\Phi$ M, AM, Pulse, Frequency Hopping

#### Spectral purity

**Spurious response:** -55 dBc, typical

**Phase noise:** < -125 dBc/Hz @ 10 kHz offset, 2 GHz, typical

#### Remote Operation

HP-IB compatible

**Dynamic data:** AM, FM,  $\Phi$ M, carrier frequency, pulse

**Dynamic data rates:** Up to 33 megawords/sec/channel

#### General

**Dimensions:** rack 1237H x 600W x 803mmD (48.7" x 23.6" x 31.6") consol 1064H x 754W x 756mmD (41.9" x 29.7" x 29.8")

**Weight:** shipping, rack 295kg (650lb); consol 75kg (165lb)

### HP 8791 Model 100 Precision Signal Generator

The HP 8791 Model 100 Precision Signal Generator Instrument-on-a-Disk (PSID) software configures HP 8791 Model 11 FASS to be a precise signal generator with the modulation capabilities of an advanced waveform generator.

**Carrier:** Amplitude, phase, frequency

**AM:** Modulation index: 0 to 9999% (80 dB DSB-SC)

Modulation frequency: 0.0625 Hz to 20 MHz

**PM:** Peak phase deviation: 0° to 180°

Modulation frequency: 0.0625 Hz to 10 MHz

(upper limit dictated by 40 MHz modulation bandwidth)

**FM:** Frequency deviation: 0.125 Hz to 20 MHz

Modulation frequency: 0.0625 Hz to 10 MHz

(upper limit dictated by 40 MHz modulation bandwidth)

**Modulation Waveforms:** Sine: AM, PM, FM

Rectangle: 0 to 100% duty cycle AM (allows for pulse modulation)

Arbitrary user-defined:  $\leq$  8192 points

### HP 8791 Model 200 Radar Simulator

The Model 200 Radar Simulator Instrument-on-a-Disk (RSID) software configures HP 8791 Model 11 FASS to simulate advanced pulsed radar emitters.

**Frequency hopping:** constant, linear, scheduled, user-defined

**Intrapulse modulation:** coherent, non-coherent, chirp, Barker, user-defined

**Pulse width:** 29.8 ns to 100 ms

**Rise and fall:** 29.8 ns to 230 us

**Pulse shapes:** trapezoidal, Gaussian, exponential, user-defined

**Pulse repetition frequency:** 1 Hz to 625 kHz

**PRF patterns:** constant, burst, stagger, jitter, wobulation, user-defined

**Antenna scan rate:** 4 to 100,000 RPM

**Main beam width:** 0.1 to 360°

**Antenna scan patterns:** circular, conical, raster, sector, user-defined

**Antenna radiation patterns:** rectangular, Hamming, Hanning, Blackman, 3-term, cosn, programmable

## Vector Arbitrary Waveform Synthesizer

### Simulation of Complex Wideband Signals with I/Q Modulation

The Vector Arbitrary Waveform Synthesizer (VAWS) is a customer-configured system that simulates extremely complex signals. It allows functional testing of non-agile communications, radar and EW systems and subsystems. Two HP 8770A arbitrary waveform generators provide the complex modulating signals for the I and Q modulation inputs of an HP 8780A Vector Signal Generator. Because I/Q or vector modulation is used, the signal can be completely defined in terms of phase, magnitude, and frequency. The modulation can be arbitrarily defined, and the effects of actual hardware and environment on a signal can be simulated. For many simulator applications, the Frequency Agile Signal Simulator is the instrument of choice. However, for applications requiring modulation bandwidth greater than 40 MHz (up to 100 MHz), independent I and Q channels, or a coherent reference, the VAWS system is a better fit.

For full details on configuring and calibrating VAWS, refer to Application Note AN 343-5 (HP Literature number 5952-6471).

### VAWS Key Contributions

10 - 3000 MHz Frequency Range

100 MHz Arbitrary Waveform Bandwidth

Independent I & Q channels

Deep 512K memory for each channel

Coherent reference

### Popular Applications

BPSK to 256-QAM

Filter simulation

Fully synthesized 100-MHz chirp pulses

Static and dynamic multipath fading

### Ordering Information

HP 8791

Model 11 Frequency Agile Signal Simulator (E2500B)

Model 100 Precision Signal Generator (E2502A)

Model 200 Radar Simulator (E2501A)

### Price

\$220,000

\$6,000

\$11,000

# SIGNAL GENERATORS

## Frequency Agile/Complex Signal Simulation

HP 8780A

- Highest performance and most versatile HP modulation source.
- Now with phase modulation for telemetry signals
- BPSK, QPSK, 8PSK, 16QAM, 64QAM, digital modulation and pulse

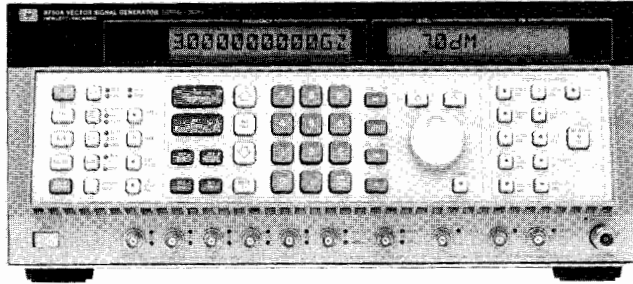

HP 8780A



### HP 8780A Vector Signal Generator

The HP 8780A Vector Signal Generator is a synthesized IF source with exceptional modulation for modern receiver and component testing. It is capable of modulation bandwidths almost 100 times wider than previous synthesizers, and has built-in DACs (digital-to-analog-converters) to simplify generation of common digital modulations. Its extra-wide modulation bandwidth comes from a vector modulator that effectively doubles baseband modulation bandwidths for 700 MHz of output modulation. The vector signal generator's wideband modulation is complemented with an unmodulated coherent carrier output for demodulation of test signals.

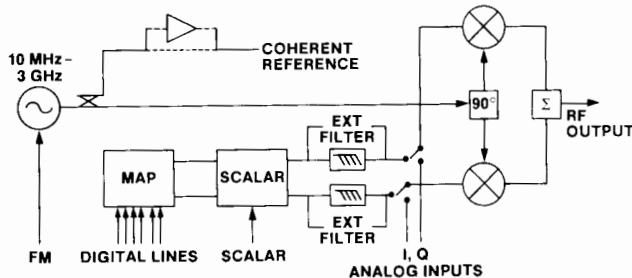

HP 8780A Block Diagram

The Vector Signal Generator offers a wide variety of modulation using both digital and analog inputs. It generates many standard digital modulations like QPSK and 16QAM and traditional modulations like FM, AM and pulse. By combining the different modulation types, signals as diverse as Barker-coded radar pulses and doppler-shifted satellite signals can be simulated.

### Applications

The HP 8780A Vector Signal Generator is well suited for receiver measurements where wideband or complex modulations are required. It can be used as a calibrated transmitter to test modern radar EW receivers or communication receivers using vector I/Q modulation techniques. It provides a stable coherent carrier for phase measurement. It can also be upconverted if receivers operate at frequencies higher than 3GHz.

### Analog Phase Modulation For Telemetry

HP 8780A option H02 offers analog modulation capability, which can be used in tracking and data relay satellite system (TDRSS). The

- Wideband FM: over 200MHz p-p deviations
- 700MHz modulation bandwidth using I/Q or vector
- 10MHz or 3GHz IF testing
- Pulse modulation with 1ns rise times
- Coherent carrier output

ground station needs linear phase modulation to communicate with satellite and establish command and control. The HP 8780A with option H02 can generate the signals used during both on-ground and in-orbit testing.

### HP 8780A Specifications

#### Frequency

**Range:** 10 MHz to 3 GHz.

**Resolution:** 1 Hz.

#### Output

**Level range:** +10 to -100 dBm <2.5 GHz,

+4 to -100 dBm ≥2.5 GHz.

(+12 dBm ≤3 GHz with Opt 064)

#### Coherent Carrier Output

Unmodulated (except for FM) and unlevelled version of front panel RF output available at rear panel.

#### AC Coupled Frequency Modulation

**Rates** (3 dB frequencies): 20 Hz to 12 MHz.

**Deviation ranges:** 50 kHz to 50 MHz peak-to-peak (up to >200 MHz p-p possible with slightly higher distortion by overdriving FM input).

#### DC Coupled Frequency Modulation

**Maximum rate** (3 dB frequency): 10 kHz.

**Deviation ranges:** 150 Hz to 150 kHz peak-to-peak.

#### Digital Modulation

**Modulation types:** BPSK, QPSK, 8PSK, 16QAM (64QAM with Opt. 064), Arbitrary 2-State, Burst (except 64 QAM).

**Parallel data rates:** 0 to 150 MHz clocked (except 64 QAM), 0 to 100 MHz clocked 64QAM w/Opt. 064, 0 to 50 MHz asynchronous.

**Serial data rates** (only with Opt. 064): 0 to 150 MHz clock and data line for 0 to 25 MHz 64QAM symbol rate.

#### Analog phase modulation (only with opt H02)

**Modulation frequency range:** dc to 10MHz

**Modulation level:** 0 to 1.5V peak into 50 ohms

**Modulation sensitivity:** 1 radian/volt

**Modulation index:** variable by changing drive level over the range from 0.2 - 1.5 radians.

#### Scalar Modulation/AM

Traditional AM modulation requires a dc offset of 0.5 V to be added to the scalar input.

**Sensitivity:** 0 to +1 volt for 0 to full scale envelope modulation

#### General

**Operating temperature range:** 0 degrees C to +55 degrees C

**Power:** 100, 120, 220, 240 V, +5%, -10%, 48-440 Hz; 500 VA max

**Weight:** net, 31.5kg (70lb); shipping, 35.5kg (78lb)

**Size:** 177H x 425W x 637mmD (7.0" x 16.7" x 25.1")

#### Ordering Information

HP 8780A Vector Signal Generator	Price
Opt 001: Rear panel output and modulation inputs	\$61,610
Opt 002: +10 dBm Coherent Carrier output	+\$450
Opt 064: 64 QAM modulation	+\$2,500
Opt H02: Analog Phase Modulation	\$2,000
	+\$2,500

# SIGNAL GENERATORS

## Frequency Agile/Complex Signal Simulation

405

HP 8782A

- 1MHz to 250MHz covers 70 and 140MHz IFs
- BPSK QPSK 8PSK 16QAM 256QAM digital modulation and burst

- Internal Pseudo Random Binary Sequence generator
- AM/SCALAR modulation to simulate flat fading
- Coherent carrier output

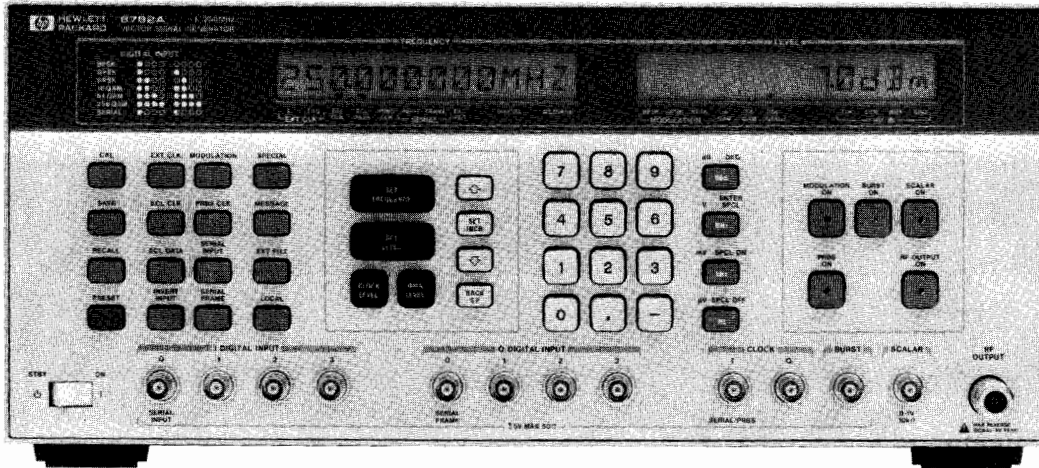

DESIGNED FOR  
**HP-IB**  
SYSTEMS  
HP 8782A

### HP 8782A Vector Signal Generator

The HP 8782A vector signal generator is a second-generation synthesized generator. It supports a wide range of built-in digital modulation from BPSK to 256QAM for microwave terrestrial communications and satellite communications applications. It has a 1 MHz to 250 MHz frequency range, which covers most of the IF frequencies in commercial receivers. An internal pseudo-random bit sequence (PRBS) generator makes all digital modulation possible without using external digital data sources. It also provides an unmodulated coherent carrier output for testing receivers and subsystems before carrier recovery circuits are working. The cost is substantially lower than the HP 8780A Vector Signal Generator, providing IF signal generation for R&D and manufacturing.

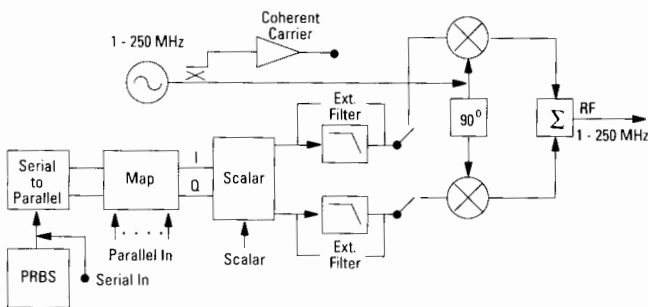

HP 8782A Block Diagram

The HP 8782A offers a wide variety of digital modulation using either the internal PRBS generator or user data source. It generates calibrated test signals as well as specified modulation impairments such as quadrature errors, I/Q imbalance, carrier leakage, and flat fading.

### Applications

Using the HP 8782A to align digital radios in manufacturing can improve radio quality. Instead of relying on a golden standard modulator from R&D, the HP 8782A can provide calibrated constellations with extremely low quadrature error and amplitude imbalance. Customers can also simulate transmitter impairments by using the HP 8782A to test receiver performance margins.

### HP 8782A Specifications

#### Frequency

**Range:** 1MHz to 250MHz

**Resolution:** 1HZ

**RF output level:** +7 to -100 dBm for all formats.

#### Coherent Carrier Output

Typically +10dBm up to 140 MHz

Typically +8.5dBm at >150MHz

#### Digital Modulation

**Modulation types:** BPSK, QPSK, 8PSK, 16 QAM, 64QAM, 256QAM, 9PRS, 25PRS, 49PRS, 81PRS

**Parallel data rates:** 0 to 100MHz clocked, 0 to 50 MHz asynchronous.

**Serial data rates:** 0 to 200MHz clock and data lines for drive signal rise times <1.0 μs.

**Data input threshold:** ECL: -1.3V fixed threshold level.

TTL: -2.5V to +2.5V adjustable.

C/N Degradation from theoretical: for 256QAM @ BER = 10E-6, 40MHz BW, 70MHz IF, 0.5 excess BW Nyquist Filter, the Total HP8782A Degradation is typically ≤ 1.25dB.

#### Burst Modulation

**Burst rates:** 0 to 50MHz

**Burst dc on/off ratio:** >50 dB at 70MHz carrier typical >50 dB from 1 to 250MHz

**Burst rise/fall time:** <2.2ns

**PRBS:** internal Pseudo Random Binary sequence generator with 2<sup>23</sup>-1 sequence length

#### AM/SCALAR Modulation

**Sensitivity:** 0 to +1V for 0 to full scale output power.

**Frequency response:** dc to 50KHz at 70MHz carrier frequency

#### General

**Operating temperature range:** 0C to +55C

**Power:** 100, 120, 220, or 240 Vac, 48 to 66Hz; 100 or 120 Vac 360 to 440 Hz; 360 VA typical.

#### Ordering Information

HP 8782A Vector Signal Generator

#### Price

\$30,300

# SIGNAL GENERATORS

## Portable Cavity-Tuned Source

HP 8640B

- 0.5 to 512 MHz frequency range with optional coverage to 1024 MHz
- +19 to -145 dBm output power range
- Low SSB phase noise
- Calibrated, metered AM, FM and pulse modulation
- Internal phase lock/synchronizer, digital frequency readout, external count capability to 550 MHz

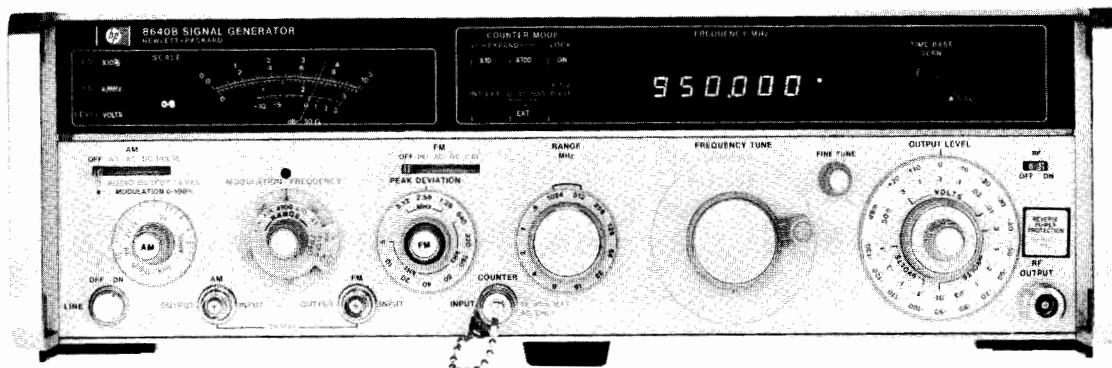

HP 8640B (with Options 001, 002, 003)

### HP 8640B Signal Generator

The HP 8640B Signal Generator covers the frequency range 500 kHz to 512 MHz and can be extended to 1024 MHz with an internal doubler (Option 002). Using the HP 11710B Down Converter, the HP 8640B frequency range can be extended down to 10 kHz. An optional internal audio oscillator (Option 001) has a frequency range of 20 Hz to 600 kHz.

The HP 8640B has an output level range of +19 to -145 dBm (2V to 0.013  $\mu$ V) which is calibrated, metered, and leveled to within  $\pm 0.5$  dB across the full frequency range of the instrument. The output is protected against up to 50W of reverse power (with Option 003).

The HP 8640B also has AM, FM, and pulse modulation for a wide range of receiver test applications.

#### Spectrally Pure Output Signals

Noise of the HP 8640B is extremely low beyond 10 kHz offsets. At a 20 kHz offset from the carrier, SSB phase noise is  $< -130$  dBc at 450 MHz and  $< -122$  dBc at 550 MHz. Broadband noise floor is better than -140 dBc/Hz.

#### Phase Locked Stability

The HP 8640B can phase lock to the RF output frequency of the crystal timebase used in the counter (resulting in drift that is better than  $5 \times 10^{-8}$ /hr) while still maintaining its spectral purity. The HP 8640B can also be locked to an external 5 MHz standard.

In the phase locked mode, FM capability and spectral purity are maintained while providing FM rates from 50 Hz to 250 kHz.

### HP 8640B Specifications

#### Frequency

**Range:** 500 kHz to 512 MHz in 10 octaves, (1024 MHz with Option 002 internal frequency doubler).

#### Fine Tuning

**Unlocked:**  $> 1000$  ppm total range.

**Locked mode:**  $\pm 20$  ppm by varying internal time base vernier.

#### Internal Counter Resolution (unlocked)

Frequency Ranges (MHz)	Normal Mode	Expand X10	Expand X100
0.5-1	10 Hz	1 Hz	0.1 Hz
1-16	100 Hz	10 Hz	1 Hz
16-128	1 kHz	100 Hz	10 Hz
128-1024	10 kHz	1 kHz	100 Hz

#### Optimum Counter Resolution When Phase-Locked

Frequency Ranges (MHz)	With 6 Digits	$\pm 1/2$ Digit
0.5-0.9999995	1 Hz	0.5 Hz
1.0-9.999995	10 Hz	5 Hz
10.0-99.99995	100 Hz	50 Hz
100.0-999.9995	1 kHz	500 Hz
1000-1024	10 kHz	5 kHz

**Accuracy:**  $6\frac{1}{2}$  digit LED display with X10 and X100 expand; accuracy depends on internal or external reference used.

#### Stability (after 2 hr warmup):

Normal:  $< 10$  ppm/10 min. Locked:  $< 0.05$  ppm/hr.

#### Restabilization time after frequency change:

Normal:  $< 15$  min. Locked:  $< 1$  min. to be within 0.1 ppm.

#### Output

**Range:** 10 dB steps and 18 dB vernier provide the following output power settings into 50 $\Omega$ .

Frequency Range (MHz)	HP 8640B	With Option(s)		
		002	003	002/003
0.5-612	+19 to -145 dBm	+18.5 to -145 dBm	+18.5 to -145 dBm	+18 to -145 dBm
512-1024 (Opt 002)		+13 to -145 dBm		+12 to -145 dBm

**Level Flatness** (referred to output at 50 MHz and applies to 1V range and for top 10 dB of vernier range)

Frequency Range (MHz)	HP 8640B	With Option(s)		
		002	003	002/003
0.5-64	$\pm 0.5$ dB	$\pm 0.75$ dB	+0.75 dB -1.25 dB	+1.0 dB -2.0 dB
64-512 512-1024 (Opt 002)		$\pm 1.0$ dB $\pm 1.5$ dB		$\pm 2.0$ dB

**Level accuracy:** (worst case as indicated on level meter)  $\pm 1.5$  dB to  $\pm 4.5$  dB depending on level, frequency, and options installed.

### Spectral Purity

#### Harmonics (at 1V, +10 dBm output range and below):

- <-30 dBc, 0.5 to 512 MHz;
- <-12 dBc, 512 to 1024 MHz (Option 002).

#### Spurious (greater than 15 kHz offsets):

- Nonharmonically related: <-100 dBc;
- Subharmonically related: <-100 dBc, <-20 dBc;  $f_c > 512$  MHz
- Residual AM (averaged rms in a 0.3 - 3 kHz BW): <-85 dBc.
- Residual FM (averaged rms in a 0.3 - 3 kHz BW): <5 Hz, (<10 Hz;  $f_c > 512$  MHz).

Measured SSB phase noise (typical): triangles are specified limits:

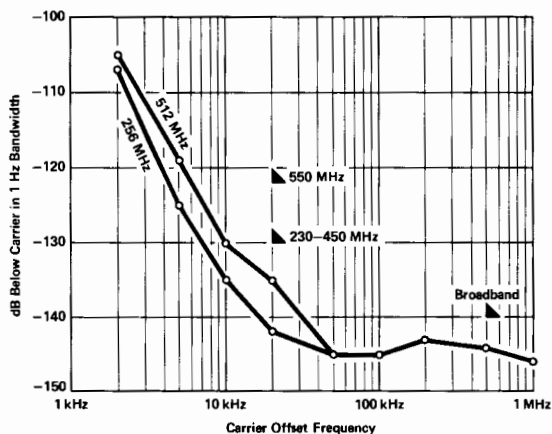

### Modulation

**General:** internal AM, FM, external AM, FM and Pulse.

#### Simultaneous AM and FM or Pulse and FM.

**Frequency:** fixed 400 Hz and 1 kHz  $\pm 3\%$ ; also, 20 Hz to 600 KHz,  $\pm 15\%$  with Opt. 001.

**Output level:** Standard: 10 mV to 1  $V_{rms}$  into 600 $\Omega$ .  
Opt. 001: 1 mV to 3  $V_{rms}$  into 600 $\Omega$ .

#### Amplitude Modulation

**Depth:** 0 to 100%, amplitude <+13 dBm; 0 to 100%, amplitude <+7 dBm (excluding top 6 dB of vernier) at  $f_c > 512$  MHz.

#### AM Bandwidth

**Standard:** 3 dB bandwidth (lower ac limit is 20 Hz)

Frequency Ranges	0 to 50% AM	50 to 90% AM
0.5 to 2 MHz	dc - 20 kHz	dc - 12.5 kHz
2 to 8 MHz	dc - 40 kHz	dc - 25 kHz
8 to 512 MHz	dc - 60 kHz	dc - 50 kHz
512 to 1024 MHz	dc - 60 kHz	dc - 50 kHz

#### AM distortion (400 Hz and 1 kHz rates):

- <1%, 0 - 50% AM; <3%, 50 - 90% AM;
- <10%, 0 - 30% AM ( $f_c > 512$  MHz);
- <20%, 30 - 90% AM ( $f_c > 512$  MHz).

**External input impedance:** 600 $\Omega$ .

#### AM sensitivity (400 Hz and 1 kHz rates into 600 $\Omega$ ):

0.1% AM/mV peak; (0.1 $\pm$ 0.005)% AM/mV pk when  $f_c < 512$  MHz.

#### AM accuracy: (400 and 1 kHz rates)

$\pm$ (5.5% of reading +1.5% of full scale),  $f_c < 512$  MHz.

**Incidental  $\theta$  (at 30% AM):** <0.15 rad,  $f_c < 128$  MHz; <0.3 rad,  $f_c < 512$  MHz; 0.6 rad,  $f_c > 512$  MHz.

### Pulse Modulation<sup>1</sup>

	Frequency Ranges (MHz)					
	0.5-1	1-2	2-8	8-32	32-512	512-1024
Rise and Fall Times	<9 $\mu$ s	<4 $\mu$ s	<2 $\mu$ s	<1 $\mu$ s		<1 $\mu$ s (typical)
Pulse Repetition Rate	50 Hz to 50 kHz		50 Hz to 100 kHz	50 Hz to 250 kHz	50 Hz to 500 kHz	
Minimum Pulse Width <sup>2</sup>	10 $\mu$ s	5 $\mu$ s	2 $\mu$ s			
Pulse ON/OFF ratio at max. vernier	>40 dB					>60 dB
Peak Input Required	Nominally +0.5V (5V max). Sinewave or pulse return to zero into 50 $\Omega$					

#### Frequency Modulation

**Deviation:** 640 kHz,  $f_c$ : 64 to 128 MHz. (Deviation doubles at each octave above 128 MHz and halves at each octave below 64 MHz.)

**FM 3 dB bandwidth:** internal and external ac, 20 Hz to 250 kHz; external dc, dc to 250 kHz. (Locked mode: FM above 50 Hz only).

#### FM distortion (at 500 Hz and 1 kHz rates):

- <1% for deviations up to  $\frac{1}{8}$  maximum allowable.
- <3% up to maximum allowable deviation.

**External FM sensitivity:** 1V peak into 600 $\Omega$  yields maximum deviation indicated on PEAK DEVIATION switch with FM vernier at full clockwise position.

**Indicated FM accuracy (400 Hz and 1 kHz rates from 15 $^\circ$  to 35 $^\circ$ C, using internal meter):** +(7% of reading + 1.5% of full scale).

#### Incidental AM (at 400 Hz and 1 kHz rates)

- 0.5-512 MHz: <0.5% AM for FM up to  $\frac{1}{8}$  maximum allowable deviation; <1% AM for FM at maximum allowable deviation.
- 512-1024 MHz (Opt. 002): <1% AM for FM up to  $\frac{1}{8}$  maximum allowable deviation; <7% AM for FM deviations up to maximum allowable.

### Counter

**Frequency range:** 1 Hz to 550 MHz.

**Sensitivity:** >200 mV $_{rms}$  from a 50 $\Omega$  source impedance, ac only.

**Resolution (6 digit LED display with X10 and X100 expand mode):** 100 Hz for  $f_c$ : 0 - 10 MHz; 10 kHz for  $f_c$ : 10 - 550 MHz.

#### General

**External reference input:** 5 MHz, nominally >0.5  $V_{pp}$  into 1 k $\Omega$ .

**Internal reference (after 2 hr. warmup at 25 $^\circ$ C):**

**Aging rate:** <0.05 ppm/hr; <2 ppm/90 days.

**Drift:** <2 ppm; 15 to 35 $^\circ$ C, <10 ppm; 0 to 50 $^\circ$ C.

**Typical accuracy:**  $\pm 2$  ppm; 15 to 35 $^\circ$ C.

**Operating temperature:** 0 to 55 $^\circ$ C.

**Power requirements:** 100, 120V (+5%, -10%); 48 to 440 Hz, 220, 240V (+5%, -10%); 48 to 66 Hz. 175 VA max (Opt. 002: 190 VA max).

**Weight:** net, 20.8 kg (46 lb); shipping, 24.1 kg (53 lb).

**Size:** 140H x 425W x 467 mmD (5.5" x 16.75" x 18.75").

#### Ordering Information

8640B Signal Generator

Opt 001 20 Hz - 600 kHz internal audio oscillator

Opt 002 Internal doubler 512 - 1024 MHz

Opt 003 Reverse power protection

Opt 908 Rack mount kit (5060-8740)

Opt 910 Provides an additional operation and calibration manual (08640-90208) and two service manuals (08640-90215).

Opt 915 Add service manual (08640-90215)

Opt W30 Extended repair service. See page 723.

Opt W32 Calibration Service. See page 723.

<sup>1</sup>Pulse performance degrades below 500 Hz repetition rates.

<sup>2</sup>For level accuracy within 1 dB of CW (>0.1% duty cycle).

☎ For same-day shipment, call HP Direct at 800-538-8787

#### Price

\$14,600

+\$600

+\$1,255

+\$455

+\$39

+\$350

+\$155

+\$315

+\$3,260

# SIGNAL GENERATORS

## Portable Cavity-Tuned Sources, Pulse Modulator

HP 8683/8684B,D, 11720A

- Portable signal generators with high performance modulation
- Internal pulse modulation source
- Wide FM deviation for satellite video  $\pm 10$  MHz peak
- dc coupled FM with rates to 10 MHz

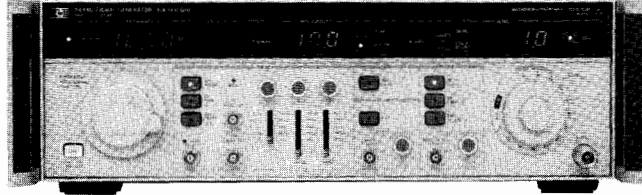

HP 8684D

### HP 8683/8684 Microwave Signal Generators

The HP 8683 and 8684 are rugged portable signal generators designed for demanding benchtop and field maintenance environments.

With high performance AM, FM and pulse modulation, including a built in pulse generator, the HP 8683/84 provides the capability to test modern communications, radar and EW systems.

#### Frequency

##### Range

**HP 8683B:** 2.3–6.5 GHz.

**HP 8683D:** 2.3–13.0 GHz.

**HP 8684B:** 5.4–12.5 GHz.

**HP 8684D:** 5.4–18.0 GHz.

**Resolution:** HP 8683, 5 MHz using a 4 digit LED display; HP 8684, 10 MHz using a 3 1/2 digit LED display.

#### Stability (typical)

**vs. time (20 min. after turn-on):** <30 kHz/min.

**vs. time (60 min. after turn-on):** <100 kHz/hr.

**vs. temperature (0°C to 55°C):** HP 8683, <15 MHz;

HP 8684, <30 MHz.

**vs. line voltage (transients of +5%/-10%):** <20 ppm.

#### Spectral Purity

**Harmonics (<18GHz, at specified max output):** <-25 dBc.

HP 8683/84D harmonics are unspecified in x2 frequency band.

**Spurious (non-harmonically related):** <-80 dBc; typ, <-90 dBc.

**Single-sideband phase noise (avg. rms, 1 Hz BW, 10 kHz offset from carrier, typical):** HP 8683B, <-72 dBc; HP 8683D, <-66 dBc; HP 8684B, <-65 dBc; HP 8684D, <-59 dBc.

#### Output

**Range (leveled into 50Ω):** HP 8683/84B, +10 to -130 dBm;

HP 8683/84D, +10 to -130 dBm (main band), -3 to -130 dBm (x2 band), +10 dBm in x2 bands available with Option 001.

**Resolution:** 0.1 dB using a 3 1/2 digit LED display.

**Accuracy:**  $\pm 2.5$  dB from maximum specified output power to -110 dBm (to -100 dBm in x2 bands);  $\pm 3.5$  dB to -120 dBm and 0 to +10 dBm for Opt 001. *Typ.  $\pm 0.9$  dB at -100 dBm.* Option 002 affects level accuracy  $\pm 0.5$  dB.

**Flatness (power level >-10 dBm):**  $\pm 1.0$  dB. (Not for Opt. 001)

#### Amplitude Modulation

**Depth (1 kHz rate):** 0-70%.

**Rates (3 dB BW at 40% depth):** dc to 10 kHz (dc coupled); 50 Hz to 10 kHz (ac coupled).

**Internal AM:** fixed 1 kHz nom. square wave with 50  $\pm 5\%$  duty cycle.

#### Frequency Modulation

**Peak deviation:** HP 8683/84 B,  $\pm 5$  MHz; HP 8683/84D,  $\pm 5$  MHz (main);  $\pm 10$  MHz (x2 band).

**Rates (3 dB BW):** dc to 10 MHz, 100 Hz to 10 MHz (ac coupled).

**Internal FM:** FM sawtooth with a fixed sweep rate of 1 kHz nom. and variable deviation up to  $\pm 5$  MHz ( $\pm 10$  MHz for D models, x2 bands).

#### Pulse Modulation

##### HP 8683/84 B/D internal pulse generator

**Rate:** 10 Hz to 1 MHz continuously adjustable in 5 ranges.

**Width:** 50 ns to 100 ms continuously adjustable in 7 ranges.

**Delay (time between sync out and video out):** <50 ns to 100 ms in 7 ranges with continuous adjustment within ranges.

##### 2 to 18 GHz Pulse Modulator

- <10 ns rise and fall times
- >80 dB ON/OFF ratio

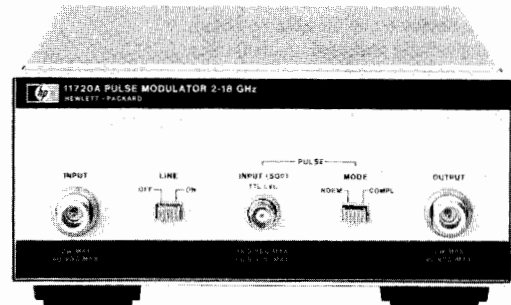

HP 11720A

##### HP 8683/84 B/D external pulse input requirements

**Rate:** 0 to 1 MHz.

**Width:** >100 ns.

**Level:** on >+1.0 V peak; off <+0.4 V peak.

##### HP 8683/84 B/D RF pulse specifications

**Rise/fall time:** <10 ns.

**On/off ratio:** >80 dB.

**Minimum pulse width:** <100 ns.

**Maximum pulse repetition frequency:** >1 MHz.

**Peak pulse power:**  $\pm 0.5$  dB of level set in CW mode.

#### General

**Operating temperature range:** 0°C to 55°C.

**EMI:** MIL-STD-461, VDE0871, CISPR Pub. 11.

**Power:** 100, 120, 220 or 240V, +5%, -10%; 48 to 66 Hz; <200 VA max.

**Size:** 145 H x 457 W x 472 mm D (5.7" x 18" x 18.6").

**Weight:** HP 8683: net, 17.9kg (39 lb); shipping, 23.4 kg (51 lb).

HP 8684: net, 16.5 kg (36 lb); shipping, 22.0 kg (48 lb).

### HP 11720A Pulse Modulator

The HP 11720A Pulse Modulator is a high-performance microwave pulse modulator covering the range of 2 to 18 GHz.

In addition to wide frequency coverage, the HP 11720A features extremely short rise and fall times (<10 ns) and a high on/off ratio (>80 dB), making it suitable for almost any pulsed RF application.

**Frequency range:** 2 to 18 GHz.

**ON/OFF ratio:** >80 dB.

**Rise and fall times:** <10 ns.

**Insertion loss:** <6 dB, 2 to 12.4 GHz; <10 dB, 2 to 18 GHz.

**Maximum RF input power:** +20 dBm.

**Maximum repetition rate:** >5 MHz.

**Minimum RF pulse width:** <50 ns.

**Video feedthrough:** <60 mV peak-to-peak.

**Operating temperature:** 0°C to 55°C

**Power:** 100, 120, 220, 240 V, +5%, -10%; 48-400 Hz; 25VA max

**Weight:** net, 2.6 kg (5 lb 12 oz); shipping, 3.6 kg (8 lb.).

**Size:** 101 H x 212 W x 290 mm D (4.0" x 8.4" x 11.4")

#### Ordering Information

**HP 8683/84B Microwave Signal Generator** \$21,000

**Opt W30:** Extended repair service. See page 723. +\$410

**HP 8683/84D Microwave Signal Generator** \$25,000

**Opt 001** +10 dBm in x2 band, HP 8683D +\$3,000

**Opt 001** +10 dBm in x2 band, HP 8684D +\$5,000

**Opt W30** Extended repair service. See page 723. +\$530

**Opt 002** Reverse power protection (except D models) +\$725

**Opt 910** Extra operating and service manual +\$50

**Opt 913** Rack mounting flange kit +\$35

**HP 11720A Pulse Modulator** \$4,200

**Opt W30** Extended repair service. See page 723 +\$95



# SIGNAL GENERATORS

Accessories, Frequency Doublers

HP 11509A, 11687A, 11690A, 11710B, 11721A

409

- Additional capabilities for signal generators



HP 11687A



HP 11509A

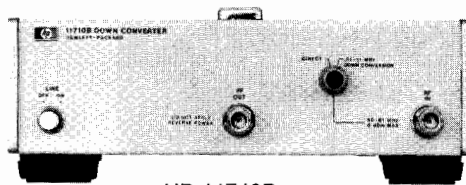

HP 11710B



HP 11690A



HP 11721A

## HP 11509A Fuseholder

Accidental burnout of attenuators in HP 8640 and HP 8654 signal generators can be prevented by using this fuse element between the signal generator and a transceiver. The fuseholder has a frequency range of dc to 480 MHz, insertion loss of  $\leq 1$  dB, SWR of  $\leq 1.35$  (50 $\Omega$  load), and Type N connectors. Ten extra fuses are furnished.

## HP 11687A 50-75 $\Omega$ Adapter

This 50-75 $\Omega$  adapter with Type N connectors is recommended for use with HP 8640, 8642, 8654, 8660, 8656, and 8662 signal generators for measurements in 75 $\Omega$  systems. The voltage calibration on the output level meter is unaffected by use of the adapter, but 1.76 dB must be subtracted from the dB scale on the meter to determine the output in dBm into 75 $\Omega$ . Frequency range is dc to 1300 MHz.

## HP 11690A Frequency Doubler

The HP 11690A extends the frequency range of all HP 8640 series signal generators by doubling the 256-512 MHz frequency band up to 1024 MHz (to 110 MHz with band overrange). All HP 8640s indicate the correct doubled output frequency on a dial or counter when the 512-1024 MHz range is selected. The HP 11690A will also perform well with any source meeting the input requirements of 200-550 MHz at +10 to +19 dBm. Conversion loss is  $< 13$  dB, output flatness has  $< 4$  dB total variation, and the first and third input harmonics are suppressed  $> 20$  dB. Connectors are BNC.

## HP 11710B Down Converter

The HP 11710B Down Converter is an accessory for the HP 8640 and HP 8654 series signal generators. Frequency inputs from 50.01 to 61 MHz are down converted to the 10 kHz to 11 MHz range respectively. The output level and modulation functions of the HP 8640 and HP 8654 remain calibrated. A straight-through selection switch allows the input to pass through unchanged, and thus minimizes the necessity to move cables when testing. Option 001 provides rails and semi-rigid coax for combining the HP 11710B with an HP 8654A/B Signal Generator.

## HP 11710B Specifications

### Input

**Down-conversion mode:** 50.01 to 61.00 MHz at  $\leq 0$  dBm.

**Straight-through mode:** 0.01 to 1100 MHz (dc coupled).

### Down-Converted Output

**Frequency range:** 10 kHz to 11 MHz.

**Level range:** 0 to  $-107$  dBm

**Level flatness:** RF source flatness  $\pm 0.5$  dB (referred to 4.0 MHz).

**Total level accuracy:**  $\pm (1$  dB plus input level accuracy).

**Harmonics:**  $> 35$  dB below the carrier (dBc).

**Intermixing spurious:**  $> 60$  dBc.

**Local oscillator feed-through (50 MHz):**  $< -100$  dBm.

## Internal Reference Characteristics

**Time base output:** 1 MHz or 5 MHz selectable, nominally  $> 0.5$  V p-p into 500 $\Omega$ . This will drive an HP 8640B external time base input.

**Typical overall accuracy:** (within 3 months of calibration and from 15°C to 35°C):  $\pm 2$  ppm.

## General

**Operating temperature range:** 0° to 55°C.

**Power requirements:** 100, 120, 220, 240V (+5%, -10%), 48 to 440 Hz; 25 VA maximum.

**Weight:** net, 3.2 kg (7 lb); shipping, 4.5 kg (9 lb).

**Size:** 102 H  $\times$  266 W  $\times$  295 mm D (4"  $\times$  10.5"  $\times$  11.6").  $\frac{1}{2}$  MW  $\times$  4 H  $\times$  11 D System 1 Module.

## HP 11721A Frequency Doubler

The HP 11721A Doubler is an ideal accessory for extending the usable frequency range of signal generators, frequency synthesizers, or other signal sources. Operating on input frequencies of 50 MHz to 1300 MHz, it provides a doubled output in the range of 100 MHz to 2600 MHz. The HP 11721A will work well with any RF source with an output in the range 50 to 1300 MHz.

The 50 $\Omega$  passive circuit of the HP 11721A offers low conversion loss, low spurious, and excellent flatness over its entire frequency range when operated above +10 dBm.

## HP 11721A Specifications

**Input frequency range:** 50 to 1300 MHz.

**Output frequency range:** 100 to 2600 MHz.

**Conversion loss (+13 dBm input, 50 to 1280 MHz):**  $< 15$  dB.

**Spurious referenced to desired output frequency f (+13 dBm input with harmonics  $< -50$  dBc, 50 to 1280 MHz):**  $f/2$ ,  $-15$  dB;  $3f/2$ ,  $-15$  dB.

**Input SWR:** 1.5 typical.

**Input/output impedance:** 50 $\Omega$  nominal.

**Operating temperature range:** 0° to +50°C.

**Connectors:** input, type N male; output, type N female.

**Size:** 161 L  $\times$  30 W  $\times$  20.5 mm H (6  $\frac{3}{8}$ "  $\times$  1  $\frac{3}{16}$ "  $\times$  1  $\frac{1}{16}$ ").

**Weight:** net, .02 kg (0.5 lb); shipping, 0.4 kg (1 lb).

## Ordering Information

	<b>Price</b>
HP 11509A Fuseholder	\$300
HP 11687A 50 $\Omega$ -75 $\Omega$ Adapter	\$235
HP 11690A Frequency Doubler	\$325
Opt W32 Calibration service. See page 723	+ \$720
HP 11710B Down Converter	\$3,380
Opt 001 Combining Kit	\$165
Opt 910 2 sets of operation/service manuals (11710-90005)	\$6
Opt W30 Extended repair service. See page 723	+ \$70
Opt W32 Calibration service. See page 723	+ \$155
HP 11721A Frequency Doubler	\$735
Opt W30 Extended repair service. See page 723	+ \$50

☎ For same-day shipment, call HP DIRECT at 800-538-8787

# SWEEP OSCILLATORS

## General Information

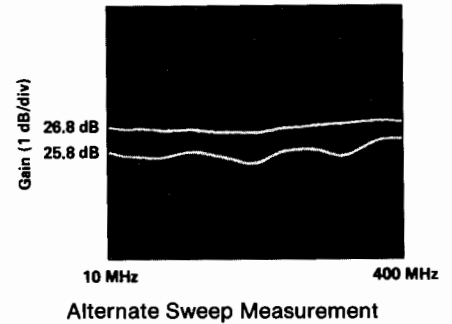
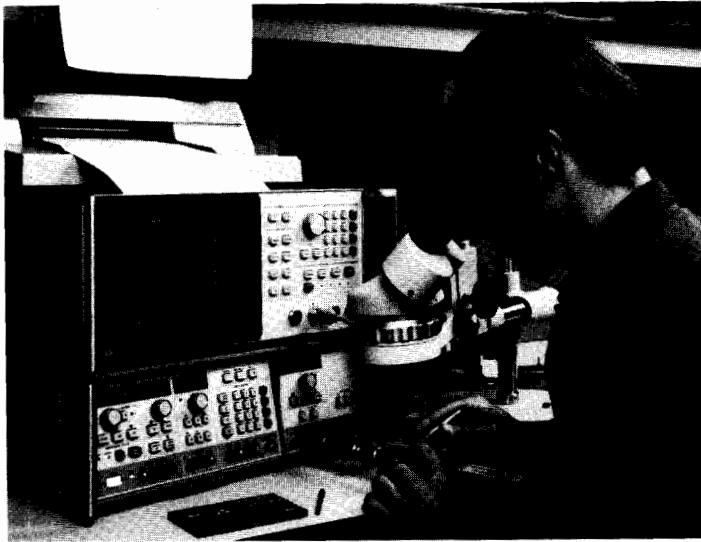

### Sweep Oscillators

Sweep oscillators are important in a number of applications where the characteristics of a device or system must be determined over a continuous range of frequencies. By replacing laborious point-by-point techniques, swept measurements increase the speed and convenience of broadband testing. The continuous frequency characterization of the unknown device or system also eliminates the chance of missing important information between frequency points.

Hewlett-Packard sweepers cover the entire frequency spectrum from dc to 110 GHz. The HP 8350 family of solid state oscillators provide a versatile choice of configurations—single band, straddle band, or very wide band plug-ins. The HP 8360 series, the HP 8340B and the HP 8341B are broadband synthesizers that combine the excellent stability, frequency accuracy, and phase noise of a synthesizer with the versatile characteristics of a sweep oscillator. And for coverage in the millimeter-wave frequency range, the HP 83550-series frequency multipliers effectively extend the excellent performance of Hewlett-Packard's sweep oscillator family to 110 GHz.

A chart of the complete frequency coverage of Hewlett-Packard's line of sweep oscillators is shown on page 411.

#### Sweep flexibility

Every HP sweeper has several different sweep modes available for setting the frequency limits of the instrument. A full band or independently adjustable start/stop frequency sweep can be selected. Alternately, a marker sweep or a symmetrical  $\Delta F$  sweep about the desired center frequency can be chosen. Sweep times from 0.01 to more than 100 seconds are possible.

Marker capability, both Z-axis intensity dots and RF pips, are available on HP sweepers to note important measurement frequencies. Up to five independent markers are offered on all sweepers, the HP 8360 series, HP 8340B/41B and HP 8350 mainframe. Crystal markers are also offered on the HP 86222B, 83522A, and 83525A/B RF plug-ins.

Another powerful feature available on the HP 8360 series, HP 8340B/8341B and 8350 sweeper mainframe is the Save/Recall Mode, where up to nine (eight on the 8360 series), complete front panel states can be stored in memory and later recalled when the measurement is repeated.

The HP 8360 series, 8340/8341, 8350 sweep oscillator mainframe and 83500 series RF plug-ins offer total HP-IB control of all front panel functions.

#### Power output and leveling

Power output is continuously adjustable at the front panel with built-in attenuators available on most plug-ins for greater power control. Internal or external leveling capability ensures high accuracy when making swept measurements.

For applications that require high power, the HP 83623A (.01-20GHz) synthesized sweeper offers +17 dBm leveled output power, while the HP 83624A (2-20 GHz) synthesized sweeper provides +20 dBm. Also the HP 83550A with the HP 8350 sweep oscillator mainframe offers at least +20 dBm of leveled output power from 2 to 18.6 GHz and +18 dBm to 20 GHz.

When higher output power is required from an existing source, the HP 8349B microwave amplifier (2 to 20 GHz) can be driven by the RF output of the sweeper to provide a full +20 dBm of output power from 2 to 18.6 GHz. The amplifier can be easily leveled via its built-in directional detector and the automatic level control (ALC) circuitry of the sweeper.

Power as well as frequency can be swept with the HP 8360 series, the HP 8340B/8341B or the HP 8350 and 83500 series plug-ins using the Power Sweep function. This means that both the frequency response and power response of level sensitive devices like transistors and amplifiers can be measured using the same test set-up. Using the power sweep function the 1 dB gain compression can easily be measured at a CW frequency. Also, the ability to alternate between two successive sweeps allows a swept measurement of the 1 dB gain compression point.

### Modulation

Modulation capabilities further extend the sweeper's usefulness both as a sweeper and a signal generator for signal simulations. The sweep oscillators described here offer versatile pulse, FM and AM modulation capabilities.

The HP 8360 series synthesized sweeper, as well as all HP 83500 and most 86200 series plug-ins (when used with the HP 8350 sweep oscillator mainframe) are capable of directly producing the 27.8 kHz square wave modulation required by the HP 8757 family of scalar network analyzers, eliminating the need for an external modulator. The HP 8340B/8341B may be externally modulated with the 27.8 kHz square wave, via the scalar analyzer's modulator drive.

#### Low harmonics

For those measurements requiring low harmonics from a swept source there are a number of choices available. The HP 83592C RF plug-in for the HP 8350 sweep oscillator mainframe offers -55 dBc harmonic suppression from 2.4 to 20 GHz. The HP 83595C and HP 83596A/83597A RF plug-ins provide -50 dBc harmonic suppression from 1.5 to 20 GHz. The HP 83596A/83597A also provide -40 dBc from 20 to 40 GHz. The HP 8341B Option 003 specifies -50 dBc harmonics from 1.4 to 20 GHz. The HP 83620A and HP 83640A synthesized sweepers, provide -50 dBc up to 20 GHz. The HP 83640A also specifies -40 dBc from 20 to 40 GHz.

#### Covering millimeter-wave frequencies

The new HP 83550-series millimeter-wave source modules answer the growing need for high-performance sweep oscillators in the millimeter-wave frequency ranges. The source modules are frequency multipliers that effectively extend the excellent performance of HP sweep oscillators covering the 11 to 20 GHz range to the 26.5 to 40 GHz (HP 83554A), the 33 to 50 GHz (HP 83555A), the 40 to 60 GHz (HP 83556A), the 50 to 75 GHz (HP 83557A), and the 75 to 110 GHz (HP 83558A) millimeter-wave frequency ranges.

**Sweeper Applications**

Sweepers are an integral part of many kinds of test applications. Their versatility and extensive feature set make them the perfect choice for scalar/vector network analysis, noise figure measurements, frequency translation measurements, signal simulation and many other applications. The sweepers described here are designed to be compatible with all relevant measurement solutions from HP.

Sweepers are used extensively with swept scalar network analyzers to characterize the amplitude responses of broadband devices or with vector network analyzers when the amplitude and phase characteristics of the device (i.e. s-parameters) are needed. Examples of such analyzers are the HP 8757C/E scalar network analyzers and the HP 8510 vector network analyzer. The HP 8360 series, HP 8340B/8341B and HP 8350B sweepers can be controlled by these analyzers via a private "system interface bus." This makes use of the sweepers full programmability and creates synergistic performance.

For scalar measurements requiring more dynamic range, the HP 8349B microwave amplifier can be used to extend the dynamic range from 76 dB to typically > 90 dB.

For measurements that require an entirely spurious-free environment and phase information, sweepers may be used with vector network analyzers such as the HP 8510. Extremely high performance vector measure-

ments can be made with the HP 8360 series or the HP 8340B/8341B and the HP 8510.

Noise figure measurements above 1600 MHz can be made using the HP 8970 noise figure meter with either the HP 8360 series, the HP 8340B/8341B or the HP 8350 serving as the local oscillator. With this equipment noise figure and gain measurements can be made on microwave components

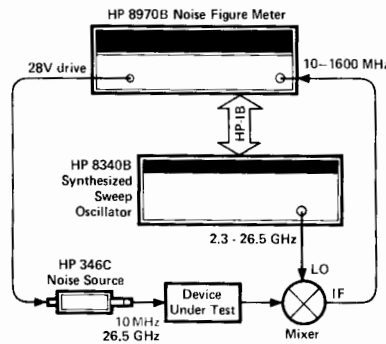

such as amplifiers, transistors or mixers. The HP 8360 series and HP 8340B/41B can also be used as a microwave LO in HP 8902S and 8952S measurement systems that makes several important measurements on microwave sources.

Two-tone sweep testing of devices such as mixers and receiver front ends require two signals offset from each other by the IF. This

is accomplished by phase-locking the difference frequency of two sweep oscillators to a very stable source. The sweepers may then be swept across the band of interest.

In communications applications where up-converter simulation is required in conjunction with the HP Microwave Link Analyzer, several of the HP 86200 series plug-ins are compatible (as an option) with such a system to permit very accurate RF to RF, RF to IF and RF to BB distortion measurements.

The modulation and built-in attenuator features of Hewlett-Packard sweep oscillators make them useful in many traditional CW signal generator applications. The excellent stability, phase noise, frequency range and modulation capability of the HP 8360 series, and the HP 8340B and 8341B make them well suited for most of these applications. In addition, the accuracy, linearity, and flatness of the HP 83500/86200 series broadband plug-ins make them more than adequate in many applications requiring a general purpose CW generator. For wide-band applications these RF plug-ins feature performance that rivals octave band oscillators in the areas of frequency purity and accuracy, harmonics, flatness, and power.

A Product Line Summary of Swept Microwave Sources (HP Part No. 5952-0351), as well as specific data sheets, application notes and product notes are available from your local Hewlett-Packard sales office.

**Sweep Oscillator—Summary Chart**

Frequency Range*	Model Number			Frequency													
	8350 Series	8620 Series**	Other Sweepers	10 MHz	100 MHz	1 GHz	2 GHz	4 GHz	8 GHz	12 GHz	18 GHz	26.5 GHz	40 GHz	50 GHz	60 GHz	75 GHz	110 GHz
10 MHz-2.4 GHz 10 MHz-8.4 GHz 10 MHz-20 GHz 10 MHz-26.5 GHz 10 MHz-40 GHz	HP 83522A HP 83525A/B HP 83592A/B/C HP 83595A/C HP 83597A	HP 86222A/B	HP 83620A/23A 8341B HP 8340B HP 83640A	←	←	←	←	←	←	←	←	←	←	←	←	←	←
1.7-4.3 GHz 2-8.4 GHz 3.6-8.6 GHz 2-18.6 GHz 2-20 GHz 2-22 GHz 2-26.5 GHz 2.4-40 GHz	HP 83540A/B  HP 83590A HP 83594A HP 83596A	HP 86235A HP 86240A/B HP 86240C HP 86290B/C  HP 86290B Opt H08	HP 83622A/24A   HP 83642A		←	←	←	←	←	←	←	←	←	←	←	←	←
3.2-6.5 GHz		HP 86241A					←										
5.9-9.0 GHz 5.9-12.4 GHz 7-11 GHz 7.5-18.6 GHz 8-12.4 GHz 8-20 GHz	HP 83545A  HP 83550A	HP 86242D HP 86245A HP 86250D Opt H08 HP 86251A HP 86250D					←	←	←	←	←	←	←	←	←	←	←
10-15.5 GHz 12.4-18 GHz 17-22 GHz 18-26.5 GHz 26.5-40 GHz	HP 83570A HP 83572C	HP 86260B HP 86260A HP 86260C						←	←	←	←	←	←	←	←	←	←
26.5-40 GHz*** 33-50 GHz*** 40-60 GHz***			HP 83554A HP 83555A HP 83556A									←	←	←	←	←	←
50-75 GHz*** 75-110 GHz***			HP 83557A HP 83558A													←	←

\*Other Special Frequency Ranges Can Be Provided Upon Request.  
 \*\*HP 86200 Series RF Plug-ins are usable with the HP 8350B Mainframe via the HP 11869A Adapter.  
 \*\*\*The HP 83550-series millimeter-wave source modules are frequency multipliers that require a +17 dBm microwave input. See page 410.

# SWEEP OSCILLATORS

## Synthesized Sweepers 10 MHz - 50 GHz (or 110 GHz)

### HP 8360 Series

- 1 Hz frequency resolution (option 008)
- Low spurious and phase noise
- +20 dBm to -110 dBm calibrated output
- Pulse, amplitude, and frequency modulation
- Complete analog sweeper
- <-50 dBc harmonics 1.8 to 20 GHz

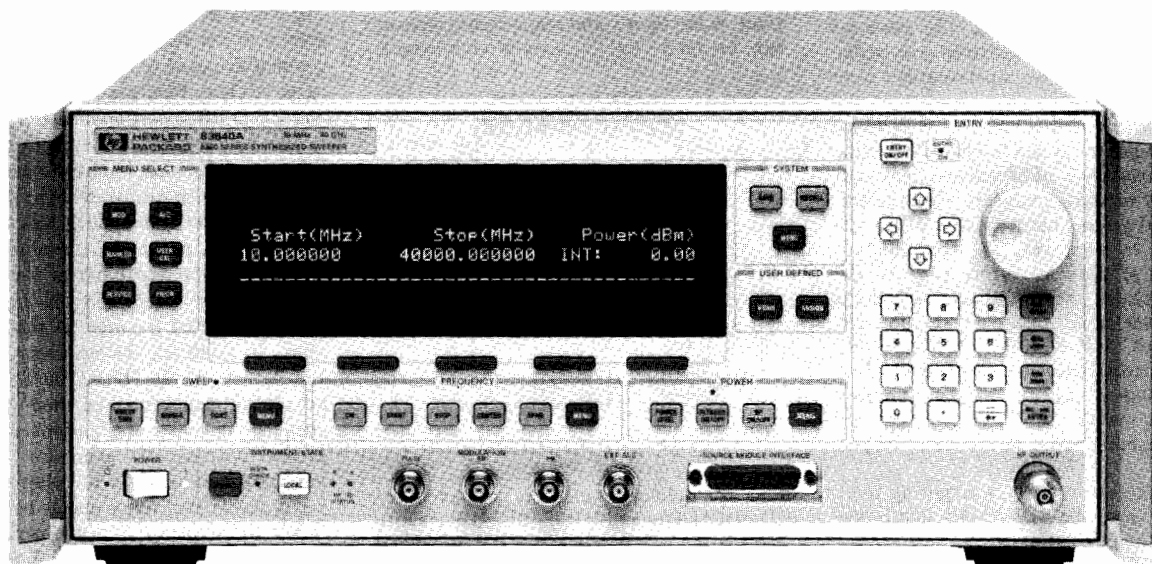

HP 83640A



### HP 8360 Series Synthesized Sweepers

The HP 8360 series synthesized sweepers are the standard of excellence for applications requiring the high performance and accuracy of a synthesized source, and the speed and versatility of a sweep oscillator. The HP 8360 series synthesized sweepers offer the same commitment to quality and reliability that is inherent in the previous industry standard HP 8340/8341.

### Frequency Precision and Spectral Purity

The synthesized broadband frequency coverage and precise 1 Hz frequency resolution (Option 008) are generated by indirect synthesis, enabling the HP 8360 to achieve the same low single-sideband phase noise performance as the HP 8340/8341, HP 8671B, HP 8672A, and HP 8673 series synthesized signal generators.

The HP 8360 provides list and stepped frequency switching times as fast as 5 ms. In addition, the HP 8360 provides arbitrary CW switching times less than 50 ms.

HP 8360A 6.99 GHz PHASE NOISE

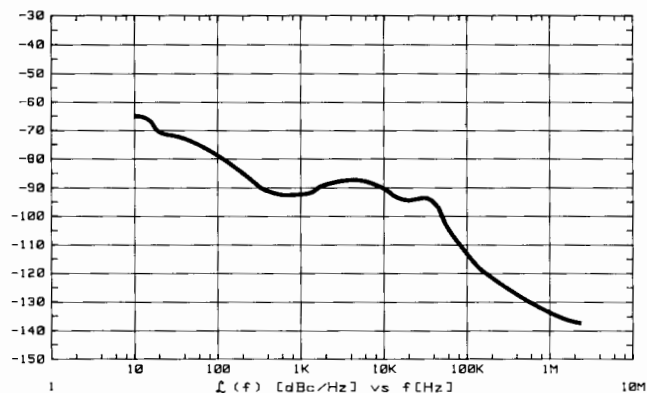

HP 8360 Phase Noise performance from 2.3 to 8.0 GHz

### Output Power

The HP 8360 provides output power ranging between +20 and -110 dBm (Option 001) with 0.02 dB resolution and feature power sweep capability with >20 dB dynamic range for complete characterization of level-sensitive devices.

### <-50 dBc Harmonics

The HP 8360 delivers excellent harmonic performance with harmonics at least 50 dB below the carrier from 1.8 to 20 GHz, and at least 40 dB below the carrier above 20 GHz.

### Pulse, Scan, Amplitude and Frequency Modulation

High-performance pulse modulators with >80 dB on/off ratio, and rise/fall times <10 ns (option 006), make the HP 8360 suitable for the most demanding pulse modulation applications.

In addition to its linear AM mode (100%/V), the HP 8360 offers a new scan modulation mode (10 dB/V). Both of these modes provide dc-coupled amplitude modulation capability with a 3 dB bandwidth of 250 kHz, and 99.7% (50 dB), of modulation depth. Pulse and amplitude modulation capabilities can be used independently and simultaneously.

The HP 8360 also offers dc-coupled frequency modulation capability with rates up to 8 MHz.

### System Compatibility

The versatility of the HP 8360 is evident in its many system applications. The HP 8360 a high performance microwave signal generator with excellent signal purity and modulation capability, and it also serves as a source for stimulus response device characterization, such as network analysis and noise figure measurements.

**Network Analysis**

The HP 8360 series includes two dedicated HP 8510 models that are preconfigured as the recommended system sources for the HP 8510 vector network analyzer (Rev. 4.0+). They have no front panel, rear panel output, 1 Hz resolution. The ability of these sources to produce both narrow and broadband, analog, list, and step sweeps makes them the optimum sources for fast and comprehensive device characterization.

The HP 8360 is also compatible with the HP 8757C/E scalar network analyzers, and produces an internal 27.8 kHz square wave signal for use with the HP 8757 AC detection mode.

In addition, five flexible markers, along with useful marker functions such as marker sweep, marker to center frequency and marker delta simplify swept device testing.

**HP 8970 Noise Figure Systems**

High output power and low broadband noise make the HP 8360 the optimum source for HP 8970 noise figure systems.

**mm-Wave Source Systems**

When driven by an HP 8360 the HP 8355X series millimeter-wave source modules provide millimeter-wave test signals from 26.5 -110 GHz.

**HP 85301 Antenna Systems**

The broadband frequency coverage and 5 ms/point switching speed of the HP 8360 make it the ideal source for the HP 85301A Antenna Measurement System.

**Specifications**

See technical data sheet for complete specifications.

**Frequency**

**Range (By Model):**

- HP 83620A 10 MHz to 20 GHz
- HP 83622A 2 to 20 GHz
- HP 83623A 10 MHz to 20 GHz (High Power)
- HP 83624A 2 to 20 GHz (High Power)
- HP 83640A 10 MHz to 40 GHz
- HP 83642A 2 to 40 GHz

**Resolution (CW Mode):** 1 kHz standard, 1 Hz optional

**Time Base:** Internal 10 MHz time base. Aging rate: less than 5 X 10<sup>-10</sup>/day and 1 X 10<sup>-7</sup>/year after 30 day warm-up.

**RF Output**

**Range:** +20 to -110 dBm

**Resolution:** 0.02 dB

**Maximum Leveled Power (by model):**

- HP 83620A 10 MHz to 20 GHz +10 dBm
- HP 83622A 2 to 20 GHz +10 dBm
- HP 83623A 10 MHz to 20 GHz +17 dBm
- HP 83624A 2 to 20 GHz +20 dBm
- HP 83640A 10 MHz to 40 GHz +2 dBm
- HP 83642A 2 to 40 GHz +2 dBm

**RF Output Connector:**

3.5 mm on 20 GHz Models, 2.4 mm on 40 GHz Models; nominal 50 ohm output impedance.

**Spectral purity**

**Harmonics and subharmonics:**

- <-50 dBc at output frequencies <20 GHz
- <-40 dBc at output frequencies >20 GHz

**Non-harmonically related spurious:**

- <-60 dBc at output frequencies <20 GHz
- <-54 dBc at output frequencies >20 GHz

**Single-sideband phase noise (dBc/1 Hz BW, CW Mode):**

Frequency Range (GHz)	Offset from Carrier			
	100 Hz	1 kHz	10 kHz	100 kHz
.01 - 2.3	-70	-78	-86	-107
2.3 - 7.0	-70	-78	-86	-107
7.0 - 12.5	-64	-72	-80	-101
12.5 - 20.0	-60	-68	-76	-97
20.0 - 25.5	-58	-66	-74	-95
25.5 - 40.0	-54	-62	-70	-91

**Modulation**

**Pulse modulation**

- On/off ratio** >80 dB
- Rise and fall times** <50 ns (<10 ns optional)
- Minimum internally leveled RF pulse width** <1 us
- Minimum unlevelled RF pulse width** <100 ns

**Scan modulation**

- Rates** (3 dB BW) dc to 250 kHz
- Depth** 0 to 50 dB
- Sensitivity** 10 dB/V

**Amplitude modulation**

- Rates** (3 dB BW) dc to 250 kHz
- Depth** 0 to 90% (20 dB), and 0 to 99.7% (50 dB) above 10 Hz
- Sensitivity** 100%/V and 10 dB/V

**Frequency modulation**

- Locked mode**
- Modulation rate** (3 dB BW) 100 kHz to 8 MHz
- Peak deviations** 8 MHz
- Unlocked mode**
- Modulation rate** (3 dB BW) dc to 8 MHz
- Peak deviations** 8 MHz
- Sensitivity** 1 MHz/V or 10 MHz/V, user selectable

**Ordering Information**

**Price**

<b>HP 8360 models</b>	
HP 83620A Synthesized Sweeper	\$35,900
HP 83622A Synthesized Sweeper	\$32,900
HP 83623A Synthesized Sweeper	\$42,900
HP 83624A Synthesized Sweeper	\$39,900
HP 83640A Synthesized Sweeper	\$49,900
HP 83642A Synthesized Sweeper	\$46,900
Opt 001 Add Step Attenuator	\$2,000/\$3,800
Opt 002 Internal Modulation Source	\$2,000
Opt 003 Delete Front Panel Keyboard/Display	-\$1,500
Opt 004 Rear Panel RF Output	\$200
Opt 006 Fast Pulse Modulation	\$4,000
Opt 008 1 Hz Frequency Resolution	\$2,500
Opt 700 Mate System Compatibility	\$4,000
Opt W30 Extended Repair Service. See page 723.	
Opt W32 Calibration Service. See page 723.	
<b>Dedicated HP 8510 Synthesized Sweepers</b>	
HP 83621A Synthesized Source	\$33,900
HP 83631A Synthesized Source	\$42,900
HP 83651A Synthesized Source	\$49,900
Opt W30 Extended Repair Service. See page 723.	
Opt W32 Calibration Service. See page 723.	

# SWEEP OSCILLATORS

## Model 8350 Series: 10 MHz to 40 GHz

### HP 8350 Series

- Versatile microprocessor-controlled mainframe
- Single-band, straddle-band and broad band plug-ins
- 10 MHz to 40 GHz from a single plug-in
- 10 mW output power to 26.5 GHz
- Total HP-IB programmability

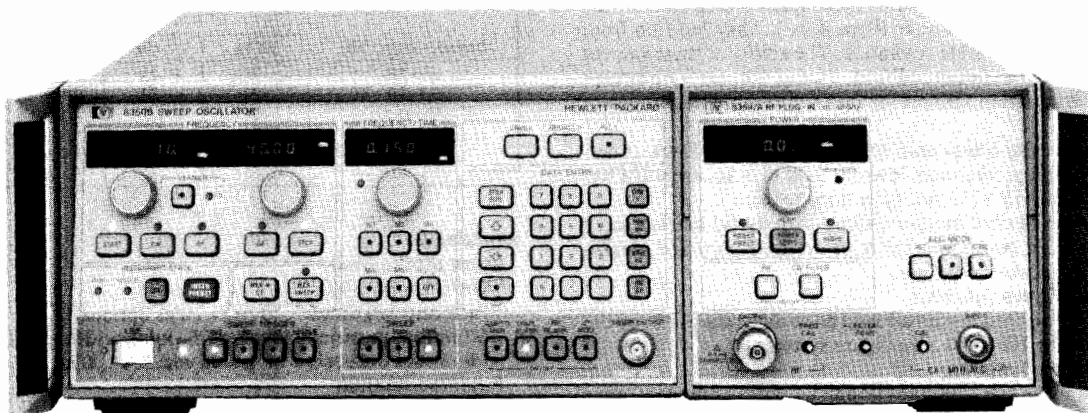

HP 8350B



### HP 8350 System

The HP 8350 is a powerful general-purpose source for swept microwave measurements, wideband CW signal generation and automatic testing. It incorporates the efficiency of microprocessor control with state-of-the-art YIG-tuned oscillators and GaAs FET amplifiers to produce a high performance sweep oscillator system ideally suited for either manual or automatic measurements.

You can easily configure a source to meet your application's frequency coverage and power requirements. Just combine the versatile HP 8350 mainframe with any of the 34 standard RF plug-ins (see table on page 416) and you are ready to make measurements. Both the advanced HP 83500 series plug-ins and the existing HP 86200 series plug-ins (via the HP 11869A adapter) are accepted by the HP 8350 mainframe.

### HP 8350 Mainframe

The HP 8350 has been designed to include many features that not only speed up and simplify measurements but also improve accuracy. In addition, it is compatible with HP network analyzers, counters, noise figure meters, power meters, and microwave link analyzers to provide complete solutions.

All function values (sweep limit frequencies, marker frequencies, etc.) are indicated on high resolution digital displays. Function values are easily modified using the appropriate knob, step keys, or data entry keyboard.

Five independent, continuously variable markers are available to note your measurement frequencies. The active marker frequency or the frequency difference between any two markers is read easily from a high resolution digital display. You can also use marker sweep to zoom in on a particular frequency span while retaining your original sweep limits.

Another particularly useful feature in making repetitive measurements is the HP 8350's Save/Recall Mode. Once the sweeper has been set for a particular measurement, all front panel settings (HP 8350 and HP 83500 series plug-in) can be *Saved* and later *Recalled* to repeat the measurement by accessing one of nine internal storage registers.

In the past, HP-IB programming of sweepers was limited to a series of CW frequencies. With the HP 8350 all front panel functions, e.g. sweeps, markers, sweep time, even output power (HP 83500 series plug-ins) can be programmed. This means there are no limitations in designing your own customized test systems. Utilizing the Learn Mode function, the HP 8350 becomes a "talker" as well as "listener" on the bus, transferring all manually entered front panel controls to the computer.

The HP 8350 provides full compatibility with the HP 8510 Network Analyzer and the HP 8757 Scalar Network Analyzers for convenient vector and scalar measurements. The HP 5343A Counter can be combined with the HP 8350 to measure Start, Stop, or marker frequencies with up to 100 kHz accuracy while sweeping. Microwave noise figure measurements may be made using the HP 8350 with the HP 8970 Noise Figure Meter. In addition, the HP 8350B, with an appropriate plug-in driving the HP 8349B microwave amplifier, provides up to +20 dBm of output power across a 2 to 18.6 GHz range.

### HP 83500 Series Plug-Ins

Broadband frequency coverage from 10 MHz to 40 GHz with high output power is provided in the HP 83500 series RF plug-ins. One plug-in, the HP 83597A covers the entire 10 MHz to 40 GHz frequency range with  $-50$  dBc harmonics from 1.5 to 20 GHz and  $-40$  dBc from 20 to 40 GHz. The HP 83595A/C, operate from 10 MHz to 26.5 GHz without sacrificing frequency accuracy ( $\pm 12$  MHz at 26.5 GHz). The HP 83595C also provides  $-50$  dBc harmonics and subharmonics from 1.5 to 26.5 GHz with +13 dBm to 20 GHz. The HP 83592C, 10 MHz to 20 GHz RF plug-in has  $-55$  dBc harmonics and subharmonics from 2 to 20 GHz. The HP 83550A provides +20 dBm of output power from 8.0 to 18.6 GHz, +18 dBm from 18.6 to 20.0 GHz and also has a built-in source module interface to drive the HP 83550-series millimeter-wave source modules. The 18 GHz to 26.5 GHz band is filled by the HP 83570A RF plug-in and boasts a 10 dBm power level (comparable to most BWOs). The millimeter-wave bands are covered by the HP 83550-series millimeter-wave source modules, frequency multipliers that provide coverage in the 26.5 to 40 GHz (HP 83554A), 33 to 50 GHz (HP 83555A), 40 to 60 GHz (HP 83556A), 50 to 75 GHz (HP 83557A), and 75 to 110 GHz (HP 83558A) bands by effectively extending the characteristics of an 11 to 20 GHz microwave source to the millimeter frequency range.

The HP 83500 series plug-ins offer output power level control previously unavailable on a swept source. Power level control is calibrated with 0.1 dB resolution and up to 80 dB range (with Opt 002 attenuator). Calibrated power sweeps are available for characterizing device performance as a function of power. Slope and internal leveling controls are standard on all units. The HP 83500 series plug-ins (except the HP 83572C) are also capable of power meter leveling with the HP 432A/B/C, 436A, 437A, and 438A power meters.

All HP 83500-series front-panel functions are HP-IB programmable including power level, so automatic test systems can characterize a device as a function of frequency and of input power level.

### HP 86200 Series Plug-Ins

Combining HP 86200-series plug-in (including one you might already own) with an HP 11869A adapter makes all the convenient digital controls, markers, and HP-IB capability of the HP 8350 immediately available. The HP 86200 series plug-ins are an attractive choice for economical single-band operation with the HP 8350. For measurements with HP microwave link analyzers, use specially characterized HP 86200 series plug-ins with the HP 8350 to create an upconverter for communications distortion measurements.

The HP 86290B/C plug-ins cover the 2-18 GHz frequency range with 10 dBm and 13 dBm of output power respectively. Frequency accuracy at 18 GHz is 30 MHz, exceeding that available on most single-band plug-ins. Both HP 83500 series and HP 86200 series plug-ins compatible with the HP 8350 mainframe are summarized in the table on page 416. Note that the HP 11869A Adapter is required with all HP 86200 series plug-ins.

- Accurate, high resolution, digital displays
- Five markers with marker  $\Delta$  and marker sweep
- Save/recall 9 complete front panel states

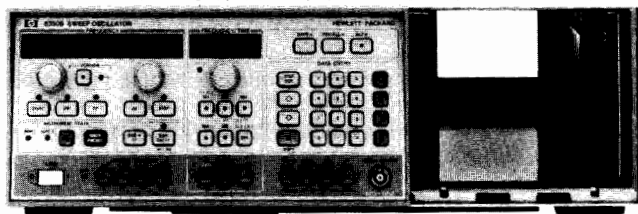

HP 8350B



## HP 8350B

Sweep Oscillator applications are greatly enhanced by the features of the HP 8350B. Along with the traditional swept and CW frequency functions, the HP 8350B adds extensive marker capabilities, versatile data entry and complete HP-IB programmability. Besides the popular HP 83500-series RF plug-ins, the HP 8350B also accepts the HP 86200-series plug-ins via the HP 11869A adapter. And the HP 8350B is directly compatible with such measurement systems as the HP 8510 vector network analyzer and the HP 8757 scalar network analyzers. Frequency accuracy is easily enhanced by using the HP 5343A counter to count the START, STOP, or ACTIVE MARKER frequencies.

The HP 8350B has three methods of changing function values: control knobs, keyboard entry, or step key entry.

Five markers are available with the HP 8350B. These markers, combined with the high resolution digital readout, make the accurate location of important frequency responses easy. A key marker feature, marker  $\Delta$ , computes the difference between any two markers. The markers can also modify the center frequency (marker  $\rightarrow$  CF) or the START/STOP frequency (Marker Sweep).

A necessity in making repetitive measurements or automatic tests is the Save/Recall feature. This feature supplies nine memory locations, each storing a complete front panel set-up. Nonvolatile memory is included so that all memories are retained even when line power is removed.

The HP 8350B makes "simultaneous" comparison of two separate frequency ranges or power levels easy via the alternate sweep mode. When the alternate sweep mode is activated, the HP 8350B alternates between the current front panel setting and any stored memory setting on successive sweeps. The output from this function may be processed through a network analyzer such as the HP 8757 and viewed on a two channel display.

All front panel controls (except the ac line switch) may be programmed or controlled via the HP-IB. The HP 8350B may interact as a listener or as a talker on the HP-IB.

A self test is performed at turn on or whenever the instrument preset function is activated. This function verifies that the HP 8350B is functioning properly. If there is a problem, error codes are displayed on the front panel to help locate the problem quickly to the board and component level.

## HP 8350B Specifications

### Frequency Control Functions

Refer to RF plug-in for frequency range, linearity and accuracy specifications.

**START/STOP sweep:** sweeps up from the START frequency to the STOP frequency.

**CF/ $\Delta$ F Sweep:** sweeps symmetrically upward, centered on CF.

**$\Delta$ F:** frequency width of sweep continuously adjustable from zero to 100% of frequency range.

- Accepts all HP 83500 series plug-ins
- Total HP-IB programmability
- Compatible with HP Network Analyzers

**CF Resolution:** 0.00038% (262,144 points across band).

**$\Delta$ F Resolution:** 0.1% of full band (1024 points across band), 0.012% of band for  $1/8$  of band or less, 0.0015% of band for  $1/64$  of band or less.

**Display resolution:** 5 digits.

**CW operation:** single frequency RF output.

**CW resolution:** same as CF.

**Vernier:** adjusts CW frequency or swept center frequency up to 0.05% of RF plug-in band being swept.

**Vernier resolution:** 4 ppm (64 points between each CW point; 262,144 points across band).

**Offset:** allows the CW frequency or center frequency to be offset by any amount up to the full range of the plug-in.

**Frequency markers:** five frequency markers are independently adjustable and fully calibrated over the entire sweep range. Amplitude or intensity markers available.

**Resolution:** 0.4% of selected sweep width (256 points/sweep).

### Sweep and Trigger Modes

**Internal:** sweep recurs automatically.

**Line:** sweep triggered by ac power line frequency.

**External trigger:** sweep is actuated by external trigger signal.

**Single:** selects mode and triggers a single sweep.

**Sweep time:** continuously adjustable from 10 ms to 100 seconds.

**Manual sweep:** continuous manual adjustment of frequency between end frequencies.

**External sweep:** sweep is controlled by external signal applied to SWP OUTPUT/SWP INPUT connector.

**Sweep output:** direct-coupled sawtooth, zero to approximately +10 volts, concurrent with swept RF output.

### Instrument State Storage

**Save n/recall n:** 9 different front panel settings can be stored.

**Alt n:** causes the RF output to alternate on successive sweeps between the current front panel setting and a setting stored in memory.

### Modulation

**External AM:** refer to RF plug-in specifications.

**Internal AM:** Selectable to 27.8 kHz or 1 kHz. On/off ratio, refer to RF plug-in specifications.

**External FM:** refer to RF plug-in specifications.

### Remote Programming (HP-IB)

The HP 8350B has both input and output capability. All front panel controls except the ac line power switch are programmable.

**Frequency resolution:** same as CF/ $\Delta$ F plus vernier.

**Power resolution:** see HP 83500 Series Plug-ins.

**HP-IB interface functions:** SH1, AH1, T6, L4, SR1, RL1, PPO, DC1, DT1, CO, E1.

### General Specifications

**Nonvolatile memory:** continuous memory that retains the contents of all instrument state storage registers, the HP-IB address, and current instrument state when ac line power is off.

**Operating temperature range:** 0°C to +55°C.

**Power:** 100, 120, 220 or 240 volts  $\pm$ 10%, 50 to 60 Hz (Option 400, 60 to 400 Hz). Approximately 375 volt-amperes including RF plug-in.

**Weight (not including RF unit):** Net 16.5 kg (36.4 lb). Shipping 22.7 kg (50 lb).

**Dimensions:** 425 mm wide, 133.3 mm high, 422 mm deep (16.75" x 5.25" x 16.6").

### Ordering Information

	Price
HP 8350B Sweep Oscillator Mainframe	\$5,000
Opt 803 HP 5343A Interface Cables	+\$60
Opt 910 Extra Manual	+\$80
Opt W30 Extended Repair Service. See page 723.	+\$125
Opt W32 Calibration Service. See page 723.	+\$360

For transit cases see page 721

# SWEEP OSCILLATORS

## HP 8350 Series: RF Plug-ins

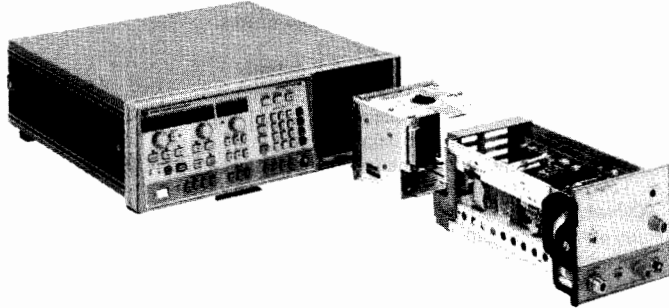

### HP 11869A Adapter

The HP 11869A adapter provides the electrical and mechanical interface between the HP 8350 and 86200 series plug-ins. All of the HP 8350's standard operating features, including HP-IB remote programming, are available. However, specific plug-in functions (output power level, RF on/off, etc.) cannot be controlled or remotely programmed by the HP 8350 mainframe.

See page 423 for HP 86200 series plug-in specifications.

### Plug-ins Compatible With The HP 11869A Adapter

The HP 11869A adapter attaches to the back of the HP 86200 series plug-in and is equipped with a switch for setting the specific interface code for the plug-in being used.

The following plug-ins will operate in the HP 8350 by using the HP 11869A.

HP 86220A <sup>1,2</sup>	HP 86240A/B/C	HP 86250A <sup>1</sup> /B <sup>1</sup> /C/D <sup>2</sup>
HP 86222A/B	HP 86241A <sup>1</sup>	HP 86251A <sup>3</sup>
HP 86230B <sup>1,2</sup>	HP 86242A <sup>1</sup> /C/D <sup>2</sup>	HP 86260A <sup>1</sup> /B <sup>1,3</sup> /C <sup>1,3</sup>
HP 86235A	HP 86245A	HP 86290A <sup>2</sup> /B/C

### Ordering Information

HP 11869A adapter

**Price**  
\$800

#### Options

Opt 004 Extension cables for plug-ins with rear panel RF output	+ \$200
Opt 006 Type N aux out interface connector for HP 86251A and 86290A <sup>2</sup> /B/C	+ \$200
Opt W30 Extended repair service. See page 723.	+ \$45

<sup>1</sup> Not compatible with 27.8 kHz square wave modulation.

<sup>2</sup> Models HP 86220A, 86230B, 86290A, 86250A/B/C, and 86242A/C are obsolete. However, existing models can interface to HP 8350B mainframe via the HP 11869A adapter.

<sup>3</sup> Requires a special PROM for the HP 11869A, which is shipped with every HP 86251A, 86260 B/C.

### RF Plug-in Summary

	HP Model number	Frequency range (GHz)	Leveled power output	CW Frequency accuracy (MHz)	Complete specifications on page
Broad-band Plug-ins	HP 83597A	0.01-40	1 mW	±20	419
	HP 83596A	2.4-40	1 mW	±20	419
	HP 83595A	0.01-26.5	2.5 mW	±12	417/418
	HP 83595C	0.01-26.5	10 mW/20mW <sup>1</sup>	±12	417/418
	HP 83594A	2-26.5	2.5 mW	±12	417/418
	HP 83592A/B	0.01-20	10 mW/20 mW <sup>1</sup>	±10	417/418
	HP 83592C	0.01-20	2.5 mW/4 mW <sup>2</sup>	±10	417/418
	HP 83590A	2-20	10 mW	±10	417/418
	HP 83525A/B	0.01-8.4	20 mW/10 mW	±15/12	420
	HP 83522A	0.01-2.4	20 mW	±5	420
	HP 86222A/B	0.01-2.4	20 mW	±10	423
	HP 86290B	2-18.6	10 mW	±30	423
HP 86290C	2-18.6	20 mW	±30	423	
Straddle-band Plug-ins	HP 83540A/B	2-8.4	40 mW/20 mW	±12	420
	HP 86240A	2-8.4	40 mW	±25	423
	HP 86240B	2-8.4	20 mW	±25	423
	HP 86240C	3.6-8.6	40 mW	±25	423
	HP 86251A	7.5-18.6	10 mW	±20 <sup>3</sup>	423
	HP 83550A	8.0-20.0	100 mW/63 mW <sup>4</sup>	±20	420
Single-band Plug-ins	HP 86235A	1.7-4.3	40 mW	±20	423
	HP 86241A	3.2-6.5	5 mW	±30	423
	HP 86242D	5.9-9	10 mW	±35	423
	HP 83545A	5.9-12.4	50 mW	±20	420
	HP 86245A	5.9-12.4	50 mW	±40	423
	HP 86250D	8.0-12.4	10 mW	±40	423
	HP 86260B	10-15.5	10 mW	±50	423
	HP 86260A	12.4-18	10 mW	±50	423
	HP 86260C	17-22	10 mW	±50	423
	HP 83570A	18-26.5	10 mW	±30	420
	HP 83572C	26.5-40	4 mW (Opt 001)	±100	420

NOTE: The HP 11869A Adapter is required to interface HP 86200 series plug-ins with the HP 8350B mainframe.

<sup>1</sup> 20 mW to 18 GHz (HP 83592B) and 20mW to 20 GHz (HP 83595C).

<sup>2</sup> HP 83592C: 4 mW to 18.6 GHz.

<sup>3</sup> When installed in HP 8350 with HP 11869A Adapter.

<sup>4</sup> HP 83550A: 100 mW to 18.6 GHz.



# SWEEP OSCILLATORS

## Model 8350 Series: Broadband RF Plug-Ins

417

HP 83595A/C, 83592A/B/C, 83594A, 83590A

- Calibrated output power with 0.1 dB resolution
- +13 dBm from 0.01 to 20.0 GHz
- 12 MHz frequency accuracy at 26.5 GHz

- -55 dBc harmonics and subharmonics from 3.5 to 20 GHz
- Internal leveling and slope standard
- HP-IB

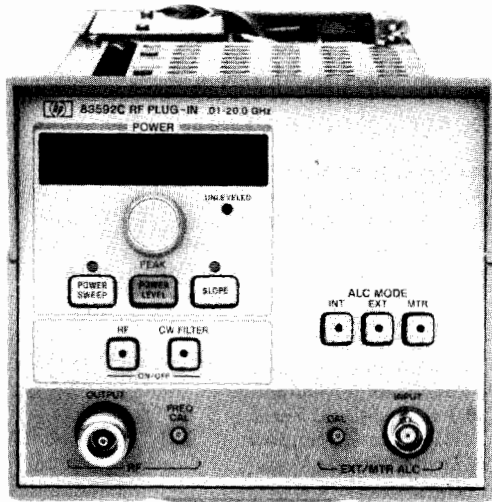

HP 83592C



The HP 83590 series plug-ins feature wideband frequency coverage, while maintaining narrowband precision, with excellent frequency accuracy and stability. At 26.5 GHz the HP 83595A/C maintain an accuracy of  $\pm 12$  MHz. The HP 83595C does not sacrifice excellent performance for broadband high frequency coverage; the output power is internally leveled for a minimum of +13 dBm to 20 GHz and +10 dBm to 26.5 GHz, with  $< -50$  dBc harmonics and subharmonics from 1.5 to 26.5 GHz. The 83592B offers +13 dBm internally leveled output power to 18.6 GHz, while maintaining  $\pm 0.9$  dB flatness. The HP 83592C provides a clean test signal with -55 dBc harmonic and subharmonic levels (3.5-20 GHz) to maximize dynamic range. Power output capabilities have been expanded to provide power sweep and slope control. In addition, the HP 83590 series plug-ins are completely HP-IB programmable.

The most outstanding feature of the HP 83590 series plug-ins is their broad frequency range. Innovative technology is used to create this precision frequency range. The principle behind this technology is the Switched YIG Tuned Multiplier circuit (SYTM). The YTM circuit uses the output of a fundamental oscillator to drive a high-efficiency multiplier that has been integrated with a tracking YIG filter in order to create and select high order harmonics to be used as output frequencies.

A figure of merit for the HP 83590 series is their flat output power over the entire frequency range. The output power is internally leveled within 0.9 dB with a displayed resolution of 0.1 dB. The power level may be controlled to a minimum settable power level of -5 dBm (-2 dBm for the HP 83592B and HP 83595C). This level may be extended to -75 dBm on the HP 83592A and HP 83590A or to -72 dBm on the HP 83592B with Option 002 (70 dB Step Attenuator), or to -60 dBm on the HP 83592C, the HP 83595A and HP 83594A with Option 002 (55 dB Step Attenuator), or to -62 dBm on the HP 83595C with Option 002 (60 dB Step Attenuator).

Since power parameters are critical to high frequency measurements, the HP 83590 Series (along with all HP 83500 series plug-ins) offer many modes of power output. In addition to a single power output, the HP 83590 Series offer a Power Sweep function. The Power Sweep function sweeps a power range for characterizing level sensitive devices like amplifiers and transistors. The Slope mode is supplied to provide compensation for cable or test set losses. In all these modes the power output is internally monitored and leveled. If preferred, the power may be externally leveled. The HP 83590 Series plug-ins are capable of power meter leveling with the HP 432A/B/C, 436A, and 438A power meters.

HP-IB programmability is an essential feature when one of the HP 83590 series is used in automatic test systems. For example, the automated tests of amplifiers for gain compression are possible. These plug-ins are completely programmable, which means the power mode may be selected and the power level may be set with .01 dB resolution.

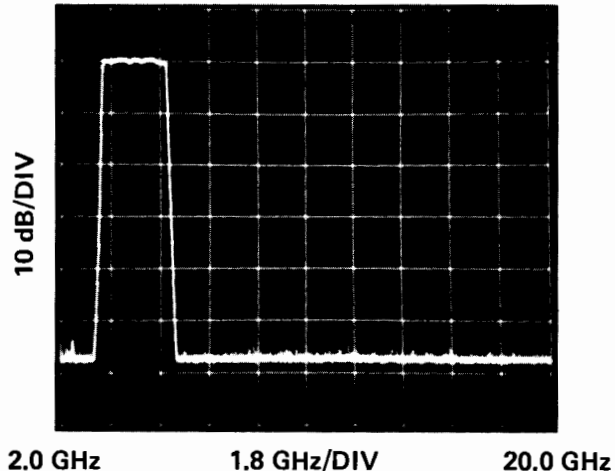

### Output Characteristics

#### Output Power Resolution

**Displayed:** 0.1 dB

**Programmable/Settable:** 0.01 dB

#### Power Sweep

(with Option 002 Power Sweep cannot cross an attenuator step)

**Calibrated Range:** >9 dB

**Accuracy** (including linearity), typical:  $\pm 1.5$  dB

**Power Slope** (with Option 002 Power Slope cannot cross an attenuator step)

**Calibrated Range:** Up to 5 dB/GHz; up to 15 dB for full sweep

**Linearity**, typical: <0.2 dB

**Residual AM in 100 kHz Bandwidth**, typical: -50 dBc

**Source Output VSWR** (50 ohm nominal) typical: <1.9

### Modulation Characteristics

#### External AM

**Frequency Response**, typical: 100 kHz

**Range of Amplitude Control**, typical: 15 dB

**Sensitivity**, typical: 1 dB/V

#### Internal Square Wave Modulation

1 kHz or 27.8 kHz square wave modulation selectable by internal jumper in HP 8350B. The 27.8 kHz modulation ensures operation with all Hewlett-Packard scalar network analyzers.

**On/Off Ratio:** >30 dB

**Symmetry:** 40/60

#### External Pulse Modulation

(HP 83592A/B/C, 83595A specifications only)

**Pulse Input:** TTL compatible

**Rise/Fall Time**, typical: <50 nsec

#### Minimum RF Pulse Width:

**Internally Leveled**, typical: <5  $\mu$ sec

**Unleveled**, typical: 200 nsec (0.01-2.5 GHz)

100 nsec (2.5-20 GHz or 26.5 GHz)

#### External FM

##### Maximum Deviations for Modulation Frequencies:

DC to 100 Hz:  $\pm 75$  MHz

100 Hz to 1 MHz:  $\pm 7$  MHz

1 MHz to 2 MHz:  $\pm 5$  MHz

2 MHz to 10 MHz:  $\pm 1$  MHz

**Sensitivity** (switch selectable), typical

FM Mode: -20 MHz/V

Phase-lock Mode: -6 MHz/V

# SWEEP OSCILLATORS

## Model 8350 Series: Broadband RF Plug-Ins (cont'd)

HP 83595A/C, 83592A/B/C, 83594A, 83590A

### General Specifications

#### Minimum Sweep Time

- 10 msec for single band
- HP 83590A, 83592A/B/C: 25 msec for full sweep
- HP 83594A, 83595A/C: 30 msec for full sweep
- HP 83592C: 35 msec for full sweep

#### Auxiliary Output

(rear panel fundamental oscillator output, nominally 0 dBm):

- HP 83590A, 83594A: 2.0-7.0 GHz
- HP 83592A/B/C, 83595A: 2.3-7.0 GHz

#### Frequency Reference Output

(rear panel BNC output, switch selectable):

- 1 V/GHz  $\pm$  25 mV (<18 GHz)
- 0.5 V/GHz  $\pm$  25 mV (< 20 GHz or <26.5 GHz)

#### RF Output Connector

- HP 83590A, 83592A/B/C: Type N female
- HP 83594A, 83595A: Type APC 3.5 male

#### Weight:

Net 6.0 kg (13.2 lb), Shipping 9.2 kg (20 lb)

### Ordering Information

	<b>Price</b>
HP 83590A 2.0 to 20 GHz RF Plug-in	\$15,700
HP 83592A 0.01 to 20 GHz RF Plug-in	\$18,200
HP 83592B 0.01 to 20 GHz (high power) RF Plug-in	\$20,200
HP 83592C 0.01 to 20 GHz (low harmonics) RF Plug-in	\$20,200
HP 83594A 2.0 to 26.5 GHz RF Plug-in	\$22,200
HP 83595A 0.01 to 26.5 GHz RF Plug-in	\$24,000
HP 83595C 0.01 to 26.5 GHz RF Plug-in (high power, low harmonics)	\$27,000
Opt 002 70 dB Step Attenuator (HP 83590A, 83592A/B)	+\$1,500
55 dB Step Attenuator (HP 83592C, 83594A, 83595A)	
60 dB Step Attenuator (HP 83595C)	+\$1,800
Opt 004 Rear Panel RF Output	+\$200
Opt W30 Two Additional Years Return-to-HP Support	See HP 8350B Data Sheet
Opt W32 Two Additional Years Return-to-HP Calibration	See HP 8350B Data Sheet

	Band 0	Band 1	Band 2	Band 3	Band 4	Full Band
<b>Frequency Characteristics</b>						
<b>Range</b>						
HP 83590A	-	2-7	7-13.5	13.5-20	-	2-20
HP 83592A/B/C	.01-2.4	2.4-7	7-13.5	13.5-20	-	.01-20
HP 83594A	-	2-7	7-13.5	13.5-20	20-26.5	2-26.5
HP 83595A/C	.01-2.4	2.4-7	7-13.5	13.5-20	20-26.5	.01-26.5
<b>Accuracy (MHz, 25°C)</b>						
CW Mode	$\pm 5$	$\pm 5$	$\pm 10$	$\pm 10$	$\pm 12$	
All Sweep Modes (sweep time >100 ms)	$\pm 15$	$\pm 20$	$\pm 25$	$\pm 30$	$\pm 35$	$\pm 50$
<b>Linearity (MHz), typical</b>						
	$\pm 2$	$\pm 2$	$\pm 4$	$\pm 6$	$\pm 10$	$\pm 10 (\pm 15)^1$
<b>Stability, typical</b>						
With Temperature (MHz/°C)	$\pm 0.2$	$\pm 0.2$	$\pm 0.4$	$\pm 0.6$	$\pm 0.8$	
With 10 dB Power Change (kHz)	$\pm 200$	$\pm 200$	$\pm 400$	$\pm 600$	$\pm 800$	
With 3:1 Load SWR (kHz)	$\pm 100$	$\pm 100$	$\pm 200$	$\pm 300$	$\pm 400$	
With Time <sup>2</sup> (kHz)	$\pm 100$	$\pm 100$	$\pm 200$	$\pm 300$	$\pm 400$	
<b>Residual FM (kHz peak, 10 Hz-10 kHz bandwidth)</b>						
	<5	<5	<7	<9	<12	
<b>Output Characteristics</b>						
Maximum Levelled Power (mW, 25°C)	10 (20 <sup>3</sup> )	10 (20 <sup>3</sup> , 4 <sup>4</sup> )	10 (20 <sup>3</sup> , 4 <sup>4</sup> )	10 (2.5 <sup>4</sup> , 20 <sup>9</sup> )	2.5 (10 <sup>9</sup> )	10 (2.5 <sup>4</sup> )
With Option 002	10 (16 <sup>3</sup> , 20 <sup>9</sup> )	7 (14 <sup>4</sup> , 2.8 <sup>9</sup> , 16 <sup>6</sup> )	6.3 (13 <sup>3</sup> , 2.5 <sup>4</sup> , 16 <sup>6</sup> )	5 (1.4 <sup>4</sup> , 16 <sup>6</sup> )	1.25 (6 <sup>6</sup> )	5 (1.25 <sup>4</sup> , 1.4 <sup>4</sup> , 6 <sup>6</sup> )
<b>Power Level Accuracy (dB)</b>						
Internally Levelled	$\pm 1.5$	$\pm 1.3$	$\pm 1.3$	$\pm 1.4$	$\pm 1.7$	$\pm 1.5 (\pm 1.8)^9$
<b>Power Variation (dB, max specified power)</b>						
Internally Levelled	$\pm 0.9$	$\pm 0.7$	$\pm 0.7$	$\pm 0.8$	$\pm 0.9$	$\pm 0.9 (\pm 1.0)^9$
Externally Levelled <sup>8</sup>	$\pm 0.2 (0.3)^8$	$\pm 0.2 (0.25^8, 0.3^8)$	$\pm 0.2 (0.25^8, 0.3^8)$	$\pm 0.2 (0.25^8, 0.3^8)$	$\pm 0.2 (0.25^8, 0.3^8)$	
<b>Minimum Settable Power (dBm)</b>						
With Option 002	-5 (-2 <sup>3</sup> ) -60 (-62 <sup>9</sup> , -72 <sup>3</sup> , -75 <sup>6</sup> )	-5 (-2 <sup>3</sup> ) -60 (-62 <sup>9</sup> , -72 <sup>3</sup> , -75 <sup>6</sup> )	-5 (-2 <sup>3</sup> ) -60 (-62 <sup>9</sup> , -72 <sup>3</sup> , -75 <sup>6</sup> )	-5 (-2 <sup>3</sup> ) -60 (-62 <sup>9</sup> , -72 <sup>3</sup> , -75 <sup>6</sup> )	-5 (-2 <sup>3</sup> ) -60 (-62 <sup>9</sup> , -72 <sup>3</sup> , -75 <sup>6</sup> )	-5 (-2 <sup>3</sup> ) -60 (-62 <sup>9</sup> )
<b>Spurious Signals (dBc, max specified power)</b>						
Harmonically Related	<-25 (<-20 <sup>9</sup> , <-45 <sup>7</sup> )	<-25 (<-50 <sup>9</sup> , <-55 <sup>7</sup> )	<-25 (<-50 <sup>9</sup> , <-55 <sup>7</sup> )	<-25 (<-50 <sup>9</sup> , <-55 <sup>7</sup> )	<-20 (<-50 <sup>9</sup> )	
Non-harmonics	<-25 (<-40 <sup>1</sup> )	<-50 (<-55 <sup>1</sup> )	<-50 (<-55 <sup>1</sup> )	<-50 (<-55 <sup>1</sup> )	<-50	

<sup>1</sup> HP 83594A, 83595A specifications only.

<sup>2</sup> 10 minute period after one hour warm-up at same frequency.

<sup>3</sup> HP 83592B specifications only.

<sup>4</sup> HP 83592C specifications only.

<sup>5</sup> Negative crystal detector (sweep time > 100 msec) or HP 432A/B/C, 436A or 438A Power Meter (sweep time  $\geq$  100 sec), excludes coupler/detector variation.

<sup>6</sup> HP 83590A, HP 83592A specifications only.

<sup>7</sup> HP 83592C only: <-25 dBc (0.1-1.4 GHz)  
<-45 dBc (1.4-2.4 GHz)  
<-50 dBc (2.4-3.5 GHz)  
<-55 dBc (3.5-20 GHz)

<sup>8</sup> HP 83594A specifications only.

<sup>9</sup> HP 83595C specifications only.

# SWEEP OSCILLATORS

## Model 8350 Series: Broadband RF Plug-ins

419

HP 83597A, 83596A

- 10 MHz to 40 GHz frequency coverage with the 2.4 mm coaxial connector
- -50 dBc harmonics and subharmonics from 1.5 to 20 GHz, -40 dBc from 20 to 40 GHz

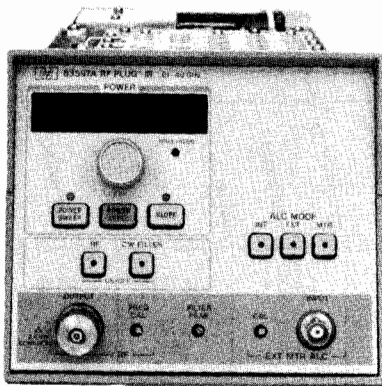

HP 83597A

The HP 83597A and 83596A RF plug-ins provide the highest performance and reliability available up to 40 GHz from a swept source. They feature high output power, as well as excellent harmonic performance. They also incorporate the 2.4 mm connector which makes high performance broadband coaxial measurements possible. The superiority of the 2.4 mm connector lies in its ruggedness, repeatable performance and excellent match over the entire frequency range.

A 40 GHz broadband swept scalar measurement system is easy to configure using this sweep oscillator with the HP 8757A/C/E Scalar Network Analyzers, and the appropriate 2.4 mm scalar network analyzer accessories. With -50 dBc of harmonic and subharmonic suppression from 1.5 to 20 GHz, and -40 dBc from 20 to 40 GHz, these plug-ins are the ideal choice for scalar network analysis.

The broadband frequency coverage and high output power of the HP 83597A and 83596A plug-ins make them ideal as local oscillators for down-converting high frequency signals to a lower intermediate frequency. These plug-ins provide the broadest frequency coverage for mixer measurement systems or coaxial noise figure measurements with the HP 8970B Noise Figure Meter.

The outstanding performance of the HP 83597A and 83596A plug-ins make them especially attractive as stand-alone sources for various signal generation and simulation applications. Frequency accuracies of better than  $\pm 5$  to  $\pm 20$  MHz are specified depending on the frequency of operation. These plug-ins additionally have very flexible amplitude, frequency and pulse modulation capabilities.

### Output Characteristics

#### Output Power Resolution

Displayed: 0.1 dB

Programmable/Settable:  $\pm 0.01$  dB

**Minimum Settable Power:** -15 dBm

#### Power Variation:

Externally Leveled (excluding coupler/detector variation)

Negative Crystal detector<sup>2</sup> or HP 432A/B/C, 436A or 438A

Power Meter<sup>9</sup>:  $\pm 0.2$  dB, typical

#### Power Sweep

Calibrated Range: > 19 dB (< 18.6 GHz), > 15 dB (> 18.6 GHz)

Accuracy (including linearity):  $\pm 1.5$  dB, typical

Resolution (displayed): 0.1 dB, typical

#### Power Slope

Calibrated Range: up to 5 dB/GHz, up to 15 dB for full sweep

Linearity: 0.2 dB, typical

Resolution (displayed): 0.01 dB/GHz, typical

**Residual AM in 100 kHz Bandwidth:** -50 dBc, typical

#### Source Output VSWR

(50 Ohm, nominal impedance): < 2.0:1, typical

#### Modulation Characteristics

##### External AM

Frequency Response: 100 kHz, typical

Maximum Input: 15V

Range of Amplitude Control: 15 dB, typical

Sensitivity: 1 dB/V, typical

Input Impedance: approximately 25 k $\Omega$

##### Internal Square Wave Modulation

1 kHz or 27.778 kHz square wave modulation selectable by internal jumper in HP 8350B. The 27.778 kHz modulation ensures operation with all Hewlett-Packard scalar network analyzers.

On/Off Ratio: > 30 dB

##### External Pulse Modulation:

Rise/Fall Time (neglecting overshoot): < 50 nsec, typical

Minimum RF Pulse Width:

Internally Leveled: < 1.5  $\mu$ sec, typical

Unleveled: < 1  $\mu$ sec, typical

On/Off Ratio: > 60 dB, typical

##### External FM

Maximum Deviations for Modulation Frequencies:

DC to 100 Hz:  $\pm 75$  MHz (cross-over coupled),  
 $\pm 12$  MHz (direct coupled)

100 Hz to 1 MHz:  $\pm 7$  MHz

1 MHz to 2 MHz:  $\pm 5$  MHz

2 MHz to 10 MHz:  $\pm 1$  MHz

Sensitivity (switch selectable):

FM Mode: -20 MHz/V, typical

Phase-lock Mode: -6 MHz/V, typical

#### General Specifications

**Minimum Sweep Time:** 30 ms for a single band, 75 ms for < 20 GHz sweep width, 150 ms for > 20 GHz sweep width.

**Auxiliary Output:** Rear panel 2.3-7.0 GHz fundamental oscillator output, nominally 0 dBm.

**Frequency Reference Output:** Switch selectable 0.5 V/GHz (0.01-38 GHz) or 0.25V/GHz (0.01-40 GHz),  $\pm 25$  mV (< 2.4 GHz) or  $\pm 100$  mV (> 2.4 GHz).

**RF Output Connector:** Type 2.4 mm male.

**Weight:** Net 6.5 kg (14.4 lb), Shipping 9.5 kg (21 lb).

#### Ordering Information

HP 83597A 10 MHz to 40 GHz RF Plug-In \$33,500

HP 83596A 2.4 GHz to 40 GHz RF Plug-In \$30,000

Opt 002 55 dB Step Attenuator +\$2,700

Opt 004 Rear Panel RF Output +\$200

Opt W30 Extended repair service see page 723 See HP 8350B

Opt W32 Calibration service see pg 723 Data Sheet

	Band 0	Band 1	Band 2	Band 3	Band 4	Full Band
<b>Frequency Characteristics</b>						
<b>Range</b>						
HP 83597A	0.01-2.4 GHz	2.4-7.0 GHz	7.0-13.5 GHz	13.5-20.0 GHz	20.0-40.0 GHz	0.01-40.0 GHz
HP 83596A		2.4-7.0 GHz	7.0-13.5 GHz	13.5-20.0 GHz	20.0-40.0 GHz	2.4-40.0 GHz
<b>Accuracy<sup>1</sup></b>						
CW Mode:	$\pm 5$ MHz	$\pm 5$ MHz	$\pm 10$ MHz	$\pm 10$ MHz	$\pm 20$ MHz	$\pm 75$ MHz
All Sweep Modes: <sup>2</sup>	$\pm 15$ MHz	$\pm 20$ MHz	$\pm 25$ MHz	$\pm 30$ MHz	$\pm 50$ MHz	
<b>Residual FM (peak)<sup>3</sup>:</b>	< 5 kHz	< 5 kHz	< 7 kHz	< 9 kHz	< 18 kHz	
<b>Output Characteristics</b>						
<b>Maximum Leveled Power<sup>1,4</sup></b>	2.5 mW	2.5 mW	2.5 mW	2.5 mW (< 18.6 GHz) 1 mW (> 18.6 GHz)	1 mW	
<b>Power Level Accuracy<sup>1,5,6</sup></b>	$\pm 1.5$ dB	$\pm 1.3$ dB	$\pm 1.3$ dB	$\pm 1.4$ dB	$\pm 2.0$ dB	$\pm 2.0$ dB
<b>Power Variation<sup>1,6</sup></b>	$\pm 0.9$ dB	$\pm 0.7$ dB	$\pm 0.7$ dB	$\pm 0.8$ dB	$\pm 1.2$ dB	$\pm 1.3$ dB
<b>Spurious Signals<sup>7</sup></b>						
Harmonics and Subharmonics	< -25 dBc (< 1.5 GHz) < -50 dBc (> 1.5 GHz)	< -50 dBc	< -50 dBc	< -50 dBc	< -40 dBc <sup>8</sup>	
Non-harmonics:	< -25 dBc	< -50 dBc	< -50 dBc	< -50 dBc	< -50 dBc	

<sup>1</sup> 25°C  $\pm 5^\circ$ C.

<sup>2</sup> For sweep times  $\geq 100$  ms.

<sup>3</sup> 10 Hz to 10 kHz bandwidth, CW mode with CW filter on.

<sup>4</sup> Typically degrades 0.1 dB/ $^\circ$ C above 25°C.

<sup>5</sup> Includes power level variations.

<sup>6</sup> Degrades typically  $\pm 0.05$  dB/ $^\circ$ C outside the 20°C-30°C range.

<sup>7</sup> At specified maximum leveled power.

<sup>8</sup> Typically < -40 dBc above 40 GHz.

<sup>9</sup> For sweep times  $\geq 10$  sec and  $\geq 2.5$  sec/GHz.

# SWEEP OSCILLATORS

## HP 8350 Series RF Plug-Ins

	Broadband			Straddle-Band			Single-Band		
	HP 83522A <sup>1</sup>	HP 83525A <sup>1</sup>	HP 83525B <sup>1</sup>	HP 83540A	HP 83540B	HP 83550A	HP 83565A	HP 83570A <sup>2</sup>	HP 83572C <sup>3</sup>
<b>HP 83500 Series Plug-Ins: Specifications Summary</b>									
<b>Frequency Characteristics</b>									
Range (GHz)	0.01-2.4	0.01-8.4	0.01-8.4	2-8.4	2-8.4	8-20	5.9-12.4	18-26.5	26.5-40
Accuracy (MHz, 25°C)									
CW Mode	±5	±15 <sup>4</sup>	±12 <sup>4</sup>	±12	±12	±20	±20	±30	±100
All Sweep Modes (sweep time >100 ms)	±15	±20 <sup>4</sup>	±20 <sup>4</sup>	±20	±20	±50	±35	±55	±150
Residual FM (kHz peak, 10 Hz-10 kHz bandwidth)	<5	<9 <sup>4</sup>	<7 <sup>4</sup>	<7	<7	<25 <sup>13</sup>	<15	<30	<60
<b>Output Characteristics</b>									
Maximum Leveled Power (mW, 25°C)	>20	>20	>10	>40	>20	>100 <sup>5</sup>	>50	>10	>5 <sup>6</sup>
Power Level Accuracy (dB)									
Internally Leveled	±1	±1.5	±1.5	±1.5	±1.5	±1.5	±1	±1.8	±1.5 <sup>7</sup>
Power Variation (dB, at max specified power)									
Internally Leveled	±0.25	±1	±1	±1	±1	±1.25	±0.6	±1.4	±3 <sup>6</sup>
Externally Leveled, typical (excluding coupler/detector variations)	±0.1	±0.1	±0.1	±0.1	±0.1	±0.1	±0.1	±0.1	±0.2
Spurious Signals (dBc, at max specified power)									
Harmonically Related	<-25	<-20	<-45 <sup>8</sup>	<-20	<-45	<-20 <sup>9</sup>	<-30 <sup>9</sup>	<-25	<-20
Non-harmonics	<-25	<-60 <sup>9</sup>	<-60 <sup>9</sup>	<-60	<-60	<-50	<-60	<-50	<-50
Source SWR, typical (50 ohms nominal, internally leveled)	<1.5	<1.6 <sup>8</sup>	<1.6 <sup>8</sup>	<1.6	<1.6	<2.5	<1.6	<2.5	<1.5 <sup>7</sup>
<b>Modulation Characteristics</b>									
External Pulse, typical									
Rise/Fall Time (ns)	n/a	20 <sup>4</sup>	20 <sup>4</sup>	20	20	25	15	20	300/50 <sup>11</sup>
Minimum RF Pulse Width									
Leveled (μs)	n/a	1 <sup>4</sup>	5 <sup>4</sup>	1	5	1	1	1	n/a
Unleveled (ns)	n/a	100 <sup>4</sup>	100 <sup>4</sup>	100	100	100	100	100	500 <sup>11</sup>
External FM									
Maximum Deviation (MHz)									
DC to 100 Hz Rates	±75	±75	±75	±75	±75	±75	±75	±75	±150
100 Hz to 200 kHz Rates	±7	±7	±7	±7	±7	±12	±7	±7	±3.5
200 kHz to 1 MHz Rates	±7	±7	±7	±7	±7	±12	±7	±7	n/a
1 MHz to 2 MHz Rates	±5	±5	±5	±5	±5	±12	±5	±5	n/a
2 MHz to 6 MHz Rates	±1	±1	±1	±1	±1	±12	±1	±1	n/a
6 MHz to 10 MHz Rates	±1	±1	±1	±1	±1	±1	±1	±1	n/a
Sensitivity (MHz/volt), typical	-20/-6	-20/-6	-20/-6	-20/-6	-20/-6	-20/-6	-20/-6	-20/-6	-20/-6
External AM									
Frequency response (kHz), typical	100	100	100	100	100	100	100	100	10
Range (dB), typical	>15	>15	>15	>15	>15	>20	>15	>11	>11 <sup>7</sup>
Sensitivity (dB/volts)	+1	+1	+1	+1	+1	+1	+1	+1	+1 <sup>7</sup>
Internal AM (1 kHz/27.8 kHz square wave)									
On/Off Ratio (dB)	>30	>30	>30	>30	>30	>30	>40	>25	>20 <sup>11</sup>
<b>Prices</b>									
Plug-in	\$8,400	\$13,100	\$14,300	\$9,900	\$10,750	\$16,500	\$10,100	\$13,000	\$19,200
With Opt 001 (Calibrated External Leveling)	n/a	n/a	n/a	n/a	n/a	n/a	n/a	n/a	+ \$1,600
With Opt 002 (70 dB Attenuator)	+ \$1,005	+ \$1,105	+ \$1,105	+ \$1,105	+ \$1,105	+ \$1,305 <sup>12</sup>	+ \$1,105	n/a	n/a
With Opt 004 (Rear Panel RF Output)	+ \$200	+ \$200	+ \$200	+ \$200	+ \$200	+ \$200	+ \$200	n/a	n/a
With Opt 006 (Int. Sq. Wave Mod. & Ext. Pulse Mod.)	n/a	n/a	n/a	n/a	n/a	n/a	n/a	n/a	+ \$1,800
With Opt W30 (Two Years Extended Service)	+ \$190	+ \$285	+ \$285	+ \$215	+ \$215	+ \$380	+ \$250	+ \$320	+ \$425
With Opt W32 (Calibration Service See Pg 723)	+ \$1300	+ \$1265	+ \$1420	+ \$1135	+ \$970	+ \$1405	+ \$1215	+ \$800	+ \$895

<sup>1</sup> Enhanced frequency accuracy is provided by internal crystal markers of 10 MHz and 50 MHz (over full range for HP 83522A, and below 2 GHz for HP 83525A/B). 1 MHz harmonic markers are available below 1 GHz.

<sup>2</sup> WR42 waveguide RF output connector type.

<sup>3</sup> WR28 waveguide RF output connector type.

<sup>4</sup> Specifications apply from 2-8.4 GHz only. 0.01-2 GHz specifications are the same as the HP 83522A plug-in.

<sup>5</sup> 63 mW from 18.6-20 GHz.

<sup>6</sup> Unleveled output power.

<sup>7</sup> Externally leveled (requires option 001 which consists of a calibrated crystal detector, external coupler, and BNC cable).

<sup>8</sup> Specifications apply only from 2-8.4 GHz.

<sup>9</sup> -15 dBc from 8-11 GHz.

<sup>10</sup> -17 dBc from 5.9-7 GHz.

<sup>11</sup> Requires option 006 which provides internal square wave modulation and external pulse and square wave modulation capabilities.

<sup>12</sup> 50 dB step attenuator.

<sup>13</sup> 20 Hz - 15 kHz bandwidth.

# SWEEP OSCILLATORS

## HP 83550 Series Millimeter-Wave Source Modules

HP 83554A, 83555A, 83556A, 83557A and 83558A

- 26.5 to 110 GHz frequency range
- Leveled high output power
- Can be driven by many HP microwave sources

- Source module remotable up to a meter length
- Low entry cost



### High Output Power

Leveled output power from the source modules is rated at +8 dBm for the HP 83554A, +3 dBm for the HP 83555A, +3 dBm for the HP 83556A, +3 dBm for the HP 83557A, and -1 dBm for the HP 83558A. This high output power can permit the source module to serve as a mixer LO in some applications, and also expands the available dynamic range in frequency response measurements.

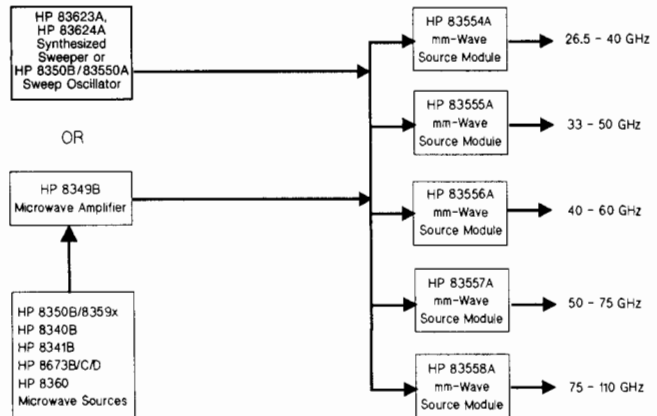

The three HP 83550 series millimeter-wave source modules provide a simple approach to extend the frequency range of 11 to 20 GHz sources to cover 26.5 to 40 GHz (HP 83554A), 33 to 50 GHz (HP 83555A) 40 to 60 GHz (HP 83556A) 50-75 GHz (HP 83557A), and 75-110 GHz (HP 83558A) bands. The HP 83550 series source modules offer leveled high output power, full waveguide band frequency coverage, and the high frequency accuracy and resolution of the driving microwave source.

As shown in Figure 1, there are 3 basic ways of configuring a millimeter-wave source to best suit your specific needs. Your choice can range from a sophisticated synthesized sweeper (HP 83623A or HP 83624A) to a sweep oscillator (HP 8350B/8359x) with an HP 8349B amplifier.

### Pulse, AM and FM Modulation

The high performance pulse modulators of the HP synthesized sources offer >80 dB ON/OFF ratio and <50 ns rise and fall times. Pulse amplitudes are leveled for pulse widths as narrow as 1  $\mu$ s.

The HP 8340B/8341B also feature dc-coupled AM with a 3 dB bandwidth of 100 kHz. Pulse and amplitude modulation can be used to simultaneously simulate antenna scan patterns.

FM rates between 100 Hz and 10 MHz may be applied to the HP 8673B/C/D synthesizer input to achieve deviations up to 20 MHz (HP 83554A) and 30 MHz (HP 83555A, 83556A), 40 MHz (HP 83557A) and 60 MHz (HP 83558A) at millimeter-wave frequencies.

### All at a Lower Cost

The HP 83550-series source modules combines performance and quality with a low cost of entry. This is possible because the source modules are backward-compatible with existing HP microwave sources. Thus, you can generate a full waveguide band of millimeter-wave frequencies for just the cost of the HP 8349B and a source module. Also, the cost of ownership to you is reduced even further by the two-year warranty on the microcircuits of the HP 83550-series source modules and the HP 8349B microwave amplifier.

HP 83554A Output Characteristics <sup>1</sup>	HP 8350B/83550A	HP 8350B/83590 Series/8349B	HP 8340B/8349B, HP 8341B/8349B	HP 8673B/C/D/8349B
<b>Maximum Leveled Power</b> (25°C±5°C)	+8 dBm, 26.5-37.2 GHz +7 dBm, 37.2-40.0 GHz	+8 dBm, 26.5-37.2 GHz +7 dBm, 37.2-40.0 GHz	+8 dBm, 26.5-37.2 GHz +7 dBm, 37.2-40.0 GHz	+8 dBm, 26.5-37.2 GHz +7 dBm, 37.2-40.0 GHz
<b>Minimum Settable Power:</b>	-5 dBm	-5 dBm	-5 dBm	-5 dBm
<b>Power Level Accuracy<sup>2</sup></b> (25°C±5°C)	±2.00 dB	±2.00 dB	±2.00 dB	±2.00 dB
<b>Power Flatness</b> (at max leveled power)	±1.50 dB	±1.50 dB <sup>3</sup>	±1.50 dB <sup>3</sup>	±1.50 dB <sup>3</sup>
<b>Source Output SWR</b>	<2.0	<2.0	<2.0	<2.0
<b>Spurious Signals</b> Harmonically related spurious:				
26.5 to 26.7 GHz	<-25 dBc	<-25 dBc	<-25 dBc	<-25 dBc
26.7 to 40.0 GHz	<-50 dBc	<-20 dBc <sup>4</sup>	<-20 dBc <sup>5</sup>	<-20 dBc <sup>5</sup>

# SWEEP OSCILLATORS

## HP 83550 Series Millimeter-Wave Source Modules (cont'd)

### HP 83555A, 83556A, 83557A, and 83558A

#### HP 83555A Output Characteristics<sup>1</sup>

	HP 8350B/83550A	HP 8350B/ 83590 Series/8349B	HP 8340B/8349B, HP 8341B/8349B	HP 8673B/C/D/8349B
<b>Maximum Leveled Power</b> (25°C±5°C)	+3 dBm	+3 dBm	+3 dBm	+3 dBm
<b>Minimum Settable Power:</b>	-5 dBm	-5 dBm	-5 dBm	-5 dBm
<b>Power Level Accuracy<sup>2</sup></b> (25°C±5°C)	±2.00 dB	±2.00 dB	±2.00 dB	±2.00 dB
<b>Power Flatness</b> (at max leveled power)	±1.50 dB	±1.50 dB <sup>3</sup>	±1.50 dB <sup>3</sup>	±1.50 dB <sup>3</sup>
<b>Source Output SWR</b>	<2.0	<2.0	<2.0	<2.0
<b>Spurious Signals</b> Harmonically related spurious:				
33.0 to 37.5 GHz	<-20 dBc	<-20 dBc	<-20 dBc	<-20 dBc
37.5 to 49.5 GHz	<-50 dBc	<-20 dBc <sup>4</sup>	<-20 dBc <sup>5</sup>	<-20 dBc <sup>6</sup>
49.5 to 50.0 GHz	<-20 dBc	<-20 dBc	<-20 dBc	<-20 dBc

#### HP 83556A Output Characteristics<sup>1</sup>

	HP 8350B/83550A	HP 8350B/ 83590 Series/8349B	HP 8340B/8349B, HP 8341B/8349B	HP 8673B/C/D/8349B
<b>Maximum Leveled Power</b> (25°C±5°C)	+3 dBm	+3 dBm	+3 dBm	+3 dBm
<b>Minimum Settable Power:</b>	-5 dBm	-5 dBm	-5 dBm	-5 dBm
<b>Power Level Accuracy<sup>2</sup></b> (25°C±5°C)	±2.25 dB	±2.25 dB	±2.25 dB	±2.25 dB
<b>Power Flatness</b> (at max leveled power)	±1.75 dB	±1.75 dB <sup>3</sup>	±1.75 dB <sup>3</sup>	±1.75 dB <sup>3</sup>
<b>Source Output SWR</b>	<2.0	<2.0	<2.0	<2.0
<b>Spurious Signals<sup>7</sup></b> Harmonically related spurious:				
40.0 to 45.0 GHz	<-20 dBc	<-20 dBc	<-20 dBc	<-20 dBc
45.0 to 60.0 GHz	<-50 dBc	<-20 dBc <sup>4</sup>	<-20 dBc <sup>5</sup>	<-20 dBc <sup>6</sup>

#### HP 83557A Output Characteristics

	HP 83623A or 83624A	HP 8341 opt 003/8349B	HP 8673 C/D/8349B	HP 8350B/83550A or HP 8350B/83592C/95C/ 8349B
<b>Maximum Leveled Power</b> (25°C±5°C)	+3 dBm	+3 dBm	+3 dBm	+3 dBm
<b>Minimum Settable Power:</b>	-2 dBm	-2 dBm	-2 dBm	-2 dBm
<b>Power Level Accuracy</b> (25°C±5°C)	±2.0 dB	±2.5 dB	±2.5 dB	±2.5 dB
<b>Power Flatness</b> (at max leveled power)	±1.5 dB	±2.0 dB	±2.0 dB	±2.0 dB
<b>Source Output SNR</b>				
Leveled:	<2.0	<2.0	<2.0	<2.0
Unleveled:	<3.0	<3.0	<3.0	<3.0
<b>Spurious Signals<sup>7</sup></b> Harmonically related spurious:	<-20 dBc	<-20 dBc	<-20 dBc	<-20 dBc

#### HP 83558A Output Characteristics

	HP 83623A or 83624A	HP 8341 opt 003/8349B	HP 8673 C/D/8349B	HP 8350B/83550A or HP 8350B/83592C/95C/ 8349B
<b>Maximum Leveled Power</b> (25°C±5°C)	0 dBm	0 dBm	0 dBm	0 dBm
<b>Minimum Settable Power</b>	-5 dBm	-5 dBm	-5 dBm	-5 dBm
<b>Power level accuracy</b> (25°C±5°C)	±2.0 dB	±2.5 dB	±2.5 dB	±2.5 dB
<b>Power flatness</b> (at max leveled power)	±1.5 dB	±2.0 dB	±2.0 dB	±2.0 dB
<b>Source Output SNR</b>				
Leveled:	<2.0	<2.0	<2.0	<2.0
Unleveled:	<3.0	<3.0	<3.0	<3.0
<b>Spurious Signals<sup>7</sup></b> Harmonically related spurious:	<-20 dBc	<-20 dBc	<-20 dBc	<-20 dBc

<sup>1</sup>All specifications apply to internally leveled operation only.

<sup>2</sup>Specified with respect to HP 83550A or HP 8349B power display. Includes power level flatness.

<sup>3</sup>Must have 0.5 V/GHz modification on microwave source.

<sup>4</sup>Except for the HP 83592C which is -45 dBc.

<sup>5</sup>Except for the HP 8341B Option 003 which is -40 dBc.

<sup>6</sup>Except for the HP 8673C/D which are -50 dBc.

<sup>7</sup>Expressed in dB relative to the carrier level (dBc).

### General Specifications

#### Waveguide Output Connector

HP 83554A: EIA size WR 28 waveguide; JAN UG-599 flange.

HP 83555A: EIA size WR 22 waveguide; JAN UG-383 flange.

HP 83556A: EIA size WR 19 waveguide; JAN UG-383 (mod.) flange.

HP 83557A: EIA Size WR 15 waveguide; JAN UG-385 flange.

HP 83558A: EIA Size WR 10 waveguide; JAN UG-387 flange.

**Weight:** Net, 1.7 kg (4 lb).

**Dimensions:** Module, 80 mm W x 80 mm H x 210 mm D (3.15" x 3.15" x 8.27")

**Furnished with Each Source Module:** Operating and Service Manual, Modification Procedures for 0.5 V/GHz output, Type-N RF Cable, Module Base Assembly, Synthesizer Interface Cable.

### Ordering Information

HP 83554A 26.5-40.0 GHz mm-Wave Source Module	\$9,500
HP 83555A 33.0-50.0 GHz mm-Wave Source Module	\$9,500
HP 83556A 40.0-60.0 GHz mm-Wave Source Module	\$9,500
HP 83557A 50.0-75.0 GHz mm-Wave Source Module	\$15,000
HP 83558A 75.0-110.0 GHz mm-Wave Source Module	\$15,000
Opt 910 Extra Manual	+\$40
Opt W30 Extended repair service see pg 723	
HP 83554/5/6	+\$225
HP 83557/8	+\$375
Opt W32 Calibration Service see pg 723	
HP 83554/5/6	+\$1,375
HP 83557/8	+\$1,360

# SWEEP OSCILLATORS

Model 8350 Series: RF Plug-Ins

HP 86200 Series

423

HP 86200 Series Plug-Ins: Specifications Summary	Broadband		Straddle-Band					Single-Band						
	HP 86222B <sup>1</sup>	HP 86290B <sup>2</sup>	HP 86240A	HP 86240B	HP 86240C	HP 86251A	HP 86235A	HP 86241A	HP 86242D	HP 86245A	HP 86250D	HP 86260B	HP 86260A	HP 86260C
<b>Frequency Characteristics</b>														
Range (GHz)	0.01-2.4	2.0-18.6	2.0-8.4	2.0-8.4	3.6-8.6	7.5-18.6	1.7-4.3	3.2-6.5	5.9-9.0	5.9-12.4	8.0-12.4	10.0-15.5	12.4-18.0	17.0-22.0
Accuracy (MHz, 25°C)														
CW Mode	±10	±20	±25	±25	±25	±20	±20	±30	±35	±40	±40	±50	±50	±50
Remote Programming, typical	±6	±2.5	±3.5	±3.5	±3.5	±20	±3.5	±25	±5.0	±20	±20	±25	±25	±25
All Sweep Modes (sweep time >100 ms)	±15	±80	±40	±50	±35	±60	±30	±33	±40	±50	±50	±70	±70	±70
<b>Residual FM</b> (kHz peak, 10 Hz-10 kHz bandwidth)	<5	<30	<9	<9	<9	<30	<7	<7	<15	<15	<15	<25	<25	<25
<b>Output Characteristics</b>														
Maximum Leveled Power (mW, 25°C)	>20	>10	>40	>20	>40	>10	>40	>5	>10	>50	>10	>10	>10	>10
Power Variation (dB, at max specified power)														
Internally Leveled	±0.33	±0.9	±1	±0.5	±0.8	±0.8	±0.8	±0.8	±0.5	±0.6	±0.5	±0.7	±0.7	±0.7
Externally Leveled (excluding coupler and detector variations)	±0.1	±0.15	±0.1	±0.1	±0.1	±0.15	±0.1	±0.1	±0.1	±0.1	±0.1	±0.1	±0.1	±0.1
Spurious Signals (dBc, at max specified power)														
Harmonically Related	<-25	<-25	<-16	<-45	<-16	<-35	<-20	<-16	<-40	<-17	<-40	<-25	<-25	<-25
Non-harmonics	<-25	<-50	<-60	<-60	<-60	<-50	<-60	<-60	<-60	<-60	<-60	<-50	<-50	<-50
Source SWR (50 ohms nominal, internally leveled)	<1.5	<1.9	<1.6	<1.6	<1.6	<1.9	<1.6	<1.6	<1.6	<1.6	<1.6	<2.0	<2.0	<2.0
<b>Modulation Characteristics</b>														
<b>External Pulse</b>														
Rise/Fall Time, typical (ns)	n/a	n/a	20	20	20	n/a	20	n/a	n/a	n/a	n/a	n/a	n/a	n/a
On/Off Ratio (dB)			40	40	40		40							
For Input (volts)			+6	+6	+6		+6							
<b>External FM<sup>3</sup></b>														
Maximum Deviation (MHz)														
DC to 100 Hz Rates	±75	±75	±75	±75	MLA <sup>3</sup>	±75	±75	±25	±150	±150	±150			
100 Hz to 1 MHz Rates	±5	±5	±5	±5		±5	±5	±2	±5	±5	±5			
1 MHz to 2MHz Rates	±2	±5	±2	±2		±5	±2		±5	±5	±5			
DC to 200 Hz Rates														
200 Hz to 200 kHz Rates												±75	±75	±75
Sensitivity, nominal (MHz/volt)	-20/-6	-20/-6	-20/-6	-20/-6	-20/-6	-20/-6	-20/-6	-6	-20/-6	-20/-6	-20/-6	-20/-6	-20/-6	-20/-6
<b>External AM</b>														
Linear Mode														
Frequency Response, Typical (kHz)	150	300	125	125	125	100	125	30	30	30	30	500	500	300
Attenuation (dB), typical, For Input (volts)	>30 +6	>30 +5	>30 +5	>30 +5	>30 +5	>30 +5	>30 +5	>25 -10	>20 +6	>20 +6	>20 +6	>25 -10	>25 -10	>25 -10
Square Wave Mode														
On/Off Ratio (dB), For Input (volts)	n/a	>30 +5	n/a	n/a	n/a	n/a	n/a	n/a	>40 +1	>40 +1	>40 +1	n/a	n/a	n/a
Compatible with HP 8757/8756 Mod Drive signal	Yes	Yes	Yes	Yes	Yes	Yes	Yes	No	Yes	Yes	Yes	No	No	No
<b>Internal AM</b>														
1 kHz Square Wave On/Off Ratio (dB)	>30	>25	>40	>40	>40	>25	>40	>25	>40	>40	>40	>25	>25	>25
<b>Prices</b>														
Plug-in	\$7,350 (86222A: \$6,350)	\$16,000 (86290C: \$20,000)	\$6,950	\$8,200	\$7,700	\$13,000	\$6,450	\$5,800	\$6,800	\$8,400	\$6,800	\$8,100	\$7,900	\$10,350
With Opt 002 (70 dB Attenuator)	+ \$750	n/a	+ \$905	+ \$905	+ \$905	n/a	+ \$850	n/a	n/a	n/a	n/a	n/a	n/a	n/a
With Opt 004 (Rear Panel RF Output)	+ \$200	+ \$200	+ \$200	+ \$200	+ \$200	+ \$200	+ \$200	+ \$200	+ \$200	+ \$200	+ \$200	+ \$200	+ \$200	+ \$200
With Opt. H80 or O08 (MLA Upconverter)	+ \$1505	n/a	n/a	n/a	standard	n/a	+ \$1005	+ \$1505	+ \$1005	+ \$1005	+ \$1005	n/a	+ \$1505	n/a
With W30 extended repair service	+\$180(B)	+\$390(b)	+\$170	+\$200	+\$195	+\$285	+\$155	+\$140	+\$165	+\$205	+\$160	+\$190	+\$190	+\$250
Return to HP Support	+\$155(A)	+\$500(C)												
With W32 Calibration	+\$1010(B)	+\$905(B)	+\$820	+\$950	+\$840	+\$470	+\$820	+\$725	+\$940	+\$800	+\$760	+\$530	+\$760	+\$530
Service See page 723	+\$1060(A)	+\$1060(C)												

<sup>1</sup>HP 86222A specifications identical to HP 86222B, except that the HP 86222B has 1, 10, and 50 MHz crystal markers which allow enhancement of frequency accuracy to better than ±200 kHz.

<sup>2</sup>HP 86290C specifications identical to HP 86290B, except that the HP 86290C has maximum leveled power >20 mW. HP 86290B specifications listed apply to frequencies 6 to 12.4 GHz.

<sup>3</sup>The HP 86240C has Microwave Link Analyzer (MLA) compatibility as a standard feature.

# AMPLIFIERS

## RF Amplifier HP 8347A

- Broadband 100 kHz to 3 GHz coverage
- +20 dBm output power
- Low harmonics
- 25 dB gain
- Internally leveled

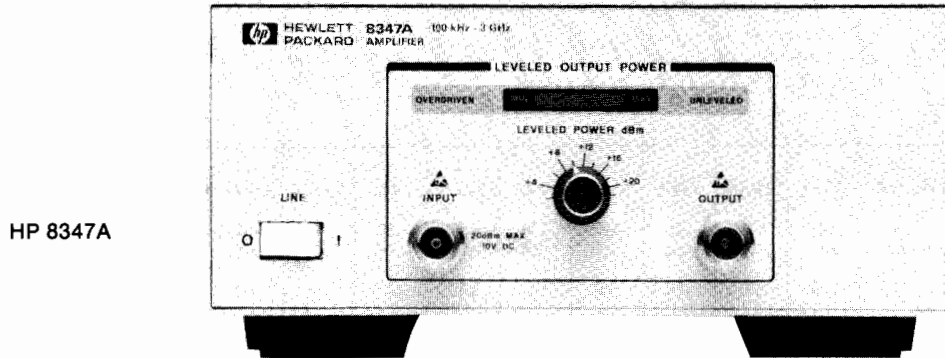

HP 8347A

The HP 8347A is a general-purpose broadband instrumentation amplifier capable of providing gain and power to overcome systematic RF losses, drive high-power devices, or improve measurement system performance.

Switching and signal routing in ATE systems, frequency conversion, and long transmission paths to remote devices like antennas on towers are examples of systematic power losses. With more than 25 dB of gain, the HP 8347A can overcome such losses, and its internal leveling loop can reduce mismatch and reflection effects in a system.

Many devices, like mixers, power amplifiers, and optical modulators, require high-power drive signals. These devices are often very level-sensitive as well. The flat, leveled, +20 dBm output power of the HP 8347A allows proper device operation or complete characterization.

EMI, surveillance, and other demanding small-signal measurements sometimes stretch the capabilities of even the best test equipment. The HP 8347A can be used as a preamplifier to increase sensitivity in spectrum analysis and frequency counting applications, and can also extend dynamic range and increase low-level sweep speed in network analysis.

### Improve HP 8753 Dynamic Range or Sweep Time

Using the illustrated configuration, the HP 8753 RF network analyzer dynamic range can be improved from 100 to 120 dB, or alternatively, sweep time increased by almost 100 times.

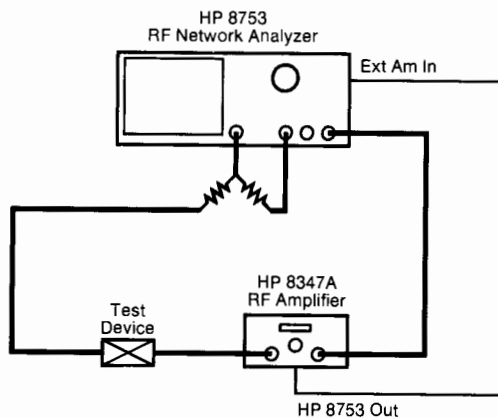

Extended Dynamic Range Configuration

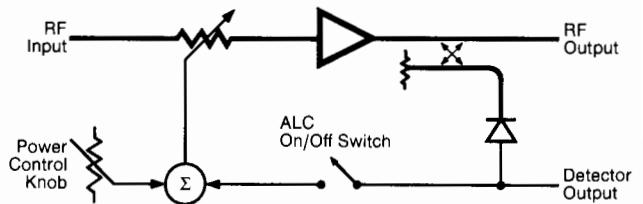

Simplified Block Diagram

### Specifications

**Frequency Range:** 100 kHz to 3 GHz

**Maximum Leveled Output Power:**  $\geq +20$  dBm

**Output Power Leveling Range ( $\geq 300$  kHz):** +2 to +20 dBm

**Power Flatness (internally-leveled,  $\pm 300$  kHz):**  $\pm 1.5$  dB

**Gain:**  $\geq 25$  dB

**Harmonics (at +20 dBm output)**

**Internal Leveling Off (ALC Off):**  $\leq -25$  dBc

**Internal Leveling On (ALC On):**  $\leq -20$  dBc

### Supplemental Characteristics

**Maximum Input for Minimum Internally-Leveled**

**Output:** -14 dBm

**1 dB Compression Point:** +22 dBm

**Third-Order Intercept:** +30 dBm

**RF Input and Output Impedances:** 50 ohms

**VSWR**

**Input:** 2.0:1

**Output**

**Internally-Leveled:** 1.5:1

**Unleveled**

Below 2 GHz: 2.0:1

2 to 3 GHz: 3.0:1

**Reverse Isolation:** 60 dB

**Noise Figure**

**10 MHz to 3 GHz:** 15 dB

**Below 10 MHz:** 20 dB

### General

**RF Input and Output Connectors:** Type N female.

**Dimensions:** 102 H X 213 W X 298 mm D (4.0" X 8.4" X 11.8").

**Weight:** Net 4 kg (8 lb). Shipping 5 kg (11 lb).

### Ordering Information

HP 8347A RF Amplifier

**Price**

\$4,150



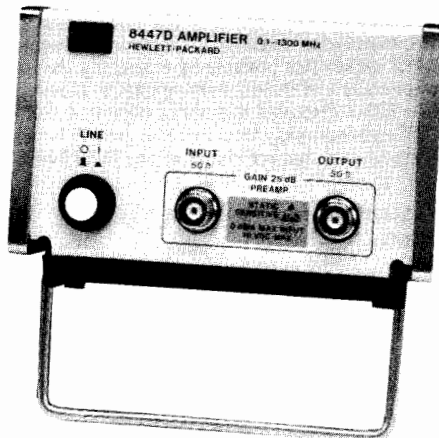
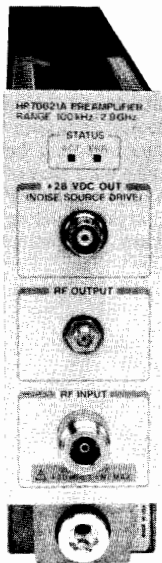

HP 70621A and HP 8447D

### HP 8447 Series Amplifiers

These low-noise, high-gain amplifiers improve the sensitivity of counters, spectrum analyzers, RF voltmeters, EMI meters, power meters, and other devices. They will also increase the maximum power available from a signal generator or sweeper.

#### Options

- Standard connectors are BNC (f) on all amplifiers.
- Option 010 — single-channel amplifier, N (f) connectors
- Option 001 — dual-channel amplifier, BNC (f) connectors
- Option 011 — dual-channel amplifier, N (f) connectors

### Specifications

	HP 8447A Preamp	HP 8447D Preamp	HP 8447E Power Amp	HP 8447F Preamp-Power Amp	HP 70621A Preamp
Frequency Range	0.1–400 MHz	100 kHz–1.3 GHz	100 kHz–1.3 GHz	100 kHz–1.3 GHz	100 kHz–2.9 GHz
Typical 3 dB Bandwidth	50 kHz–700 MHz	75 kHz–1.7 GHz	75 kHz–1.4 GHz	50 kHz–1.4 GHz	50 kHz–3.3 GHz
Gain (Mean, per channel)	20 dB ± 1.0 dB at 10 MHz (20°C–30°C) 20 dB ± 1.7 dB at 10 MHz (0°C–55°C)	>25 dB (20°C–30°C)	22 dB ± 1.5 dB (20°C–30°C)		>24 dB (characteristic)
Gain Flatness Across Full Frequency Range	±1.8 dB (0°C–55°C) ±0.7 dB (20°–30°C) Characteristic	±1.5 dB	±1.5 dB		+1.2 dB (+0.8 dB bypass)
Noise Figure	<7 dB	<8.5 dB	<11 dB typical		<6 dB (characteristic)
Output Power for 1 dB Gain Compression	>+6 dBm	>+7 dBm typical	>+12.5 dBm 100 MHz - 1 GHz		>0 dBm (characteristic)
Harmonic Distortion	-32 dB for 0 dBm output	-30 dB for 0 dBm output (typical)	-30 dB for +8 dBm output		-30 dB for 0 dBm output (characteristic)
Output for <-60 dB Harmonic Distortion	-25 dBm (Characteristic)	-30 dBm	-20 dBm		-30 dBm (characteristic)
VSWR	<1.7	<2.0 input <2.2 output 1–1300 MHz	<2.2 input <2.5 output 1–1300 MHz		2.0 input (1.3 bypass) 1.9 output (1.3 bypass)
Reverse Isolation	>30 dB	>40 dB	>40 dB		>50 dB
Maximum DC Voltage Input	±10 V	±10 V	±10 V		+20 V
Options Available	001	001, 010, 011	010	010	
Option Prices	+\$630	+\$690, \$102, \$1,050	+\$110	+\$395	

↑ HP 8447D AND 8447E COMBINED IN A SINGLE PACKAGE ↓

Dual-channel, 50-ohm (nominal) amplifiers are ideal for dual-channel systems such as oscilloscopes or network analyzers. Channels may also be cascaded for increased small-signal gain.

#### General Specifications

**Weight:** net, 1.56 kg (3.4 lb); shipping, 2.30 kg (5.1 lb)  
**Size:** 85.8 H x 130 W x 216 mm D (3.4" x 5.1" x 8.5")  
**Power requirements:** 110 or 230 V ac ± 10%, 48–440 Hz, 15 watts

#### HP 70621A Pre-amplifier

This new low-noise, high-gain preamplifier for the HP 70000 modular measurement system has the same high-performance capabilities of a standalone model. It adds automatic calibration of the spectrum analyzer display, correcting for preamplifier gain and flatness. And it adds switches to bypass the preamp, so you use the same input port to measure high-and low-level signals.

#### General Specifications

**Displayed average noise level (with HP 71100C spectrum analyzer)**

Band	With preamp	Preamp bypassed
10 MHz - 2.0 GHz	-156 dBm	-133 dBm
2.0 - 2.9 GHz	-156 dBm	-130 dBm

#### Bypass insertion loss

0 Hz - 2.9 GHz <1 dB (characteristic)  
 0 Hz - 26.5 GHz <6 dB (characteristic)

**RF input:** type-N (f), 50-ohm (nominal)

**RF output:** SMA (f), 50-ohm (nominal)

**Excess noise source drive:** +28 VDC out (used to drive HP 346A/B/C excess noise source), BNC (f)

**Calibration cycle:** 3 years (recommended)

**Weight:** net, 1.8 kg (4 lb)

#### Ordering Information

Part Number	Price
HP 8447A preamplifier	\$1,440
HP 8447D preamplifier	\$1,540
HP 8447E power amplifier	\$1,740
HP 8447F preamplifier-power amplifier	\$2,610
HP 70621A preamplifier module	\$4,900

Opt 098 HP 70900A controller board upgrade kit for ROM versions 850730 or 860203

Opt 099 firmware upgrade kit for ROM versions between 861015 and 900314

☎ For same-day shipment, call HP DIRECT at 800-538-8787.

# AMPLIFIERS

## Microwave Amplifier

### HP 8349B

- Continuous 2 to 20 GHz coverage
- 15 dB gain to 18.6 GHz



HP 8349B

The HP 8349B Microwave Amplifier delivers increased microwave power performance across a 2 to 20 GHz frequency range. This general-purpose broadband power amplifier is designed for maximum reliability and configured for the greatest convenience in interfacing with Hewlett-Packard's microwave sources, the HP 8350B Sweep Oscillator, HP 8340B/8341B/8360 Series Synthesized Sweepers, and HP 8671B, 8672A, or 8673 series Synthesized Signal Generators.

Providing 100 mW (+20 dBm) of unlevelled output power from 2 to 18.6 GHz, 63 mW (+18 dBm) from 18.6 to 20 GHz, the HP 8349B offers one of the broadest operating bandwidths available from a solid-state power amplifier. This performance is achieved using a multiple stage GaAs FET design, resulting in >15 dB of gain from 2 to 18.6 GHz, and >12 dB of gain from 18.6 to 20 GHz.

The HP 8349B can also provide externally-leveled output power without using an external coupler and detector, since these components are built-in and are compatible with Hewlett-Packard microwave sources. The HP 8349B is also equipped with an output power display, minimizing the need for an external power meter and enhancing the amplifier's utility. For example, the HP 8349B can be placed at the end of a long RF cable where the microwave output needs to be amplified, leveled and monitored.

Naturally, the versatile power control features of the microwave source (e.g., calibrated power, power sweep, power slope and remote power control via the Hewlett-Packard Interface Bus) can be accurately transmitted through the HP 8349B during external leveling operations.

The HP 8349B also has a built-in source module interface, enabling it to properly bias and control the HP 83550 series millimeter-wave source modules. Using the HP 8349B and a millimeter source module extends the capabilities of any 11 to 20 GHz HP microwave source to millimeter-wave frequencies.

### Applications

The broadband high power of the HP 8349B is ideal, whether in a versatile bench-top arrangement or a dedicated rack-mount system. In antenna testing, the HP 8349B can be placed at the end of long RF cables, delivering high power right to the device under test. In EW/ECM systems, the HP 8349B can be combined with the HP 8340B/8341B/8360 Series, or the HP 8673 series Synthesized Signal Generators to provide high power pulses with little degradation in pulse performance. The HP 8349B is also an excellent choice as a microwave driver for TWTs, high power amplifiers, or mixers. And with a typical noise figure <13 dB, the HP 8349B is often used as a pre-amplifier for spectrum analyzers and frequency counters.

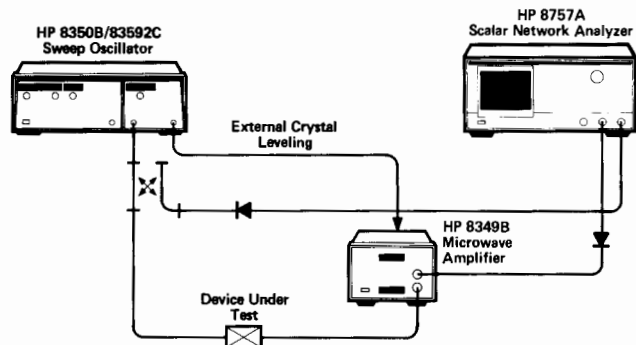

Extended Dynamic Range Configuration

- 100 milliwatts across 2 to 18.6 GHz
- <13 dB typical noise figure

The dynamic range of a scalar network analyzer measurement system is limited by the maximum output power of the microwave source and the sensitivity of the detectors. Using the illustrated configuration, up to 100 dB of dynamic range can be achieved by combining the calibrated dynamic range of the reference detector (R) with that of the transmission detector (B) in a ratio measurement (B/R). The HP 8349B makes this possible by extending the external crystal leveling power control of the microwave source. Hewlett-Packard Application Note 327-1 discusses this application in detail.

RFI susceptibility tests can also greatly benefit from the high quality amplifying characteristics of the HP 8349B.

### Frequency Specifications

Range: 2-20 GHz

### Output and Input Specifications (25°C ±5°C)

Minimum Output Power (at +5dBm input):

Frequency Range (GHz)	Output	
	Leveled	Unleveled
2.0 to 18.6	19 dBm (80mW)	20 dBm (100mW)
18.6 to 20.0	17 dBm (50mW)	18 dBm (63mW)

**1 dB Compression Point:** +21 dBm, nominal

**Power Flatness (Leveled):** ±1.25 dB

**Minimum Small Signal Gain (at -5 dBm input):**

2.0 to 18.6 GHz: 15dB

18.6 to 20.0 GHz: 13dB

**Noise Figure:** <13 dB, typical

**Impedance (Input and Output):** 50 ohms, nominal

**VSWR:**

Frequency Range (GHz)	Input	Output	
		Leveled	Unleveled (typical)
2.0 to 5.0	≤2.8	≤2.5	≤4.8
5.0 to 11.0	≤2.8	≤2.5	≤3.8
11.0 to 18.0	≤2.8	≤2.5	≤3.2
18.0 to 20.0*	≤2.8	≤2.5	≤3.2

\*VSWR from 18.0 to 20.0 GHz is typical

**Maximum Continuous Input, to the input or output ports:**

+27 dBm (RF), ±10V (DC)

### Spectral Purity

**Harmonics (at +20 dBm output):**

2.0 to 11.0 GHz: <-20 dBc

11.0 to 20.0 GHz: <-30 dBc typical

**Non-Harmonic Spurious:** ≤-55 dBc.

**Third Order Intercept:** +33 dBm, nominal.

### Pulse Transmission Capability

**Rise/Fall Time:** <10 ns typical

### General

**Reverse Isolation:** >50 dB, typical

**RF Input/Output Connectors:** Type N Female

**Size:** 133 H x 214 W x 366 mm D (5.2" x 8.36" x 13.6").

**Weight:** Net, 7 kg (15 lb); shipping, 14 kg (31 lb).

### Ordering Information

HP 8349B 2 to 20 GHz Microwave Amplifier

Opt 001 Rear Panel RF Input/Output

Opt 002 Rear Panel RF Input with Front Panel RF Output

Opt W30 Extended repair service. See page 723

☎ For same day shipment, call HP Direct at 800-538-8787

**Price**

\$8,100 ☎

+ \$100

+ \$100

+ \$165

- 1 to 26.5 GHz frequency range
- 28 dB gain
- 10 dB noise figure

- Measure extremely low-level signals
- $< -150$  dBm sensitivity at 22 GHz
- Improve measurement speed



HP 70620B  
and HP 8449B

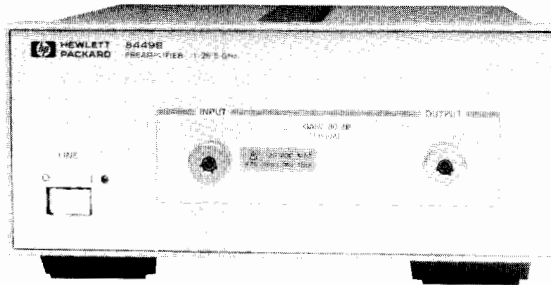
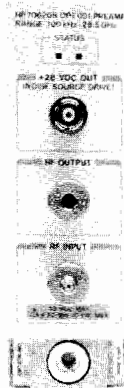

### HP 8449B Preamplifier

This 1 to 26.5 GHz high-gain, low-noise preamplifier increases the sensitivity of any microwave spectrum analyzer, enabling you to detect and analyze very low-level signals in dramatically reduced measurement time. The improved sensitivity lets you widen bandwidths and measure low-level signals using much shorter sweep times.

#### Specifications

**Frequency range:** 1.0-26.5 GHz

**Maximum safe input power:** +20 dBm

**Maximum dc input:** +20 Vdc

**Gain compression:**  $< 1$  dB for signals  $\leq +7$  dBm at the output (characteristic)

**Gain:**  $> 26$  dB (20-30° C); 30 dB (20-30° C);  $> 23$  dB (0-55° C)

Noise figure:	Band	Specified	Typical
	1.0-12.7 GHz	$< 8.5$ dB	7 dB
	12.7-22.0 GHz	$< 12.5$ dB	9 dB
	22.0-26.5 GHz	$< 14.5$	12 dB

**Third-order intercept:** +15 dBm at the output (characteristic)

**Second harmonic intercept:** +30 dBm at the output (characteristic)

Frequency response:	Band	Variation
	1.0-26.5 GHz	+4.5 dB (0-55° C)
	2.0-22.0 GHz	+2.4 dB (20-30° C, typical)

**Amplitude temperature drift:**  $\leq -0.12$  dB/° C (characteristic)

**Displayed average noise level, 0db attn, 10 Hz res BW (characteristic)**

With the HP 8563A		With the HP 8566B	
Band		Band	
1.0-2.9 GHz	-153 dBm	1.0-2.5 GHz	-155 dBm
2.75-6.46 GHz	-154 dBm	2.0-5.8 GHz	-154 dBm
5.86-13.0 GHz	-146 dBm	5.8-12.5 GHz	-150 dBm
12.4-19.7 GHz	-141 dBm	12.5-18.6 GHz	-144 dBm
19.1-22/26.5 GHz	-136 dBm	18.6-22.0 GHz	-140 dBm

**RF input/output:** APC-3.5 (m), 50-ohm (nominal)

Input VSWR:	Band	
	1.0-2.0 GHz	2.0:1
	2.0-12.5 GHz	1.5:1
	12.5-26.5	2.0:1

**Output VSWR:** 1.0-26.5 GHz 2.0:1

**Reverse isolation:**  $> 75$  dB

**Temperature:** operation, 0° to +55° C; storage, -40° to +75° C

**EMI:** FTZ 1046; CISPR Pub 11; MIL-STD 461C, part 7, CE03 and RE02

**Power requirements:** 100, 120, 220, or 240 volts (+10%), 47-63 Hz

**Calibration cycle:** 3 years (recommended)

**Weight:** net, 4 kg (8.8 lb) nominal

**Size:** 102 H x 213 W x 297 mm D (4" x 8.4" x 11.74")

### HP 70620B Preamplifier

This new high-performance module for the HP 70000 modular measurement system has all the features and benefits of a standalone model. It also sends gain and flatness calibration data directly to an HP 70000 series spectrum analyzer. Bypass mode allows you to view high-and low-level signals. Extend performance to 100 kHz with option 001.

#### Specifications

**Frequency range:** 1.0-26.5 GHz; 100 kHz-26.5 GHz (opt 001)

**Maximum safe input power:** +20 dBm

**Maximum dc input:** +20 V; +10 V (opt 001)

**Gain compression:**  $< 1$  dB for signals  $\leq +7$  at preamp output (characteristic)

**Displayed average noise level (0 dB input atten, 10 Hz res BW) with the HP 71210C**

Band	With preamp	Preamp bypassed
1.0-2.9 GHz	-155 dBm	-138 dBm
2.7-12.8 GHz	-153 dBm	-132 dBm
12.6-22.0 GHz	-150 dBm	-130 dBm

**Bypass insertion loss, characteristic:** 0 Hz-2.9 GHz,  $< 1.0$ ; 2.7-12.7 GHz,  $< 1.8$ ; 12.7-26.5 GHz,  $< 2.5$

**Third-order intercept:** +15 dBm at preamp output (characteristic)

**Second harmonic intercept:** +30 dBm at preamp output (characteristic)

**Amplitude temperature drift:** 1-26.5 GHz  $\leq -0.12$  dB/°C (characteristic)

**RF input/output:** APC-3.5 (m), 50-ohm (nominal)

Input VSWR:	Band	With preamp	Preamp bypassed
	1.0-2.7 GHz	2.2:1	1.3:1
	2.7-12.7 GHz	1.6:1	1.7:1
	12.7-26.5 GHz	2.8:1	2.4:1

Output VSWR:	Band	With preamp	Preamp bypassed
	1.0-2.7 GHz	2.0:1	1.3:1
	2.7-12.7 GHz	2.0:1	1.5:1
	12.7-26.5 GHz	2.2:1	2.2:1

**Excess noise source drive:** +28 VDC out (used to drive HP 346A/B/C excess noise source BNC (f))

**Reverse isolation:**  $> 75$  dB

**Calibration cycle:** 3 years (recommended)

**Weight:** net, 1.8 kg (4 lb) nominal

#### Ordering Information

Part Number	Description	Price
HP 8449B	1-26.5 GHz preamplifier	\$7,000
Opt 907	front handle kit	+\$65
Opt 908	rack mount kit (half rack width)	+\$50
HP 70620B	1-26.6 GHz preamplifier module	\$8,000
Opt 001	100 kHz-26.5 GHz	\$4,500
Opt 098	HP 70900A controller board upgrade kit for ROM versions 850730 or 860203	\$0
Opt 099	firmware upgrade kit for ROM versions between 861015 and 900314	\$0

# FUNCTION GENERATORS & WAVEFORM SYNTHESIZERS

## General Information

### Introduction

Hewlett-Packard offers a wide variety of signal sources for almost any application, including function generators, and frequency or waveform synthesizers. Output frequencies range from 1  $\mu$ Hz to 80 MHz.

For higher frequency applications, refer to the "Signal Generators" and "Sweep Oscillators" sections of this catalog.

### Standard

Standard function generators typically offer a variety of waveforms, such as sine-wave, square, triangle and ramp.

The HP 8111A offers, in addition, pulse capabilities and the HP 3312A has modulation and sweeping capabilities. Both generators can be used in manual operation only.

### Multi-Functional

Functionality describes function generators which are capable of more than generating a variety of waveforms. For example up to 150 vectors can be defined with the HP 3314A for the generation of arbitrary signals.

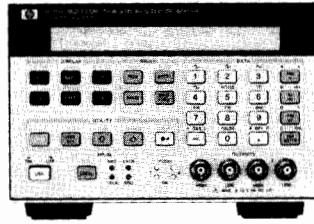

### Analog/Digital Arbitrary Waveforms

The HP 8175A Digital Signal Generator is a data generator, which provides, with the option 002, arbitrary signals on two analog channels. Digital pattern and analog signals can also be generated simultaneously.

### Synthesized Arbitrary Waveforms

The HP 8770A in conjunction with an HP 9000 series 300 Desktop Computer and the HP 11776A Waveform Generation Software is a complete system for the generation of most complex arbitrary waveforms with synthesizer accuracy. Waveforms can be created in both the time and frequency domain.

### Multifunction Synthesized Waveforms

The HP 8904A Multifunction Synthesizer digitally creates a multitude of complex

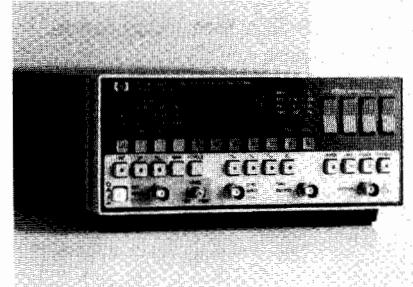

signals from six simple waveforms. It begins with a Synthesizer/Function generator offering standard waveforms, DC and noise. Option 001 adds three channels which can modulate the first synthesizer, option 002 adds a second independent synthesizer output. Modulation capabilities include AM, FM, PM, DSB and pulse.

### Fast

These instruments offer all of the standard waveforms over the full frequency range up to 50 MHz. The HP 8116A and HP 8165A combine these features with different modes, modulation and sweep capabilities. Both instruments can be used as pulse generators. The HP 8165A with its frequency stability of 1 ppm/day has synthesizer quality.

## HP Function Generators Summary I

HP Models	Standard		Multi-Functional				Fast		
	HP 8111A	HP 3312A	HP 3245A	HP 3314A	HP 8904A	HP 8175A	HP 8770A	HP 8116A	HP 8165A
Sine Wave Min. Frequency Max. Frequency	1Hz 20MHz	0.1Hz 13MHz	0Hz 1MHz	1mHz 20MHz	0Hz 600kHz	dc 25MHz	dc 50MHz	1mHz 50MHz	1mHz 50MHz
Waveforms Square Triangle Ramp Pulse Arbitrary	1Hz-20MHz 1Hz-20MHz 1Hz-20MHz 1Hz-20MHz	0.1Hz-13MHz 0.1Hz-13MHz 0.1Hz-13MHz	0Hz-1MHz 0Hz-1MHz 2048 points	1mHz-20MHz 1mHz-20MHz 150 vectors	0.1Hz-50kHz 0.1Hz-50kHz 0.1Hz-50kHz	Full Arbitrary Waveform	Full Arbitrary Waveform	1mHz-50MHz 1mHz-50MHz 1mHz-50MHz 1mHz-50MHz	1mHz-50MHz 1mHz-50MHz 1mHz-50MHz 1mHz-20MHz
Modes Trigger Gate Counted Burst	ext ext 1 to 1999	int/ext int/ext	int/ext int/ext int subroutine	int/ext int/ext 1 to 1999	Creates signals from six basic Waveforms	Full Arbitrary Waveform	Full Arbitrary Waveform	ext ext 1-1999	ext ext 1-1999
Modulation AM FM PM PWM		int/ext int/ext	int subroutine Arbitrary	ext ext	int int int	Full Arbitrary Waveform	Full Arbitrary ext HP 11776A	ext ext ext	ext ext
Sweep Lin. Log. VCO		int/ext int/ext	int int int sub routine	int int ext	int none int	Full Arbitrary Waveform	Full int/ext Waveform	ext int/ext ext	ext
Output (into 50 Ohms) Amplitude (p-p) dc Offset Output Impedance- $\Omega$	16V $\pm 8V$ 50	10V $\pm 4.5V$ 50	10V $\pm 5V$ 0150	10V $\pm 5V$ 50	10V $\pm 5V$ 50	16V $\pm 8V$ 50	2V 50	16V $\pm 8V$ 50	20V $\pm 10V$ 50/1000
Programmability			HP-IB	HP-IB	HP-IB	HP-IB	HP-IB	HP-IB	HP-IB
Notes			2 independent channels, also AC current and 6-digit precision DC voltage or current.	also 1/2 cycle bursts, phase lock	4 internal channels. One is modulated or sequenced	2 analog outputs dig./analog signals simultaneously	HP Series 300 Controller, plus HP 11776A Software recommended		
Catalog page	437	430	432	430	434	438	374	440	442

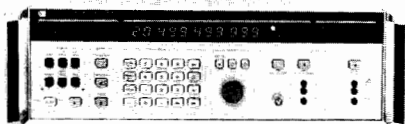

### Synthesizers

Synthesizers provide sinewaves with the focus on a very high frequency stability and excellent level accuracy. You can choose among different output impedances. The HP 3335A generates sinewaves up to 81 MHz and the HP 3336A/B/C has modulation capabilities.

### Synthesized Function Generators

Synthesized function generators combine the frequency stability of a synthesizer with the feature set of the function generator. The HP 3324A has good synthesizer performance and versatile sweep modes which are phase continuous over the full frequency range. In addition, the HP 3325B provides various modulation capabilities and excellent synthesizer performance. The HP 3326A plays a special part because of its two channels, which can be combined in various ways to produce two-tone signals or calibrated two-phase signals.

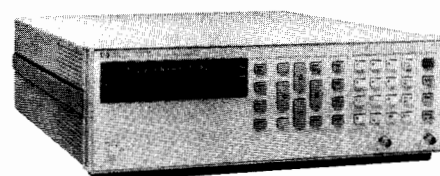

### Which function generator do you need?

HP's function generators and synthesizers are the best solution for most applications. The tables shown on these two pages will help you to determine the right one for your application. The instruments are split into categories, depending on their main specifications. For an explanation of the instrument's full range of capabilities, see the following information.

### HP Function Generators Summary II

HP Models	SYNTHESIZED FUNCTION GENERATORS			SYNTHESIZERS	
	3324A	3325B	3326A	3335A	3336A/B/C
Sinewave					
Min. Frequency	1mHz	1 $\mu$ Hz	DC	200Hz	10Hz
Max. Frequency	21MHz	21MHz	13MHz	81MHz	21MHz
Frequ. Stability	10 <sup>-7</sup> /month	10 <sup>-7</sup> /month	10 <sup>-7</sup> /month	10 <sup>-8</sup> /day	1.5x10 <sup>-8</sup> /day
Frequ. Resolution	1mHz	1 $\mu$ Hz	1 $\mu$ Hz	1mHz	1 $\mu$ Hz
Waveforms					
Square	1mHz-11MHz	1 $\mu$ Hz-11MHz	dc - 13MHz		
Triangle	1mHz-11kHz	1 $\mu$ Hz-11kHz			
Ramp	1mHz-11kHz	1 $\mu$ Hz-11kHz			
Pulse			dc - 13MHz		
Modulation					
AM		int/ext	int/ext		ext
FM					
PM		int/ext	int/ext		ext
PWM			ext		
Sweep					
Lin.	int	int	int	int	int
Log.	int	int			int
Discrete	int	int	int		
VCO					
Level Range - 50 $\Omega$	10V(p-p)	10V(p-p)	10V(p-p)	-87 to +13dBm	-71 to +8dBm
Level Resolution	4 digits	4 digits	4 digits	0.01 dB	0.001 dB
Level Accuracy	$\pm 0.9$ dB	$\pm 0.9$ dB	$\pm 1.0$ dB	$\pm 0.1$ dB	$\pm 0.08$ dB
DC Offset-50 $\Omega$	$\pm 5$ V	$\pm 5$ V	$\pm 5$ V		
Output impedance- $\Omega$	50	50	50	50/75/124/ 135	50/75/124/ 135/150/600
Spurious	-55 dBc	-70 dBc	-70 dBc	-75 dBc	-70 dBc
Phase noise	-50 dBc	-60 dBc	-66 dBc	-58 to -70 dBc	-64 dBc
Notes	60MHz TTL clock, multi-interval and multi-marker sweep	Modulation source can be used separately	2 channels, two-tone and two phase signals		
Catalog page	445 446	443 444	443 444	447	447

### Broad application range

If your applications involve a large variety of measurements then one of HP's standard function generators is the right solution.

### Simulating real life signals

HP's Arbitrary Function Generators are dedicated for the simulation of real-life signals. Ranging from disc drive or video test signals to mechanical vibration simulation. Applications such as VOR, FM stereo and communications signalling are covered by the Multifunction Synthesizer HP 8904A.

### Versatility and speed

Many applications require standard waveforms over the full frequency range up to 50 MHz and with versatile operating modes. These requirements can be fulfilled with the HP 8116A and HP 8165A. Especially for those applications requiring 50 MHz in conjunction with good frequency stability the HP 8165A can be recommended.

### Highly accurate reference sources

Applications such as PLL-testing, calibration of measurement instruments and testing of Frequency Division Multiplex equipment are ideally suited for HP's synthesizers. The very stable frequency source and the excellent level accuracy make these synthesizers the right choice if a reference source is required.

### Accuracy and versatility

Synthesized function generators are for those applications which require a combination of an accurate frequency source and a versatile function generator. Sweeping over the entire frequency range without any phase discontinuity makes these generators ideal for applications such as simulation of rotation signals and filter testing. Even the calibration of phase measuring instruments is possible by programming a certain phase offset between two generators or using the HP 3326A's two outputs.

# FUNCTION GENERATORS & WAVEFORM SYNTHESIZERS

## Function Generator

HP 3314A, 3312A

- Lin/Log sweeps, gate, counted burst, AM/FM/VCO
- Arbitrary waveform generator
- Phase lock xN and  $\div N$  modes, 1/2-cycle mode

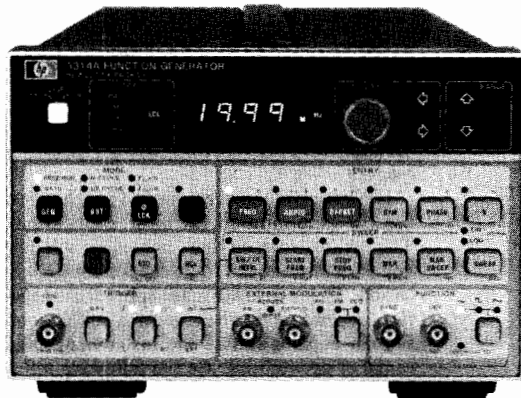

HP 3314A



### HP 3314A Multi-Waveform Generator

The HP 3314A Function/Waveform Generator has the precision and versatility to produce numerous waveforms. Its feature set includes accurate sine, square, and triangle waves, with ramps and pulses available using variable symmetry. Additional features include counted bursts, gate, lin/log sweeps, AM, FM/VCO, dc offset, and phase lock. For increased versatility, the arbitrary waveform mode allows a countless number of user-defined waveforms. Because complete programmability is provided, all of these capabilities are available for ATE systems, as well as bench applications.

### Precise Functions

The HP 3314A provides sine, square, and triangle waveforms from 0.001 Hz to 19.99 MHz with an amplitude range of 0.01 mV to 10 Vp-p into 50 ohms, with optional 30 Vp-p into > 500 ohms.

Continuous waveforms are provided with high accuracy and low distortion, with frequency accuracy on the upper range of 0.01% and sine distortion < -55 dBc to 50 kHz.

Pulses and ramps are provided to 2 MHz using the variable symmetry control over the full 5% to 95% symmetry range. This provides narrow pulses with 9 ns rise/fall times for digital circuit testing, and positive or negative ramps for amplifier testing and process control.

Independent dc offset to  $\pm 5$  V (into 50 ohms) can be added to any ac signal. A post-attenuator summing technique is used to provide large ac signals with small offsets and vice versa.

### Burst and Gate

The N cycle burst mode generates an integer number of complete cycles at each trigger. Bursts of 1 to 1999 cycles are possible for use in applications ranging from sonar testing to digital circuits. Variable symmetry and start/stop phase can be used to produce single ramps and haversines.

Like burst mode, gate mode can be triggered internally or externally. In gate, the HP 3314A output consists of complete cycles, pulses or arbitrary waveforms which start when the trigger is true, and stop after the trigger goes false. In gate and burst modes, the full frequency range applies for sine, square, triangle, pulse, and ramp waveforms.

### 1/2 Cycle and Integer Phase Lock Modes

The 1/2 cycle burst mode allows simulation of specialized signals found in electronics. At each trigger, alternating 1/2 cycles of sines or triangles are produced. With the addition of variable start/stop phase and symmetry, pulses with variable rise/fall time and overshoot can be produced. Repetition rate, 1/2 cycle frequency, symmetry, and phase can be set independently to produce a variety of waveforms.

The Fin X N and Fin  $\div$  N modes provide powerful phase locking capability. With integer phase lock, fractions or multiples of the ref-

erence signal can be provided, and  $\pm 200$  deg of phase offset is available. The HP 3314A phase locks to the plus or minus edge of the trigger signal; it can lock to a variety of signals such as sines, squares, pulses, ramps, and others, with complete control of output function, symmetry, N, phase, amplitude and offset.

### Modulation and Sweep

Complete AM, FM/VCO modulation give the HP 3314A versatile signal modifying capabilities. With 100 kHz bandwidths, AM and FM/VCO can be used separately or simultaneously to produce many waveforms.

Multi-frequency measurements can be made with HP 3314A sweep capabilities. Linear, logarithmic, and manual sweep make measurements of filters, amplifiers, and other networks convenient and accurate. X drive, marker, and trigger output signals are also provided.

### Arbitrary Waveforms

For specialized low frequency applications, you can use the HP 3314A arbitrary (ARB) waveform mode to create custom waveforms as a series of voltage ramps or vectors. Values are easy to enter from the front panel, using the modify knob as a pencil and an oscilloscope as a pad. For remote programming, use a desktop or mainframe computer to calculate the values, then program them using the HP-IB. Arbitrary waveforms are automatically stored in non-volatile memory for quick recall.

### Two Sources in One

A square-wave trigger source is included for generation of complex waveforms with a single HP 3314A. The 0.5 mHz to 500 kHz internal trigger is useful in gated, burst, and phase locked waveforms. This signal is provided as an output for synchronizing the HP 3314A to other devices.

### Specifications

#### Frequency

**Range:** 0.001 Hz to 19.99 MHz-sine, square and triangle waveforms, 0.001 Hz through 2 MHz range when symmetry  $\neq$  50%.

**Resolution:** 3 1/2 digits.

#### Accuracy

Autorange	Range Hold	Accuracy
0.001 Hz-19.99 Hz	0.001 Hz-19.99 Hz	$\pm(0.4\%$ setting $+0.2\%$ range)
15 Hz-199.9 kHz	0.1 Hz-199.9 kHz	$\pm(0.2\%$ setting $+0.1\%$ range)
150 kHz-19.99 MHz	1 kHz-19.99 MHz	$\pm(0.01\%$ setting $+50$ ppm/yr)

#### Amplitude

**Range:** 0.01 mVp-p to 10 Vp-p into 50  $\Omega$ .

**Resolution:** 3-1/2 digits.

**Absolute Amplitude Accuracy:** 10 kHz, 1.00-10.00 Vp-p, Autorange ON

$\pm(1\%$  of display + 0.035 Vp-p), sine and square wave.

$\pm(1\%$  of display + 0.06 Vp-p), triangle.

**Flatness-sinewave:** relative to 10 kHz, 1.00V to 10.0V (range 4).

20 Hz	50 kHz	1 MHz	19.99 MHz
$\pm 0.7$ dB	$\pm 0.33$ dB	$\pm 1.5$ dB	

#### Frequency Sweep

**Linear:** 0 to 2 decades, 7.2 ms to 1999 s/sweep

**Log:** 1 to 7 decades (integer only), 40 ms to 1999 s/decade

**Manual sweep:** modify knob tunes between start and stop frequencies. X drive follows sweep.

#### Modulation Inputs:

Bandwidth	Sensitivity	Range	Z
AM: dc to 100 kHz	2 Vp-p for 100% -1 Vdc for suppressed carrier	>100%	10 k $\Omega$
FM: 100 Hz to 100 kHz	$\pm 1$ Vp for 1% of range deviation	$\pm 1\%$ of freq. range	10 k $\Omega$
VCO: dc to 100 kHz	10%/volt	+1 to -10V	10 k $\Omega$

# FUNCTION GENERATORS & WAVEFORM SYNTHESIZERS

Function Generator

HP 3314A, 3312A

431

## Waveform Characteristics

**Sine harmonic distortion:** individual harmonics will be below these levels, relative to the fundamental.

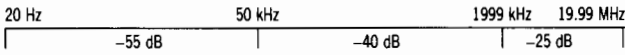

## Square wave rise/fall time:

< 9 ns, 10% to 90% at 10 V<sub>p-p</sub> output.

## N integer:

N = 1 to 1999, Preset to 1  
For Phase-lock Fin ÷ N, Fin X N  
or N CYCLE (counted burst).

**Function invert:** inverts ac portion of signal outputs.

## Phase

### Phase offset-phase lock modes

**Resolution:** 0.1°  
**Range:** ±199.9°

### Start/stop phase-burst modes

**Resolution:** 0.1°  
**Range:** ±90.0° for frequencies to 19.99 MHz.

## Trigger

### Internal trigger

**Range:** .002 ms (500 kHz) to 1999 s (0.5 mHz) square wave.  
**Period accuracy:** ± (0.01% (+ 50 ppm/year) of displayed interval (excluding sweep intervals).  
**Trigger output:** Low <0.5 V, high >2.5 V; output resistance 1 kΩ.

### External trigger

For Gate, N Cycle, 1/2 Cycle, Fin X N, Fin ÷ N, and external sweep triggers.

**Frequency range:** 50 Hz to 20 MHz.  
**Trigger slope:** selectable, positive or negative.

## Symmetry

**Symmetry range:** 5% to 95% of period, 2 Hz-2 MHz ranges

## Arbitrary waveforms

Output consists of a series of voltage ramps called vectors. Arbitrary waveforms can be composed of 2 to 150 vectors. A maximum of 160 vectors can be stored in six available storage registers with a minimum of 2 vectors per waveform. Features include MARKER and SYNC outputs and a GATE mode. Practical frequencies are 0.002 Hz to 2.5 kHz.

## Option 001 - Voltage Multiplier

Simultaneous X3 amplitude output on rear panel (into > 500 Ω.  
30 V<sub>p-p</sub> max, dc to 1 MHz.

## General

**Power:** 100/120/220/240 V + 5% -10%, 48 to 66 Hz 95 VA maximum.

**Weight:** net, 7.3kg (16lb); shipping, 10.5kg (23lb).

**Size:** 132.6H x 212.3W x 419.0mmD (5.22" x 8.36" x 16.50")

## HP-IB

IEEE Standard 488-1978 abbreviated definition.  
SH1 AH1 T6 TE0 L3 LE0 SRI RL1 PP0 DC1 DT1 C0 E2.

## Ordering Information

HP 3314A Function Generator	Price \$4,800
Opt 001 Simultaneous X3 Output	+ \$265
Opt W30 Extended Repair Service. See page 723.	+ \$115

- Two function generators in one instrument
- AM-FM, sweep, trigger, gate and burst (int & ext)

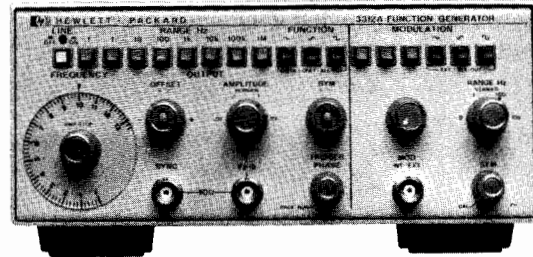

HP 3312A

## HP 3312A Function Generator

The HP 3312A Function Generator combines two separate, independent function generators with a modulator section in one compact instrument. The main generator can—via pushbutton control—be triggered by the modulation generator to provide sweep functions, AM, FM or tone burst, and includes dc offset up to 10 volts p-p into 50 Ω.

## Specification Summary

**Output waveforms:** Sine, square, triangle, ±ramp, pulse, AM, FM, sweep, triggered and gated.

## Frequency characteristics

**Range:** 0.1 Hz to 13 MHz in 8 decade ranges.  
**Dial accuracy:** ±5% of full scale. Unspecified in Uncal Mode.

**Square wave rise or fall time (10% to 90%):** <20 ns.

**Variable symmetry:** 80:20:80 to 1 MHz.

**Sine wave distortion:** <0.5% (-46 dB) THD from 10 Hz to 50 kHz. (10 kHz range maximum). (>30 dB below fundamental from 50 kHz to 13 MHz, at full-rated output.)

## Output characteristics

**Impedance:** 50 Ω ± 10%.

**Level:** 20 V<sub>p-p</sub> into open circuit, >10 V<sub>p-p</sub> into 50 Ω at 1 kHz.

**Level flatness (sine wave):** <±3% from 10 Hz to 100 kHz at full rated output (1 kHz reference). <± from 100 kHz to 10 MHz.

**Sync output:** Impedance: 50 Ω ±10% > 1 V<sub>p-p</sub> square wave into open circuit. Duty cycle varies with symmetry control.

**dc offset:** Variable up to ±10 volts. Instantaneous ac voltage + V<sub>dc</sub> offset cannot exceed ±10 V (open circuit) or ± 5 V (50 Ω).

## Modulation characteristics

**Types:** Internal and external AM, FM, sweep, trigger, gate or burst.

**Waveforms:** Sine, square, triangle, ramp or variable symmetry pulse.

**Frequency range:** 0.01 Hz to 10 kHz.

## Amplitude and frequency modulation

**Depth:** 0 to 100% (AM), 0 to 5% (internal FM)

**Modulation frequency:** 0.01 Hz to 10 kHz (internal). dc to >1 MHz (AM external), dc to >50 kHz (FM external).

## Sweep characteristics

**Sweep width:** >100:1 on any range.

**Sweep rate:** 0.01 Hz to 10 kHz, 90:10 ramp.

## Gate characteristics

**Start/stop phase range:** +90° to -80°.

**Frequency range:** 0.1 Hz to 1 MHz (useful to 10 MHz).

## External frequency control and FM

**Range:** 1000:1 on any range.

**Linearity:** 0.5% of F<sub>max</sub> for F<sub>max</sub> ≤ 1 MHz, freq. span ≤ 100:1.

## General

**Power:** 100 V, 120 V, 220 V, 240 V, +5%, -10%, switchable; 48 Hz to 440 Hz; ≤30 V A.

**Size:** 102 H x 213 W x 377 D (4" x 8.4" x 14.8").

**Weight:** net, 3.8 kg (8.4 lb); shipping, 5.9 kg (13 lb).

## Ordering Information

HP 3312A Function Generator	Price \$1600
Opt W30 Extended Repair Service. See page 723.	+ \$50

☎ For same day shipment call HP DIRECT at 800-538-8787.

# FUNCTION GENERATORS & WAVEFORM SYNTHESIZERS

## Universal Source HP 3245A

- Precision DC outputs with 6½ digits of resolution
- Synthesized AC with 0.4% amplitude accuracy
- Sine, Square, Triangle, and ARB to 1 MHz
- Ramp and pulse to 100 KHz
- Floating outputs
- Non volatile storage of up to 14 setups
- Second channel output available
- Phase continuous frequency changes
- Optional software for waveform modification
- Downloadable subroutines

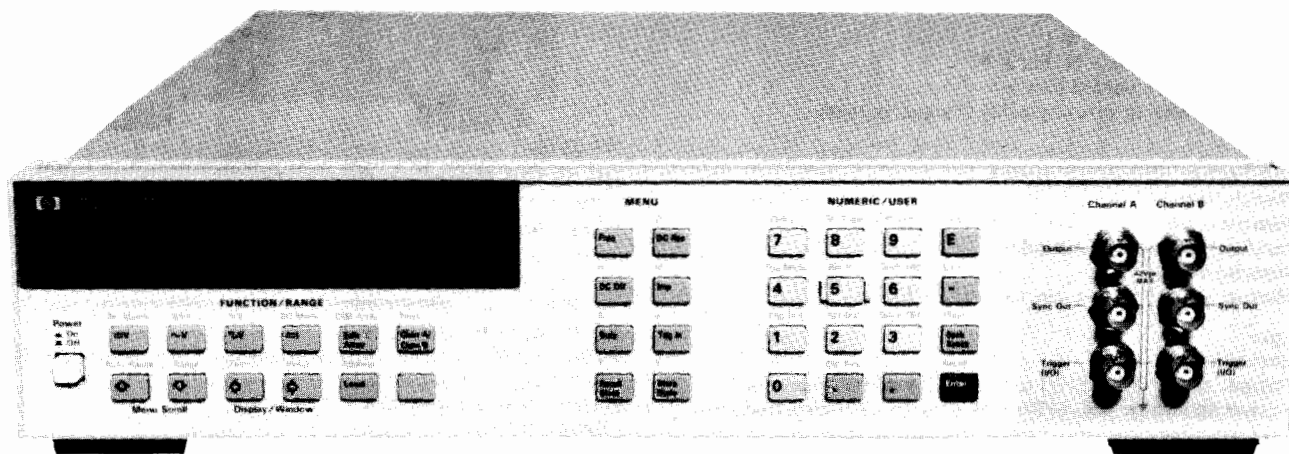

HP 3245A



### Description

The HP 3245A Universal Source offers a unique mix of precision DC capabilities with versatile AC performance, including arbitrary waveform generation. This versatility can be put to advantage on the bench, where the HP 3245A may well be all the source you will ever need. The HP 3245A can also fit into your Computer Aided Test System, providing the capabilities of AC, DC, and second channel options in a single 3.5" tall instrument.

### Precision DC

The HP 3245A provides precision DC outputs of both voltage and current. In the high-resolution mode, you get 24-bit resolution with 60 ppm, 90-day accuracy. The low-resolution mode provides 12-bit resolution with 100 usec settling times. This type of precision means you can use the HP 3245A to test A/D converters, Voltage to Frequency converters, VCO's, transducers, and anywhere that a highly accurate DC voltage or current is required. There are two output ranges in the high resolution mode;  $\pm 1$  volt and  $\pm 10$  volts. In the low resolution mode, there are 7 ranges. In current, there are four ranges of output, from 0.1 mA to 100 mA. Output impedance is selectable as either zero ohms or 50 ohms.

### Accurate AC

The HP 3245A can generate AC voltage outputs, including sine, triangle, and square waves, at frequencies of up to 1 MHz. Variable duty-cycle pulse and ramp outputs can be generated at up to 100 kHz. In the AC mode, the HP 3245A can make phase continuous frequency changes "on-the-fly". All AC waveforms are synthesized, and have 0.001 Hz resolution and 50 ppm frequency accuracy. 90-day amplitude accuracy for Sine, Ramp, and ARB is 0.35% of output + 0.41% of range.

### Second Channel Option

The addition of a second channel allows for the generation of two waveforms, either independent, or phase related to one another. The second channel output can be phase synchronized to the first channel, or to an external input. Such capabilities are especially useful if you are doing modem testing, tone sequence generation, DTMF generation, or FSK generation, or anywhere where two outputs are required.

### Arbitrary Waveform

The HP 3245A offers arbitrary waveform operation at a full 1 MHz bandwidth. This is accomplished by a sampling technique whereby the values loaded into RAM are sampled at approximately 4.3 MHz and then run through a 1.25 MHz 5-pole low-pass filter. This allows full 1 MHz rep rate while maintaining 0.001 Hz resolution at any frequency. The HP 3245A can also store multiple arrays that can be accessed for arbitrary waveform generation. Array depth is 2048 bytes.

### Waveform Generation Software

A powerful software package, useful for creating specialized waveforms, is available as an option to the HP 3245A. This menu driven software facilitates the capture of a waveform using a separate hardware digitizer, such as the HP 3458A. The waveform can then be modified, if desired. The waveform can then be played back via the HP 3245A. The use of a graphics tablet makes the modifying of waveforms especially easy. The software also contains a library of standard waveforms which can be used as is, or mixed with other waveforms to generate complex outputs.

### System Operation

The HP 3245A includes features that make it especially powerful in system applications. Because it contains many BASIC-like constructs, such as IF . . THEN and FOR . . NEXT, it is possible to have the HP 3245A do much of the work that normally would require intervention from the host computer. Now, subroutines can be downloaded to the HP 3245A, which can then run stand-alone, minimizing host computer interaction. Built in math capabilities add to the power of the HP 3245A. Electronic calibration is both easy and accurate, and does not require that the instrument be removed from a rack or opened up to perform a calibration.

All the above features combine to make the HP 3245A a truly universal source, combining precision DC outputs, accurate AC waveforms, and arbitrary waveform capabilities, all in a single instrument.



### DC Volts Output High resolution mode

Range	0 $\Omega$ Mode Resolution	50 $\Omega$ Mode Resolution
1V	1 $\mu$ V	0.5 $\mu$ V
10V	10 $\mu$ V	5 $\mu$ V

### Low resolution mode

Range	0 $\Omega$ Mode Resolution	50 $\Omega$ Mode Resolution
0.078125V	—	40 $\mu$ V
0.15625V	79 $\mu$ V	79 $\mu$ V
0.3125V	157 $\mu$ V	157 $\mu$ V
0.625V	313 $\mu$ V	313 $\mu$ V
1.25V	625 $\mu$ V	625 $\mu$ V
2.5V	1250 $\mu$ V	1250 $\mu$ V
5V	2.5 mV	2.5 mV
10V	5.0 mV	—

**Current compliance:** 100 mA on all ranges

### Settling time (Delay 0):

#### High resolution mode:

0.1% of step: 20 ms  
0.001% of step: 40 ms  
(1 s if function changed)

#### Low resolution mode:

0.1% of step (0  $\Omega$  Mode): 100  $\mu$ s  
(50  $\Omega$  Mode): 25  $\mu$ s  
0.5% of step (50  $\Omega$  Mode): 5  $\mu$ s

### Overshoot:

High Resolution Mode: <5% of step + 0.15% of range  
Low Resolution Mode: <30% of step + 2% of range

**DC Volts Accuracy** (<10 Hz noise):  $\pm$  (% of programmed output + volts), impedance mode, >1M $\Omega$  load. Tcal is the temperature of calibration from 18°C to 28°C. One hour warm-up.

### 24 Hour: Tcal $\pm$ 1C

Range	High Resolution Mode	Low Resolution Mode
10 V	0.0007% + 85 $\mu$ V	0.09% of Output + 0.02% of range
1 V	0.0008% + 15 $\mu$ V	(for all ranges)

### 90 DAY: Tcal $\pm$ 5°C

High Resolution Mode		Low Resolution Mode	
Range	Accuracy	Range	Accuracy
10V	0.0038% + 180 $\mu$ V	10V	0.17% + 37mV
1V	0.0042% + 31 $\mu$ V	5V	0.17% + 19mV
		2.5V	0.17% + 9.2mV
		1.25V	0.17% + 4.6mV
		0.625V	0.17% + 2.5mV
		0.3125V	0.17% + 1.3mV
		0.15625V	0.17% + 0.73mV

### DC Current Output Resolution

Range	High Resolution	Low Resolution
0.1mA	0.1nA	50nA
1mA	1nA	500nA
10mA	10nA	5 $\mu$ A
100mA	100nA	50 $\mu$ A

### 90 DAY: Tcal $\pm$ 5C. After one hour warm-up.

High Resolution Mode		Low Resolution Mode	
Range	Accuracy	Range	Accuracy
100mA	0.0202% + 3.3 $\mu$ A	100mA	0.32% + 400 $\mu$ A
10mA	0.0074% + 220 nA	10mA	0.30% + 52 $\mu$ A
1mA	0.0052% + 20 nA	1mA	0.25% + 3.8 $\mu$ A
0.1mA	0.0052% + 3.3 nA	0.1mA	0.25% + 0.38 $\mu$ A

### AC Volts Output Characteristics

(sine, square, ramp, arbitrary)

#### Frequency range:

0 to 1 MHz for sine, arbitrary and square (at 50% duty cycle)  
0 to 100 kHz for ramp  
0 to 100 kHz for square w/duty cycle not equal to 50%

#### Amplitude and/or offset resolution:

Range (Peak-Peak)	50 $\Omega$ Mode Resolution	0 $\Omega$ Mode Resolution
.15625V	79 $\mu$ V	—
.3125V	157 $\mu$ V	157 $\mu$ V
.625V	313 $\mu$ V	313 $\mu$ V
1.25V	625 $\mu$ V	625 $\mu$ V
2.5V	1250 $\mu$ V	1250 $\mu$ V
5V	2.5 mV	2.5 mV
10V	5.0 mV	5.0 mV
20V	—	10.0 mV

Amplitude can be set from 10% to 100% of range.

#### ac amplitude accuracy (Sine, Ramp, Arbitrary)

24 Hour: Tcal  $\pm$ 1C 0.16% of output + .25% of range  
90 Day: Tcal  $\pm$ 5C 0.29% of output + .36% of range

#### Sinewave characteristics (50 $\Omega$ Mode):

Frequency	Harmonic and Spurious Levels (amp1 $\geq$ 50% of range)*	THD (amp1 $\geq$ 50% of range)	Flatness in reference to 1 kHz
<3kHz	< -62 dB	< -56 dB	.07 dB
to 10 kHz	< -62 dB	< -50 dB	.07 dB
to 30 kHz	< -55 dB	< -48 dB	.07 dB
to 100 kHz	< -46 dB	< -46 dB	.20 dB
to 300 kHz	< -40 dB	—	.60 dB
to 1 MHz	< -40 dB	—	2.00 dB

\*additional fixed spurious response >4MHz: 500  $\mu$ Vrms

#### Squarewave characteristics (50 $\Omega$ Mode):

risetime: <250 ns, 10% to 90%  
settling time: <1  $\mu$ s to 1% of amplitude  
overshoot: < 5% of peak-to-peak amplitude  
duty cycle range: 5% to 95%, 0 to 100 kHz  
50% above 100 kHz  
duty cycle accuracy:  $\pm$ (0.8% of period + 120 ns)

#### Frequency resolution: 0.001 Hz

**Frequency accuracy:**  $\pm$ 50 ppm, 18 to 28 C

**Frequency temperature Coefficient:**  $\pm$ 1 ppm/C

#### Phase offset:

Range: -360 to +360 degrees

Resolution: < 0.001 degrees

#### Ramp linearity to 1 kHz (50 $\Omega$ Mode):

0.3% of p-p value measured @ 50% duty cycle from 10% to 90% point

**Ramp duty cycle range:** 5% to 95% with < 0.1% resolution)

### Ordering Information

HP 3245A Universal Source	Price
Opt 001 Second Channel Output	\$4,400
Opt 005 Waveform Generation Software	+\$2,600
Opt 907 Front Handle Kit	+\$400
Opt 908 Rack Flange Kit	+\$60
Opt 909 Rack flange and Handle Combination Kit	+\$35
Opt W30 Extended Warranty	+\$85
	+\$126

# FUNCTION GENERATORS & WAVEFORM SYNTHESIZERS

## Multifunction Synthesizer

HP 8904A

- Sinewaves dc to 600 kHz
- Square, ramp, triangle dc to 50 kHz
- 12-bit direct digital synthesis
- Tone, DTMF, digital, Hop Ram sequence modes
- One or two outputs
- One to four internal channels
- AM, FM,  $\phi$ M, DSBSC and pulse modulation
- External timing control of fast hop
- Unit to unit phase synchronization
- Optional 600  $\Omega$  high power, balanced output

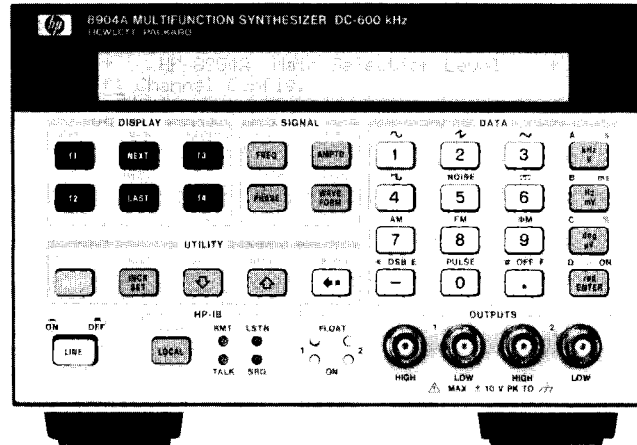

HP 8904A



### HP 8904A Multifunction Synthesizer

The HP 8904A multifunction synthesizer uses the latest VSLIC technology to create complex signals from six fundamental waveforms. The standard HP 8904A digitally synthesizes precise sine, square, triangle, ramp, white noise, and dc waveforms. Option 001 adds three more identical internal synthesizers (channels), which either can modulate the first synthesizer or be summed to the output. Option 001 also adds an FM stereo composite mode and four sequencing modes to the HP 8904A. Option 002 adds a second output providing a second separate signal for two channel applications. Option 003 adds fast hop and digital modulation capability to the HP 8904A. Option 005 allows multiple HP 8904A's to be phase-synchronized for applications that require more than two phase-related outputs. Option 006 changes output 1 from a 50 $\Omega$  output to a transformer-coupled, 600 $\Omega$  balanced output. All this unique capability makes the HP 8904A a powerful waveform generation tool for a broad spectrum of applications.

### Function Synthesizer

The HP 8904A multifunction synthesizer delivers synthesizer accurate sinewaves from 0 Hz to 600 kHz with 0.1 Hz resolution. The HP 8904A also has five other standard functions: square, triangle, ramp, dc, and Gaussian white noise. Square, ramp and triangle functions cover the 0 Hz to 50 kHz range. All waveform values in the HP 8904A are DIGITALLY calculated in real time by Hewlett-Packard's Digital Waveform Synthesis IC yielding signals with 12-bit digital accuracy and exact repeatability. Full HP-IB programmability is also included standard on the HP 8904A.

### Two Outputs

Option 002 adds a second, identical synthesizer and floating 50 $\Omega$  output section to the HP 8904A. Frequency, amplitude, waveform, and phase can be independently set for the two sources. Although both synthesizers are independent, the relative phase between the two outputs is precisely controlled. Either synthesizer can be varied in phase relative to each other, from 0 degrees to 359.9 degrees with a resolution of 0.1 degree. Testing phase detectors, servo systems, shaft encoders, sonar, and other phase-sensitive two-port devices is easy and accurate with the HP 8904A Option 002.

### Complex Signal Generation

Option 001 adds internal synthesizers for a total of four which can modulate channel A or be summed to give complex waveform generating capabilities to the HP 8904A. All four synthesizers are independent with precise phase offset capabilities. These synthesizers can be DIGITALLY summed before routing to the 12-bit digital-to-analog converter. In addition to summing, Option 001 allows channels B, C, and D to be used as modulation sources for channel A. Modulation types for channel A include: AM, FM,  $\phi$ M DSBSC, and pulse modulation. Using channel summing along with modulation of channel A, you can create many complex waveforms with the HP 8904A Option 001.

### FM Stereo Composite Mode

Option 001 also includes a special mode for generating FM stereo composite signals. Test signals in this mode include Left=Right, Left=Right, Left Only, and Right Only. Single keystrokes select test-tone frequency, composite level, test-signal mode, and pilot tone level. Digital synthesis combined with excellent analog performance yields typical stereo separation of greater than 65 dB over the full 20 Hz to 15 kHz audio bandwidth.

### Communication Signaling

Besides the extra channels and fm stereo mode, Option 001 adds four sequence modes to the HP 8904A: tone, DTMF, digital, and hop ram sequence modes. These modes make the HP 8904A a powerful tool for use in communications signaling. Tone and DTMF modes allow creation of tone sequences up to 750 states in length built from 16 user-defined tones. DTMF mode uses the sixteen standard telephone frequency pairs, while tone mode allows user entry of 16 tone frequencies. Minimum on time for each tone is 800  $\mu$ s for tone mode and 1 ms for DTMF mode. Digital sequence mode can generate bit streams up to 3000 bits in length with a minimum bit period of 100  $\mu$ s. Hop ram sequence mode allows entry of 16 tones, each with an associated amplitude, frequency, and phase value. Unlike the other sequence modes, hop ram mode uses frequency rather than time to determine sequence timing. Sequences up to 3000 states long can be created if only two of the sixteen tones are used, or 750 states long if all sixteen are used. Maximum sequence frequency is 10 kHz. All sequence modes contain extensive sequence editing features.

### Fast Hop

Option 003 adds the ability to hop the HP 8904A in frequency, phase, and/or amplitude. Up to 16 frequency/phase/amplitude states can be entered into the 'HOP RAM' memory. To hop, an external device must address the four-bit wide, TTL-level address bus provided on the rear panel. As the address supplied to the bus is varied, the HP 8904A will hop to the corresponding state stored in that hop ram memory location. Fast hop can be performed on channel A only. Phase-continuous frequency switching can be done in as little as 8  $\mu$ s. If an HP 8904A is equipped with both Options 001 and 003, channel A can be externally hopped while being modulated by or summed with internal channels B, C, and D.

### Unit-to-Unit Phase Synchronization

With Option 005, multiple HP 8904A's can be phase synchronized to provide more than two phase related outputs. In the synchronous mode, one unit is specified to be the clock controller and all others are designated clock receivers. Two signals are then routed from the clock controller unit to all clock receivers through external low-loss power splitters. To synchronize the units, a phase reset command is given to the clock controller HP 8904A via HP-IB or from the front panel. Once synchronized, all units will remain at their specified phase relationships. If the frequency or destination of any of the synchronized channels is changed, a phase reset command must be given to the clock controller to restore phase synchronization. In this mode of operation, the total phase error between units will be the larger of  $\pm 0.1$  degree or 60 ns for frequencies from 0.1 Hz to 100 kHz. Up to eight HP 8904A's may be synchronized, which will provide for a total of 16 phase-related signals if all units are equipped with option 002 (second output).

### 600-ohm Balanced Output

Option 006 changes output 1 from a 50  $\Omega$  electronically floating output to a transformer-coupled, 600  $\Omega$  balanced output. Option 006 provides high power, balanced signals into 600  $\Omega$  loads. Maximum output is 10 volts rms into 600  $\Omega$ . The option 006 output restricts the frequency range of output 1 to 30 Hz to 100 kHz (usable to 200 kHz with a typical rolloff of  $-4$  dB). In addition, complex waveforms such as square, ramp, and triangle waveforms are degraded, and dc cannot be passed through the option 006 transformer coupled output. In many applications, however, the HP 8904A option 006 is a direct replacement for the HP 200CD wide range oscillator.

### HP 8904A Specifications

(for 50  $\Omega$  output only unless otherwise noted)

#### Frequency

**Range:** Sinewave: 0 Hz to 600 kHz

Square, triangle, ramp: 0 Hz to 50 kHz

**Resolution:** 0.1 Hz

**Accuracy** (Internal 10 MHz timebase): 50 ppm

#### ac Amplitude (sinewave only)

**Range:** 0 to 10 V p-p into a 50  $\Omega$  load

**Resolution:** 3  $\frac{1}{2}$  digits (displayed, actual resolution is = voltage range / 4096)

**Accuracy (> 40 mV p-p into 50  $\Omega$ ):**

1%, 0.1 Hz to 100 kHz

3%, 100 kHz to 600 kHz

**Flatness: (> 630 mV p-p into 50  $\Omega$ ):**

$\pm 0.1\%$  ( $\pm 0.009$  dB), 0.1 Hz to 100 kHz

$\pm 1.0\%$  ( $\pm 0.09$  dB), 100 kHz to 600 kHz

#### dc Amplitude

**Range:** 0 to  $\pm 10$  V p-p open circuit

**Resolution:** 3  $\frac{1}{2}$  digits (displayed, actual resolution is = voltage range / 4096)

**Accuracy:** the larger of  $\pm 20$  mV or  $\pm 2.1\%$

### Spectral Purity (sinewave only)

**THD+N (including spurs, amplitude > 50 mV rms into 50  $\Omega$ ):**

$-63$  dBc rms (0.07%), 20 Hz to 7.5 kHz, 30 kHz BW

$-63$  dBc rms (0.07%), 7.5 kHz to 20 kHz, 80 kHz BW

$-55$  dBc rms (0.18%), 20 kHz to 100 kHz, 750 kHz BW

### Gaussian Noise

**Spectral characteristic:** Equal energy per unit bandwidth ('white').

**Time domain characteristic:** Gaussian distribution.

**Flatness (> 100 mV p-p into 50  $\Omega$ ):**

typically,  $\pm 0.5$  dB, 0.1 Hz to 100 kHz

typically,  $\pm 1.0$  dB, 100 kHz to 600 kHz

### Option 001 Specifications

Modulation is for channel A only, and specified for sinewave carrier and modulation. External modulation is NOT possible. Internal channels B, C, and D can be used to independently or collectively modulate channel A.

#### Amplitude Modulation (with Option 001)

**Rate:** 0 to 600 kHz

**Depth range:** 0% to 100 % of carrier amplitude

#### Frequency Modulation (with Option 001)

**Rate:** 0 to 600 kHz

**Deviation range:** 0 to 600 kHz

#### Phase Modulation (with Option 001)

**Rate:** 0 to 600 kHz

**Deviation range:**  $0^\circ$  to  $179.9^\circ$ /channel

#### Pulse or DSBSC Modulation (with Option 001)

**Rate:** 0 Hz to 50 kHz (up to 600 kHz for DSBSC).

#### Summation (with Option 001)

Two, three, or four channels can be summed. Two or three channels can also be summed for channel A modulation. All combinations of channels are acceptable except for: {summing channels A and C while also summing B and D} or {summing channels A and D while also summing B and C}.

#### Channel to channel phase accuracy (equal amplitude sinewaves):

the larger of  $\pm 0.1^\circ$  or 30 ns, 0.1 Hz to 100 kHz.

#### FM Stereo Composite Mode (with Option 001)

**Test modes:** Left=Right, Left=-Right, Left Only, Right Only

**Composite signal level:** up to 10 Vp-p into 50  $\Omega$

**Preemphasis modes:** Off, 25  $\mu$ s, 50  $\mu$ s, and 75  $\mu$ s

**Channel separation:**

[L-R] - typically > 65 dB, 20 Hz to 15 kHz rates

[M-S] - typically > 70 dB, 20 Hz to 15 kHz rates

#### Tone Sequence Mode (with Option 001)

**Number of frequencies:** 16 tones each with user-definable frequency, on-time and off-time

**On/Off time duration range:** 0 ms, 0.80 ms to 655.35 ms.

**Timing resolution:** 0.01 ms (10  $\mu$ s).

**Timing accuracy:**  $\pm 0.02$  ms ( $\pm 20$   $\mu$ s).

**Sequence length:** 750 steps, user definable.

#### DTMF Sequence Mode (with Option 001)

**Number of tone pairs:** 16 standard DTMF tone pairs (0-9, A-D, #, \*) with user-definable on-time and off-time.

**On/Off time duration range:** 0 ms, 1.00 ms to 655.35 ms.

**Timing resolution:** 0.01 ms (10  $\mu$ s).

**Timing accuracy:**  $\pm 0.02$  ms ( $\pm 20$   $\mu$ s).

**Sequence length:** 750 steps, user definable.

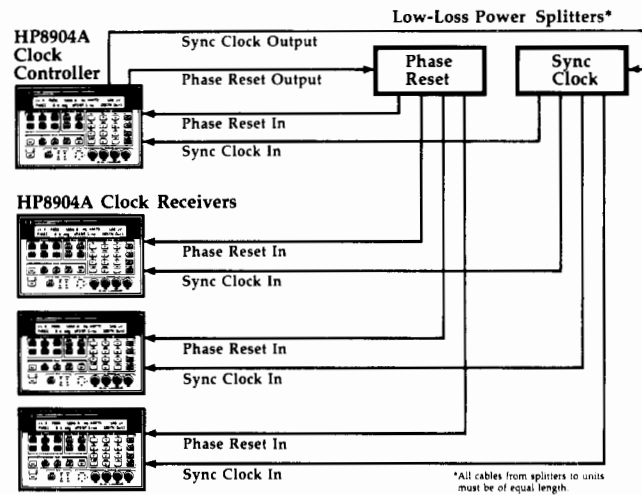
**Digital Sequence Mode (with Option 001)****User-definable:** On level, Off level, and bit period.**Bit period duration range:** 0.10 ms to 655.35 ms.**Timing resolution:** 0.01 ms (10  $\mu$ s).**Timing accuracy:**  $\pm 0.02$  ms ( $\pm 20$   $\mu$ s).**Sequence length:** up to 3000 bits, user definable.**Hop Ram Sequence Mode (with Option 001)****Number of frequencies:** 16 tones each with user-definable frequency, phase, and amplitude.**Sequence clock frequency range:** 0.1 Hz to 10 kHz.**Sequence clock frequency resolution:** 0.01 Hz.**Sequence length:** 750 steps (all 16 tones used) or 3000 steps (tones 0 and 1 used), user definable.**Option 002 Specifications (50  $\Omega$  outputs)****Output 1 to Output 2 phase accuracy (sinewaves at the same frequency):**  $\pm 0.1^\circ$  or 30 ns, 0.1 Hz to 100 kHz, whichever is greater.**Option 005 Specifications (50  $\Omega$  outputs)****Unit to unit phase accuracy (sine waves only):** the larger of  $\pm 0.1$  degree or 60 ns, 0.1 Hz to 100 kHz.**Maximum number of synchronized units:** 8 units using low-loss power splitters to connect units.**Recommended power splitters:** $\leq 4$  units synchronized: Mini-Circuits model ZSC-4-3 or equivalent. $\leq 8$  units synchronized: Mini-Circuits model ZFSC-8-1 or equivalent.**Option 006 Specifications (sine wave)**

All specifications for the standard 50  $\Omega$  output HP 8904A are degraded by the accuracy, flatness, and distortion specifications of the Option 006, 600  $\Omega$  transformer-coupled output. The Option 006 output will not pass dc and degrades the performance of square, ramp, and triangle waveforms. In addition, digital sequences available with Option 001 are degraded when output through the Option 006 transformer coupled output.

**Output type:** fully floating/balanced transformer coupled output.**Usable frequency range:** typically 30 Hz to 200 kHz**ac amplitude range:** 0 to 10 Vrms into 600  $\Omega$ **ac amplitude accuracy (> 40 mVrms into a balanced 600  $\Omega$  load):**

6 % (0.5 dB), 30 Hz to 20 kHz

12 % (1.0 dB), 30 Hz to 100 kHz

**Flatness (> 40 mVrms into a balanced 600  $\Omega$  load):**

+ 0.15 dB, - 0.15 dB, 30 Hz to 20 kHz

+ 0.15 dB, - 0.75 dB, 30 Hz to 100 kHz

**THD+Noise (including spurs, > 140 mVrms into a balanced 600  $\Omega$  load):**

-60 dB (0.10 %), 300 Hz to 7.5 kHz, 30 kHz BW

-63 dB (0.07 %), 7.5 kHz to 20 kHz, 80 kHz BW

-55 dB (0.18 %), 20 kHz to 100 kHz, 750 kHz BW

**General****Store recall:** 35 nonvolatile registers**Output type (standard unit):** 50  $\Omega$  electronic floating or grounded output, HP-IB programmable**Maximum float voltage (50  $\Omega$  output, signal+float):** 10 V peak maximum from high- or low-output to chassis ground.**Zero-crossing outputs (available in channel configuration mode only):** For each channel, a TTL-compatible zero-crossing output and polarity output are provided. The zero-crossing output pulses high for approximately 600 ns each time the corresponding channel phase goes through  $0^\circ$  and  $180^\circ$ . The polarity output is high for phases  $0^\circ$  to  $180^\circ$ , and low for  $180^\circ$  to  $360^\circ$ . These outputs do not reflect any user specified phase offsets.**External time base input:** 10 MHz accepted at a nominal level of 0.1 to 5 V peak, automatic switching**Time base output:** Output level > 0 dBm (0.3 V peak) into a 50  $\Omega$  load. Output signal will be the internal timebase unless an external timebase is connected to the external timebase input. When an external timebase is connected, it will be routed to the timebase output connector.**Operating temperature range:**  $0^\circ$  C to  $50^\circ$  C**Storage temperature range:**  $-20^\circ$  C to  $70^\circ$  C**Remote Operation:** HP-IB. All functions except the line switch are remotely controllable.**HP-IB interface capabilities:** SH1, AH1, T6, TE0, L4, LE0, SR1, RL1, PP1, DC1, DT0, C0**Power Requirements:** 100V, 120V;  $\pm 10\%$ ; 48 to 440 Hz220V, 240V;  $\pm 10\%$ ; 48 to 66 Hz, 80 VA maximum.**Weight:** net 5.9 kg (12.8 lb); shipping, 13 kg (28.6 lb)**Size:** 133 H X 213 W X 513 mm D (5.25" X 8.36" X 20.2").**EMI:** Meets conducted and radiated interference of VDE 0871/6.81 class B (radiated at 10 meters). Meets MIL 461B conducted (CE03) and radiated (RE02) interference.**Ordering Information****HP 8904A** multifunction synthesizer<sup>1</sup>. \$2,950**Opt 001** Add three (two when ordered with option 002) internal channels, Channel A modulation, summation, FM stereo mode, and sequence capability. +\$1,700**Opt 002** Add second internal synthesizer and output. +\$1,250**Opt 003** Add fast hop and digital modulation. +\$525**Opt 004** Connectors on rear panel only (not available with option 005 or 006). +\$50**Opt 005** Add unit to unit phase synchronization. +\$500**Opt 006** Change Output 1 from a 50  $\Omega$  output to a transformer coupled, 600  $\Omega$  balanced output. +\$800**Opt 910** Provides an additional operation and calibration manual (08904-90007) and two service manuals (08904-90008). +\$123 ☎**Opt 915** Adds service manual (08904-90008). +\$36 ☎**Opt W30** Extended repair service. See page 723 +\$95**Opt W32** Calibration service. See page 723 +\$255**HP 08904-61024** Rackmount kit for a single HP 8904A. +\$125**HP 08904-61025** Rackmount kit for mounting two HP 8904As side-by-side. +\$90**HP 8904A Retrofit kits (customer retrofitable):****HP 11816A** Retrofit kit for Option 001. \$1,905**HP 11817A** Retrofit kit for Option 002. \$1,520**HP 11818A** Retrofit kit for Option 003. \$620**HP 11827A** Retrofit kit for Option 005<sup>2</sup>. \$600**HP 11837A** Retrofit kit for Option 006<sup>2</sup>. \$950<sup>1</sup> HP-IB cables not included. For description and price see page 579.<sup>2</sup> not available for units with serial prefix less than 2948A.

# FUNCTION GENERATORS & WAVEFORM SYNTHESIZERS

## 1 Hz–20 MHz Pulse/Function Generator

### HP 8111A

437

- Sine, triangle, square, haversfunctions
- 20 MHz, 32 Vpp for all waveforms
- Variable duty cycle or pulse width

- Trigger, gate, VCO and optional burst
- Digital display for all parameters
- Error recognition

Picture shows 8111A with Option 001, Counted Burst.



The HP 8111A combines pulse generator and function generator capabilities in a single, compact unit. Triggered operation for all waveforms, and the ability to define rectangular waveforms in terms of pulse width or duty cycle, are examples of the HP 8111A's versatility.

### Saves Space and Equipment

Small size and manifold capability make the HP 8111A an ideal source for service and bench. Digital display, error detector and good repeatability assure high operating confidence. This reduces the need for output monitoring and consequently saves equipment.

### Flexible

Operating modes include VCO which permits frequency-shift keying and dc-to-frequency conversion as well as sweep and FM applications. Option 001's Burst mode simplifies tone burst generation and digital preconditioning by generating a precise number of waveform cycles. An "extra cycle" feature activated after a burst allows critical events to be examined.

Pulse mode's variable width down to 25 ns and clean 10 ns transitions provide useful digital test capability. High analog flexibility is assured because all waveforms can be generated in trigger, gate and burst modes. Adjustable duty cycle up to 999 kHz means that CRT sawtooth waveforms and rectangular signals for dc motor control can be simulated.

### Specifications (50-ohm load resistance)

#### Waveforms

sine, triangle, ramp, square, pulse, haversfunctions.

#### Timing

##### Frequency

**Range:** 1.00 Hz to 20.0 MHz (3-digit resolution).

**Accuracy (50% duty cycle):** 5% ( $\pm 10\%$  below 10 Hz).

**Jitter:**  $< 0.1\% + 50$  ps.

**Stability:**  $\pm 0.2\%$  (1 hour),  $\pm 0.5\%$  (24 hours).

##### Duty cycle (sine, triangle, square, haversfunctions):

	Calibrated	Variable (below 1 MHz)
Range:	50% nominal	10% to 90%.
Resolution:	2 digits	2 digits.
Accuracy:	$\pm 1$ digit	$\pm 6$ digits ( $\pm 3$ in range 20 to 80%).

##### Pulse width

**Range:** 25.0 ns to 100 ms (3-digit resolution).

**Accuracy:**  $\pm 5\% \pm 2$  ns.

### Output Characteristics

(voltages double into high impedance)

#### Amplitude

**Range:** 1.60 mVpp to 16.00 Vpp (3½ digit resolution).

**Accuracy:**  $\pm 5\%$  (at 1 kHz for sine and triangle).

**Flatness (sine, triangle):**  $\pm 3\%$  (+10%, -15% above 1 MHz).

#### Offset

**Range:** 0.00 mV to  $\pm 8.00$  V (3-digit resolution).

**Accuracy:**  $\pm 5\%$  setting  $\pm 2\%$  amplitude  $\pm 20$  mV

(ampl  $\geq 160$  mVpp),

$\pm 5\%$  setting  $\pm 2\%$  amplitude  $\pm 1$  mV

(ampl  $< 160$  mVpp).

**Distortion:** THD (1 Hz–1 MHz)  $< 3\%$  ( $-30$  dB); harmonics

(1 MHz–20 MHz)  $< -26$  d/Bc. Distortion may increase by 3 dB below  $10^\circ\text{C}$  and above  $45^\circ\text{C}$ .

**Linearity (triangle):**  $< \pm 3\%$  ( $< \pm 1\%$  below 1 MHz)

#### Pulse and squarewave performance

**Transitions:**  $< 10$  ns.

**Perturbations:**  $< \pm 5\%$  ( $< \pm 10\%$  below 0.16 Vpp).

**Output impedance:**  $\pm 50$  ohm  $\pm 5\%$ .

#### Modes

normal, trigger\*, gate\*, VCO and (Option 001) burst\*.

\*Adjustable start-phase for haversine, haverstriangle

**VCO range:** 2 decades, ext. signal 0.1 V to 10 V (dc to 1 kHz).

**Burst length:** 1 to 1999 periods for all waveforms.

#### General

**Repeatability:** factor 2.5 better than accuracy.

#### Environmental

**Storage temperature:**  $-40^\circ\text{C}$  to  $+75^\circ\text{C}$ .

**Operating temperature:**  $0^\circ\text{C}$  to  $55^\circ\text{C}$ .

**Humidity:** 95% RH,  $0^\circ\text{C}$  to  $40^\circ\text{C}$ .

**Power:** 100/120/220/240 V rms;  $+5\% - 10\%$ ; 48 to 440 Hz; 70 VA max.

**Weight:** net, 4.6 kg (10 lb). Shipping, 6.6 kg (15 lb).

**Size:** 89 H x 212.3 W x 345 mm D (3.5" x 8.36" x 13.6").

#### Ordering Information

HP 8111A Pulse/Function Generator

Opt 001 Burst

Opt 910 Extra Operating and Service Manual

Opt W30 Extended Repair Service

HP 5062-4001: Bail Handle Kit

HP 5062-3972 Rack Mount Kit (single HP 8111A)

HP 5062-3974 Rack Mount Kit (two instruments)

HP 5062-3994 Lock Link Kit (for use with

HP 5062-3974)

☎ For same-day shipment, call HP DIRECT at 800-538-8787

#### Price

\$2,500

+ \$480

+ \$39

\$65

\$38

\$51

\$31

\$40

# FUNCTION GENERATORS & WAVEFORM SYNTHESIZERS

## Dual Arbitrary Waveform Generator

HP 8175A Option 002

- 2 analog channels / 1 kpoints ea / 50 MHz ea
- individual datapoint durations 20 ns to 9.99 s
- 10 bit amplitude resolution
- digital and analog signals simultaneously
- 4 waveform entry modes; calculator, graphical editing, abs. and rel. levels, various codings
- up to 32 Vp-p output voltage (into open), separately programmable offset (max  $\pm 16$  V)

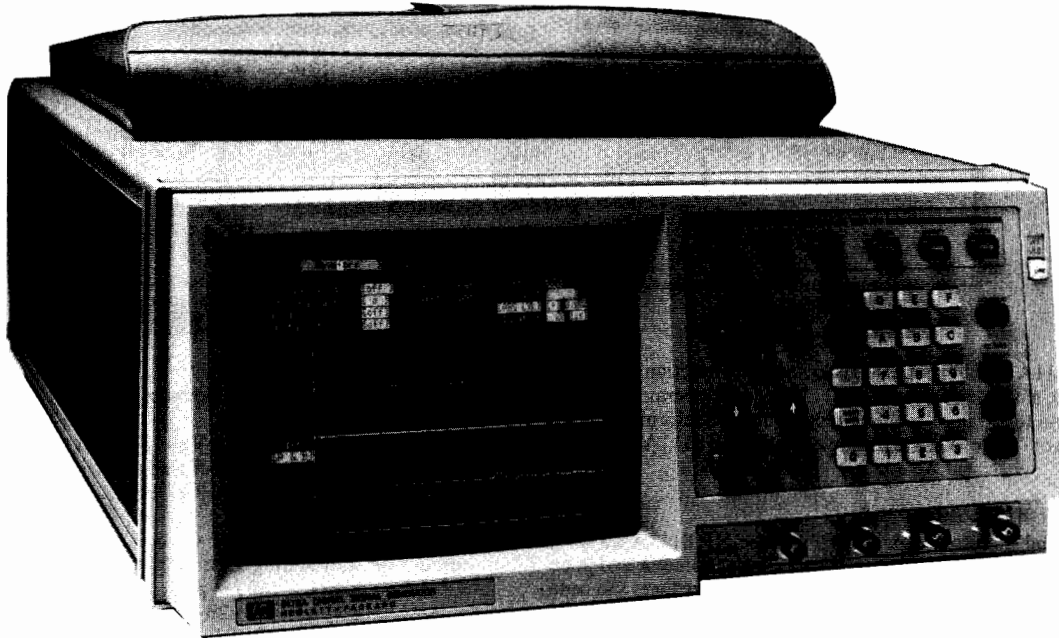

HP 8175A, Option 002; Data Page:  
Waveform Setup

With the Option 002, the Dual Arbitrary Waveform Generator, the HP 8175A offers the new Arbitrary Waveform mode in addition to the existing Parallel and Serial modes. In the Arbitrary Waveform mode, you have: Dual arbitrary waveform channels, and simultaneous equivalent digital signals. This means you have the ideal source for difficult applications, for example:

- simulation of two dependent variables, like force and distance, at the same time.
- digital and analog stimulation of devices like programmable filters.
- stimulus and compare signals at the same time for DACs or ADCs.

The arbitrary outputs are 50 Mpoints/s, synchronous, but independent in shape and amplitude (max 16 V p-p into 50 Ohm and max 32 V p-p into open), and the waveforms can be set up by means of: a) algorithms (a fundamental set of mathematical functions are available, including noise), b) interpolations (linear and spline), c) graphic or tabular entry of instantaneous level (or amplitude and offset), d) tabular entry of equivalent digital pattern. Additionally, any existing waveform can be modified. One way is simply by tabular or graphical editing. A more powerful alternative is the "Combine" feature. This allows you to combine an algorithm arithmetically with any desired part of the current waveform.

### Application Examples

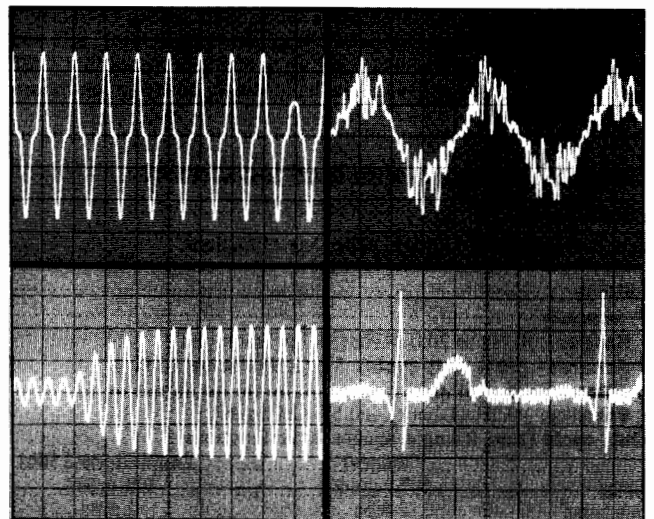

The comprehensive feature set, together with the outstanding memory management and interaction capability, mean that "real-life" simulation for the most exacting circuits is within your grasp.

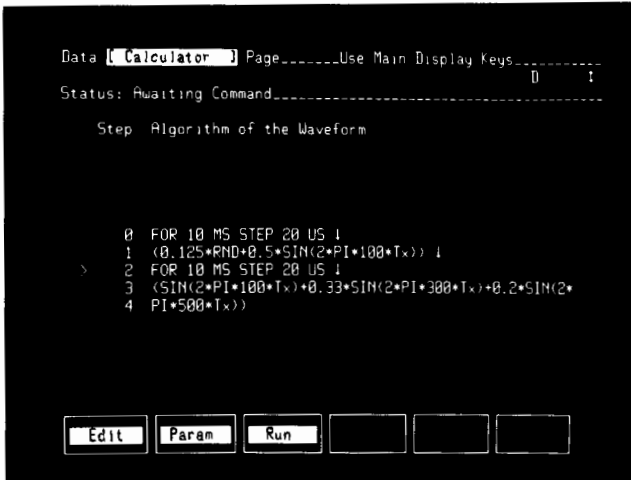

### Data Page: Calculator

The built-in Calculator provides a comfortable method of setting up very complex, mathematically-definable waveforms by simply entering the formula. Softkeys support most of the fundamental mathematical functions. The Combine capability allows any previously generated function to be combined with the current calculated function. By this means, noise can be introduced into any desired parts of the waveform.

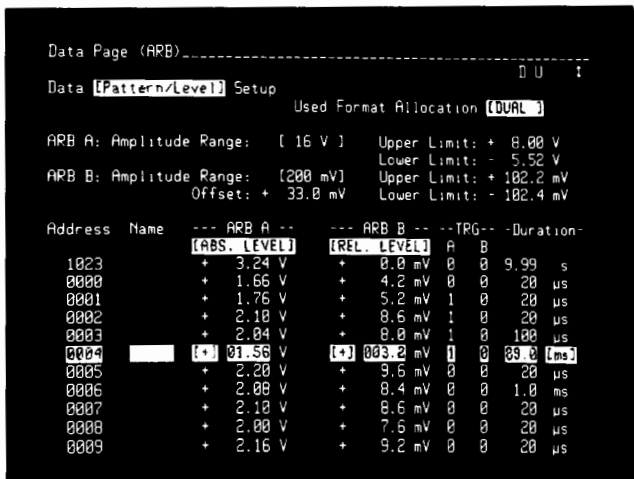

### Data Page: Pattern/Level Set-Up

Data Points of a waveform can be entered and displayed in absolute or relative levels or in various codes. Comprehensive waveform editing support is provided. For instance, segments of data points can be moved or copied to other memory locations or waveform segments can easily be exchanged between the two analog channels. In this way it is easy to produce phase shifted signals. Graphical editing of the waveform, including interpolation between data points, is possible on this menu.

### Specifications

apply for operating temperatures from 0° to 55°C.

### Option 002 Dual Arbitrary Waveform Generator (can be retrofitted in HP service office)

**Number of Analog Outputs:** 2

**Number of Bits:** 10

**Number of Data Points:**

**Horizontal:** 1024 points

**Vertical:** 1000 points with additional 24 points override

800 points for 16 V p-p Output Voltage Range

640 points for 32 V p-p Output Voltage Range

**Differential Non-Linearity:** ≤1 LSB (monotonic)

**Output Impedance:** 50 Ohm ±5%

### Output Levels

**Load Impedance:** 50 Ohm:

**7 Output Voltage Ranges:** 0.2 V to 16 V, Res. 0.2 mV to 20 mV

**2 Offset Ranges:** ±0.8 V and ±8 V (Output Volt. Range >1 V)

**Load Impedance:** ≥50 kOhm

**7 Output Voltage Ranges:** 0.5 V to 32 V, Res. 0.5 mV to 50 mV

**2 Offset Ranges:** ±1.6 V and ±16 V (Output Volt. R. >2V)

### Accuracy (Output A and Output B)

**Amplitude Accuracy:** ±4% ±4 LSB

**Offset Accuracy:** ±1% of programmed value

±2% of (progr. High Level of p-p Output Volt. +

progr. Low Level of p-p Output Volt.) (if High and

Low Level are identical in magnitude, but opposite in sign, this error will be zero).

plus:

**into 50 Ohm:** ±10 mV for 0.2 V, 0.5 V and 1 V ranges

**or:** ±25 mV for 2 V and 5 V range

**or:** ±50 mV for 10 V and 16 V range

**into ≥50 kOhm:** ±20 mV for 0.5 V, 1 V and 2 V ranges

**or:** ±50 mV for 5 V and 10 V range

**or:** ±100 mV for 20 V and 32 V range

### Timing (for Output A and B)

The maximum sample update rate is 50 MHz.

The Data Point Duration is 20 ns to 9.99 s.

### Trigger Output Characteristics:

**Number of Trigger Output Channels:** 2

**Trigger Output Impedance:** 50 Ohm ±5%

**Trigger Output Levels:** ECL into 50 Ohm

TTL into 50 Ohm and ≥50 kOhm

**Trigger Pulse Width:** The trigger can be set for each individual data point to High Level or Low Level. The trigger width depends on the programmed Data Point Duration.

### Ordering Information

**HP 8175A** Digital/Analog Signal Generator

Note: HP 8175A must be ordered with at least option #002 or one of the digital options (refer to page 465).

**Opt. 002** Dual Arbitrary Waveform Generator

**Opt. 908** Rack Flange Kit (P/N 5062-3978)

**Opt. 910** Additional Operating/

Programming/Service Manual

**Opt. 916** Additional Programming Manual

**W30** Extended repair service (see page 723)

☎ For same-day shipment, call HP DIRECT at 800-538-8787

### Price

\$11,900

\$3,650

\$36

\$290

\$72

\$280

# FUNCTION GENERATORS & WAVEFORM SYNTHESIZERS

## 1 MHz–50 MHz Pulse/Function Generator

HP 8116A

- Sine, triangle, square, haversine functions and dc
- 1 MHz–50 MHz, 32 Vpp for all waveforms
- Variable (10 ns min) pulse width, 6 ns transitions
- Modulation
- Self-prompting operating concept
- Error recognition and self test



Picture shows 8116A with Option 001, Burst and Logarithmic Sweep.

Supported by  
**HP ITG**  
Software

The fully programmable HP 8116A features pulse as well as function generator capabilities in one small unit. A broad 1 MHz–50 MHz band for all waveforms and a wide choice of operating and modulating modes assure high flexibility. These factors, plus good repeatability, make the HP 8116A a sound, long-term investment.

### Unique Operating Concept Saves Engineering Time

HP's custom IC's have made it feasible to put the many HP 8116A capabilities into such a small volume. Handling is simplified by a unique, microprocessor-controlled, operating concept which ensures a clear overview of the compact front panel at all times. When the mode and waveform have been selected, illuminated labels show which parameters must be set. There's no clutter, no confusion.

**Auto vernier.** In normal mode, the HP 8116A's auto-vernier increments any desired parameter continuously until a stop signal is applied. This means that thresholds can be measured automatically, without a controller.

**Level or amplitude programming.** The HP 8116A's output can be programmed in terms of high and low levels or in terms of amplitude and offset. Consequently a direct, automatic, conversion is always feasible so that the HP 8116A can be programmed in the same terms as the device is specified.

**Safe limit.** Devices can be protected by the limit feature. This prevents the output from exceeding a given magnitude.

### Rectangular Waveforms

For applications such as laser diodes or dc motors, square waves can be programmed for constant duty cycles from 10% to 90%. For digital test, or for simulating very low duty-cycle events, pulse width can be programmed down to 10 ns. Square wave and Pulse modes provide clean 6 ns edges that are ideal for many technologies. Pulse width modulation and pulse recovery capability are available in Pulse mode.

### Sine and Triangle Functions

10% to 90% duty cycle, programmable in 1% steps, provides ramps and asymmetrical sine waves for testing VCO's, servos, amplifier linearity and industrial process control systems. Haversine functions,

available in External Trigger, Gate and Burst modes, extend the applications to areas such as telephone line and vibration testing.

### Modulation

All waveforms can be amplitude or frequency modulated. VCO operation allows frequency variation over two decades with an external voltage; consequently transducer output can be conditioned for mag tape recording, or frequency-shift keying or linear sweep can be carried out.

### Option 001

**10 1/2-decade log sweep.** Sweep mode covers the wide 1 MHz – 50 MHz band in a single up sweep. Test setups require no more than an X-Y recorder or scope because all necessary control signals are available. The HP 8116A sweeps can be internally triggered, if desired.

**Accurate, counted bursts.** A preprogrammed number of cycles of any waveform can be generated in Burst mode. With sine, triangle and square functions, bursts can be triggered internally as well as externally.

**Hold capability.** For material stress testing, low frequency functions can be held at instantaneous levels. Hold is controlled by an external signal.

### Low-Cost Automation for Bench and Systems

Powerful capability, small size and wide specified temperature range make the HP 8116A a good choice for automatic test systems. Also, the low cost means that it's now realistic to automate those routine bench jobs and leave more time for design. Comfortable software features such as easy syntax and flexible format contribute to rapid system design.

### Operating Confidence

There's reliance in the HP 8116A's output because proper operation is always ensured by the instrument's error detector. This helps the user to recover from an incorrect front panel or programming operation by indicating the offending parameter. Also, the built-in test and diagnosis feature verifies correct function each time the instrument is switched on.



## Specifications

Specifications apply with 50-ohm load and temperatures in the range 0°C to 55°C.

### Functions

Sine, triangle, ramp, square, pulse, haversine, havertriangle, dc.

### Timing

#### Frequency

**Range:** 1 mHz to 50 MHz (3-digit resolution).

**Accuracy**<sup>1</sup> (pulse mode, 50% d/c):  $\pm 3\% \pm 0.3$  MHz below 100 kHz,  $\pm 5\%$  above 100 kHz.

**Jitter** (pulse mode, 50% d/c):  $< 0.1\% + 100$  ps.

**Stability:**  $\pm 2\%$  (1 hour),  $\pm 5\%$  (24 hours).

**Duty cycle:** (sine, triangle, square, haversine, havertriangle).

**Range:** 10% to 90% (20% to 80% above 1 MHz, 50% above 10 MHz), 2-digit resolution.

**Accuracy**<sup>1</sup>:  $\pm 0.5$  digits ( $\pm 3$  digits above 1 MHz).

#### Pulse Width

**Range:** 10.0 ns to 999 ns (3-digit resolution).

**Accuracy**<sup>1</sup>:  $\pm 5\% \pm 2$  ns.

**Jitter:**  $< 0.1\%$  ( $0.2\% + 200$  ps for width  $\leq 10$   $\mu$ s).

### Output Characteristics

(voltages double into high impedance).

#### Amplitude

**Range:** 10.0 mVpp to 16.0 Vpp (3-digit resolution).

**Accuracy**<sup>1</sup>:  $\pm 5\%$  (at 1 kHz for sine and triangle).

**Flatness (sine):**  $\pm 3\%$  ( $\pm 5\%$  above 1 MHz,  $+5$ – $-15\%$  above 10 MHz).

**Flatness (triangle):**  $\pm 3\%$  ( $\pm 5\%$  above 1 MHz,  $+5$ – $-25\%$  above 10 MHz).

#### Offset and dc Mode

**Range:** 0.00 to  $\pm 7.95$  V (0 to  $\pm 795$  mV for amplitude  $< 100$  mVpp).

**Resolution:** 3 digits.

**Accuracy**<sup>1</sup>: 0.5% of setting  $\pm 1\%$  of ampl  $\pm 40$  mV ( $+2$  mV if ampl  $< 100$  mVpp,  $\pm 20$  mV in dc mode).

**Distortion** (sine, normal mode, 50% duty cycle).

**Total harmonic distortion (10 Hz–50 kHz):**  $< 1\%$  ( $-40$  dB)\*.

**Harmonic related signals (50 kHz–1 MHz):**  $< -34$  dB,  
(1 MHz–50 MHz):  $< -23$  dB\*.

\*May increase by 3 dB below 10°C and above 45°C.

**Non-linearity** (triangle, ramp, 100 mHz–1 MHz):  $< \pm 3\%$ .

### Pulse and Square Wave Characteristics

**Transitions:**  $< 7$  ns.

**Pulse perturbations:**  $< \pm 5\% \pm 2$  mV.

**Output impedance:** 50 ohm  $\pm 5\%$ .

### Operating Modes

Normal, trigger\*, gate\*, external width.

### Additional Modes in HP 8116A Option 001

**Logarithmic Up Sweep** (for all waveforms).

**Range:** Start and stop frequencies selectable up to full range (1 mHz–50 MHz).

**Sweep time:** selectable in 1-2-5 sequence from 10 ms to 500 seconds per decade.

**Sweep repetition:** continuous sweeps (internal sweep) or externally triggered.

**Counted Burst\*** (for all waveforms).

**Burst length:** 1 to 1999 cycles.

**Burst repetition:** internally triggered at selectable intervals from 100 ns to 999 ms (except in Pulse mode), or externally triggered, up to 40 MHz.

\*Selectable ( $-90^\circ$ ) start-phase for haversine, havertriangle.

### Control Modes

**Frequency modulation:**  $\pm 5\%$  max deviation.

**Sensitivity:** 1 V for 1% deviation.

**Modulating frequency:** dc to 20 kHz.

### Amplitude Modulation

**Sensitivity:**  $\pm 2.5$  V for 100% mod. ( $+2.5$  V to  $-7.5$  V for DSBSC).

**Modulating frequency:** dc to 1 MHz.

<sup>1</sup>Applies from 15°C to 35°C, %-error increases 0.05 per °C outside this range.

### Pulse Width Modulation

**Range:** 10 ns to 1 s in 8 non-overlapping decade ranges.

Max. width ratio: 10:1.

**Sensitivity:**  $\pm 9$  V for 1:10 ratio.

### Voltage-Controlled Oscillator

**Range:** 2 decades in range 1 MHz–50 MHz.

**Sensitivity:** 0.1 V to 10 V for 2 decades.

**Modulating frequency:** dc to 1 kHz.

### Auxiliary Modes

**Manual:** simulates external input.

**1 cycle (option 001):** triggers single output cycle in Trigger, Gate and Ext Burst modes.

**Auto vernier:** continuous vernier which can be remotely or manually stopped.

**Limit:** programmable maximum output levels to protect DUT.

**Complement:** selectable normal/complement output.

**Disable:** relay disconnects output.

### Auxiliary Inputs and Outputs

#### External Input

**Threshold:**  $\pm 10$  V adjustable.

**Max input voltage:**  $\pm 20$  V.

**Sensitivity:** 500 mVpp.

**Min pulse width:** 10 ns.

**Input impedance:** 10 k $\Omega$  typ.

**Trigger slope:** positive, negative and off.

#### Control Input

**Max input voltage:**  $\pm 20$  V.

**Input impedance:** 10 k $\Omega$  typ.

#### Trigger Output

**Output levels:** 0/2.4 V typ.

**Output impedance:** 50 ohm typ.

**X-Output** (Option 001) for sweep X-Y recording (rear panel).

**Output levels:** 0 V (= start frequency) to 10 V max.

**Slope:** 1.5 V per sweep decade.

**Marker Output** (Option 001) for sweep (rear panel).

**Output levels:** TTL

**Leading edge:** positive at selected marker frequency.

**Hold Input** (Option 001), rear panel.

**Input levels:** TTL

**Leading edge:** positive transition causes HP 8116A output (f  $< 10$  Hz) to hold at instantaneous level. Output droop 0.01% per second.

**Max input voltage:**  $\pm 20$  V

### HP-IB Capability

All manual key operations are programmable. Talk mode provides learn, status byte and error report capabilities.

### Memory

Battery-backup RAM retains current operating state.

### General

**Repeatability:** factor 4 better than accuracy.

### Environmental

**Storage temperature:**  $-40^\circ\text{C}$  to  $+70^\circ\text{C}$ .

**Operating temperature:**  $0^\circ\text{C}$  to  $55^\circ\text{C}$ .

**Humidity:** 95% RH,  $0^\circ\text{C}$  to  $40^\circ\text{C}$ .

**Power:** 100/120/220/240 V rms;  $+5\%$ ,  $-10\%$ ; 48 to 440 Hz; 120 VA max.

**Weight:** net, 5.9 kg (13 lb). Shipping, 8.0 kg (18 lb).

**Size:** 89 H x 212.3 W x 422 mm D (3.5" x 8.36" x 16.6").

### Ordering Information

HP 8116A Programmable Pulse/Function Generator\* \$3,775

Opt. 001: Burst and Logarithmic Sweep +\$510

Opt. 910: Extra Operating & Service Manual +\$41

Opt. W30: Extended Repair Service. See page 725 \$95

HP 5062-4001: Bail Handle Kit \$38

HP 5062-3972: Rack Mount Kit (single HP 8116A) \$51

HP 5062-3974: Rack Mount Kit (two instruments) \$31

HP 5062-3994: Lock Link Kit (for use with HP 5062-3994) \$40

\*HP-IB cables not supplied, see page 579.

☎ For same-day shipment, call HP DIRECT at 800-538-8787



### Prices

\$3,775

+\$510

+\$41

\$95

\$38

\$51

\$31

\$40



# FUNCTION GENERATORS & WAVEFORM SYNTHESIZERS

## 50 MHz Programmable Signal Source

HP 8165A

- Pulse/function capability
- Sine, triangle, square to 50 MHz
- Pulses and ramps to 20 MHz
- Trigger, gate and counted burst
- Synthesizer stability, precision amplitude
- Storage of operating parameters

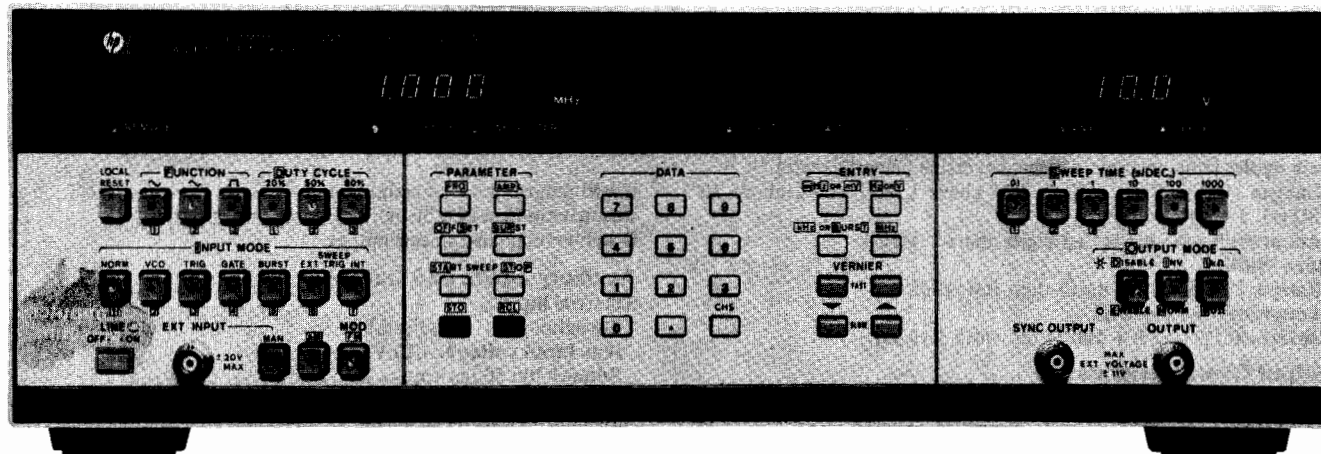

Picture shows 8165A with option 002, AM and Logarithmic Sweep.

### Versatility and Simplicity for Systems and Bench

The HP 8165A Programmable Signal Source is a versatile function generator with good accuracy and many trigger features. Microprocessor control assures rapid, accurate setup whether programming locally or via HP-IB.

### Operating Set Storage

Ten complete sets of operating information can be stored and recalled. In the event of power failure, battery back up retains all data plus the active settings.

### Stability and Resolution

Stable frequency is ensured with an internal crystal. The four-digit frequency display provides a 1  $\mu$ Hz resolution in the 1 to 9.999 MHz range. In Normal mode, the accuracy is 0.001% with a stability of  $\pm 1 \times 10^{-6}$ .

### Specifications

#### Waveforms and Frequency Range

**Sine, square, triangle (50% duty cycle):** 1.000 mHz to 50.00 MHz.

**Pulse/ramp (20, 80% symmetry):** 1.000 mHz to 19.99 MHz.

**Haversine/havertriangle:** please inquire for special option.

#### Output Characteristics

**Range:** amplitude and offset independently variable within  $\pm 10$  V window.

**Source impedance:** selectable 50  $\Omega \pm 1\%$  or 1 k $\Omega \pm 10\%$

**Amplitude:** 10.0 mVpp to 10.0 Vpp (50  $\Omega$  into 50  $\Omega$ )  
2.00 Vpp to 20.0 Vpp (1 k $\Omega$  into 50  $\Omega$ )

Accuracy	Sine V Vrms	Square	Triangle (50%)	Ramp (20%–80%)	Pulse (20%–80%)
<1kHz	$\pm 3\%$	$\pm 2\%$	$\pm 3\%$	$\pm 3\%$	$\pm 2\%$
1kHz–4.99MHz	$\pm 3\%$	$\pm 2\%$	$\pm 3\%$	$\pm 5\%$	$\pm 2\%$
5 MHz–19.9MHz	$\pm 8\%$	$\pm 5\%$	$\pm 10\%$	$\pm 10\%$	$\pm 5\%$
20MHz–50MHz	$\pm 8\%$	$\pm 5\%$	+5% to –20%	–	–

**Offset:** 0  $\pm 10$  mV to  $\pm 5.00$  V (50  $\Omega$  into 50  $\Omega$ )  
0  $\pm 20$  mV to  $\pm 10.0$  V (1 k $\Omega$  into 50  $\Omega$ )

**Accuracy:**  $\pm 1\%$  programmed value  $\pm 1\%$  signal Vpp  $\pm 20$  mV.

#### Sine Characteristics

**Distortion:** total harmonic distortion (THD) for fundamental up to 1 MHz: 38 dB.

**Harmonic signals:** (fundamental above 1 MHz):  $\leq -30$  dBc.

#### Square/Pulse Characteristics

**Transition times:** (10% to 90%):  $\leq 5$  ns (50  $\Omega$  into 50  $\Omega$ ),  $\leq 7$  ns (1 k $\Omega$  into 50  $\Omega$ )

**Preshoot/Overshoot/Ringing:**  $\leq \pm 5\%$  (50  $\Omega$  into 50  $\Omega$ ),  $\pm 10\%$  (1 k $\Omega$  into 50  $\Omega$ ).

#### Triangle/Ramp Characteristics

**Linearity:** (10% to 90%):  $\leq \pm 1\%$  ( $\leq \pm 5\%$  above 5 MHz).

### Operating Modes

**Norm** (continuous phase locked), **VCO** (external sweep voltage),

**Trig** (ext or man. one-shot), **Gate**, **Burst** (1–9999 counted cycles),

#### Frequency Modulation

**HP-IB:** control and learn capability for all modes and parameters.

**Interface functions\*:** SH1, AH1, T6, L4, SR1, RLI, PP0, DC0, DT1, C0, E1.

### General

**Memory:** non volatile. 10 addressable locations plus one for active operating state. Each location can store a complete set of operating parameters and modes.

**Power:** 100/120/220/240 Vrms;  $\pm 5\%$ ,  $-10\%$ ; 48 to 66 Hz, 200 VA max.

**Operating temperature:** 0° to 50°C

**Weight:** net 12 kg (26.5 lbs). Shipping 16 kg (35.3 lbs).

**Size:** 133 H x 426 W x 422 mm D (5.2" x 16.8" x 16.6").

### Ordering Information

**HP 8165A Programmable Signal Source\*\***

**Opt. 002:** AM and logarithmic sweep

**Opt. 003:** Rear Panel Connectors

**Opt. 907:** Front Handle Kit (Part No HP 5062-3989)

**Opt. 908:** Rack Mount Flange Kit (Part No HP 5062-3977)

**Opt. 909:** Opt 907, 908 combined (Part No HP 5062-3983)

**Opt. 910:** Additional Operating and Service Manual

**Opt. W30:** Extended repair service see page 723.

\*For more on these codes refer to the HP-IB section of this catalog.

\*\*HP-IB cables not supplied, see page 579.

☎ For same-day shipment, call HP DIRECT at 800-538-8787

### Price

\$8850

\$1150

\$0

\$56

\$33

\$82

\$71

\$210

# FUNCTION GENERATORS & WAVEFORM SYNTHESIZERS

Synthesizer/Function Generator 1  $\mu$ Hz to 21 MHz

HP 3325B, 3326A

443

- Fully synthesized microhertz resolution
- Functions—sine, square, triangle, ramps, arbs, dc offset
- Internal programmable modulation source
- Log, lin, discrete sweep
- Excellent signal purity
- dc to 60 MHz SYNC output

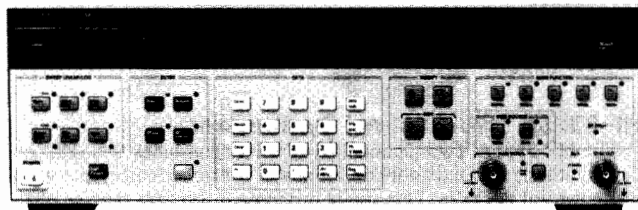

DESIGNED FOR  
MATE  
SYSTEMS

HP 3325B

## HP 3325B Synthesizer/Function Generator

The HP 3325B is a 1  $\mu$ Hz to 21 MHz synthesizer/function generator with high performance, exceptional versatility and value. Testing is made fast and efficient in general purpose applications whether on the bench or in ATE systems.

### Synthesizer Precision

HP 3325B frequency accuracy is determined by a precision frequency reference and can be set with a resolution of 1  $\mu$ Hz. It has up to -65 dBc harmonic and -70 dBc spurious levels for precision measurements. The phase of the output signal can be precisely controlled  $\pm 719.9$  deg with 0.1 deg resolution, and multiple HP 3325Bs can be locked together for multi-phase applications.

### Function Generator Versatility

Precision squarewaves to 10,999,999 MHz have 20 ns risetimes with synthesizer accuracy and precision. Triangle and ramp waveshapes are also available with .05% linearity up to 10,999,999 kHz. DC and phase offset can be added to these waveshapes. The modulation source can be used as an arbitrary function generator via HP-IB, providing user-defined waveshapes. These features make the HP 3325B one of the most versatile sources for bench or ATE system applications. Save-recall memory includes 10 non-volatile memory locations, for simple and rapid access to frequently used test setups.

### Discrete Sweep

The enhanced feature set of the HP 3325B includes 100-segment discrete sweep capability which allows arbitrarily defined multi-segment linear or stepped sweeps and tone sequences. This complies its linear and log, phase continuous sweep capability.

### Internal Modulation Source

A built-in programmable modulation source provides sine, square and arbitrary waveshapes for internal amplitude or phase modulation, or for use as a second source. In addition, a rear panel sync output provides a TTL compatible dc to 60 MHz signal with 1  $\mu$ Hz resolution for use as a precision, high-resolution clock signal, and extended frequency coverage.

### ATE Systems Compatibility

All functions, including frequency, amplitude, phase, modulation, sweep and waveshapes, are programmable via HP-IB or RS 232 interface. The HP 3325B is fully compatible in form, fit and function with the HP 3325A. All HP-IB programs written for the HP 3325A are fully compatible with the HP 3325B.

## Specifications

### Waveforms

Sine, square, triangle, negative and positive ramps.

### Frequency

#### Range

**Sine:** 1  $\mu$ Hz to 20,999 999 999 MHz

**Square:** 1  $\mu$ Hz to 10,999 999 999 MHz

**Triangle/ramps:** 1  $\mu$ Hz to 10,999 999 999 kHz

**Resolution:** 1  $\mu$ Hz, < 100 kHz

1 mHz  $\geq$  100 kHz

**Accuracy:**  $\pm 5 \times 10^{-6}$ , 20° to 30°C at time of calibration

**Warm-up time:** 20 minutes to within specified accuracy

### Main signal output (all waveforms)

**Impedance:** 50  $\Omega$

**Connector:** BNC; switchable to front or rear panel, nonswitchable with option 002, except by internal cable change.

### Amplitude

**Range:** 1 mV to 10 Vp-p in 8 amplitude ranges, 1-3-10 sequence (10 dB steps), into 50  $\Omega$  load.

Function	Sine		Square		Triangle/Ramps	
	min	max	min	max	min	max
Units Displayed						
peak-peak	1.000 mV	10.00 V	1.000 mV	10.00 V	1.000 mV	10.00 V
rms	0.354 mV	3.536 V	0.500 mV	5.000 V	0.289 mV	2.887 V
dBm (50 $\Omega$ )	-56.02	+23.98	-53.01	+26.99	-57.78	+22.22

**Resolution:** 0.03% of full range or 0.01 dB (4 digits).

**Amplitude accuracy** (without dc offset, relative to programmed amplitude and accuracy)

### Sine wave amplitude accuracy

1 mHz to 100 kHz:  $\pm 0.1$  dB,  $\geq 3$  Vpp;  $\pm 0.2$  dB, < 3 Vpp

100 kHz to 20 MHz:  $\pm 0.4$  dB,  $\geq 3$  Vpp;  $\pm 0.6$  dB, 0.1 to 3 Vpp

### Sine wave spectral purity

**Phase noise:** -60 dB for a 30 kHz band centered on a 20 MHz carrier (excluding  $\pm 1$  Hz about the carrier) with high-stability option 001 installed.

**Spurious:** all non-harmonically related output signals will be more than 70 dB below the carrier (60 dB with dc offset) or less than -90 dBm, whichever is greater.

**Sine wave harmonic distortion:** harmonically related signals will be less than the following levels (relative to the fundamental) at full output for each range:

0.1 Hz	50 kHz	200 kHz	2 MHz	15 MHz	20 MHz
-65 dB	-60 dB	-40 dB	-30 dB	-25 dB	

### Square wave characteristics

**Rise/fall time:**  $\leq 20$  ns, 10% to 90% at full output

**Overshoot:**  $\leq 5\%$  of peak to peak amplitude, at full output

**Settling time:** < 1  $\mu$ s to settle to within .05% of final value.

### DC offset

**Range:** dc only (no ac signal): 0 to  $\pm 5.0$  V/50  $\Omega$ .

**dc + ac:** Maximum dc offset  $\pm 4.5$  V on highest range, decreasing to  $\pm 4.5$  mV on lowest range.

**Resolution:** 4 digits

### Sine wave amplitude modulation

**Modulation depth at full output for each range:** 0-100%

**Modulation frequency range:** dc to 400 kHz (0-21 MHz carrier frequency)

**Sensitivity:**  $\pm 5$  V peak for 100% modulation

### Sine wave phase modulation

**Range:**  $\pm 850^\circ$ ,  $\pm 5$  V input

**Modulation frequency range:** dc -5 kHz

# FUNCTION GENERATORS & WAVEFORM SYNTHESIZERS

## Two Channel Synthesizer, DC to 13 MHz

HP 3325B, 3326A

### Frequency sweep

#### Sweep time

**Linear:** 0.01 s to 1000s.

**Logarithmic:** 1 s to 1000s single, 0.1 s to 1000s continuous.

#### Discrete sweep

**Number of segments:** 100 maximum.

**Time/Segment:** 0.01 s to 1000s, 0.01 s resolution.

**Maximum sweep width:** full frequency range of the main signal output for the waveform in use, except minimum log start frequency is 1 Hz.

**Phase continuity:** sweep is phase continuous over the full frequency range of the main output.

### Modulation source

**Frequency range:** sine 0.1 Hz to 10 kHz, square 0.1 Hz to 2 kHz.

**Frequency accuracy:** 0.1%, typical.

**Impedance:** drives 10 k $\Omega$  or greater load.

**Sinewave purity:** -34 dBc or better, typical.

**Waveforms:** sine, square, arbitrary.

### Auxiliary inputs and outputs

**Auxiliary frequency output:** 21 MHz to 60.999 999 999 MHz, under range coverage to 19.000 000 001 MHz, frequency selection from front panel; 0 dBm; output impedance 50  $\Omega$ .

**Sync output:** square wave with V (high)  $\geq$  1.2 V, V (low)  $\geq$  0.2 V into 50 Ohm. Frequency range is the same as main signal for front panel sync and dc to 60 MHz for rear panel sync.

**X-Axis drive:** 0 to  $>+10$  V dc linear ramp proportional to sweep frequency, linearity, 10-90%,  $\pm$  0.1% of final value.

### MATE/CIIL Compatibility

For MATE system applications, option H05 provides internal CIIL compatibility.

### Option 001 high stability frequency reference

**Aging rate:**  $\pm 5 \times 10^{-8}$ /week (72-h warm up);  $\pm 1 \times 10^{-7}$ /month (after 15 days continuous operation).

**Ambient stability:**  $\pm 5 \times 10^{-8}$  (0° to +55°C).

**Warm-up time:** reference will be within  $\pm 1 \times 10^{-7}$  of final value 15 minutes after turn-on for an off time of less than 24 hours.

### Option 002 high voltage output

**Frequency range:** 1  $\mu$ Hz to 1 MHz

#### Amplitude

**Range:** 4.00 mVpp to 40.00 Vpp ( $\geq 500 \mu$ ,  $\leq 500$  pF load).

**Accuracy:**  $\pm 2\%$  of full output for each range at 2 kHz.

**Output impedance:**  $< 2 \Omega$  at dc,  $< 10 \Omega$  at 1 MHz

**dc offset range:** 4 times the specified range of the standard instrument.

### General

#### Operating environment

**Temperature:** 0°C to 55°C.

**Relative humidity:** 95%, 0°C to 40°C.

**Altitude:**  $\leq 15,000$  ft.

**Power:** 100/120/220/240 V, +5%, -10%, 48 to 66 Hz; 90 VA, 120 VA with all options; 10 VA standby.

**Weight:** 9 kg (20 lb) net; 14.5 kg (32 lb) shipping.

**Size:** 132.6 H x 425.5 W x 497.8 mm D (5.25" x 16.75" x 19.63").

### Ordering Information\*

HP 3325B Frequency Synthesizer

Opt 001: High Stability Frequency Reference

Opt 002: High Voltage Output

Opt H05: Internal MATE Programming

Opt W30: Extended Repair Service. See page 723.

#### Price

\$4,620

-\$815

+\$270

(call HP)

+\$115

\*HP-IB cable not supplied.

☎ For same day shipment call HP DIRECT at 800-538-8757.

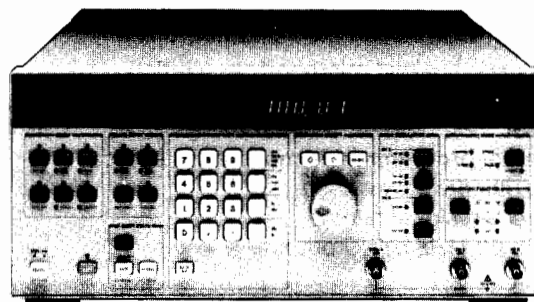

HP 3326A



### HP 3326A Two-Channel Synthesizer

The HP 3326A Two-Channel Synthesizer combines two independent synthesizers, flexible modulation and control circuitry into a single, powerful package. This single instrument provides precise phase offset, two-tone sweep, fast frequency switching, internal modulation, and pulse signals for bench or systems use.

With multiple channels and modes, the HP 3326A does the job of several sources. An internal switch selected signal combiner sums both source outputs into a single ultra-low IMD signal source. Phase continuous sweeps are available in linear and multielement discrete modes. DC offset is available in all modes, and all outputs are floating. Frequency resolution is 11 digits, with flexible triggering for frequency, amplitude and phase changes and sweeps.

#### Specifications Summary

For complete specifications, refer to the HP 3326A data sheet.

**Frequency** (waveforms are sine, square, pulse, and dc)

**Range:** 0 Hz to 13 MHz.

**Resolution:** 1  $\mu$ Hz below 100 kHz, 1 mHz at and above 100 kHz.

**Stability:**  $\pm 5 \times 10^{-6}$ /year, 20° to 30°C.

**Output amplitude** (sine mode)

**Range:** 1 mVpp to 10 Vpp in 8 ranges without DC offset.

**Accuracy:** relative to programmed value after self-calibration

	0.001 Hz	100 KHz	1 MHz	13 MHz
+23.98 dBm				
+3.98 dBm	$\pm 0.1$ dB		$\pm 0.3$ dB	$\pm 0.6$ dB
-36.02 dBm	$\pm 0.2$ dB		$\pm 0.5$ dB	$\pm 0.8$ dB
-56.02 dBm	$\pm 0.2$ dB		$\pm 0.5$ dB	$\pm 1.0$ dB

#### Phase offset

(channel A vs B in two-phase mode)

**Range/Resolution:**  $\pm 720$  degrees range, 0.01 degree resolution.

**Accuracy:** after self-calibration, for equal-level sinewaves 1 V to 10.

	0.1 Hz	10 Hz	100 kHz	1 MHz	13 MHz
	$\pm 0.5$		$\pm 0.2$	$\pm 0.3$	$\pm 2.0$

#### Frequency sweep

**Sweep types:** linear, discrete (2-63 discrete elements)

**Sweep time:** 5 ms to 1000 s, Linear or per element.

Option 001 High Stability Frequency Reference

**Stability:**  $\pm 5 \times 10^{-8}$ /week after 72 hours continuous operation.

$\pm 1 \times 10^{-7}$ /month after 15 days continuous operation.

Option 002 High Voltage Output

**Frequency range:** dc to 1 MHz

**Amplitude range:** 4 mV to 40 Vpp into  $> 1k \Omega$ ,  $< 200$  pF load.

**dc offset:**  $\pm 20$  V, independent of amplitude range. dc + ac peak must not exceed 20V.

#### General

**Power:** 100/120/220/240 V, +5%, -10%, 48 to 66 Hz; 290 VA max.

**Weight:** net, 2kg (60lb); shipping, 37kg (81lb)

**Size:** 177H x 425.5W x 497.8mmD (7" x 16 $\frac{3}{4}$ " x 19 $\frac{5}{8}$ ")

#### Ordering Information

HP 3326A Two-Channel Synthesizer

Opt 001 High Stability Frequency Reference

Opt 002 High Voltage Output

Opt 003 Rear Terminal Outputs (Rear only)

Opt W30 Extended Repair Service. See page 723.

#### Price

\$10,600

+\$690

+\$315

\$0

+\$250

# FUNCTION GENERATORS & WAVEFORM SYNTHESIZERS

## 1 MHz to 21 MHz Synthesized Function/Sweep Generator

HP 3324A

445

- Multi-interval sweeper
- Two-phase signals
- Reference source
- Function generator
- 60 MHz TTL clock

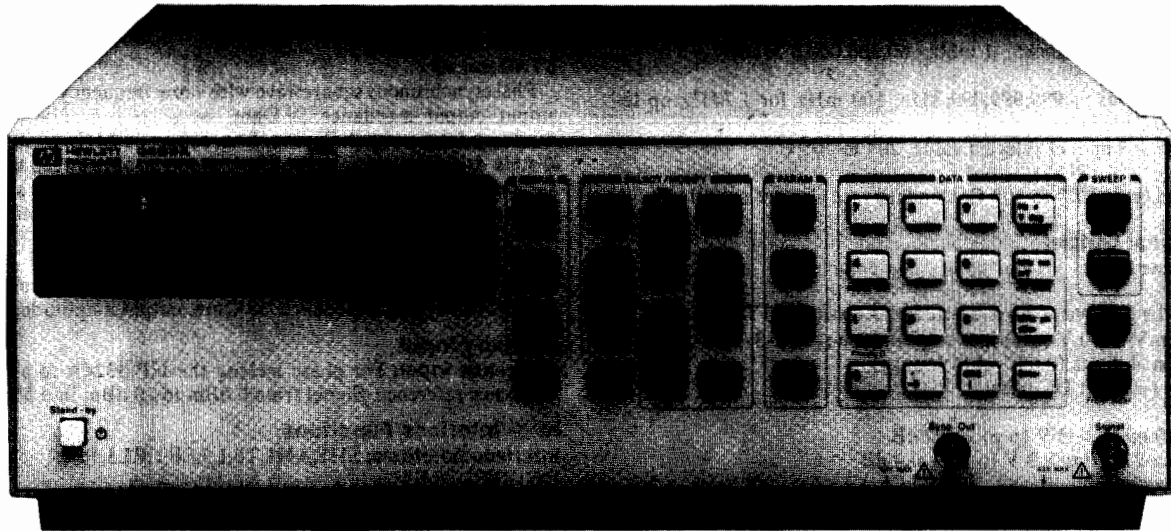

HP 3324A



### The HP 3324A Synthesized Function/Sweep Generator

The HP 3324A complements HP's family of synthesized function generators. It combines good synthesizer quality with extended sweep capabilities, at a low price.

#### Multi-Interval Sweeping

The 3324A offers the capability to define up to 50 different sweep intervals, each containing its individual sweep parameters, such as start and stop frequency, sweep time, linear or logarithmic sweep and marker frequency. Up to 100 intervals can be sequenced, because the repetition of intervals is possible.

The following example shows 4 different intervals of a sequence of 5. Interval 1 is a linear up-sweep followed by interval 2 which has the same start-frequency and stop-frequency. Interval 3 represents a logarithmic sweep; it is repeated at the end of the sequence. Interval 4 is linear down-sweep. The complete sequence is generated once in single mode or continuously in continuous mode.

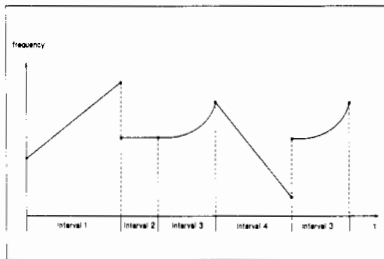

The sweep is performed phase-continuous, even if stop-frequency and start-frequency of succeeding intervals are not equal.

#### The Reference Source

Many applications, like PLL testing and calibration of measurement instruments, require a frequency reference which can be accurately tuned and which is stable over a long period of time. The accuracy and stability of the HP 3324A fulfills this requirement.

For those applications which require a better stability than 5 ppm/year, a high stability frequency reference oven provides a stability of 0.05 ppm/week (optional).

#### Good spectral purity

In addition to the highly stable frequency the HP 3324A provides good sinewave spectral purity with  $-50$  dBc phase noise and  $-55$  dBc spurious signals.

#### The clock generator (1 MHz to 60 MHz)

Complex test set-ups can be built only if a reliable clock generator minimizes jitter or timing uncertainties. The HP 3324A provides clock frequencies from 1 MHz up to 60 MHz - synthesized over the full frequency range.

#### Automatic phase calibration

Two 3324A can be used to generate phase related signals. After power-on, the phase between the two instruments is arbitrary.

Time-consuming phase adjustments can be avoided with the automatic phase calibration options. Just enter the required phase offset, and they calibrate to this value after a simple keystroke or HP-IB command.

#### High Output Voltage

If more than 10 V (p-p) amplitude is required then the High Voltage Option enhances the amplitude range up to 40 V (p-p) (limited for frequencies up to 1 MHz).

#### Structured Front Panel

The HP 3324A's front panel is clearly structured and is supported by an alphanumeric fluorescence display. The status of the instrument can be seen immediately, as all of the selected parameters and functions are displayed.

#### Waveforms

Sine, Square, Triangle, negative and positive Ramps, DC, TTL clock

#### Specifications

For complete specifications refer to the HP 3324A data sheet (Pub. No. 5952-9678).

## Frequency Range

Sine:	1 mHz - 21,000,000,0 MHz
Square:	1 mHz - 11,000,000,0 MHz
Triangle/Ramps:	1 mHz - 11,000,000,0 kHz
Auxiliary TTL clock:	1 mHz - 60,000,000,0 MHz

## Resolution

1 mHz for up to 999,999,999 kHz, 100 mHz for 1 MHz up to 21,000,000,0 MHz

**Accuracy:**  $\pm 5$  ppm of selected value, 20° to 30° C

## Stability

$\pm 5$  ppm/year, 20° to 30° C, standard (see also option 001)

## Main Signal Output

**Impedance:** 50 $\Omega$

## Amplitude (all waveforms except Auxiliary TTL clock)

**Range:** 1 mV to 10 V (p-p) in 8 amplitude ranges, 1-3-10 sequence.

**Resolution:** 4 digits (0.03% of full range)

**Accuracy** (without DC offset)

### Sine

1mHz-100kHz:  $\geq 3$  V (p-p)  $\pm 0.2$  dB

>100kHz-21MHz:  $\geq 3$  V (p-p)  $\pm 0.4$  dB

### Squarewave

1mHz-100kHz:  $\geq 3$  V (p-p)  $\pm 1.5\%$

100kHz-10MHz:  $\geq 3$  V (p-p)  $\pm 5\%$

### Triangle

1mHz-2kHz:  $\geq 3$  V (p-p)  $\pm 1.5\%$

2kHz-10kHz:  $\geq 3$  V (p-p)  $\pm 5\%$

## Sinewave Spectral Purity

### Phase Noise

- 50 dB for a 30 kHz band centered on a 20 MHz carrier (excluding  $\pm 1$  Hz about the carrier).

### Spurious

All non-harmonically related output signals will be more than 55 dB below the carrier.

### Sinewave harmonic distortion

Harmonically related signals will be less than the following levels relative to the fundamental:

Frequency Range	Harmonic Level
.1 Hz - 199 kHz	- 60 dBc
200 kHz - 1.99 MHz	- 40 dBc
2 MHz - 14.9 MHz	- 30 dBc
15 MHz - 20 MHz	- 25 dBc

## Waveform Characteristics

### Squarewave characteristics

Rise/Fall time: (10% to 90% at full output)  $= < 20$  ns

Overshoot: 5% of peak to peak amplitude at full output

### Triangle/Ramp characteristics

Linearity (10%-90%, 10 kHz):  $\pm 0.05\%$  of full p-p output voltage

## DC Offset

**Range:** dc only (no ac signal): 0 to  $\pm 5$  V/50 Ohm

**Resolution:** 4 digits

## Phase Offset

### Range

$\pm 719.9^\circ$  with respect to arbitrary starting phase or assigned zero phase. See also option 003 and 004.

**Resolution:** 0.1°

## Frequency Sweep

**Sweep sequence modes:** single, continuous

### Sweep function modes:

**Multi-Interval:** Up to 50 different intervals can be sequenced and repeated in a sequence which can contain up to 100 intervals.

**Multi-Marker:** One marker frequency can be set in each interval or up to 9 marker frequencies can be set if only one interval is used.

**Sweep time (settable for each interval):** Linear, 10 ms to 10<sup>5</sup>s. Log. 100 ms to 10<sup>5</sup>s.

**Maximum sweep width (settable for each interval):** full frequency range of the main signal output for the waveform in use, except minimum log start frequency is 1 Hz.

**Phase continuity:** sweep is phase continuous over the full frequency range of the main output.

## Auxiliary Outputs

### SYNC output

Phasesynchronous squarewave with same frequency as main signal output, output impedance: 50 Ohm

**Auxiliary freq. output:** Square, freq. range: 21 MHz to 60 MHz

**X-Axis drive output:** Linear ramp proportional to sweep time

**Z-Axis blank output:** Output signal depending on sweep state.

**Sweep marker output:** Pulses (TTL and CMOS compatible) at selected marker frequencies

### 1 MHz reference output

1 MHz squarewave for phase locking additional instruments to the HP 3324A, output impedance: 50 Ohm, output amplitude: 0 dBm.

## Auxiliary Input

**Reference input:** For phase locking the HP 3324A to an external frequency reference. Signal from 0 dBm to 20 dBm into 50 Ohm.

## HP-IB Interface Functions

**Interface functions:** SH1,AH1,T6,L3,SR1,RL1,PP0, DC1,DT0,C0,E2

## Option 001, High Stability Frequency Reference

### Aging rate

$\pm 5 \times 10^{-8}$ /week after 72 hours continuous operation.

$\pm 1 \times 10^{-7}$ /month after 15 days continuous operation.

### 10 MHz oven output

10 MHz squarewave for phaselocking additional instruments to the HP 3324A, output impedance: 50 Ohm, output level:  $> 4.5$  dBm

## Option 002, High Voltage Output

**Frequency range:** 1 mHz to 1 MHz

### Amplitude

4 mV to 40 V (p-p) in 8 ranges, 4-12-40 sequence into 500 Ohm,  $< 500$  pF load.

**Accuracy:**  $\pm 2\%$  of full output for each range at 2 kHz.

**Flatness:**  $\pm 10\%$  relative to programmed amplitude.

### Waveform characteristics

#### Sinewave harmonic distortion

Harmonically related signals will be the same as the standard instrument up to 1 MHz.

**Squarewave characteristics** (typical, 500 Ohm, 500 pF load)

Rise/Fall Time: (10% to 90% of p-p output voltage)  $\leq 125$  ns

Overshoot:  $\leq 10\%$  of p-p output voltage

**Output impedance:**  $< 3$  Ohm at dc,  $< 10$  Ohm at 1 MHz

**DC Offset:** 4 times the specified range of the standard instrument

## Options 003 and 004, Automatic Phase Calibration

These options provide automatic phase calibration if two HP 3324As are connected to generate phase related signals. Option 003 has to be installed into one of the instruments and option 004 into the other. Phase shifted signals can be achieved by selection of a certain phase offset.

## General

**Power:** 100/120/220/240 V, 48 to 66 Hz, max. 100 VA

**Weight:** 11 kg net

**Dimensions:** 132.6 mm high x 425.5 mm wide x 497.8 mm deep

## Ordering Information

	Price
HP 3324A Synthesized Function/Sweep Generator	\$3500
Opt 001 High Stability Frequency Reference	+\$765
Opt 002 High Voltage Output	+\$255
Opt 003 Automatic Phase Calibration, slave	+\$450
Opt 004 Automatic Phase Calibration, master	+\$270
Opt 907 Front Handle Kit (5062-3989)	+\$55
Opt 908 Rack Flange Kit (5062-3977)	+\$33.50
Opt 909 Rack Flange and Handle Combination Kit (5062-3983)	+\$82.50
Opt W30 Extended repair service. See page 723.	+\$90

☎ For same-day shipment, call HP DIRECT at 800-538-8787

# FUNCTION GENERATORS & WAVEFORM SYNTHESIZERS

## Synthesizer/Function Generator

HP 3335A, 3336C

447

- 200 Hz to 81 MHz
- High spectral purity
- Precision amplitude control
- 1 MHz resolution

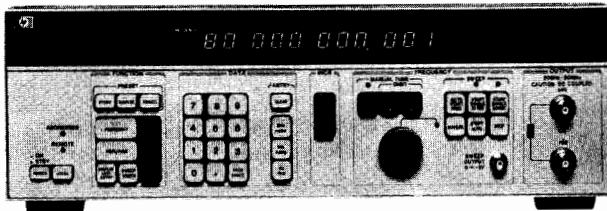

HP 3335A



### HP 3335A Synthesizer/Level Generator

The HP 3335A Synthesizer/Level Generator has performance characteristics that make it ideally suited for the telecommunications industry as well as for traditional synthesizer applications, including testing of Frequency Division Multiplex (FDM) equipment and R&D and production testing of communications systems.

#### Precision Amplitude, Frequency

The HP 3335A incorporates a state-of-the-art attenuator with accuracies of up to  $\pm 0.025$  dB over the 81 MHz frequency range. Frequency stability up to  $\pm 1 \times 10^{-8}$ /day is provided by an internal temperature-controlled oscillator.

#### Frequency Sweep, Tracking Generator

The HP 3335A combines the frequency, accuracy and stability of a synthesizer with the time-saving convenience of a digital sweeper. In addition, the HP 3335A operates as a tracking generator with the HP 3746A/B Selective Level Measuring Set (SLMS) or the HP 3586A/B/C Selective Level Meter for automatic or semi-automatic testing of FDM systems.

#### Specifications

Contact your local HP Sales Office for more information including a data sheet with complete specifications.

##### Frequency

**Standard range:** 200 Hz–81 MHz;

**Resolution:** .001 Hz.

**Option 002/004 range:** 75 $\Omega$ , 200 Hz–81 MHz; 124 $\Omega$ , 10 kHz–10MHz; 135/150 $\Omega$ , 10 kHz–2 MHz.

**Option 003 Range:** 75 $\Omega$ , 200 Hz–81 MHz; 150 $\Omega$ , 10 kHz–2 MHz.

**Option 001** (high stability frequency reference)

Stability, long term:  $\pm 1 \times 10^{-10}$ /day;  $\pm 1 \times 10^{-7}$ /month.

Aging rate:  $\pm 5 \times 10^{-8}$ /day;  $\pm 2 \times 10^{-8}$ /month.

##### Spectral purity

**Harmonic distortion:** 200 Hz–10 MHz:  $< -45$  dBc; 10 MHz–80 MHz;  $< -40$  dBc.

**Phase noise:** (30 kHz band, excluding  $\pm 1$  Hz, centered on the carrier): 9.9 MHz:  $< -63$  dBc; 20 MHz;  $< -70$  dBc; 40 MHz;  $< -64$  dBc; 80 MHz:  $< -58$  dBc.

**Spurious:** nonharmonically related signals: the greater of  $-75$  dBc or  $-125$  dBm (50/75 $\Omega$ ),  $-97$  dBm (124 $\Omega$ ),  $-68$  dBm (135/150 $\Omega$ ).

##### Amplitude range

$-88.74$  dBm to  $+13.01$  dBm depending on option and impedance.

**Resolution:** 0.01 dB.

**Absolute level accuracy** (max. output at 100 kHz, 10 $^{\circ}$ C to 35 $^{\circ}$ C): 50/75 $\Omega$   $\pm 0.05$  dB; 124/135/150 $\Omega$ :  $\pm 0.1$  dB.

**Flatness** (relative to 100 kHz, full amplitude): 50/75  $\Omega$ : 1 kHz – 25 MHz:  $\pm 0.07$  dB, 200 Hz–80 MHz:  $\pm 0.15$  dB; 124 $\Omega$ : 50 kHz–10 MHz:  $\pm 0.15$  dB, 10 kHz–10 MHz  $\pm 0.4$  dB; 135/150 $\Omega$ : 10 kHz–2 MHz:  $\pm 0.18$  dB.

#### Ordering Information

HP 3335A Synthesizer/Level Generator	Price
Opt 001 High-stability reference $\pm 5 \times 10^{-10}$ day	+\$1,270
Opt 002 Connector (75/124/135 $\Omega$ )	+\$575
Opt 003 Connector (75/150 $\Omega$ )	+\$365
Opt 004 Connector (75 $\Omega$ , miniature WECO on 124/135 $\Omega$ )	+\$575
Opt C01 Rack Slide Mount	Contact HP

- 10 Hz to 20.999 MHz
- 11 digit resolution
- Excellent amplitude accuracy
- 1 MHz resolution

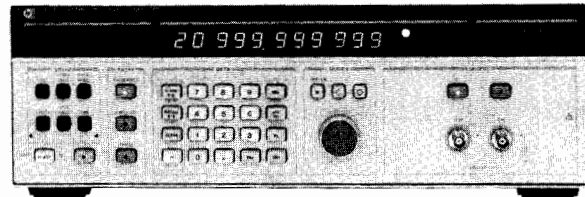

HP 3336C



### HP 3336C Synthesizer/Function Generator

The HP 3336C is designed for traditional synthesizer applications as well as R&D and production testing of systems or components. It features precision level control, high spectral purity, optional frequency stability of  $\pm 5 \times 10^{-8}$ /week, internal frequency sweep and numerous other user conveniences.

#### Precision Frequency Measurements, Amplitude Accuracy

A single loop fractional-N synthesis technique allows synthesizer accuracy with 11 digits of resolution, with completely phase continuous frequency sweep over any of the instruments' frequency ranges. HP attenuator technology coupled with custom designs in leveling loops and thermal converters produce amplitude accuracies of up to  $\pm 0.05$  dB. The fast leveling loop makes extremely flat sweeps possible at high sweep speeds.

Models HP 3336 A & B are also available for the telecommunications industry (see page 554).

#### Specifications

Contact your local HP Sales Office for more information including a data sheet with complete specifications.

##### Frequency

**Range:** 10 Hz to 20.999 999 999 MHz.

**Resolution:** 1 $\mu$ Hz for frequencies  $< 100$  kHz, 1 MHz for frequencies  $\geq 100$  kHz.

**Aging rate:**  $\pm 5 \times 10^{-6}$ /year (20 $^{\circ}$  to 30 $^{\circ}$ C).

##### Amplitude

**Range:** 50 $\Omega$ :  $-71.23$  to  $+8.76$  dBm; 75 $\Omega$ :  $-72.99$  to 7.00 dBm.

**Absolute accuracy:**  $\pm 0.05$  dB, 20 $^{\circ}$  to 30 $^{\circ}$ C (for the top 9.99 dB of amplitude range at 10 kHz),  $\pm 0.08$  dB, 0 $^{\circ}$  to 55 $^{\circ}$ C.

**Flatness:** 50/75 $\Omega$ ,  $\pm 0.1$  dB ( $\pm 0.07$  dB with option 005) referenced to 10 kHz.

##### Amplitude modulation

**Modulation depth:** 0 to 100%.

**Modulation frequency range:** 50 Hz to 50 kHz.

##### Phase modulation

**Range:** 0 $^{\circ}$  to  $\pm 850^{\circ}$ .

**Linearity:**  $\pm 0.5\%$  from best fit straight line.

**Modulation frequency range:** dc to 5 kHz.

##### Frequency sweep

Sweep time: Linear; 0.01 s to 99.99 s. Single Log: 2 s to 99.99 s.

Continuous Log: 0.1 s to 99.99 s.

##### Dimensions

Size: 132.6H x 425.5W x 497.8mmD (5.2" x 16.8" x 19.6").

Weight: net, 10 kg. (22 lb); shipping, 15.5 kg. (34 lb).

#### Ordering Information

HP 3336C Synthesizer/Level Generator	Price
Opt 004 High Stability Frequency Reference	+\$685
Opt 005 High Accuracy Attenuator	+\$685
Opt 907 Front Handle Kit	+\$58
Opt 908 Rack Flange Kit	+\$34
Opt 909 Rack Flange and Handle Kit	+\$84
Opt W30 Extended Repair Service. See page 723.	+\$130

# PULSE GENERATORS & DATA GENERATORS

## General Information



Typical stimulus-response test setup. The HP 8131A pulse generator in the foreground generates 500 MHz pulses with typically 120 ps transitions (20 to 80% of amplitude). The HP 54120 series oscilloscope measures device response.

### Stimulus Selection Guide

Application	Advanced IC development				General electronic evaluation					Digital - communications - radar - automotive					
Stimulus type	Fast pulse generators				General-purpose pulse generators					Data generators		Arbitrary	Pulse/function generators		
HP Model	8131A	8130A	8082A	8161A MATE option	8160A MATE option	214B High-voltage	8012B	8112A	8115A	8118A Pulse patterns	8175A Data patterns and arbitrary waveforms	8175A#002	8111A	8116A	8165A
Special features															
Page	450	452	456	454	454	458	459	460	461	462	464	438	437	440	442
<b>Timing</b>															
Max rate (MHz/Mbit/s)	500	300	250	100	50	10	50	50	50	50 (RZ) 100 (NRZ)	50 (NRZ)	50 M samples/s	20	50	50
Min transition time (ns)	0.2	1	1	1.3	6	15 fixed	5	5	6.5	6.5	See pod specs	12	10	6	5
Variable delay	•	•	•	•	•	•	•	•	•	•	Opt 001				
Min width (ns)	0.5	1	2	4	10	25	10	10	10	10	20	20	25	10	20% duty
Best resolution (ns)	0.01	0.01		0.1	0.1			0.1	0.1	0.1	10	10	0.1	0.1	1 mHz
<b>Outputs</b>															
Channels	2 (Opt)	2 (Opt)	1	2 (Opt)	2 (Opt)	1	1	1	2	2	24	2	1	1	1
Vpp into 50 Ω	5	5	5	5	20	100	5	16	16	16	See pod specs	16	16	16	20
Best resolution (mV)	10	10		10	10			10	10	10		0.2	0.1	0.1	0.1
Vwindow into 50 Ω	±5	±5	±5	±5	±20	0/100	±2.5	±8	±8	±8		±8	±8	±8	±10
Normal/complement	Both	Both	Both	Select.	Select.	Pos/neg	Select.	Select.	Select.	Select.	Normal	Select.	Select.	Select.	Select.
<b>Modes</b>															
Trigger gate modes	•	•	•	•	•	•	•	•	•	•	•	•	•	•	•
Burst mode	•	•		•	•	Opt 001		•	•	•	Memory	Memory	Memory	Opt 001	•
Modulation/control											High-level	Algorithm	VCO	•	•
Sweep	Shaper											Algorithm		Option	Option
<b>Waveforms</b>															
Pulse, square	•	•	•	•	•	•	•	•	•	•	•	•	•	•	•
Ramp, triangle		•	•	•	•	•	•	•	•	•		•	•	•	•
Sine, Gauss pulses												•	•	•	•
Multi-level												•			•
<b>Data patterns</b>															
Depth (kbit)											16	1	1		
Segments/ loops/ jumps											1//	255/255/2	255/255/2		
<b>Programmability</b>															
HP-IB	•	•		CIIL/•	CIIL/•			•	•	•	•	•		•	•
HP ITG driver available	•	•						•					•		
<b>Suggested oscilloscope or logic analyzer</b>															
	HP54120	HP54120	HP54120	HP54110D	HP54110D	HP54501A	HP54503A	HP54503A	HP54503A	HP16530A	HP16510B	HP16530A	HP54501A	HP54503A	HP54503A
										HP1653B	HP1651B	HP1653B			



**Compact HP Solutions**

Verify your design under real conditions with HP stimulus-response setups. With programmable sources and instruments, you achieve resolution and accuracy for repeatable measurements. When you add the statistical and documentation possibilities of digitizing oscilloscopes, you turn measurements into credible results.

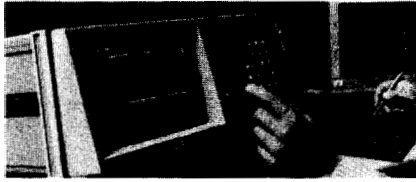

**Digital IC Test**

Trigger levels, timing and output drive, for example, can be measured using an HP 54503A oscilloscope and an HP 8112A pulse generator. Source resolution is 100 ps/10 mV and the measurement accuracy is 1.5% voltage and 50 ps timing. For dynamic devices, dual-channel sources are available.

**Analog and Digital VLSI and Boards**

Serial data devices can be function- and parametric-tested by the HP 8118A pulse patterns. Parallel data is the domain of the HP 8175A which tests interactively, and can

create arbitrary waveforms at the same time. Combining these with the HP 165x or 165xx logic analyzer/oscilloscopes makes universal testing for analog, digital and mixed circuits an economic reality.

**High-speed Characterization**

The HP 813x pulse generators provide nano- and subnano-second edges which can be positioned in 10 ps steps. Together with the GHz bandwidths of the HP 54120 series oscilloscopes, they address some of today's fastest logic. These features are discussed in application note AN 381 (GaAs flip-flop test), and application note AN 381-1 (200 MHz Schmitt trigger test).

**IC test head, computer backplanes**

The HP 8131A with sub-nanosecond filter accessories provides a very smooth calibration pulse, and the HP 8130As variable transitions are ideal for bandwidth and crosstalk tests.

**LAN Devices**

The HP 8118A can generate any 2-, 3- or 4-level code, has plenty of memory for super-messages, variable parameters for waveform mask, and can drive lines direct.

**Automotive Applications**

Magnetic sensor pulses can be simulated by several pulse and pulse/function generators with external rate modulation. The

HP 8175A arbitrary waveform option allows the signal to be entered as an algorithm, and can also emulate tachometer signals. Complex tachometer profiles can be simulated by the HP 3324As segmented sweep (previous section).

**Radar Baseband Signals, Sonar**

Delayed pulse bursts, amplitude, and frequency modulated pulse trains are among the very individual signals that pulse and pulse/function generators can generate. Complex bursts can be managed by data sources. Modulation can be real-time on the HP 8118A, or created with the HP 8175A arbitrary waveform.

**Physical Research**

As examples, scintillator signals can be simulated by pseudo-random data, and bio and mechanical signals by loading either algorithms or a digitized oscilloscope captures to the HP 8175A.

**Analog Circuits and Components**

Measurements such as amplifier bandwidth, filter performance, servo step response, and diode reverse recovery time are performed quickest using rectangles or trapezoids from the HP 8112A. For spike immunity or stressing, the HP 214B generates 100 V pulses. Programmable filters, DACs and ADCs can obtain input and control or compare signals simultaneously from the HP 8175A.

**Pulse Parameter Definitions of Terms Used in Instrument Specifications**

**Time Reference Point:** Median (50% amplitude point on pulse edge).

**Pulse Period:** The time interval between the leading edge medians of consecutive trigger output pulses.

**Trigger Delay:** Interval between trigger point of input signal and the trigger output pulse's leading edge median. Applies in trigger, external width, gate and burst modes.

**Pulse Delay:** Interval between leading edge medians of trigger output pulse and output pulse.

**Double Pulse:** Interval between leading edge medians of the double pulse.

**Interchannel Delay/Skew:** Interval between corresponding leading edge medians.

**Pulse Width:** Interval between leading- and trailing-edge medians.

**Additional Information for Pulse Generators with Variable Transition Times**

**Pulse Width:** The specified and displayed value is that obtained with fastest edges; essentially equal to the interval from the start of the leading edge to the start of the trailing edge.

By designing so that the pulse edges turn about their start points, the interval from leading edge start to trailing edge start stays unchanged\* when transition times are varied. This is more convenient for programming and the width display is easy to interpret.

\*In practice, start points may shift with change in transition time.

**Delay:** The specified and displayed value is that obtained with the fastest leading edge. For a slower edge, the actual delay exceeds the displayed delay by the combined shift of start-point end median.

**Transition Time:** Interval between the 10% and 90%-amplitude points on the leading/trailing edge.

**Linearity:** Peak deviation of an edge from a straight line through the 10% and 90%-amplitude points, expressed as percentage of pulse amplitude.

**Period:** Interval between consecutive pulses.

**Delay:** Interval between trigger and pulse.

**Period Jitter:** Variation in pulse period.

**Width Jitter:** Variation in pulse width.

**Amplitude:** (alternative to level definition): Pulse amplitude and offset\* are specified. Any limitation is expressed by a window (max high level, min low level).

\*Pulse generators use baseline offset. Function generator outputs are symmetrical and consequently use median offset.

**Overshoot/undershoot <math>\leq 5\%</math>**

**Largest pulse-top oscillation <math>\leq \pm 5\%</math>** of pulse amplitude.

**Settling Time:** Time taken for pulse levels to settle within level specification, measured from 90% point on leading edge.

**Duty Cycle:** Percentage ratio of pulse width to period. In pulse/function generators, this term is also used to define sine and triangle symmetry.

**Output Impedance/Resistance:** Effective pulse source impedance/dc resistance.

**Reflection Coefficient:** Reflection at pulse generator output expressed in percent of incident pulse amplitude. (Test pulse edges correspond to generator's fastest transitions).

**Repeatability:** When an instrument operates under the same environmental conditions, and with the same settings, the value of a parameter will lie within a band inside the accuracy window. Repeatability defines the width of this band.

**HP-IB Programming Times**

**Listen Time:** The time an instrument occupies the bus to receive and verify a message. The NRFD signal is active during this period.

**Settling Time:** The time taken by the instrument to execute an HP-IB message, and for the output to settle within the accuracy specification. NRFD inactive.

**Execution Time:** The sum of Listen Time and Settling Time.

**Talk Time:** The time an instrument occupies the bus to output a specified string. Output data is typically instrument error status, or current or stored parameters.

# PULSE GENERATORS & DATA GENERATORS

## 500 MHz High-speed Pulse Generator

HP 8131A

- <200 ps fixed transitions
- suitable for BICMOS, ECL, and GaAs technologies
- 10 ps 10 mV best case resolution
- optional second channel
- simulates data/clock signals
- 1 GHz Transducer Mode

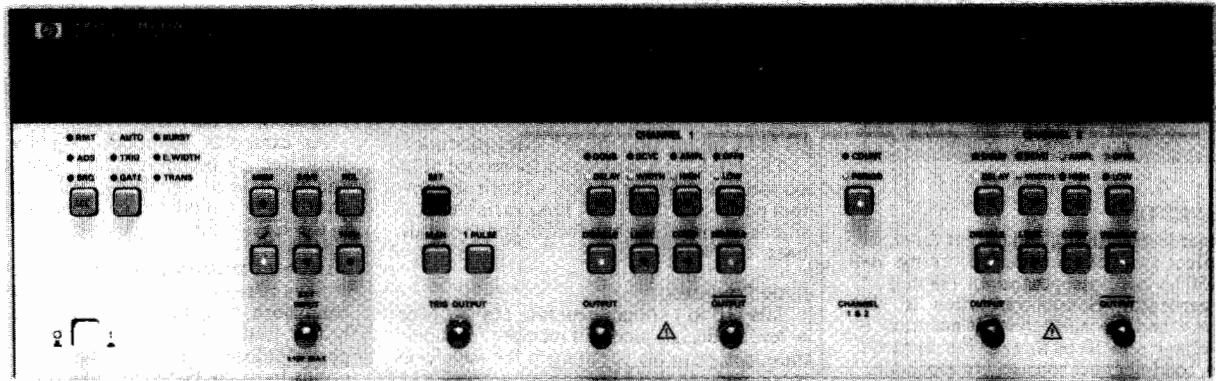

HP 8131A with Option 020, second channel



### 200 ps Transition Times

The HP 8131A delivers excellent performance to help you solve high-speed measurement problems. Transition times of less than 200 ps from the 10% to 90% amplitude (20% to 80% of amplitude; typical 150 ps) enable repeatable and reliable timing measurements on high speed digital circuits. Since compromises in edge speed directly affect your measurement accuracy, the clean and sharp edges offered by the HP 8131A minimize errors due to threshold uncertainties. Matching the requirements of the most advanced ECL and GaAs devices, you now can characterize components and circuits with repetition rates up to 500 MHz (in Transducer Mode up to 1 GHz). The HP 8131A is the first product that offers 200 ps edge speed in a fully programmable product which makes it extremely useful not only in R&D environments but also in high speed production test applications.

### 10 ps Timing Resolution

The high timing resolution allows precise measurement of timing parameters like setup and hold times. Especially in the two channel version, the ability to exactly position sharp pulses through independent delay and width makes the HP 8131A a very useful tool in evaluating fast digital circuits. With a timing resolution that is about one order of magnitude higher than the typical gate delay of ECL devices, it is easy to detect trends when varying a critical pulse parameter without losing a required timing relation. Spikes can be simulated with 500 ps small pulses, and in combination with the 10 ps width resolution, timing and energy related failures can be examined.

### 5V Amplitude and 10 mV Resolution

The 5V amplitude makes it possible to stimulate high speed circuits such as ECL, GaAs, or BICMOS devices. In addition, you now can test the excess-voltage immunity of your high speed components and evaluate crosstalk caused by 5 V, 200 ps transitions. The 10 mV resolution helps to slowly approach the threshold levels of digital circuits. The minimum amplitude of 100 mV is enough to check for minimum signal swing up to a 500 MHz (1 GHz in Transducer Mode) repetition rate. In combination with the full programmability, you now can do detailed analysis of critical level conditions in an automated test routine.

### 500 MHz Repetition Rate

The 500 MHz repetition rate of the HP 8131A establishes a new class of high speed programmable pulse generator, which allows testing at the maximum toggle rate of your ECL, CMOS and complex GaAs devices. Now it is possible to perform functional and parametric tests of fast digital circuits under program control. In R&D, this means more reliable tests under repeatable conditions and easy documentation of test results. In production, the programmability opens new possibilities to functionally test high speed digital components with significantly higher throughput under well defined conditions. For the first time, the HP 8131A can test digital components at rated speed, thus increasing your confidence in the performance of your device and ensuring high quality of your product.

### 1 GHz Transducer Mode

If you need to functionally test your component at frequencies beyond 500 MHz, the 1 GHz transducer mode allows to shape an externally provided sinewave into a squarewave with transition times of 200 ps. Especially if you need a very fast, programmable clock source, the combination of the HP 8131A and a microwave signal generator is ideal. This way, you can test maximum toggle frequency with a true digital 1 GHz signal.



## Transition Time Converters (HP 15432/3/4A)

HP 8131A's fast edges are ideal for testing some of today's fastest digital ICs. But what happens when a practical circuit - through unavoidably long ground connections, for example - is reactive?

It doesn't take much inductance to cause violent ringing when shot at with edges faster than 200 ps. It's unlikely that a reduction in repetition rate will improve circuit performance unless it is accompanied by an increase in switching time, but the transition time converter satisfy the need for slower edges.

### Flexibility

You can test not only today's fastest digital ICs, but also those that need slower transition times and less overshoot and ringing.

At high frequencies, the quality of cables, connectors, and terminations can influence the transition times significantly. Always think of the route from the HP 8131A to the device as a transmission line, and the transition time converter as simply a filter that removes some of the highest frequencies, slowing the edges, damping reflections, and reducing overshoot and ringing.

### Typical Performance Characteristics:

	15432A	15433A	15434A
Output Transition Times	300 ps	500 ps	1000 ps
Intrinsic Transition Times	260 ps	480 ps	990 ps
3 dB Corner Frequency	1120 MHz	660 MHz	330 MHz
Input Voltage	< 10.0 V peak-to-peak		
Insertion Loss	< 0.2 dB		
Overshoot and Ringing	< 5%		
VSWR	< 2.0		

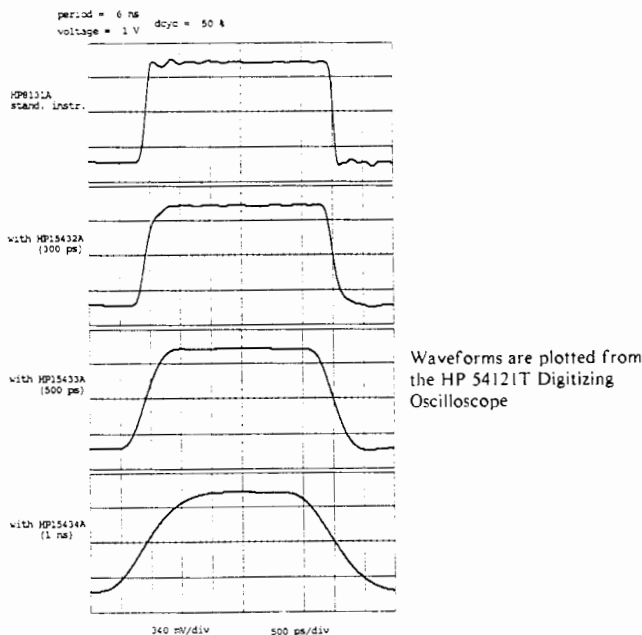

### Specifications

Specifications describe the instrument's warranted performance (30 minutes warm-up, 50-Ohm load) at 0°C to 55°C ambient temperature.

#### Timing Parameters (measured at 50% of amplitude)

##### Common Specification

Resolution: 3 digits (best case: 10 ps)

Period: 2 ns to 99.9 ms

##### Delay

Fixed: 20 ns

Variable Range: from 0 ns to 99.9 ms (max < Period) measured between trigger out and main out.

Double Pulse: 2 ns to 99.9 ms (period ≥ 5.00 ns)

Double Pulse and Delay are mutually exclusive.

Width: 500 ps to 99.9 ms (max < Period)

Transition Times: (for leading and trailing edges)

10%-90% of amplitude: < 200 ps, 300mV to 3V range

20%-80% of amplitude: < 200 ps, 100mV to 5V range

### Differential outputs

**Output Levels:** (into 50 Ω, output levels double when driving into open circuits, instrument disables outputs if levels exceed ±6.5V, or ampl. exceeds 6.5V)

**High Level:** -4.90V to +5.00V

**Low Level:** -5.00V to +4.90V

Resolution: 3 digits (best case: 10 mV)

Settling Time: 10 ns

### Operating Characteristics

(values describe typical, non-warranted performance)

#### Inputs and Outputs

**External Input:** (Trigger, Gate, Burst, Ext. Width)

Trigger slopes can be selected pos/neg.

Input impedance: 50 Ohm ±2.5 Ohm

Threshold: -5 V to +5 V

Input Frequency: dc to 500 MHz

Min. pulse width: 1 ns

Input sensitivity: ≥ 300 mV (p-p)

#### Transducer Input:

Input Impedance: 50 Ohm ±2.5 Ohm

Input transition: < 50 ns.

Input Frequency: 10 MHz to 1 GHz

Input sensitivity: ≥ 600 mV (p-p)

#### Trigger Output:

Levels: high 0V, Low -0.6 V

Delay from external input to trigger output: 16 ns

source impedance: 50 Ohm ±5 Ohm

### HP-IB Capabilities

All modes and parameters are fully HP-IB programmable.

### Operating Modes

**Manual:** Simulates an external input signal

**1 Pulse:** in Trigger, Gate and Burst mode one pulse or double pulse is generated.

**Auto:** Continuous pulse stream

**Trigger:** Each active input transition generates a single output pulse or double pulse.

**Gate:** External signal enables period generation. First output pulse synchronous with active edge. Last pulse always completed. Width and period of first pulse may deviate from subsequent pulses.

**E. Width:** Restoration of external signal with selectable output levels

**E. Burst:** Each active input transition generates a preprogrammed number of pulses (1 to 9999), min burst period is 5 ns. Width and period of first pulse may deviate from subsequent pulses.

**Transducer:** External sinewave (up to 1 GHz) toggles output. Output levels are selectable

**Limit:** Max. high and low levels into 50 Ohm can be limited to protect the device under test. Pushing the limit key declares present levels as limits which then can not be exceeded as long as the mode is active.

**Complement:** Normal/complement selectable

**Disable:** Relays connect/disconnect outputs

**Set:** Sets parameters to fixed ratio relative to period.

**Store:** Stores complete setting in displayed location

**Recall:** Recalls complete setting from displayed location.

### General

**Storage Temperature:** -40°C to +65°C

**Operating Temperature:** 0°C to 55°C

**Power:** 100/120/220/240 Vrms, ±10%, 400 VA max., 48-66 Hz

**Weight:** 20 kg (44.4 lb)

**Sizes:** 145 H x 426 W x 525 mm D,

(5.7" x 16.75" x 20.65")

**Recalibration Period:** 1 year recommended

### Ordering Information

**HP 8131A 500 MHz Pulse Generator**

**Price**  
\$14,800

#### Options

Opt 001 Rear Panel Connectors

\$0

Opt 020 Second channel (not retrofittable)

\$7,650

Opt 908 Rackmount Flange Kit (P/N 5062-3977)

\$36

Opt 916 Additional Operating and Programming Manual (P/N 08131-90011)

\$32

Opt H01 Preparation for rack slides (requires rack slide kit)

\$0

Opt W30 Extended repair service. See page 723.

\$360

#### Accessories

HP 15432A 300 ps Transition Time Converter

\$240

HP 15433A 500 ps Transition Time Converter

\$240

HP 15434A 1 ns Transition Time Converter

\$240

HP 8493A Option 010; 10 dB Attenuator

\$120

HP 8493A Option 020; 20dB Attenuator

\$120

P/N 8120-4948 Cable, Coax (SMA)

\$210

☎ For same-day shipment, call HP DIRECT at 800-538-8787

# PULSE GENERATORS & DATA GENERATORS

## 300 MHz Pulse Generator, Variable Transitions

HP 8130A

- 1 ns variable transitions
- 300 MHz repetition rate
- 5V p-p amplitude

- Minimum resolution: 10 ps; 10 mV
- 1 channel (2 optional)
- fully HP-IB programmable

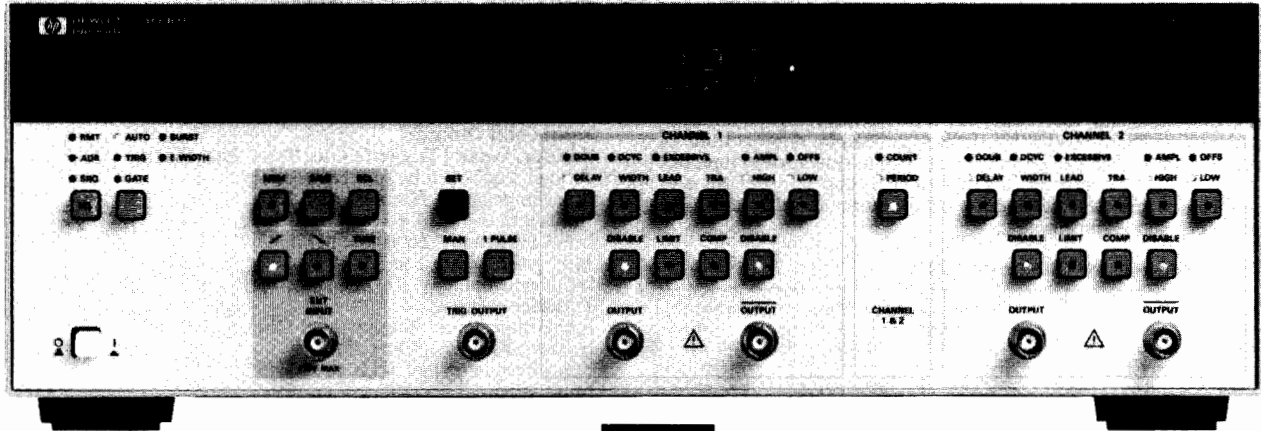

HP 8130A with Option 020, second channel



### 300 MHz Pulse Generator

The 300 MHz repetition rate of the HP 8130A Pulse Generator establishes a new class of high-speed programmable pulse generator with variable transition times. In many cases, the HP 8130A will perform parametric and function tests up to 300 MHz, because delay and width have a degree of adjustment at this speed. This increases your confidence in the device, because measurements can be performed at a higher speed and even at-speed measurements are feasible.

### Variable Transition Times

Clean edges down to 1 ns mean repeatable, reliable measurements on fast digital ICs like BiCMOS, ECL and ECLips\*. Variable transition times mean you can optimize switching speed and thus reduce the effects of ringing and reflection when driving reactive or unmatched loads. In addition, the variable transitions open a wide range of analog and digital applications, such as measuring operational amplifiers slew rate, or comparator threshold uncertainty, because trapezoidal and triangular waveforms can be generated.

### 5V p-p Amplitude and 10 mV Resolution

With 5 V p-p pulse amplitude into 50 ohms, you can cover the level requirements of all high-speed semiconductor technologies like BiCMOS, ECL, and ECLips. Minimum signal sensitivity down to 100 mV can be tested using a direct connection to the HP 8130A. Attenuators can be inserted for smaller signal amplitudes; e.g., with a 20 dB attenuator, the minimum amplitude is 10 mV with 1 mV resolution.

### 10 ps Timing Resolution

A timing resolution of an order of magnitude higher than typical gate-delays eliminates time-window uncertainties, making more accurate and reliable measurements possible.

### Data and Clock Simulation

Two signals—data and clock—are needed in order to characterize flip-flops. The HP 8130A with Option 020, second channel, is a convenient way of generating two different but synchronized signals. Double-pulse can be selected in one channel to simulate a clock, the other channel then appears to produce a series of binary ones and

zeros in NRZ (non-return-to-zero) format. Data rates up to 280 Mbit/s can be simulated.

### Rapid ATE Integration

The HP 8130A is the first fully programmable product to offer full pulse performance flexibility up to 300 MHz. Even the input trigger level can be programmed to automate your measurements. This makes it an extremely useful instrument not only for R&D and production engineering environments, but also in incoming component inspection, and for high-speed functional test applications in production test. A new standardized programming language (HP-SL) enables you to program, upload, and down-load new parameters or complete settings for future requirements; i.e., you can rapidly acquire set-ups you have previously set manually.

### Fast and Convenient Manual Operation

The proven design of Hewlett-Packard's pulse generators has been adapted to the requirements of the HP 8130A. This reduces your training, and lets you concentrate on your measurement task.

### Specifications

Specifications describe the warranted performance. Non-warranted values are described as "typical". All specifications apply after a 30 minute warm-up phase with 50 ohms load resistance at all outputs, and are valid at 0°C to 55°C ambient temperature.

#### Timing Parameters

##### Common Specifications

**Measurement conditions:** normal mode, measured at 50% of amplitude and fastest transitions.

**Resolution:** 3 digits, best case: 10 ps

##### Period

**Range:** 3.33 ns to 99.9 ms

##### Width

**Range:** 1.5 ns to 99.9 ms (max < Period)

\*registered trade mark of Motorola Inc.

**Delay**

(measured between trigger out and main out)

**Fixed delay** 18 ns

**Variable range:** from 0 ns to 99.9 ms (max < Period)

**Double pulse** (period  $\geq 7.20$  ns)

**Range:** 3.33 ns to 99.9 ms (max < Period). Double pulse and delay are mutually exclusive.

**Transition Times** (measured at 10% to 90% of amplitude)

**Range:** 1 ns to 100  $\mu$ s

**Linearity:**

transitions 1.00 ns to 1.99 ns:  $\leq \pm 20\%$  of amplitude

transitions 2.00 ns to 49.9 ns:  $\leq \pm 10\%$  of amplitude

transitions >50 ns:  $\leq \pm 3\%$  of amplitude

**Under-Programmability**

Period, width and transitions are under-programmable to ensure that the specified minimum values can always be obtained.

**Output Levels**

Output levels double when driving into open circuits. Instrument disables outputs if levels exceed  $\pm 6.5$  V, or amplitude exceeds 6.5 V p-p.

**High level:**  $-4.90$  V to  $+5.00$  V

**Low level:**  $-5.00$  V to  $+4.90$  V

**Resolution:** 3 digits, best case: 10 mV

**Level accuracy:**  $\pm 1\%$  of programmed value  $\pm 3\%$  of amplitude  $\pm 40$  mV

**Settling time:** 20 ns (at fastest transition time)

**Operating Characteristics**

Operating Characteristics describe typical, non-warranted performance.

**Duty cycle**

(Width and duty cycle are mutually exclusive)

**Range:** 1% to 90%

**Resolution:** 1%

Subject to width and period specifications

**Input and output**

BNC connectors on the front panel. Rear panel connectors are optional.

**Main outputs (differential outputs)**

**Amplitude:** 100 mV p-p to 5 V p-p into 50  $\Omega$

**Offset:**  $-4.95$  V to  $4.95$  V into 50  $\Omega$

**Source impedance:** 50  $\Omega \pm 1 \Omega$

**Maximum external voltage:**  $\pm 5$  V

**Short circuit current:** 200 mA

**External input**

Trigger, Gate, Burst, and External width mode

Trigger slopes can be selected positive or negative.

**Input impedance:** 50  $\Omega \pm 2.5 \Omega$

**Threshold:**  $-5$  V to  $+5$  V

**Resolution:** 100 mV

**Maximum input voltage:**  $\pm 10$  V

**Input transition:** <50 ns

**Input frequency:** dc to 300 MHz

**Minimum pulse width:** 1.5 ns

**Input sensitivity:**  $\geq 300$  mV p-p

**Trigger output**

**Levels:** high at 2.4 V, low at 0.3 V into 50  $\Omega$

**Trigger pulse width:**

**Period (PER)**

3.33 ns to 99.9 ns

100 ns to 999 ns

1.00  $\mu$ s to 9.99  $\mu$ s

10.0  $\mu$ s to 99.9 ms

**Pulse width**

50% of PER

95% of PER

99.5% of PER

99.95% of PER

**Transition times:** <1 ns

**Source impedance:** 50  $\Omega \pm 2.5 \Omega$

**Delay from external input or trigger output:**

**In Trigger and External Width mode:** 16 ns

**In Gate and Burst mode:** 18.5 ns

**Max/Min external voltage:**  $+7/-2$  V

**Operating Modes**

**Manual:** simulates an external input signal.

**1 Pulse:** in Trigger, Gate and Burst mode, one pulse to double pulse is generated.

**Auto:** continuous pulse stream

**Trigger:** each active input transition generates a single output pulse or double pulse.

**Gate:** external signal enables period generator. First output pulse synchronous with active edge. Last pulse always completed. Width and period of first pulse may deviate from subsequent pulses.

**External burst:** each active input transition generates a preprogrammed number of pulses (1 to 9999), minimum burst period is 5 ns. Width and period of first pulse may deviate from subsequent pulses.

**External width:** pulse recovery (external edges toggle output). Output levels and transition times are selectable.

**Limit:** maximum high and low levels into 50  $\Omega$  can be limited to protect the device under test. Pushing the limit key declares present levels as limits which then cannot be exceeded as long as the mode is active.

**Complement:** normal/complement is selectable per output

**Disable:** relays connect/disconnect outputs.

**Set:** sets parameters to fixed ratio relative to period (delay = 0 ns, width = 50% of period, transitions = 10% of period, limited to min 1 ns; period, high level and low level = current values).

**HP-IB capabilities**

All modes and parameters are programmable, downloadable and uploadable. ASCII and binary formats are supported.

**Non-volatile Memory**

Current settings are saved on power-down. Additionally, 19 complete set-ups can be stored.

**General**

**Storage temperature:**  $-40^\circ\text{C}$  to  $+65^\circ\text{C}$

**Operating temperature:**  $0^\circ\text{C}$  to  $55^\circ\text{C}$

**Power:** 100/120/220/240 Vrms,  $\pm 10\%$ , 250 VA max, 50-60 Hz

**Weight:** 20 kg (44.4 lb)

**Size:** 145H x 426W x 525mmD

(5.7" x 16.75" x 20.65")

**Recalibration period:** 1 year recommended

**Ordering Information**

HP 8130A 300 MHz Pulse Generator

**Price**

\$12,100

Opt 001 Rear Panel Connectors

\$0

Opt 020 Second Channel (not retrofittable)

\$6,300

Opt 908 Rackmount Flange Kit (P/N 5062-3977)

\$36

Opt 916 Additional Operating/Programming Manual (P/N 08130-90011)

\$32

Opt W30 Extended Repair Service. See page 723.

\$360

Opt H01 Preparation for rack slides

\$0

(rack slide kit required)

Accessories



HP 15104A/15115A



HP 15116A

HP 15104A Pulse Adder/Splitter dc to 2 GHz

\$120

HP 15116A Pulse Inverter 3 MHz to 2 GHz

\$230

HP 15115A Pulse Splitter/Inverter 3 MHz to 2 GHz

\$230

☎ For same-day shipment, call HP DIRECT at 800-538-8787.

# PULSE GENERATORS

## MATE-approved Stimuli

HP 8160A, 8161A

- HP 8160A: 6 ns variable edges/20 V pp
- Hp 8161A: 1.3 ns variable edges/5 V pp
- 1-3% basic accuracy

The HP 8160A and 8161A are fully programmable pulse generators designed for high performance applications on the bench and in automatic test systems. Operation is made easy because the pulse parameters are controlled independently and do not inter-react. Dual channel options permit synchronous or complex waveforms to be generated. With its 50 MHz repetition rate, 20 V output, and 6 ns variable transition times, the HP 8160A is a general-purpose pulse generator. The HP 8161A covers the high end of technology with its 100 MHz, 5 V, and 1.3 ns variable transition times. Measured between the 20% to 80% amplitude points, these transitions are faster than 1 ns and meet ECL requirements.

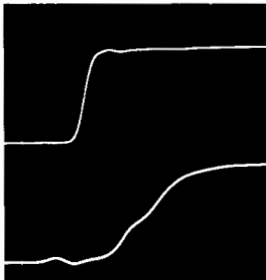

HP 8161A output

ECL memory output

Combining high programming accuracy with microprocessor-based control capabilities, pulses can be set up without a measuring instrument. Pulse parameters are entered and displayed numerically, and generated with a basic timing accuracy of 1-3%, depending upon parameter.

An easy-to-use HP-IB interface brings high-accuracy pulses to automatic test. All parameters and operating modes are remotely programmable using straight-forward command sequences. Faster, easier program generation and reduced software costs are direct benefits.

### Precision Pulse Generation

Both models provide precision control over all parameters of their output pulses. The HP 8160As leading and trailing edge transition times may be independently programmed down to 6 ns. The HP 8161As transitions have a common control from 1.3 ns to 5 ns, and are independent above 5 ns. Variable transition times are indispensable when digital ICs need to be characterized: either the ICs data sheeted input transition time is required, or the ICs functioning range with various transitions needs to be evaluated.

Direct entry of the high and low levels of the output pulse enables easy adjustment to the logic levels concerned. Pulse width is variable from 4 ns (HP 8161A) or 10 ns (HP 8160A) to 1 s, giving a wide range of duty cycle programmability. Delay shifts the output pulse in relation to the trigger output or, in double pulse mode, defines the pulse spacing.

In the dual-channel versions, double pulse can be selected in either or both channels. This means, for example, that simultaneous clock and data signals can be generated.

### Counted Burst

Using Burst Mode, a predetermined number of pulses is generated independent of frequency. Bursts from 0 to 9999 pulses in length may be produced, and can be triggered via an external signal manually or with an HP-IB command.

- Variable transitions
- Dual channel (Option 020)

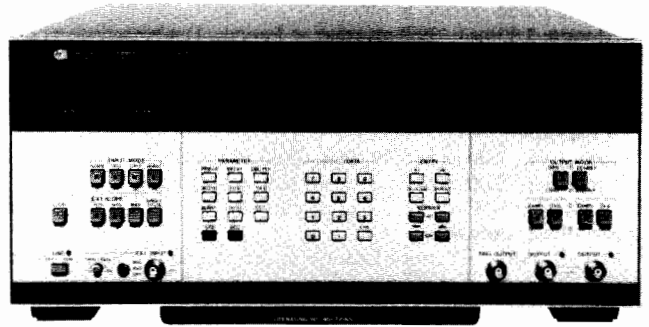

DESIGNED FOR  
MATE  
SYSTEMS

HP 8160 with options 020, 700



### Complex Signals

Independent pulse parameters plus individual programmability of the Option 020s dual outputs are augmented by the A ADD B mode. Summation allows complex signals to be precisely and easily set up. Here are some examples:

Applications such as radar coincidence circuits and special codes in communications require 3- and 4-level signals. These are conveniently generated by combining channel A and channel B pulses.

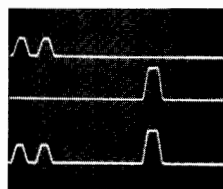
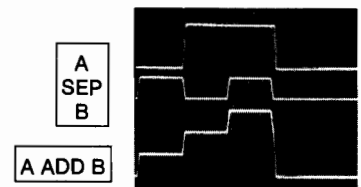

A  
SEP  
B

A ADD B

Transponder circuits need accurate delays, often with respect to a double-pulse interrogation signal. This is arranged by operating one channel in double pulse mode and setting up the transponder delay in the other.

A critical test for digital circuits and ICs is its glitch and noise sensitivity, which can be easily performed with the A ADD B mode.

A  
SEP  
B

A ADD B

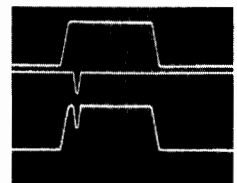

# PULSE GENERATORS

MATE-approved stimuli

HP 8160A, 8161A

455



## User Features

### Fast, Reliable Setup

Microprocessor control promotes highly accurate pulses. Parameters are directly entered via the instrument's keyboard, and are then displayed on numeric LED's with 3-digit resolution.

In bench applications, the vernier controls give a fine adjust capability to "tweak-in" any pulse parameter. You can increment or decrement the selected parameter either in single steps or at speed.

Error detection by the microprocessor further simplifies pulse set-up by solving the old problem of incompatible settings. Should pulse width exceed pulse period, for example, the microprocessor indicates a TIMING error. All possible mis-settings are detected and the type of error is indicated to aid rapid correction.

### HP-IB Programming

Microprocessor control over all interface functions makes remote programming as easy and straight-forward as manual control. The instruments employ keystroke programming so that data entry via the HP-IB is an exact simulation of manual entry. Bus commands for each front panel key simply replace manual keystrokes.

### Specifications

Specifications apply over the temperature range 20°C to 40°C, with an output load of 50 ohms. More detailed specifications are available in the product data sheets.

#### Period

**Range:** 20 ns to 999 ms (HP8161A: 10 ns to 980 ms).

**Basic accuracy:** ± 3%.

**Basic jitter:** 0.1% pp

#### Delay/double pulse, width

**Range:** 0.0 ns to 999 ms (HP8161A: 0 ns to 990 ms).

**Basic accuracy:** ± 1%.

#### Transition times (10 - 90% of amplitude)

**Range:** 6.0 ns to 9.99 ms (HP8161A: 1.3 ns to 900 us).

**Basic accuracy:** ± 3% (HP8161A: ± 10%).

#### Output (50 ohms into 50 ohms)

**Amplitude:** 0.10 to 9.99 V (HP8161A: 0.06 to 5.00 V).

**Window:** ± 9.99 V (HP8161A: ± 5.00 V)

**Basic accuracy:** ± 1%.

**Source resistance:** 50 ohm (HP8160A: 50 ohm / 1 kohm selectable. Output voltages double when 1 kohm is selected).

**Normal/complement:** selectable (HP8161A without Option 020 has normal and complement outputs).

**Channel addition:** selectable with Option 020, 3- and 4-level signals feasible. Maximum output: 20 V pp (HP8161A, 5 Vpp).

**Operating modes:** normal, trigger, gate, ext burst (0-9999 pulses), double pulse.

**HP-IB capability:** all modes and parameters can be programmed. Talk mode for status, error messages, stored parameters.

**Memory:** 9 programmable locations\*.

1 location for active operating state\*.

1 location with fixed parameter set.

**Capacity:** 1 complete operating state per location.

\*Battery back-up for power-off storage

### Parameter Storage

Complete parameter and mode information for 9 independent instrument set-ups can be stored. Waveforms may be stored and recalled either manually or via the HP-IB.

By utilizing a single command to recall an entire instrument set-up, controller time is saved. In simple repetitive testing applications, storage of test waveforms gives a high degree of user convenience without an external controller.

### Learn Mode

When interrogated by the system controller, the instruments output a character string to the interface bus. This string completely describes the pulser's current set-up or any one of its stored parameter sets. Using Learn Mode, you can enter and try out waveforms manually and then automatically transfer them via the HP-IB to the controller for storage in a program.



HP 8161A

### General

**Recalibration period:** 1 year.

**Repeatability:** factor 2 better than specified accuracy.

**Operating temperature:** 0°C to 50°C (Specifications apply from 20°C to 40°C. Accuracy derating factors for 0°C to 20°C and 40°C to 50°C).

**Power:** 115/230 V ac + 10%, -22%, 48-66 Hz; 675 VA max.

**Weight:** net 20.8 kg (46 lbs). Shipping 25 kg (55 lbs).

**Size:** 178 H x 426 x 530 mm D (7" x 16.8" x 20.9").

### Ordering Information

	Price	
	HP 8160A	HP 8161A
HP 8160A/8161A programmable pulse generator*	\$16,500	\$18,800
Opt 001 Rear panel inputs and outputs	\$0	\$0
Opt 020 Second channel (Rate common)	\$7,650	\$8,100
Opt 700 Built-in MATE/CIIL compatibility	\$3,060	\$3,060
Opt 907 Front handle kit (HP 5062-3990)	\$66	\$66
Opt 908 Rack flange kit (HP 5062-3978)	\$36	\$36
Opt 909 Opt 907, 908, combined (HP 5062-3984)	\$92	\$92
Opt 910 Set of operating/programming and service manuals	\$122	\$153
Opt W30 Extended repair service. See page 723	\$380	\$310

\* HP-IB cables not supplied, see page 579

☎ For same-day shipment, call HP-DIRECT at 800-538-8787

# PULSE GENERATORS & DATA GENERATORS

## 250 MHz Fast Pulse Source HP 8082A

- < 1 ns variable transition times
- Ultra-clean 50 ohm source
- Switch-selectable ECL levels
- Dual  $\pm 5$  V outputs



HP 8082A

The HP 8082A is a fast pulse generator with all pulse parameters variable. With repetition rates to 250 MHz, transition times down to 1 ns and amplitudes to 5 V, the HP 8082A is ideally suited for state-of-the-art TTL and ECL logic designs. Using the HP 8082A, you can rapidly test logic circuits under all operating conditions by simply varying pulse parameters. Although a highly sophisticated instrument, the HP 8082A is still easy to operate because of its logical front panel layout and switch selectable ECL output levels. Another feature that contributes to ease of operation is the square wave mode. You can, for example, carry out toggle rate tests in this mode up to 250 MHz without having to worry about pulse duty cycle.

Hybrid IC's, manufactured by Hewlett-Packard, are used extensively in the design of the HP 8082A. These ICs eliminate the need for fans, reduce power consumption and enable a low reactance 50 ohm source impedance to be used. This source impedance absorbs 98% of reflections from signals up to 4 V amplitude.

### Specifications

#### Pulse Characteristics (50 $\Omega$ source and load impedance)

**Transition times:** (10% to 90%): 1 ns to 0.5 ms in 6 ranges at amplitudes >1.8 V and >4.5 V respectively in the two upper output ranges. Minimum value may increase to 1.2 ns at other amplitudes. Leading/trailing times are common on fastest range, and independently variable over 1:10 ratio on other ranges.

**Overshoot and ringing:**  $\leq \pm 10\%$  of pulse amplitude may increase to  $\pm 10\%$  with amplitude vernier CCW.

**Preshoot:**  $\leq \pm 5\%$  of pulse amplitude.

**Linearity:** linearity aberration for both slopes  $\leq 5\%$  for transition times > 5 ns.

**Output:** maximum amplitude is 5 V from 50  $\Omega$  into 50  $\Omega$ . Maximum output voltage is  $\pm 5$  V (amplitude + offset).

**Offset:**  $\pm 2$  V, into 50  $\Omega$ .

**DC-source impedance:** 50  $\Omega$  +5% -10%.

**Reflection coefficient:** 5% in ECL setting, increasing to 15% in 5 V range.

**Output protection:** cannot be damaged by open or short circuits or application of ext.  $\leq \pm 6$  V or  $\pm 200$  mA independent of control settings.

**Attenuator:** two separate three step-attenuators reduce the outputs to 1 V. Vernier is common for both outputs and reduces the output to 0.4 V minimum. A further position provides ECL-compatible outputs ( $-0.9$  V to  $-1.7$  V typ. open circuit).

#### Timing

**Repetition rate:** 250 MHz to 1 kHz in 6 ranges.

**Period jitter:** <0.1% of setting +50 ps.

**Delay:** 2 ns -0.5 ms in 6 ranges plus typ. 17 ns fxd. with respect to trigger output. Duty cycle >50%.

**Delay jitter:** <0.1% of setting +50 ps.

**Double pulse:** up to 125 MHz max. (simulates 250 MHz).

**Pulse width:** 2.4 ns to 0.5 ms in 6 ranges.

**Width jitter:** <0.1% of setting +50 ps.

**Width duty cycle:** >50%.

**Square wave:** delay and double pulse are disabled, max. Rep. Rate 250 MHz. Duty cycle is 50%  $\pm 10\%$  up to 100 MHz, 50%  $\pm 15\%$  for >100 MHz.

**Trigger output:** negative going Square Wave (50% duty cycle typ.) >500 mV from 50  $\Omega$  into 50  $\Omega$ . Internal 50  $\Omega$  can be switched off by slide-switch on PC-board. Amplitude up to 1 V into 50  $\Omega$  up to 200 MHz.

**Trigger output protection:** cannot be damaged by short circuit or application of external  $\pm 200$  mA.

### External Operating Modes

#### External Input

**Input impedance:** 50  $\Omega$   $\pm 10\%$ , dc coupled.

**Maximum input:**  $\pm 6$  V.

**Trigger level:** adjustable -1.5 V to +1.5 V.

**Slope control:** positive, negative or manual selectable. In the manual position all ext. functions can be controlled by push button. Button pushed in simulates an "on-signal."

**Sensitivity:** sine-wave >200 mV p-p pulses >200 mV.

**Repetition rate:** 0 to 250 MHz.

#### External-Controlled Modes

**External trigger:** there is approximately 7 ns delay between the external input and the trigger output. Rep. rate is externally controlled (is triggered by external signal). Trigger output provides the pulse-shaped input signal.

**Synchronous gating:** gating signal turns rep. rate generator on. Last pulse normal width even if gate ends during pulse.

**External width:** output pulse width determined by width of drive input. Rep. rate and delay are disabled. Trigger output provides shaped input signal.

### General

**Operating temperature:** 0°C to 55°C.

**Power:** 100/120/220/240 Vrms; +5%, -10%; 48-440 Hz. 85 VA max.

**Weight:** net, 7.9 kg (17.44 lb). Shipping 8.9 kg (19.63 lb).

**Size:** 133 H x 426 W x 345 mm D (5.2" x 16.75" x 13.6").

### Ordering Information

HP 8082A Pulse Generator

Opt 907 Front Handle Kit (HP 5062-3989).

Opt 908 Rack Flange Kit (HP 5062-3977).

Opt 909 Opt 907, 908 Combined (HP 5062-3983).

Opt 910 Additional Operating and Service Manual

Opt W30 Extended repair service. See page 723.

For same-day shipment, call HP DIRECT at 800-538-8787.

### Price

\$6,200

+\$56

+\$33

+\$82

+\$28

+\$195



# PULSE GENERATORS & DATA GENERATORS

## High Resolution Time Synthesizer

HP 5359A

457

- Precise digital delays 0-160 ms
- 50 ps increments
- Jitter < 100 ps

- Programmable
- Fully synchronous to external trigger
- Automatic calibration

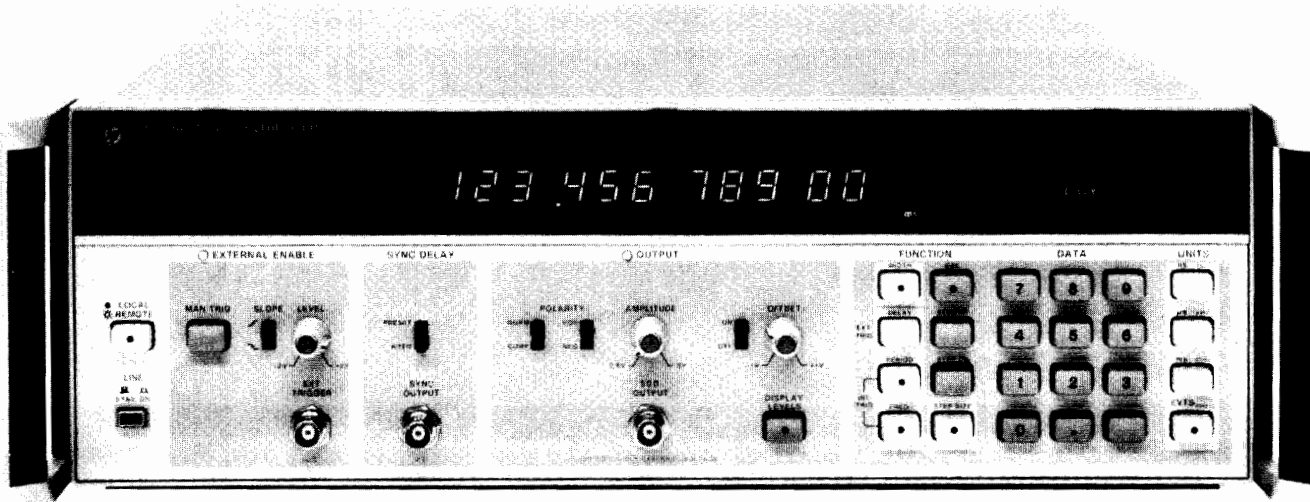

HP 5359A



### HP 5359A Time Synthesizer

The HP 5359A Time Synthesizer produces two extremely precise, low jitter time delays. These delays,  $T_d$  and  $T_w$ , are individually selectable by means of the keyboard, in 50 ps or greater steps to generate delays of up to 160 ms.

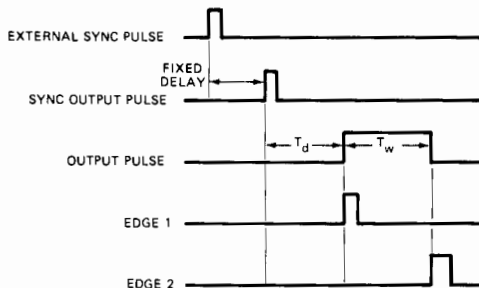

The HP 5359A has many applications and may be used for the calibration of Radar, Loran, DME and Tacan Systems, or for precision generation of delayed sweeps in oscilloscopes, and for extremely accurate "time positioning" control of external gates on frequency counters. In component and circuit test, the instrument may be used for extremely accurate delay line simulation.

### Condensed Specifications

#### Modes

**External trigger mode:** the delays from the sync out to the beginning of the output pulse, and the width of the output pulse, are selected.

**Internal trigger mode:** the "period" or "frequency", and the width of the output pulse, are selected.

#### Range

**Delay  $T_d$ :** 0 ns to 160 ms.

**Width  $T_w$ :** 5 ns to 160 ms (width & delay  $\leq$  160 ms).

**Period:** 100 ns min or width + 85 ns; 160 ms max.

**Frequency:** same as corresponding "period".

**Repetition rate:** 10 MHz max.

**Accuracy:**  $\pm 1$  ns  $\pm$  time base error ( $\pm 100$  ps  $\pm$  time base error after external calibration).

**Insertion delay:** fixed at <150 ns; selectable as <50 ns for delays >100 ns.

**Jitter:** typical 100 ps rms; maximum 200 ps rms (delays to 10 ms).

**External trigger input:** -2 V to +2 V slope selectable.

**Sync output:** 1 V - 50  $\Omega$ ; 5 V - 1 M $\Omega$ . Width 35 ns nominal.

#### Output Pulse

**Amplitude:** 0.5 V to 5 V into 50  $\Omega$ .

**Polarity:** positive or negative.

**Offset:** -1 V to 1 V, or OFF.

**Transition time:** <5 ns.

External voltage must not be applied. Offset and Amplitude voltage into 50  $\Omega$  may be displayed.

**EDGE 1 OUTPUT (rear panel):** occurs in Sync with leading edge of output pulse (same spec. as Sync out).

**EDGE 2 OUTPUT (rear panel):** occurs in Sync with falling edge of output pulse (same spec. as Sync out).

**Events mode:** substitutes external input (to 100 MHz) for the internally counted clock (delay and width must both be specified in terms of events instead of time).

**Triggered frequency mode:** the same as internal frequency mode except the output is a burst beginning in synchronism with an external trigger signal, and continues for the duration of this signal.

**Calibrate mode:** performs an internal calibration to remove the effects of internal delay differences.

**HP-IB:** All controls except trigger levels are programmable as standard.

#### Time Base

High Stability Oven Oscillator

**Frequency:** 10 MHz.

**Aging:**  $< 5 \times 10^{-10}$ /day.

**Temperature:**  $< 2.5 \times 10^{-9}$ , 0°C to 50°C.

**Line voltage:**  $< 1 \times 10^{-10}$ ,  $\pm 10\%$  from nominal.

**Size:** 133 H x 426 W x 521 mm D (5.25 in. x 16.75 in. x 20.50 in.).

**Weight:** 13.6 kg (30 lb).

**Power requirements:** 100, 120, 220, or 240 Vac +5% -10%, 48 to 66 Hz, less than 250 VA.

**Front handles:** supplied with instrument.

#### Ordering Information

HP 5359A Time Synthesizer

Opt 908 Rack Flange Kit for use without handles

Opt 913 Rack Flange Kit for use with supplied handles

Opt W30 Extended repair service. See page 723

Opt W32 Calibration service. See page 723

HP 10870A Service Kit

**Price**

\$14,000

+ \$33

+ \$35

\$1,200

# PULSE GENERATORS & DATA GENERATORS

## Fast, High Power Pulse Generator HP 214B

- High power 100 V, 2 A output into 50  $\Omega$
- 10 MHz repetition rate
- Constant duty cycle
- Counted pulse burst option

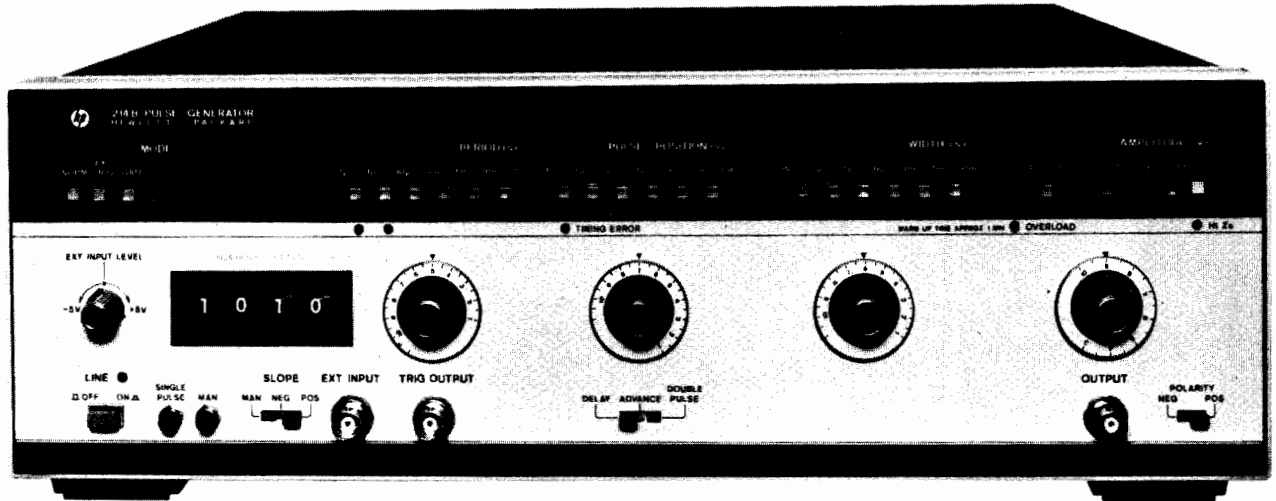

Picture shows 214B with Option 001, Counted Burst.

The HP 214B pulse generator employs semiconductor technology for high power pulse generation at up to 10 MHz repetition rate. Delivering 100 V pulses with 15 ns risetimes, the HP 214B meets the speed demands of today's applications.

State-of-the-art VMOS FETS used as current sources for the output amplifier tubes enable pulse width to be specified down to 25 ns. The HP 214B is thus well-equipped for low duty cycle applications such as laser diode pulsing or transient simulation.

Where changing duty cycle threatens destruction to the device under test, the HP 214B Constant Duty Cycle (CDC) mode provides device protection. In CDC operation the duty cycle, hence power, remains constant as frequency is varied. The HP 214B is itself protected against excessive duty cycles via an overload protect circuit.

Easy operation is assured by the timing error indication. Calibrated dials enable fast accurate adjustments. Operating into unmatched loads, clean pulse shape is guaranteed by the low reactance 50  $\Omega$  source impedance. Pulse distortions such as preshoot and overshoot are specified as 5% at all amplitudes.

## Specifications

### Timing

**Repetition rate:** 10 Hz to 10 MHz in 6 ranges. In 30 V - 100 V amplitude range, maximum rep. rate is 4 MHz. Calibrated vernier provides continuous adjustment within ranges. **Vernier accuracy:**  $\pm(10\%$  of setting + 1% full scale). **Period Jitter:**  $\leq 0.1\% + 300$  ps.

**Pulse delay/advance:** pulse can be delayed/advanced with respect to the trigger output from 10 ns to 10 ms ( $\pm$  fixed delay of 45 ns) in 5 ranges. Calibrated vernier provides continuous adjustment within ranges. **Vernier accuracy:**  $\pm(10\%$  of setting + 1% full scale) + fixed delay. **Position Jitter:**  $\leq 0.1\% + 500$  ps

**Maximum pulse position duty cycle:**  $\geq 50\%$

**Double pulse:** 5 MHz maximum in all ranges except 30 V - 100 V range which is max. 2 MHz. Minimum separation is 100 ns.

**Pulse width:** 25 ns to 10 ms in 6 decade ranges. Calibrated vernier provides continuous adjustment within ranges. **Accuracy:**  $\pm(10\%$  of setting + 1% full scale) + 5 ns. **Width Jitter:**  $\leq 0.1\% + 500$  ps.

**Max. duty cycle:**  $\geq 10\%$  for 30 - 100 V range.  $\geq 50\%$  all other ranges.

**Constant duty cycle mode (disabled in ext. trigger mode):** duty cycle of output pulse remains constant as the period is varied. The duty cycle limits in this mode are typically 8% fixed for the 10 M - 1 MHz range (max. 4 MHz); 2.5% to 10% for 1 MHz - .1 MHz range; .25% to 10% for .1 MHz - 10 kHz range; 0.1% for all other ranges. Calibrated vernier provides continuous adjustment within ranges.

**Accuracy:**  $\pm(15\%$  of setting + 1% of full scale).

### Trigger Output

**Amplitude:**  $\geq +5$  V (50 ohm into open circuit).

**Pulse width:** 10 ns typical.

### External Operating Modes

#### External Input (impedance 10 k ohm, dc coupled)

**Repetition rate:** dc to 10 MHz. **Sensitivity:** 500 mVpp, dc coupled.

**Slope:** pos. or neg. **Trigger level:** +5 V to -5 V adjustable.

**Maximum input level:**  $\pm 100$  V. **Trigger pulse width:**  $\geq 10$  ns.

**EXT TRIG mode:** an output pulse is generated for each input pulse. **GATE mode:** gate signal turns on rep. rate generator synchronously. Last pulse always completed.

**BURST mode (optional):** preselected number of pulses generated on receipt of trigger signal. **Number of pulses:** 1 to 9999. Minimum spacing between bursts: 200 ns.

**Manual:** pushbutton can be used for triggering single pulses (EXT TRIG mode), generating gate signals (GATE mode) or triggering pulse bursts (BURST mode).

### Output

**Amplitude:** 0.3 V to 100 V in 5 ranges. Calibrated vernier provides adjustment within ranges. **Vernier accuracy:**  $\pm 10\%$  of setting.

**Source impedance:** fixed 50  $\Omega$  nominal on ranges up to 10 V. Selectable 50  $\Omega$  nominal or HI-Z on 10 - 30 - 100 V ranges (with 50  $\Omega$  / 50  $\Omega$  impedance, amplitude decreases to 5 - 15 - 50 V).

**Polarity:** pos. or neg. selectable.

**Transition times:**  $\leq 15$  ns for leading and trailing edges.

**Pulse top perturbations:**  $\leq \pm 5\%$  of amplitude.

### General

**Operating temperature:** 0°C to 55°C.

**Power:** 100/120/220/240 Vrms; +5%, -10%, 48 to 66 Hz, 360 VA max.

**Size:** 133H x 426W x 422 mm D (5.2" x 16.8" x 16.6").

**Weight:** net 13.6 kg (30 lb). Shipping 15.6 kg (34.3 lb).

### Ordering Information

HP 214B Pulse Generator

Opt 001 Counted Burst

Opt H04 48-440 Hz Line

Opt 907 Front Handle Kit (part number HP 5061-9689).

Opt 908 Rackmount Kit (part number HP 5061-9677).

Opt 909 Opt 907, 908 Combined (part number HP 5061-9683).

Opt 910 Set of Operating/Progr. and Service Manuals

Opt W30 Extended repair service. See page 723.

☎ For same-day shipment, call HP DIRECT at 800-538-8787.

### Prices

\$5,100

\$800

on request

\$56 ☎

\$33 ☎

\$82 ☎

\$34

\$120

- Independent rise and fall times from 5 ns to 0.5s
- Output voltage up to 10V
- Selectable source impedance
- A high-quality, low-cost pulse solution

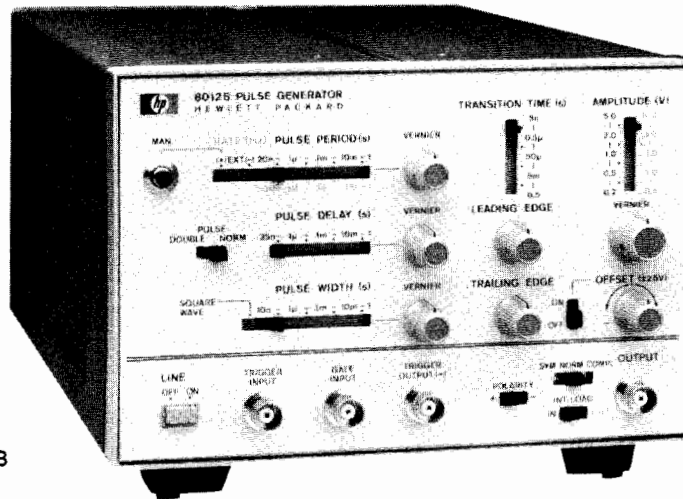

HP 8012B

### HP 8012B 50 MHz Pulse Generator

The HP 8012B is a versatile and reliable low-cost pulse generator. It provides an excellent solution for those requiring clean pulses with low noise and fast edges. Independently variable rise and fall times allow the user to optimize switching speeds for use with digital circuits, while variable amplitude and dc offset let you match levels to CMOS, ECL, TTL, and many other IC technologies. For amplitudes greater than 5V, you can switch out the internal 50-ohm load to double the output voltage.

### Flexible Operation

The HP 8012B provides operating modes to satisfy many basic pulse generator applications. External triggering and gating, double pulse mode, and external width mode combine to make design of your pulse simple and effective. The clear front-panel layout encourages creation of the desired waveform without timing errors.

### Low Cost Stimulus Source

Stimulus-response testing is an excellent way to characterize ICs, boards, and other system elements. The HP 8012B is a high-quality, low-cost pulse source for such a system. When combined with one of HP's wide range of digitizing oscilloscopes, the HP 8012B fits your device test application cleanly and inexpensively.

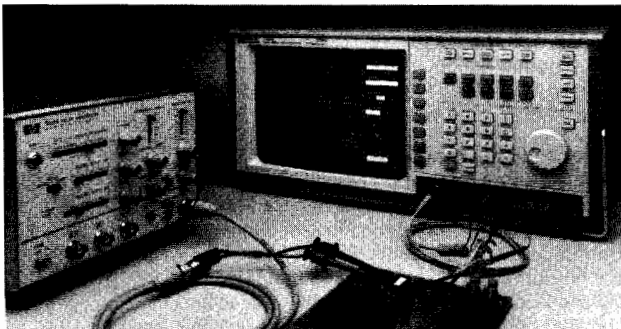

Stimulus-response solution: the HP 8012B and the HP 54504A digitizing oscilloscope

### Specifications

#### Pulse parameters

- Jitter:** <0.1% of programmed value + 50 ps.
- Period:** 20 ns to 1 s (1 Hz to 50 MHz)
- Delay:** 35 ns to 1 s
- Width:** 10 ns to 1 s
- Maximum duty cycle:** 75% up to 10 MHz.
- Transition times:** 5 ns to 0.5 s
- Source impedance:** switchable between 50 ohms and high Z.
- Amplitude:** 0.2V to 5V, 50 ohm source into 50 ohm load. 0.2V to 10V into high impedance load or with high impedance source.
- Offset:** ± 2.5V; active only when using 50 ohm source.

#### Pulse performance

- Overshoot and ringing:** ± 5% of amplitude; ± 10% of amplitude (0.4 -4V) when using high impedance source.
- Preshoot:** ± 5% of amplitude

### Supplementary Characteristics

(values describe typical, non-warranted performance)

#### Operating modes

- Normal:** continuous pulse stream
- External:** selected external input transition (+ or -) triggers output. Min. external signal width 7 ns.
- Gate:** positive external input edge starts synchronous output. Negative external edge stops output after completion of current pulse.
- Other:** Double Pulse, Square Wave, External Width, RZ

### General Information

- Operating temperature:** 0°C to 55°C
- Power:** 100/120/220/240 +10%/-15% Vrms. 48 - 440 Hz, 70 VA.
- Weight:** net, 4 kg (9 lbs); shipping, 6.5 kg (14.6 lbs)
- Size:** 142H x 200W x 330mmD (5.6" x 7.9" x 13")

### Ordering Information

- |   |                         |
|---|-------------------------|
| HP 8012B pulse generator (includes power cord and operating / service manual) | <b>Price</b><br>\$2,000 |
| Opt 910 additional operating and service manual                               | +\$20                   |
| Opt W30 Extended repair service. See page 723.                                | +\$65                   |

### Accessories

- |                         |       |
|-------------------------|-------|
| HP 15179A rackmount kit | \$235 |
|-------------------------|-------|
- All accessories included for mounting one or two pulse generators.

# PULSE GENERATORS & DATA GENERATORS

## Versatile 50 MHz Source

HP 8112A

- Full pulse capability
- Modulation
- Ramps and haversines
- Width/duty cycle
- Device protection
- Error recognition and self test

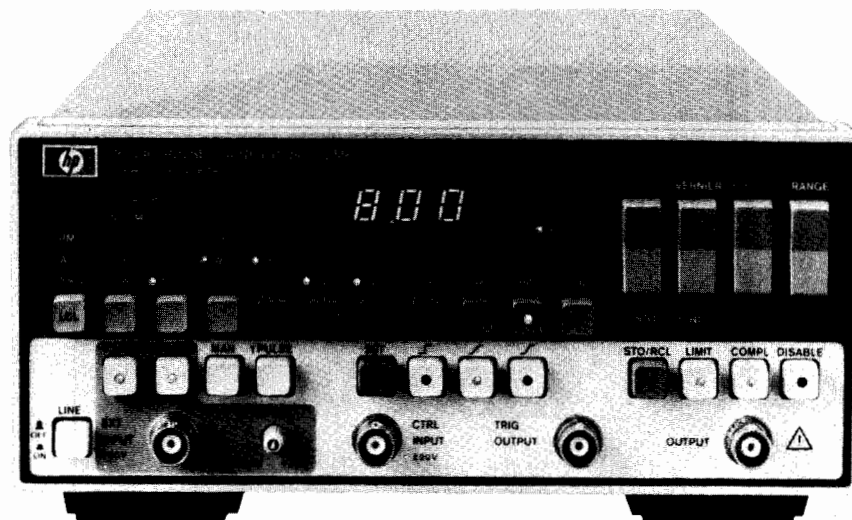

HP 8112A



Supported by  
**HP ITG**  
Software

### HP 8112A Pulse Generator

The HP 8112A is a fully programmable 50 MHz pulse generator with 5 ns transitions and 32 V<sub>pp</sub> (into open circuit) max output amplitude. All pulse parameters are variable including delay and double pulse spacing.

Besides the comprehensive trigger modes, external modulation capabilities extend applicability. 3-level signals and upper level, width, period and delay-modulated signals are available. These can be combined with the trigger modes so that complex real-life signals like modulated bursts are simulated easily.

Step response and trigger hysteresis measurements require fast transitions or sawtooth signals as obtained in the HP 8112A's linear transition mode—either fixed 5 ns or variable from 6.5 ns. The new cosine transitions, also variable from 6.5 ns, mean that band-filtered signals are now just as simple to obtain.

Sensitive devices are protected by programming output limits and the upper level can be controlled by the device supply. Also, constant energy or constant width can be programmed.

Dual channel operation is feasible by operating HP 8112A's in a master/slave combination.

For really easy operation a green button gives error-free settings. A new softkey operating concept plus detailed error recognition make the HP 8112A's powerful versatility easy to handle.

### Specifications

Specifications apply with 50-ohm load, and temperatures in the range 0°C to 55°C.

**Timing** (specifications apply for min transition times)

**Period:** 20.0 ns to 950 ms.

**Delay:** 75.0 ns to 950 ms.

**Double pulse:** 20.0 ns to 950 ms.

**Width:** 10.0 ns to 950 ms.

**Accuracy:** ± 5% of progr value ± 2 ns (delay: ± 4 ns).

**Duty cycle:** 1% to 99% (Min: 10 ns. Max: period - 10 ns).

**Accuracy:** ± 10% of progr value.

**Pulse Characteristics** (voltages double when driving into open circuit)

#### Levels

High level: -7.90 V to 8.00 V.

Low level: -8.00 V to 7.90 V.

Accuracy: ± 1% of progr value ± 3% amplitude ± 40 mV.

Settling time: 100 ns + transition time.

### Transition times

Fixed: 5 ns typical

Linear and Cosine: 6.5 ns to 95.0 ms (max edge ratio 1:20 within a 1.5-decade range. Ranges overlap by 0.5 decade).

Accuracy: ± 5% of programmed value ± 2 ns.

**Preshoot, overshoot, ringing:** ± 5% ± 10 mV (variable transitions), ± 10% ± 10 mV (fixed transitions).

**Output resistance:** 50 ohm ± 5%.

**Operating modes:** Normal, Trigger, Gate, Ext Width (pulse restoration), Ext Burst (1 to 1999 pulses).

### Control (Modulation) Modes

**Period, delay, width** covered in 8 non-overlapping decades (max input frequency 8 kHz.).

**High level:** -8 V to +8 V, independent of progr low level (min input transition 200 μs).

### General

**HP-IB:** all keys programmable. Learn, status and error reporting capability. HP-IB interface functions: SH1, AH1, T6, L4, SR1, RL1, PP0, DC1, DT1.

**Memory:** retains current operating state. 9 store/recall locations, 1 fixed set of parameters.

**Repeatability:** factor 4 better than accuracy.

### Environmental

Storage temperature: -40°C to +65°C.

Operating temperature: 0°C to 55°C.

Humidity: 95% RH, 0°C to 40°C.

**Power:** 100/120/220/240 V rms; +5%; -10%; 48 to 440 Hz; 120 VA max

**Weight:** net, 5.9 kg (13 lb). Shipping, 8.0 kg (18 lb).

**Size:** 89 H x 212.3 W x 450 mm D (3.5" x 8.36" x 17.7").

### Ordering Information

HP 8112A Programmable Pulse Generator\* \$6,000

Opt 910 Extra Operating and Service Manual \$49

Opt W30 Extended Repair Service. See page 723 \$150

HP 5062-4001 Bail Handle Kit \$38

HP 5062-3972 Rackmount Kit (single HP 8112A) \$51

HP 5062-3974 Rackmount Kit (two instruments) \$31

HP 5062-3994 Lock Link Kit (for use with HP 5062-3974) \$40

\* HP-IB cables not supplied, see page 706

For same-day shipment, call HP DIRECT at 800-538-8787

### Prices

\$6,000

\$49

\$150

\$38

\$51

\$31

\$40



# PULSE GENERATORS

## 50 MHz Dual Channel Pulse Generator

### HP 8115A

461

- "Two HP 8112As in one"
- Simulates data/clock signals

- Displays both channels
- Multi-level signals

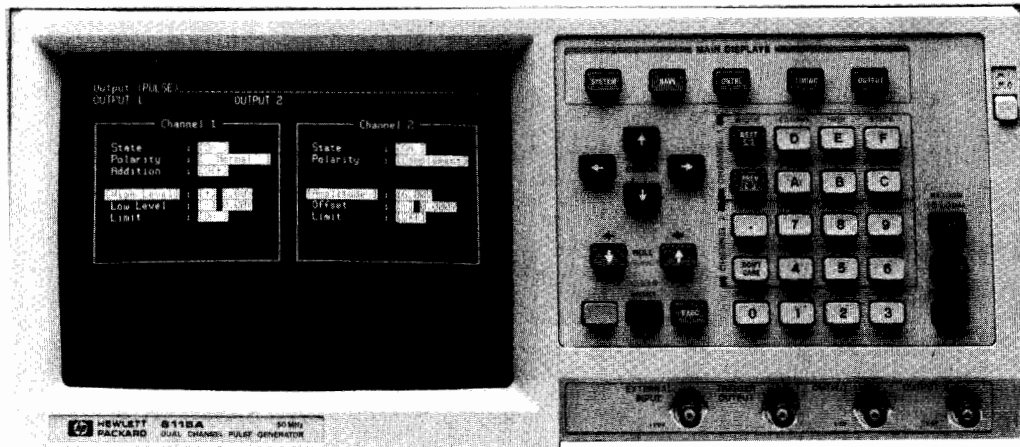

HP 8115A



### Bench and ATE-System suitable

The HP 8115A is a fully programmable 50 MHz dual channel pulse generator, which delivers pulse trains with up to 32 V<sub>p-p</sub> into high impedance and variable transitions from 6.5 ns up to 95 ms.

The HP 8115A is suitable to operate as a stand-alone instrument or in an ATE-System. The specifications are for a wide temperature range, 0°C to 55°C, useful for ATE-Systems. Much higher accuracy is achieved in the limited temperature range 20°C to 30°C; this is useful for bench-top applications which require higher accuracy. The high and low level for each channel is independently programmable. The output voltages can also be programmed as amplitude and offset.

### Two Channels / Channel Addition

Two channels are available; they are designed as parameter-independent but synchronous outputs. With the delay capability, phase-shifted signals can be achieved. The two channels can be added, thus 3-level, 4-level signals or spikes can be created.

### Specifications

Specifications describe the instrument's warranted performance (30 minutes warm-up, 50-ohm load) at 0°C to 55°C [20°C to 30°C] ambient temperature.

### Timing Parameters

(measured at 50% of amplitude with fastest edges).

#### Common Specifications:

Resolution	3 digits (best case 100 ps)
Repeatability	factor 4 better than accuracy
RMS-jitter*	0.05% of programmed value + 30 ps
<b>Period (PER)</b>	20 ns to 950 ms
Accuracy	±5% of progr. value ±2 ns [±2% ±1 ns]
<b>Delay (DEL)</b>	75 ns to 950 ms (max: PER + 55 ns)
Accuracy	±5% of progr. value ±4 ns [±2% ±4 ns]

\*see page 449

### Double Pulse (DOUB)

20 ns to 950 ms (max: PER - WID)  
Accuracy ±5% of progr. value ±2 ns [±2% ±2 ns]

### Width (WID)

10 ns to 950 ms (max: PER - 10 ns)

Accuracy ±5% of progr. value ±2 ns [±2% ±2 ns]

### Linear Transitions (between 10% and 90% of ampl)

Range 6.5 ns to 95 ms

Accuracy ±5% of progr. value ±2 ns [±5% ±2 ns]

### Output (voltages double when driving into open)

<b>High Level</b>	-7.90 V to +8.00 V
<b>Low Level</b>	-8.00 V to +7.90 V
Resolution	3 digits (best case 10 mV)
Level-Accuracy	±1% of progr. value ±3% of ampl. ±40 mV [±1% ±1% ±20 mV]
Repeatability	factor 4 better than accuracy

### Supplemental Specifications

<b>Trigger Modes</b>	Manual, Auto, Trigger, Gate
<b>Addition</b>	Adds up channel 2 to channel 1.
<b>Control Modes</b>	High level, Period, Delay, Width

### General

<b>Storage Temperature</b>	-40°C to +65°C
<b>Operating Temperature</b>	0°C to 55°C
<b>Power</b>	100-120/220-240 Vrms, ±10%, 450 VA max., 48-66 Hz
<b>Weight</b>	16 kg (35.5 lb)
<b>Dimensions (H*W*D)</b>	190 mm * 426 mm * 584 mm, [7.5 in * 16.75 in * 23 in]
<b>Recalibration Period</b>	1 year recommended

### Ordering Information

<b>HP 8115A 50 MHz Dual Channel Pulse Generator</b>	<b>Price</b>
Opt 908 Rack Flange Kit (P/N 5062-3978)	\$10,300
Opt 910 Set of Operating/Programming and Service Manuals	\$138
Opt 915 Service Manual (P/N 08115-90001)	\$106
Opt 916 Additional Operating and Programming Manual (P/N 08115-90011)	\$32
Opt W30 Extended repair service. See page 723	\$140

☎ For same-day shipment, call HP DIRECT at 800-538-8787

# PULSE GENERATORS & DATA GENERATORS

## 100 Mbit/s Pulse Pattern Generator

HP 8118A

- 2 channels / 16 kbit each / 100 Mbit/s each
- Strobe channel (bit, word, or frame trigger)
- Variable word and frame length
- Variable width and delay
- Rise/fall time separately programmable
- Variable high and low level, channel addition

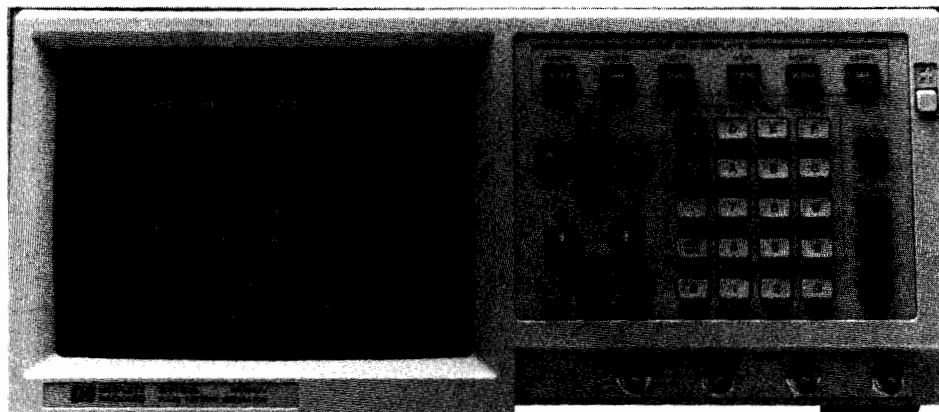

HP 8118A

### HP 8118A Pulse Pattern Generator

#### Parametric and Functional Test

The HP 8118A is a two-channel pulse and serial data generator. It provides full control over voltage levels, timing, and transition times in all operating modes, and in its pattern mode offers patterns of up to 16 kbits with programmable word and frame lengths, and up to 100 Mbit/s data rate, NRZ, 50 Mbit/s RZ.

The HP 8118A is an excellent combination of a fully programmable serial data generator and a pulse generator in one package. It offers functional test capabilities for testing ICs, modules, and boards. With the built-in parametric capabilities, it is possible to combine the digital information with the signal degradation that occurs in practice, allowing evaluation of the effect of worst-case conditions on your device-under-test.

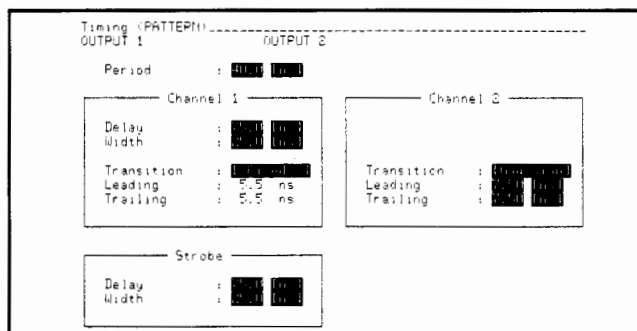

Timing parameter display of both channels and the additional strobe channel.

#### Powerful Editor

The HP 8118A offers a convenient and comprehensive set of editing capabilities, making creation of the serial data pattern required for your application quick and easy. The digital patterns you create can also be combined with PRBS (pseudo-random-binary-sequence) capability to make segments of random data or a complete PRBS pattern. Word- and frame-oriented data patterns can be created using the "Word" mode of the HP 8118A, with up to 3640 words and word lengths of up to 256 bits allowable. With these features, protocols with preamble-data-postamble structure and defined word and frame lengths, as used for data transmission in serial data networks, can be rapidly created.

#### Serial Data Transmission - ISDN

The Integrated Services Digital Network provides all forms of communication, including voice, data, video, etc. Specific line codes are used for transmitting this serial data. In the United States the four-level line code 2B1Q, is about to become standard. In Europe, the three-level code AMI is used. With the HP 8118A's channel addition capability, and the help of the HP 8118A Coder program running on a Series 200/300 controller, you can enter ASCII data and convert it to the line code you require, such as 2B1Q, AMI, HDB3, Manchester II, NRZ, or RZ. Because the HP 8118A allows you to vary pulse parameters on your data pattern, you can then simulate signal degradation by changing voltage or timing parameters of the pattern output.

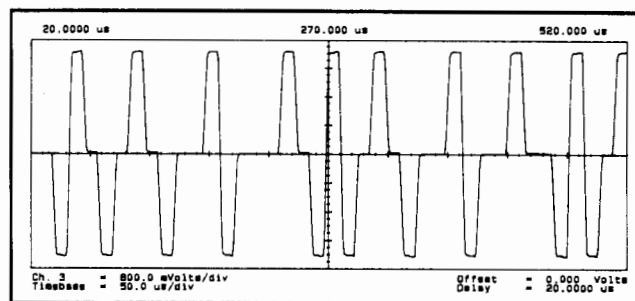

3- and 4-level signals produced by HP 8118A's internal channel addition feature.

- HDB3 signal
- 2B1Q signal

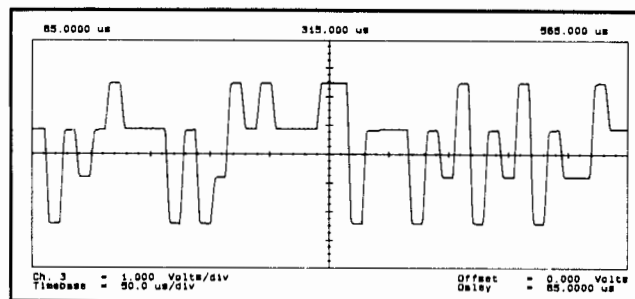

<sup>1</sup> Unsupported program available on request. Uses HP BASIC 5.1 platform.

## Burst Signals

Complex burst signals with up to 16384 pulses can be generated with the HP 8118A in its pattern mode. Burst signals are often used for testing sequential devices such as counters and shift registers. Bursts are also used in radar and navigation applications such as baseband signal injection, simulation and testing tracking circuits, phase comparators, and transmitters. Cosine edges allow near-Gaussian pulses to be set-up.

Both channels are time-synchronous and have the same period, but all other parameters - data, timing, and voltage - are independently programmable. With data on one channel, the second channel can also be added to the first to create spikes, glitches, or three- and four-level signals.

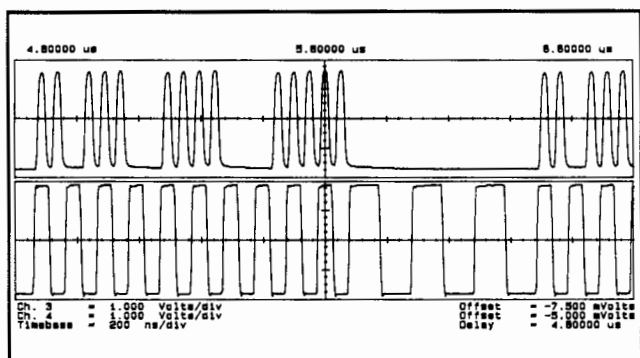

Complex burst patterns, and independent second channel.

## Specifications

Specifications describe the instrument's warranted performance (30 minutes warm-up, 50-ohm load) at 0°C to 55°C [20°C to 30°C] ambient temperature.

### Timing parameters

(measured at 50% of amplitude with fastest edges).

#### Common specifications

**Resolution:** 3 digits (best case, 100 ps)

**Repeatability:** factor 4 better than accuracy

**RMS-jitter<sup>1</sup>:** 0.05% of programmed value +30 ps

**Period (PER):** 20 (10)<sup>2</sup> ns to 950 ms

**Accuracy:** ± 5% of progr. value ± 2 ns [± 2% ± 1 ns]

**Delay:** 75 ns to 950 ms (max: PER + 55 ns)

**Accuracy:** ± 5% of progr. value ± 4 ns [± 2% ± 4 ns]

**Double pulse<sup>2</sup>:** 20 ns to 950 ms (max: PER - WID)

**Accuracy:** ± 5% of progr. value ± 2 ns [± 2% ± 2 ns]

Delay and Double pulse are mutually exclusive

**Width (WID):** 10 ns to 950 ms (max: PER - 10 ns)

**Accuracy:** ± 5% of progr. value ± 2 ns [± 2% ± 2 ns]

**Linear transitions** (between 10% and 90% of amplitude)

**Range:** 6.5 ns to 95 ms

**Accuracy:** ± 5% of progr. value ± 2 ns [± 5% ± 2 ns]

**Output** (voltages double when driving into open)

**High level:** -7.90 V to +8.00 V

**Low level:** -8.00 V to +7.90 V

**Resolution:** 3 digits (best case 10 mV)

**Level-accuracy:** ± 1% of progr. value ± 3% of amplitude  
± 40 mV [± 1% ± 1% ± 20 mV]

**Repeatability:** factor 4 better than accuracy

### Pattern

**Data capacity:** 16384 bits per channel. (In bit mode: maximum numbers of bits)

**Data formats:** RZ with programmable Delay and Width up to 50 Mbit/s, DNRZ with programmable Delay up to 50 Mbit/s, NRZ up to 100 Mbit/s

**Word length:** 3 to 256 bits, common for both channels (word mode only)

**No of words:** Number of words × word length < 16384 bits, common for both channels (word mode only)

**Random pattern:** up to 16384 bits long, PRBS sequence if blocklength is 2<sup>n</sup> - 1

## Supplement Specifications

**Trigger mode:** Manual, Auto, Trigger, Gate

**Addition:** Adds up channel 2 to channel 1

**Operating modes:** Bit Mode, Word Mode, Break, Start/Stop, Continue, Autocycle, Single Cycle

**Strobe output:** Fixed TTL levels; Delay, Width independently programmable; bit, word, of frame trigger

**Control modes:** High level, Period, Delay, Width

### General

**Storage temperature:** -40°C to +65°C

**Operating temperature:** 0°C to 55°C

**Power:** 100-120/220-240 Vrms, ± 10%, 450 VA max., 48-66 Hz

**Weight:** 17 kg (38.8 lb)

**Size:** 190H x 426W x 584mmD (7.5" x 16.75" x 23")

**Recalibration period:** 1 year recommended

## Ordering Information

	Price
HP 8118A 100 Mbit/s Pulse Pattern Generator	\$12,500
Opt 908 rack flange kit (P/N 5062-3978)	+\$36
Opt 910 set of operating/programming and service manual	+\$138
Opt 915 service manual (P/N 08118-90001)	+\$106
Opt 916 additional operating and programming manual (P/N 08118-90011)	+\$32
Opt W30 Extended repair service. See page 723.	+\$140

### Accessories

HP 1494-0059 rack slide kit	\$100
-----------------------------	-------

☎ For same-day shipment, call HP-DIRECT at 800-538-8787.

<sup>1</sup> see page 449

<sup>2</sup> 10 ns with NRZ data format

<sup>3</sup> available in Pulse Generator mode

# PULSE GENERATORS & DATA GENERATORS

## Interactive Digital/Analog Stimulus

HP 8175A

- 24 data channels
- 2 arbitrary channels

- Agile memory
- Interactive test

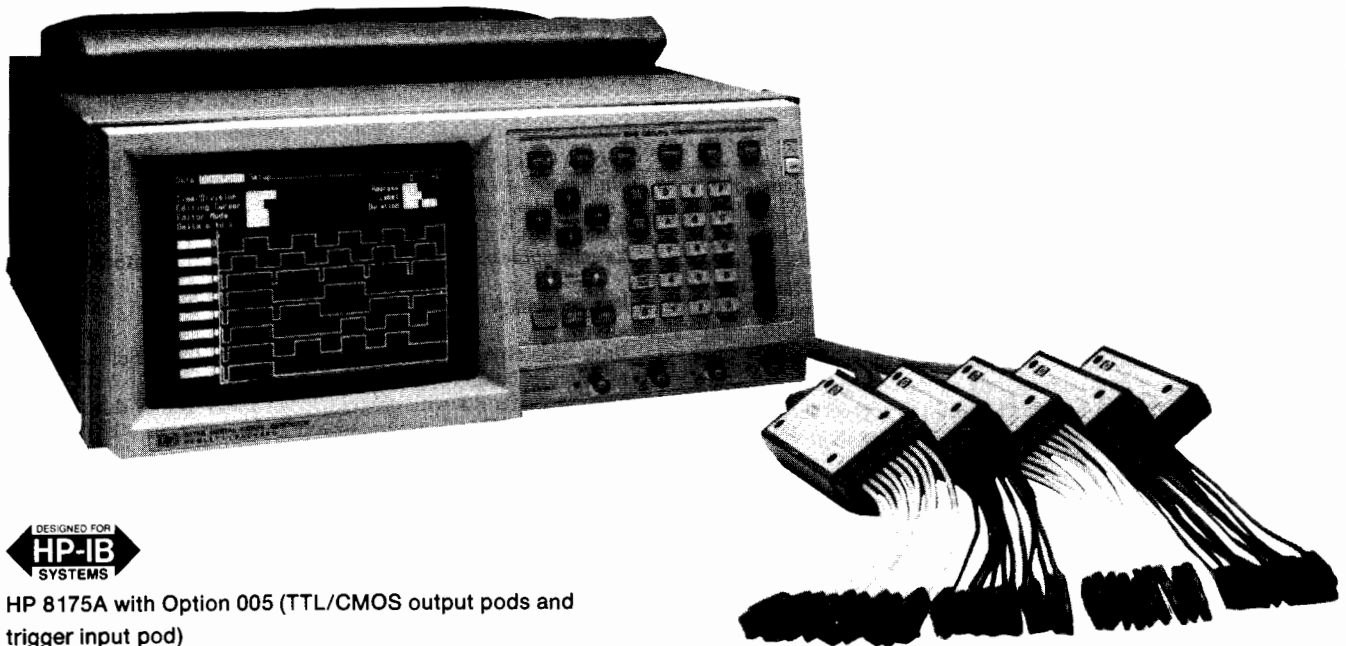

HP 8175A with Option 005 (TTL/CMOS output pods and trigger input pod)

### HP 8175A Digital Signal Generator

#### Test Under Real, Repeatable Conditions

Whether your device needs analog or digital signals or -like programmable filters- both, the HP8175A helps you emulate the real environment. This is because programmable data patterns and arbitrary waveforms can be made available at the same time. Repeatable timing and voltage settings let you test the device's limits with confidence.

#### Signal Quality at the Device

The HP8175A's 24 data outputs are connected to your device or test head by active pods. This reduces distortion because the connections between pod and device can be kept very short.

Each pod supports 8 channels so, if you are working with mixed logic, you can use any combination of the available ECL, TTL or variable-level TTL/CMOS pods.

The two analog channels of the Option 002 arbitrary waveform generator have 50-ohm outputs.

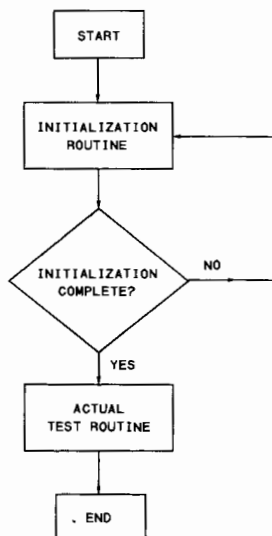

#### Interactive test

An agile, segmentable memory makes it possible for the HP 8175A to jump to different routines as needed by a test procedure. In the example on the left, an initial data pattern or waveform is output until the DUT changes state. This change is sensed by the HP 8175A's 8-line trigger pod, which then implements a user-defined jump.

Start, stop, continue and tri-state can also be implemented from the DUT in this way.

#### Designed for Stimulus-Response Test

In addition to the 24 data outputs, there are also 8 flag outputs. These depend directly on DUT status, and so can make sure that a measuring device captures the right information.

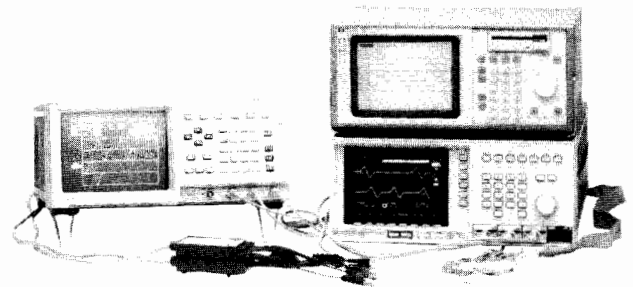

HP 8175A starts HP 1650A logic analyzer and HP 54110D oscilloscope signal capture.

#### Capture/Playback Applications

Data patterns or analog signals captured by your HP logic analyzer can be read into the HP 8175A's memory. Thus critical once-in-a-while occurrences that cause device problems are available for detailed evaluation. To help you move captured information into the HP 8175A, a program<sup>1</sup> is available that converts HP 165x(x) files to HP 8175A-readable form. The transfer can take place online via HP-IB, or offline with 3-1/2 inch disks.

#### Convenient Bench and System Implementation

Internal storage plus support of external disk drive and printer make manual setups very convenient. For automation, binary learn strings speed updates over HP-IB from the computer. In racked systems, temperatures can get fairly high; to ensure reliable results under these conditions, the HP 8175A is fully specified up to 55°C.

<sup>1</sup>This and other HP 8175A programs are available to users on request. The programs run on HP Basic 5.1 or HP Pascal 3.1 platforms. The programs are not supported.



## Built-in Editor

The HP 8175A's internal processor lets you set up counter and random patterns in a few keystrokes. It offers copy, insert, and cursor editing on tables and graphics plus special features for arbitrary waveforms<sup>2</sup>.

## Memory Segments Sequenced in Real Time

For long data sequences with repeating elements, the memory can be segmented so that only unique data need be entered. The menu below shows how the segments are set up: the first four lines produce a continuous data stream, re-using areas of memory with common data. A command from the device can cause a real-time jump to the line "TEST 2".

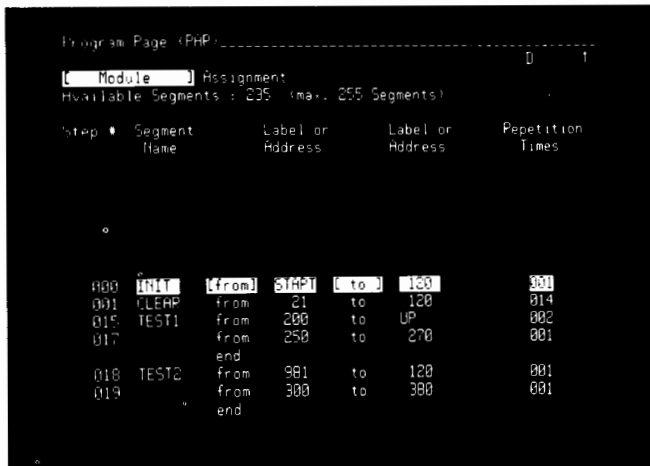

User-defined memory segments.

## Flexibility Through Bit-by-Bit Timing

Long wait periods in a data stream or constant levels in an arbitrary waveform can use many k of memory. This is seldom a problem for the HP 8175A because each data pattern or sampling point can be given its own unique duration, from 0.02  $\mu$ s up to 9.99 s.

FIGURE 1

Variable Pattern timing gives the user flexibility when programming long, asynchronous data systems. Note that the long, 10  $\mu$ s pattern is solved by a single address.

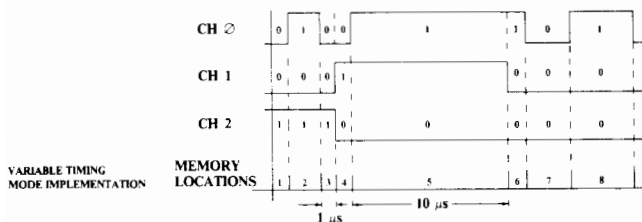

Each memory location has its own individual duration.

## Extra Clock Output for Dynamic Devices

Devices that need a continuous clock do not force you to abandon the HP 8175A's variable timing feature because a clock with independent frequency is available. It is locked to the HP 8175A master crystal so that clock and data remain synchronized.

<sup>2</sup>More information about the Option 002 arbitrary waveform generator is available on page 439.

## High-Resolution Edge Placement

All edges can be placed with 20 ns resolution. For critical clock/data or data/data adjustment, option 001 provides 100 ps resolution delay on four channels.

## Specifications

(Please request data sheet for complete specifications)

### Outputs

**Data channels:** 24, each 1024 bits.

**Max data rate:** 50 Mbit/s, NRZ format.

(If Serial Mode is selected, two 8-kbit channels are available, max data rate 100 Mbit/s, NRZ format).

**Levels:** ECL, TTL or variable-level TTL/CMOS pods. Different pods can be installed for mixed logic applications (each pod handles 8 channels). Variable level from 2.4 V to 9.9 V, programmable from HP8175A or external pod input. Fanout: 5 ECL/ 15 LSTTL/ 10/ LSTTL loads, depending on pod. Transitions: 3/ 6/ 9 ns into 22 pF, depending on pod. Tristate: implemented from HP8175A or by external signal to each pod.

**Analog channels (option 002):** 2 arbitrary waveform channels, each 10-bit vertical resolution with 1024 sample points. Max sample rate: 50 MHz.

Level ranges: 7. From 0.2 Vpp max (0.2 mV resolution) to 16 Vpp max (20 mV resolution), into 50 ohm.

Source resistance: 50 ohm.

**Flag and Clock channels:** 8 flags, or 7 flags and one clock. Flag are set by external status, see Trigger Pod. Clock period can be set from 20 ns to 99  $\mu$ s, independent of bit duration. Levels: depends on pods, see Data channels.

### Timing

**Bit duration:** 0.02  $\mu$ s to 9.99 s, individual or global.

**Resolution:** 3 digits.

**Option 001:** 100 ps independent edge positioning on four channels in a 20.0 to 40.0 ns window.

### Memory

**Size:** 24 x 1024 bit

**Segments:** as required up to 255.

**Capabilities:** Start, stop, continue, restart, jump A, jump B and loop.

### Inputs

**Trigger pod:** 8 lines to set flags and/or implement start, jump, output disable, etc.

**BNC inputs:** for external clock, external 1 MHz reference and start/stop.

## Ordering Information

**HP 8175A digital/analog stimulus** \$11,900

Note: HP 8175A must be ordered with at least one of the following options: 002, 003, 004 or 005, -or with individual pods.

**Opt 001** Fine Timing, 100 ps resolution on 4 channels +\$1,400

**Opt 002** Dual Arbitrary Waveform Generator +\$3,650

**Opt 003** 4 ECL pods Model HP 15461A and 1 Trigger pod Model HP 15463A +\$4,650

**Opt 004** 4 TTL pods Model HP 15464A and 1 Trigger pod Model HP 15463A +\$3,150

**Opt 005** 4 TTL/CMOS pods Model HP 15462A and 1 Trigger pod Model HP 15463A +\$7,050

**Opt 908** Rack Flange Kit (PN 5062-3978) +\$36

**Opt 910** Operating/Programming and Service Manual +\$290

**Opt 916** Additional Operating/Programming Manual +\$72

**Opt W30** Extended repair service. See page 723. +\$280

**HP 15430A** cable, for master/slave operation of 2 HP8175As +\$85

**HP 10062A** cover, for protecting front panel +\$75

☎For Same-day shipment, call HP-DIRECT at 800-538-8787.

# DC ELECTRONIC LOADS

## Electronic Load Family

HP 6050A - 6063A, 60501A - 60504A

- HP-IB control of current, voltage, and resistance
- HP-IB readback of current, voltage, and power
- Built-in pulse waveform generation with programmable amplitude, frequency, duty cycle and slew rate. Continuous and pulse modes
- Full protection from overpower, overtemperature, overcurrent, overvoltage and reverse polarity
- Software calibration
- Trigger for external synchronization
- Can be controlled by an analog voltage in constant current mode
- Can be paralleled in constant current mode
- Remote voltage sense in constant voltage mode
- High voltage loads now available
- Standard 3-year warranty

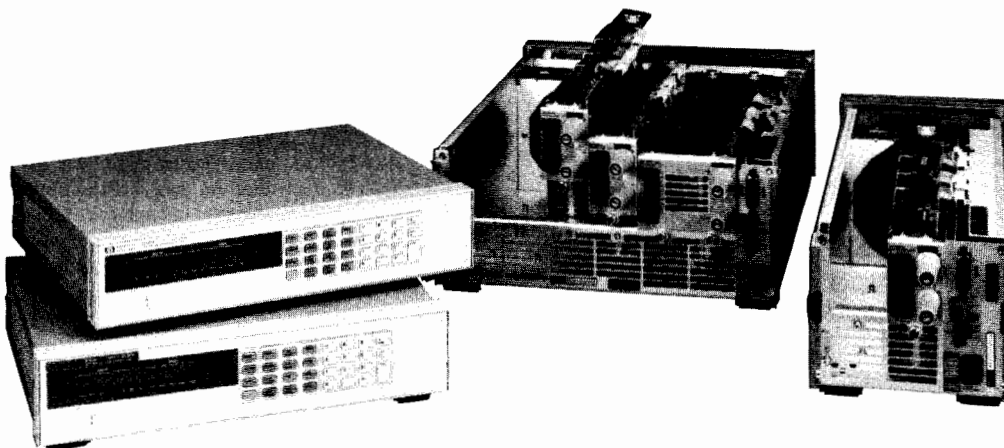

Supported by  
**HP ITG**  
Software

### HP dc Electronic Loads

Hewlett-Packard dc electronic loads are ideal for the test and evaluation of dc power sources and power components. The HP dc electronic load family offers advantages in performance, quality, and reliability. These loads are well-suited for applications in areas such as R&D, production, and incoming inspection.

### The Hewlett-Packard One-Box Solution

HP single-input loads and load mainframes are equipped with standard HP-IB interfaces. The built-in IEEE-488 interface allows complete control of all load functions as well as readback of input voltage, current, power, and detailed operating status. Each HP standalone load or load module also includes programming inputs that allow control of load current via an analog control voltage. Other system features contributing to the one-box solution concept are internal voltage and current monitors and an internal transient generator with programmable amplitudes, frequency, duty cycle and slew rate. The HP one-box solution saves space, cost, and time while making HP dc electronic loads easy to integrate into automated test systems.

### Fully Compatible Operation

The features and SCPI (equivalent to TMSL) instruction set of all HP dc electronic loads are fully compatible with one another. For example, test programs developed for an HP 6060A 300-watt single-input electronic load or an HP 60502A 300-watt single-input load module are interchangeable.

The HP dc electronic load family is also fully compatible with the HP 59510A relay accessory (see page 488). HP dc electronic loads typically have a maximum input resistance of 10,000 ohms. The HP 59510A provides physical isolation of the HP dc electronic load from the device under test or any other test instrument by switching power and sense leads. Capable of switching up to 60 amperes and 200 volts dc, the HP 59510A can be controlled by rear panel signals on the HP electronic load.

### System or Manual Applications

HP dc electronic loads are equally suitable for manual use on the bench. The front panel LCD meters indicate voltage, current and power readings. The full function front panel keypad allows easy, repeatable, and reliable control of the load when it is used manually. Six volatile user-definable states allow you to easily save settings for later recall. An additional user-definable power-up state allows you to define settings that are remembered when the unit is switched off and then recalled when it is switched on again.

### Single-Input Products

The HP 6060A and HP 6063A are single-input loads with standard rear-panel inputs. They are also available with optional front-panel inputs in addition to the rear-panel inputs. Front-panel inputs (option 020) make input connections to the HP electronic load convenient for bench applications. These front-panel terminals are capable of handling the entire current rating of the load and can accept wire gauges up to AWG #4 (22 sq mm). They require no tools to tighten, making the connections quick and easy.

### Mainframe Products

The HP 6050A 1800-watt and HP 6051A 600-watt electronic load mainframes accept the user-installable HP load modules for easy system configuration and future reconfiguration if desired. The HP 6050A holds up to six HP 60501A, 60502A, and 60503A load modules or three HP 60504A load modules, allowing up to 1800 watts total maximum power. The HP 6051A holds up to two HP 60501A, 60502A, 60503A modules or one HP 60504A module allowing up to 600 watts total maximum power. One HP-IB address is all you need for complete control and readback of all load modules within a single mainframe.

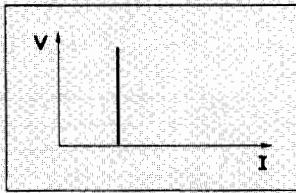
**Constant Current**

- Power Supply Load Regulation Testing
- Battery Capacity Testing
- Capacitor Discharging

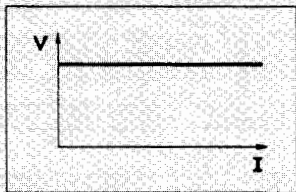
**Constant Voltage**

- Current Source Testing
- Current Limit Testing
- Shunt Regulator

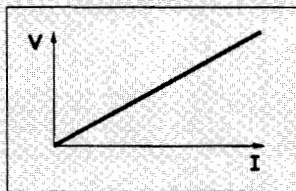
**Constant Resistance**

- Characterizing Power Supply Crossover
- Power Supply Start-up Delay
- Power Resistor Emulation

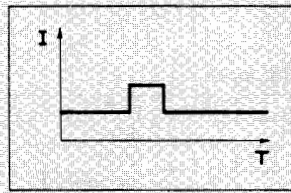
**Pulse & Dynamic Loading**

- Power Supply Load Transient Response
- Power Component Testing
- Pulse Electroplating

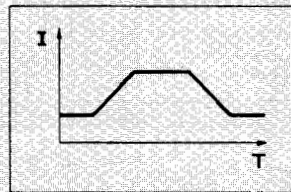
**Programmable Slew Rate**

- Power Supply Testing
- Power Component Testing
- Power Supply Load Transient Response

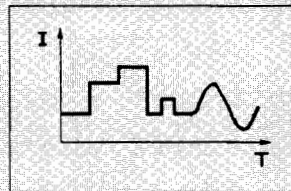
**Analog Programming**

- Battery Capacity Testing
- "Real-life" Load Simulation

**dc Electronic Load Applications  
Specifying System Performance**

Because Hewlett-Packard electronic loads feature an integrated HP-IB programmer, pulse generator, current shunt, DMM, and cabling, their performance is specified as a system. Our specifications cover all the integrated functions as one unit, which eliminates the need to calculate the actual performance of the automated test system based on each component's specification. The HP one-box solution makes the integration and documentation of your test system fast and easy.

**Operating HP Loads Below the Minimum Input Voltage Specification**

HP electronic loads meet all specifications when operated above 3.0 volts; however, the dc operating characteristics also extend below this minimum input voltage for static tests. Because of the FET technology used in the power input circuits, HP electronic loads have a low minimum input resistance allowing them to sink high currents even at low voltages.

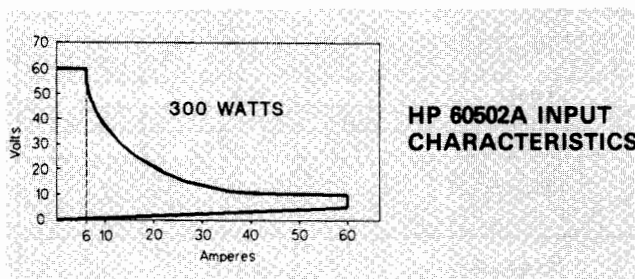

The figure above shows the operating range of a typical HP dc electronic load. Notice that low-voltage operation, completely down to 0 volts, is possible at correspondingly reduced current levels depending on the minimum resistance of the load. HP electronic loads, therefore, can be used in many applications that previously required zero volt loads.

**Why Not Make Your Own Load?**

Many load users have resorted to building their loads in-house when a commercially available electronic load with the right combination of features, power rating, performance, and purchase price could not be found. By making these loads in-house, users incur many hidden costs that can easily be overlooked. There are cost components associated with product development, parts procurement, manufacturing, product documentation, training, and product failure, maintenance or replacement. In addition, the cost components increase as the design complexity changes from simply using resistors to more sophisticated designs addressing application needs for HP-IB programming, readback, and triggering schemes for measurement synchronization.

Equipment buyers with electronic load needs have realized that the purchase price of commercially available electronic loads can be relatively insignificant when compared to the overall cost of designing, manufacturing, and maintaining them in-house.

The HP electronic load family reduces your total cost of ownership by providing superior performance, features, reliability, and complete product documentation at a reasonable purchase price. These loads allow you to use fewer resources for your electronic load test system development, and more resources to remain successful and competitive in your particular industry. The standard 3-year warranty can further reduce your maintenance costs.

The quality, performance, price, and HP support will help you make an intelligent and economical purchase decision.

# DC ELECTRONIC LOADS

## Specifications and Dimensions

### Specifications (Data Subject to Change)

	0-60 A	0-10 A	0-30 A	0-120 A
Amperes	0-60 A	0-10 A	0-30 A	0-120 A
Volts	3-60 V	3-240 V	3-60 V	3-60 V
Maximum Power (at 40°C)	300 W	250 W	150 W	600 W
Hewlett-Packard Model	HP 6060A, 60502A	HP 6063A, 60503A	HP 60501A	HP 60504A
Constant current mode Ranges	0-6 A, 0-60 A	0-1 A, 0-10 A	0-3 A, 0-30 A	0-12 A, 0-120 A
Accuracy	0.1% ±75 mA	±0.15 ±10 mA	0.1% ±40 mA	0.12% ±130 mA
Resolution	60 A range: 16 mA 6 A range: 1.6 mA	10 A range: 2.6 mA 1 A range: 0.26 mA	30 A range: 8 mA 3 A range: 0.8 mA	120 A range: 32 mA 12 A range: 3.2 mA
Temperature coefficient	100 ppm/°C ±5 mA/°C	150 ppm/°C ±1 mA/°C	100 ppm/°C ±3 mA/°C	120 ppm/°C ±8 mA/°C
Regulation	±10 mA	±8 mA	±10 mA	±10 mA
Constant voltage mode Accuracy	0.1% ±50 mV	±0.12% ±120 mV	0.1% ±50 mV	0.1% ±50 mV
Resolution	16 mV	64 mV	16 mV	16 mV
Regulation	±10 mV	±10 mV	±5 mV	±20 mV
Temperature coefficient	100 ppm/°C ±5 mV/°C	120 ppm/°C ±10 mV/°C	100 ppm/°C ±5 mV/°C	100 ppm ±5 mV/°C
Constant resistance mode Ranges	0.033 - 1.0 Ω 1 Ω - 1KΩ 10 Ω - 10 KΩ	0.20 - 24.0 ohm 24 - 1000Ω 240 - 5000Ω	0.067 - 2 Ω 2 Ω - 2 K Ω 20 Ω - 10 KΩ	0.017 - 0.5 Ω 0.5 Ω - 500 Ω 5 Ω - 5 KΩ
Accuracy	1 Ω: 0.8% ±8 mΩ (with ≥6A at input) 1 K Ω: 0.3% ±8 mS (with ≥6V at input) 10 K Ω: 0.3% ±8 mS (with ≥6V at input)	24Ω: 0.8% ±200 mΩ (with ≥1A at input) 10 KΩ: 0.3% ±0.3 mS (with ≥24V at input) 50 KΩ: 0.3% ±0.3 mS (with ≥24V at input)	2 Ω: 0.8% ±16 mΩ (with ≥3A at input) 2 KΩ: 0.3% ±5 mS (with ≥6V at input) 10 KΩ: 0.3% ±5 mS (with ≥6V at input)	0.5 Ω: 0.8% ±5 mΩ (with ≥12A at input) 500 Ω: 0.3% ±16 mS (with ≥6V at input) 5 KΩ: 0.3% ±16 mS (with ≥6V at input)
Resolution	1 Ω: 0.27 mΩ 1 KΩ: 0.27 mS 10 KΩ: 0.027 mS	24Ω: 6 mΩ 10 KΩ: 0.011 mS 50 KΩ: 0.001 mS	2 Ω: 0.54 mΩ 2 KΩ: 0.14 mS 10 KΩ: 0.014 mS	5 Ω: 0.14 mΩ 500 Ω: 0.54 mS 5 KΩ: 0.054 mS
Regulation	1 Ω: 10 mV 1 KΩ: 10 mA 10 KΩ: 10 mA	24Ω: 10 mV 10 KΩ: 8 mA 50 KΩ: 8 mA	2 Ω: 10 mV 2 KΩ: 10 mA 10 KΩ: 10 mA	5 Ω: 20 mV 500 Ω: 10 mA 5 KΩ: 10 mA
Temperature coefficient	1 Ω: 800 ppm/°C ±0.4 mΩ/°C 1 KΩ: 300 ppm/°C ±0.6 mS/°C 10 KΩ: 300 ppm/°C ±0.6 mS/°C	24 Ω: 800 ppm/°C 800 ppm/°C ±10 mΩ/°C 10 KΩ: 300 ppm/°C 300 ppm/°C ±0.03 mS/°C 50 KΩ: 300 ppm/°C 300 ppm/°C -0.03 mS/°C	2 Ω: 800 ppm/°C ±0.8 mΩ/°C 2 KΩ: 300 ppm/°C ±0.5 mS/°C 10 KΩ: 300 ppm/°C ±0.5 mS/°C	0.5 Ω: 800 ppm/°C ±0.2 mΩ/°C 500 Ω: 300 ppm/°C ±1.2 mS/°C 5 KΩ: 300 ppm/°C ±1.2 mS/°C
Transient generator Frequency range	0.25 Hz - 10 kHz	0.25 Hz - 10 kHz	0.25 Hz - 10 kHz	0.25 Hz - 10 kHz
Resolution	4% or less	4% or less	4% or less	4% or less
Accuracy	3%	3%	3%	3%
Duty cycle range	3 - 97% (0.25 Hz - 1 kHz) 6 - 94% (1 kHz - 10 kHz)	3%-97% (0.25 Hz - 1 kHz) 6-94% (1 kHz - 10 kHz)	3 - 97% (0.25 Hz - 1 kHz) 6 - 94% (1 kHz - 10 kHz)	3 - 97% (0.25 Hz - 1 kHz) 6-94% (1 kHz - 10 kHz)
Resolution	4%	4%	4%	4%
Accuracy	6% of setting ±2%	6% of setting ±2%	6% of setting ±2%	6% of setting ±2%
Current level high range Resolution	60 A range: 260 mA	10 A range: 43 mA	30 A range: 130 mA	120 A range: 520 mA
Accuracy	0.1% ±350 mA	0.18% ±50 mA	0.1%, ±200 mA	0.15% ±700 mA
Current level low range Resolution	6 A range: 26 mA	1 A range: 4 mA	3 A range: 13 mA	12 A range: 52 mA
Accuracy	0.1% ±80 mA	0.18% ±13 mA	0.1% ±40 mA	0.15% ±160 mA
Current temperature coefficient	100 ppm/°C ±7 mA/°C	180 ppm/°C ±1.2 mA/°C	100 ppm ±5 mA/°C	150 ppm/°C ±10 mA/°C
Voltage level	3 to 60 V	3 - 240 V	3 to 60 V	3 to 60 V
Voltage level resolution	260 mV	1 V	260 mV	260 mV
Voltage level accuracy	0.1% ±300 mV	0.15% ±1.1 V	0.1% ±300 mV	0.15% ±300 mV
Net weight (approx.)	6060A: 6.4 kg (14 lb) 60502A: 3.2 kg (7 lb)	6063A: 6.4 kg (14 lb) 60503A: 3.2 kg (7 lb)	3.2 kg (7 lb)	5.9 kg (13 lb)
Shipping weight	6060A: 7.5 kg (17 lb) 60502A: 4.5 kg (10 lb)	6063A: 7.5 kg (17 lb) 60503A: 4.5 kg (10 lb)	4.5 kg (10 lb)	7.3 kg (16 lb)

#### HP 6050A, 6051A weight

Net Weight: 6050A: 9.5 kg (21 lb)  
6051A: 5.5 kg (12 lb)  
Shipping Weight: 6050A: 13.6 kg (30 lb)  
6051A: 7.5 kg (17 lb)

#### HP-IB interface capabilities

The following HP-IB functions are implemented: SH1, AH1, L4, SR1, DC1, DT1, and RL1

#### Safety agency compliance

Hewlett-Packard Electronic Loads are designed to comply with the following regulatory standards: IEC 348, VDE 0411, UL 1244, and CSA Electrical Bulletin 556B



Specifications - continued

Hewlett-Packard Model	HP 6060A, 60502A	HP 6063A, 60503A	HP 60501A	HP 60504A
<b>Transient generator (continued)</b>				
Voltage temperature coefficient	150 ppm/°C ± 5 mV/°C	120 ppm/°C ± 10 mV/°C	150 ppm/°C ± 5 mV/°C	150 ppm/°C ± 5 mV/°C
Programmable slew rate	60 A range: 1 A/ms - 5 A/μs 6 A range: 0.1 A/ms - 0.5 A/μs	10 A Range: 0.17 A/ms - 0.83 A/μs 1 A range: 17 A/s - 83 A/ms	30 A Range: 0.5 A/ms - 2.5 A/μs 3 A range: 0.05 A/ms - 0.25 A/μs	120 A range: 2 A/ms - 10A/μs 12 A range: 200 A/s - 1 A/μs
Rise/fall time	12 μs to 8 ms	16 μs to 8 ms	12 μs - 8 ms	12 μs - 8 ms
<b>Analog programming bandwidth</b>	10 kHz (-3 db freq.)	10 kHz (-3 db freq.)	10 kHz (-3 db freq.)	10 kHz (-3 db freq.)
<b>Analog programming accuracy</b>				
Current (low range)	4.5% ± 75 mA	3% ± 8 mA	4.5% ± 40 mA	4% ± 200 mA
Current (high range)	4.5% ± 250 mA	3% ± 12 mA	4.5% ± 130 mA	4% ± 400 mA
Temperature coefficient	100 ppm/°C ± 6 mA/°C	150 ppm/°C ± 1 mA/°C	100 ppm/°C ± 3 mA/°C	100 ppm/°C ± 12 mA/°C
Voltage	0.8% ± 200 mV	0.5% ± 150 mV	0.8% ± 200 mV	0.8% ± 200 mV
Temperature coefficient	100 ppm/°C ± 1 mV/°C	120 ppm/°C ± 10 mV/°C	100 ppm/°C ± 1 mV/°C	100 ppm/°C ± 1 mV/°C
<b>Analog programming voltage</b>	0-10 V	0-10 V	0-10 V	0-10 V
<b>Readback specifications</b>				
current readback resolution	17 mA (via HP-IB) 20 mA (front panel)	2.7 mA (via HP-IB) 10 mA (front panel)	9 mA (via HP-IB) 10 mA (front panel)	32 mA (via HP-IB) 100 mA (front panel)
Current readback accuracy	0.05% ± 65 mA	0.12% ± 10 mA	0.06% ± 40 mA	0.1% ± 110 mA
Temperature coefficient	50 ppm/°C ± 5 mA/°C	100 ppm/°C ± 1 mA/°C	65 ppm/°C ± 3 mA/°C	100 ppm/°C ± 8 mA/°C
Voltage readback resolution	17 mV (via HP-IB) 20 mV (front panel)	67 mV (via HP-IB) 100 mV (front panel)	17 mV (via HP-IB) 20 mV (front panel)	16 mV (via HP-IB) 20 mV (front panel)
Voltage readback accuracy	0.05% ± 45 mV	0.1% ± 150 mV	0.05% ± 45 mV	0.1% ± 45 mV
Temperature coefficient	50 ppm/°C ± 1.2 mV/°C	100 ppm/°C ± 8 mV/°C	50 ppm/°C ± 1.2 mV/°C	100 ppm/°C ± 2 mV/°C
Power readback accuracy	0.2% ± 4 W	0.2% ± 3 mV	0.2% ± 2 W	0.2% ± 8 W
<b>Analog monitor accuracy</b>				
Current monitor (0 to 10 V out)	4% ± 85 mA	3% ± 10 mA	4% ± 40 mA	4% ± 170 mA
Temperature coefficient	50 ppm/°C ± 6 mA/°C	100 ppm/°C ± 1 mA/°C	60 ppm/°C ± 3 mA/°C	100 ppm/°C ± 10 mA/°C
Voltage monitor (0 to 10 V out)	0.25% ± 40 mV	0.4% ± 240 mV	0.25% ± 40 mV	0.4% ± 60 mV
Temperature coefficient	50 ppm/°C ± 0.2 mV/°C	70 ppm/°C ± 1.2 mV/°C	50 ppm/°C ± 0.2 mV/°C	100 ppm/°C ± 2 mV/°C
<b>Remote sensing</b>	5 Vdc maximum between sense and load input			
<b>Minimum operating voltage</b>	2 volts (typical 1.2 V)	2 volts (typical 1.2 V)	2 volts (typical 1.2 V)	2 volts (typical 1.4 V)
<b>Programmable short</b>	0.033 Ω (0.020 typical)	0.20 Ω (0.10 typical)	0.066 Ω (0.040 typical)	0.017 Ω (0.012 typical)
<b>Programmable open (typical)</b>	20 KΩ (typical)	80 KΩ (typical)	20 KΩ (typical)	20 KΩ (typical)
<b>Drift (over 8 hour interval)</b>				
Current	0.03% ± 10 mA	0.03% ± 15 mA	0.03% ± 5 mA	0.03% ± 20 mA
Voltage	0.01% ± 10 mV	0.01% ± 20 mV	0.01% ± 10 mV	0.01% ± 10 mV
<b>PARD (20 Hz to 10 MHz noise)</b>				
Current	4 mA rms 40 mA peak-peak	1 mA rms 10 mA peak-peak	2 mA rms 20 mA peak-peak	6 mA rms 60 mA peak-peak
Voltage	6 mV rms	6 mV rms	5 mV rms	8 mV rms
<b>dc solution voltage</b>	±240 Vdc. between any input and chassis ground			
<b>Digital inputs</b>	V <sub>IL</sub> = 0.9 V max at I <sub>IL</sub> = -1 mA V <sub>IH</sub> = 3.15 V min (pull-up resistor on input)			
<b>Digital outputs</b>	V <sub>OL</sub> = 0.72 V max at I <sub>OL</sub> = 1 mA V <sub>OH</sub> = 4.4 V min at I <sub>OH</sub> = -20 μA			

- Notes:  
 1. Operating temperature range is 0 to 55°C. All specifications apply for 25°C ± 5°C, except as noted.  
 2. Maximum continuous power available is derated linearly from 40°C to 75% of maximum at 55°C.  
 3. dc current accuracy specifications apply 30 seconds after input is applied.

Ordering Information

Model	Price	Options							
		Front Panel Inputs	ac Input			Rackmount Kit			Extra Manuals
			100 VAC Japan Only	220 VAC	240 VAC	800	908	909	
HP 6050A	\$1,920	-	\$0*	\$0*	\$0*	-	+\$37†	+\$98†	+\$52*
HP 6051A	\$1,700	-	\$0*	\$0*	\$0*	-\$67†	+\$67†	-	+\$50*
HP 6060A	\$2,100	+\$82*	\$0*	\$0*	\$0*	-	+\$32*	+\$75*	+\$35*
HP 6063A	\$2,500	+\$82*	\$0*	\$0*	\$0*	-	+\$32*	+\$75*	+\$35*
HP 60501A	\$1,315	-	-	-	-	-	-	-	+\$32*
HP 60502A	\$1,620	-	-	-	-	-	-	-	+\$32*
HP 60503A	\$1,950	-	-	-	-	-	-	-	+\$32*
HP 60504A	\$2,275	-	-	-	-	-	-	-	+\$32*

† Option 908 and 909 for the HP 6050A, and Option 800 and 908 for the HP 6051A, require either the slide kit (P/N 1494-0059) or slide rails to support the weight of the load mainframe. Slide kits can be purchased using the above part number.  
 \* This feature is available as an option.  
 - This feature is not available.

Option Descriptions

- Opt 020** Front panel inputs.
- Opt 100** 87-106 Vac, 47-66 Hz (for Japan only).
- Opt 220** 191-233 Vac, 47-66 Hz.
- Opt 240** 209-250 Vac, 47-66 Hz.
- Opt 800** Rackmounting kit for two units mounted side-by-side. (HP part numbers 5062-3994 and 5062-3978).
- Opt 908** Rackmounting kit includes (HP P/N 5062-3978 with an HP 6050A, HP P/N 5062-3960 with HP 6051A, and HP P/N 5062-3974 with an HP 6060A).
- Opt 909** Rackmounting kit with handles (HP P/N 5062-3984 when mounting an HP 6050A and HP P/N 5062-3975 when mounting an HP 6060A).
- Opt 910** Extra manual set, including one each of the Operating Manual, Programming Reference Manual, and Service Manual. The Programming Manual is available with the Mainframe, and therefore not individual modules. (Operating Manuals and Programming Manuals only are shipped with standard units).

# POWER SUPPLIES

## General Information

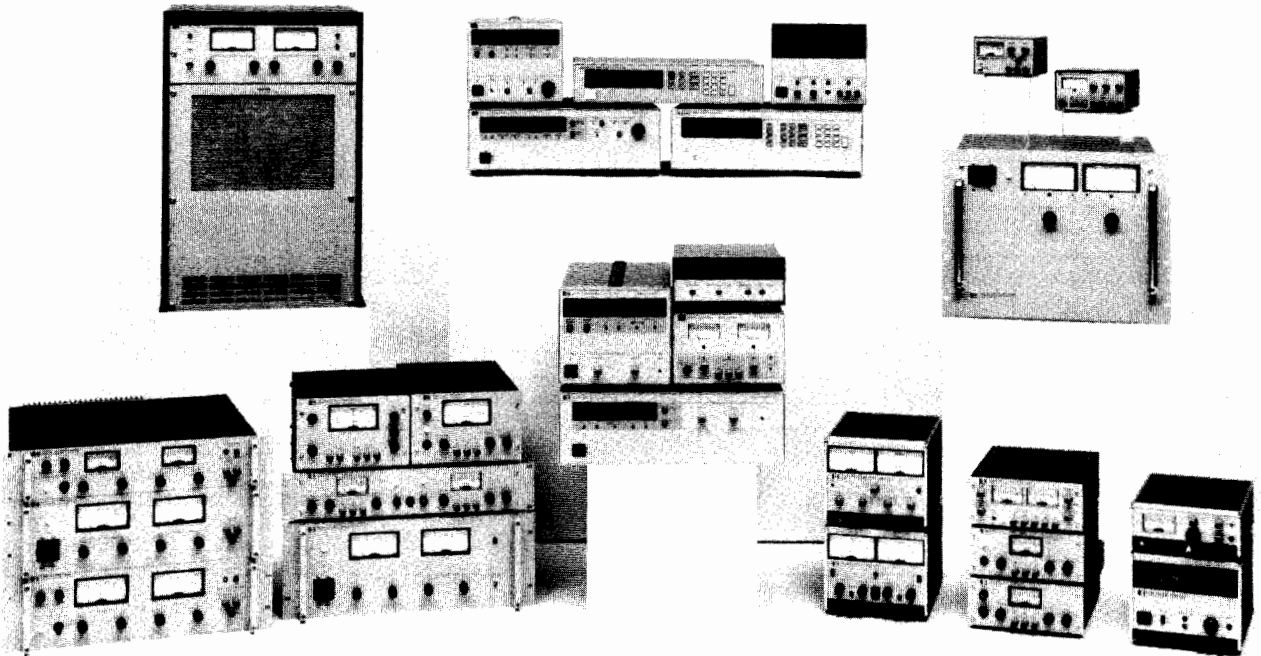

### Introduction

Hewlett-Packard's extensive variety of power supplies serve a wide range of applications, in research and development, industrial applications, and computer automated test systems. All power supplies are designed for high reliability and ease of use. Hewlett-Packard provides advanced capabilities through innovative technology.

### Power Supply Selection Tables - Page 472

There are three selection tables

- HP-IB Programmable Power Supplies
- Analog Programmable Power Supplies
- Laboratory Bench and Special Purpose Power Supplies

Choose the table that most closely fits your requirements. Each table is structured in ascending order of maximum output voltage. Upon selection of a model which fits your needs reference the appropriate page number for further information. If you are unsure of a selection or require additional information contact the nearest Hewlett-Packard sales office. A complete listing of Hewlett-Packard sales offices can be found toward the rear of this catalog.

### The "One-Box" Solution

Hewlett-Packard has power supplies which can be remotely programmed via resistance, voltage, or directly through the HP-IB. The new "One-Box" Solution system power supplies (HP models 6030A-6038A, 6621A-6629A, 6632A-6634A, 6651A-6655A) have built-in HP-IB programmers for voltage and current. Also included is a built-in DVM and precision current shunt for measured read-back of voltage and current via the HP-IB.

### New 1990/91 Power Supply Catalog

For more details concerning Hewlett-Packard power supplies, ask your HP sales representative for a DC Power Supply Catalog, or fill in the card at the rear of this catalog.

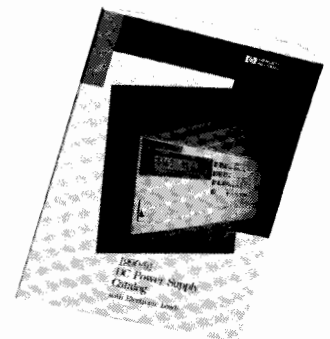

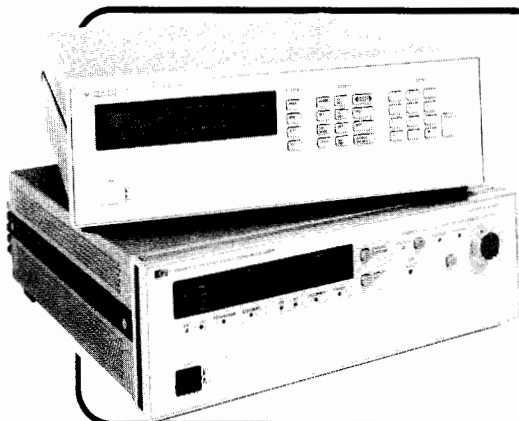

### HP-IB Programmable Power Supplies Pages 478 to 491

- 500 Watt Single Output
- 100 Watt Single Output
- Multiple Output
- Precision Multiple Output
- 200 and 1000 Watt Autoranging
- HP-IB Programmer for Analog Programmable Power Supplies

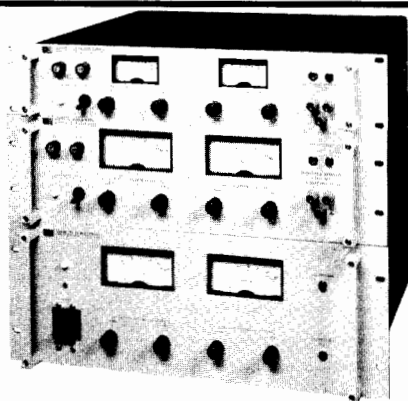

### Analog Programmable Power Supplies Pages 492 to 499

- General Purpose 25-200 Watt
- 200 and 1000 Watt Autoranging
- General Purpose 200-2000 Watt
- General Purpose 300-11,000 Watt

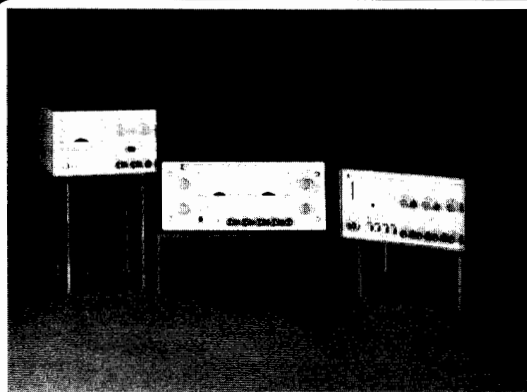

### Laboratory Bench Power Supplies Page 500 to 502

- Single Output Bench
- Dual Output Bench
- Triple Output Bench

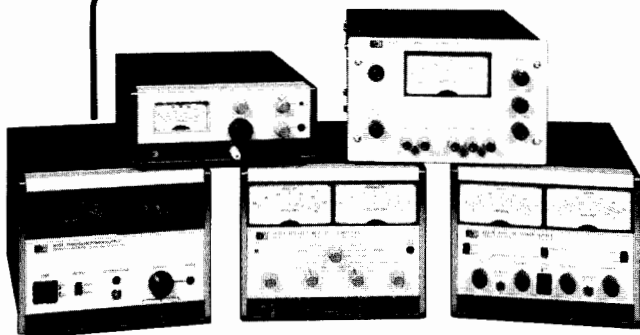

### Special Purpose Power Supplies Pages 503 to 505

- Bipolar/Amplifiers
- Precision Voltage and Current Sources

# POWER SUPPLIES

## Voltage Rating Index



### HP-IB Programmable Supplies

All models listed in the tables on this page feature built-in HP-IB for direct voltage and current programming, as well as actual voltage and current readback.

#### Single Output HP-IB Power Supplies - 100 W to 1000 W

Max Volts (dc)	Max Amps (dc)	Type	HP Model Number	Page
6.7	30	Autoranging	HP 6033A	486
7	120	Autoranging	HP 6031A	486
8	50	Linear	HP 6651A	478
±10	0.01	DAC Programmer*	HP 59501B	491
20	5	Linear	HP 6632A	480
20	10	Autoranging	HP 6033A	486
20	10	Autoranging	HP 6038A	486
20	10	High Performance Autoranging	HP 6002A†	490
20	25	Linear	HP 6652A	478
20	50	Autoranging	HP 6031A	486
20	50	Autoranging	HP 6032A	486
35	15	Linear	HP 6653A	478
50	2	Linear	HP 6633A	491
50	4	High Performance Autoranging	HP 6002A†	490
60	3.3	Autoranging	HP 6038A	486
60	9	Linear	HP 6654A	478
60	17	Autoranging	HP 6030A	486
60	17.5	Autoranging	HP 6032A	486
100	1	Linear	HP 6634A	491
120	4.5	Linear	HP 6655A	478
200	5	Autoranging	HP 6030A	486
200	5	Autoranging	HP 6035A	486
500	2	Autoranging	HP 6035A	486

\*No readback †Must be ordered with Option 001 for HP-IB control; no readback

#### Multiple Output HP-IB Power Supplies — 25 W to 80 W (all models included here are linear designs)

HP Model Number	40 W		80 W		Precision		Page	
	Low Range High Range	7 V, 5 A 20 V, 2 A	20 V, 2 A 50 V, 0.8 A	7 V, 10 A 20 V, 4 A	20 V, 4 A 50 V, 2 A	25 W		50 W
						7V, 15 mA 5 V, 500 mA		16 V, 200 mA 50 V, 1 A
HP 6621A	—	—	—	2	—	—	482	
HP 6622A	—	—	—	—	2	—	482	
HP 6623A	1	1	1	—	—	—	482	
HP 6624A	2	2	—	—	—	—	482	
HP 6625A	—	—	—	—	1	1	484	
HP 6626A	—	—	—	—	2	2	484	
HP 6627A	—	4	—	—	—	—	482	
HP 6628A	—	—	—	—	—	2	484	
HP 6629A	—	—	—	—	—	4	484	



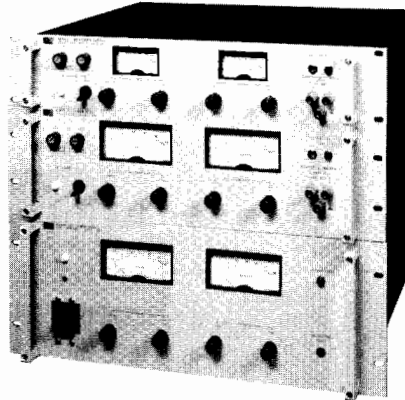

### Analog Programmable Supplies

All models listed in this table are programmable either with an analog voltage or resistance signal. For lab bench applications where analog programming is not required, also consider the Lab Bench Power Supplies listed on page 474.

Max Volts (dc)	Max Amps (dc)	Type	HP Model Number	Page
6.7	30	Autoranging	HP 6023A	494
7	120	Autoranging	HP 6011A	494
7.5	5	CV/CC	HP 6281A	492
8	1000	CV/CC	HP 6464C	498
10	10	CV/CC	HP 6282A	492
10	50	CV/CC	HP 6259B	496
10	100	CV/CC	HP 6260B	496
15	200	CV/CC	HP 6453A	498
16	600	CV/CC	HP 6466C	498
18	500	CV/CC	HP 6466C	498
20	0.6	Dual Output (20 V, 20 V)	HP 6205C	500
20	1.5	CV/CC	HP 6200B	500
20	2	Precision Voltage	HP 6114A	504
±20	±2	Bipolar PSA	HP 6825A	503
20	3	CV/CC	HP 6284A	492
20	3	Dual Output (20 V, 20 V)	HP 6253A	492
20	10	Autoranging	HP 6023A	494
20	10	Autoranging	HP 6024A	494
20	10	CV/CC	HP 6263B	496
20	10	CV/CC	HP 6286A	492
20	20	CV/CC	HP 6264B	496
20	50	Autoranging	HP 6011A	494
20	50	Autoranging	HP 6012B	494
20	50	CV/CC	HP 6261B	496
25	2	Dual Output (25 V, 25 V)	HP 6227B	492
30	1	CV/CL	HP 6206B	500
36	100	CV/CC	HP 6456B	498
36	300	CV/CC	HP 6469C	498
40	0.3	Dual Output (40 V, 40 V)	HP 6205C	500
40	0.75	CV/CC	HP 6200B	500
40	1	Precision Voltage	HP 6114A	504
40	1.5	CV/CC	HP 6289A	492
40	1.5	Dual Output (40 V, 40 V)	HP 6255A	492
40	5	CV/CC	HP 6266B	496
40	5	CV/CC	HP 6291A	492

Max Volts (dc)	Max Amps (dc)	Type	HP Model Number	Page
40	5.7	Autoranging	HP 6024A	494
40	10	CV/CC	HP 6267B	496
40	25	CV/CC	HP 6434B	498
40	30	Autoranging	HP 6012B	494
40	30	CV/CC	HP 6268B	496
40	50	CV/CC	HP 6269B	496
50	0.5	Precision Current	HP 6177C	505
50	0.8	Precision Voltage	HP 6115A	504
50	1	Dual Output (50 V, 50 V)	HP 6228B	492
±50	±1	Bipolar PSA	HP 6826A	503
60	0.5	CV/CL	HP 6206B	500
60	1	CV/CC	HP 6294A	492
60	3	CV/CC	HP 6296A	492
60	3.3	Autoranging	HP 6024A	494
60	15	CV/CC	HP 6274B	496
60	17	Autoranging	HP 6010A	494
60	17.5	Autoranging	HP 6012B	494
64	50	CV/CC	HP 6459A	498
64	150	CV/CC	HP 6472C	498
100	0.25	Precision Current	HP 6181C	505
100	0.4	Precision Voltage	HP 6115A	504
±100	±0.5	Bipolar PSA	HP 6827A	503
100	0.75	CV/CC	HP 6299A	492
110	100	CV/CC	HP 6475C	498
200	5	Autoranging	HP 6010A	494
200	5	Autoranging	HP 6015A	494
220	50	CV/CC	HP 6477C	498
300	0.1	Precision Current	HP 6186C	505
300	35	CV/CC	HP 6479C	498
320	0.1	CV/CC	HP 6209B	500
440	25	CV/CC	HP 6483C	498
500	2	Autoranging	HP 6015A	494
500	20	CV/CC	HP 6483C	498
600	1.5	CV/CC	HP 6448B	498
600	15	CV/CC	HP 6483C	498

# POWER SUPPLIES

## Voltage Rating Index (cont'd)

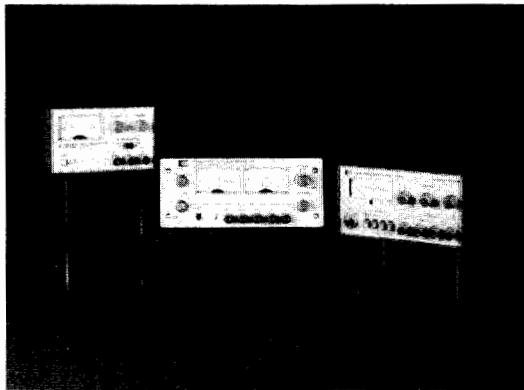

Laboratory Bench Power Supplies

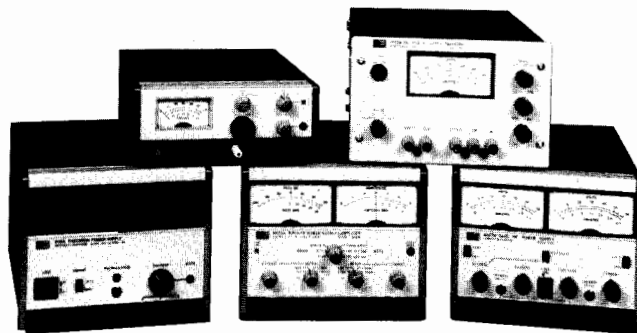

Special Purpose Power Supplies

### Lab Bench Power Supplies

Type	Max Volts (dc)	Max Amps (dc)	HP Model Number	Page
Single Output	10	1	HP 6214C	500
	25	0.4	HP 6216C	500
	50	0.2	HP 6218C	500
	100	0.1	HP 6212C	500
Dual Output	25 V	0.2	HP 6234A	500
	25 V	0.2		
Triple Output	6 V	1	HP 6235A	500
	$\pm 18$ V	0.2		
	6 V	2.5	HP 6236A	500
	$\pm 20$ V	0.5		
Triple Output	18 V	1	HP 6237A	500
	$\pm 20$ V	0.5		

### Special Purpose Power Supplies

Type	Max Volts (dc)	Max Amps (dc)	HP Model Number	Page
Bipolar Amplifier	$\pm 20$	$\pm 2$	HP 6825A	503
	$\pm 50$	$\pm 1$	HP 6826A	503
	$\pm 100$	$\pm 0.5$	HP 6827A	503
Precision Voltage	20	2	HP 6114A	504
	40	1	HP 6114A	504
	50	0.8	HP 6115A	504
	100	0.4	HP 6115A	504
Precision Current	50	0.5	HP 6177C	505
	100	0.25	HP 6181C	505
	300	0.1	HP 6186C	505

- Modification of maximum output voltage or current.
- Customization of front panel paint, panel markings, or silk screening of logos or other special characters.
- Improvement of a specific performance specifications such as PARD, accuracy, resolution, programming speed, etc.

### Power Products Modification Service

Although HP power supplies are intended to satisfy a wide range of applications, the standard products might not match all needs. To solve specific power supply problems, Hewlett-Packard offers a special modification service. This service entails the design and manufacture of modified versions of standard catalog models of dc power supplies and electronic loads.

Modified products are designed, manufactured, tested, and supported to the same high quality and reliability standards as other HP products. Any changes in the manufacturing processes are well documented in the factory. Any necessary updates are also provided for the operating and service literature.

By taking advantage of Hewlett-Packard's engineering expertise to address your special power supply needs, you can allow your engineering staff to focus on your main business. The associated engineering costs can be amortized over a number of units, contingent on volume commitment and other project specifics.

OEM customers find the modification services particularly valuable when integrating power supplies into their final products. Although the scope of this service is usually limited to the modification of standard products, HP engineers welcome discussion to determine the feasibility of meeting particular requirements.

- Variable fan speed control.

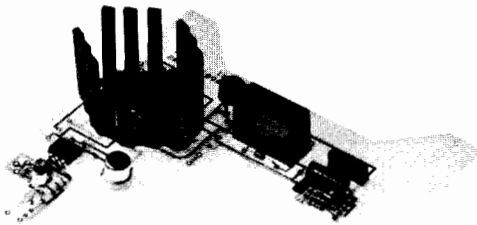

HP 601XA, 602XA, 603XA-J10: This modification allows the power supply fan to operate at slower, quieter speeds under conditions when less cooling is needed.

For more information about the Power Products Modification Service, or any of the modified products described above, contact your local HP Sales Office.

- Alteration of a control loop's compensation in order to accommodate a highly reactive load.
- Alteration of a control loop's compensation for use as a power amplifier or in a closed loop application on some parameter other than output V or I.
- Rack and stack power products system.

### The Modification Process

The basic steps of the modification process are as follows:

- Contact your local Hewlett-Packard sales office and discuss your power supply and/or electronic load needs with a sales representative.
- The sales representative submits your request for quote to the power products engineering staff.
- Communication begins between you and an HP power products application engineer. This direct line of communication continues throughout the project, to make sure that the design meets your needs.
- Your sales representative quotes a price based on proposed engineering design changes, production cost, and estimated quantity.
- You submit an order, letter of intent, or other contractual agreement appropriate for the project, as agreed with Hewlett-Packard.
- The modified product is designed, then prototypes are built and evaluated.
- HP provides a prototype for your evaluation, based on previous agreement and complexity of modification.
- Hewlett-Packard writes manufacturing and service documentation, and any user literature necessary.
- The modified product is produced, and future production quantities are scheduled based on your requirements.
- Auxiliary outputs.

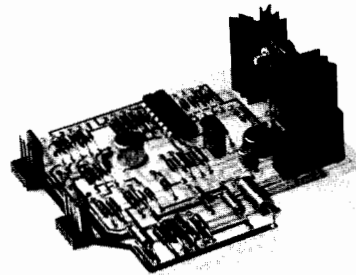

HP 6031A-JO7: This modification provides an auxiliary 5 V output.

# POWER SUPPLIES

## Power Supply Terms and Specification Definitions

### Power Supply Terms

**Ambient temperature:** the temperature of the air immediately surrounding the power supply.

**Auto-parallel operation:** a master-slave connection of the outputs of two or more supplies used for obtaining a current output greater than can be obtained from one supply.

**Autoranging power supply:** a power supply that can provide maximum rated power over a wide range of voltage and current without external intervention to change range.

**Auto-series operation:** a master-slave connection of the outputs of two or more supplies used for obtaining a voltage greater than can be obtained from one supply.

**Auto-tracking operation:** a master-slave connection of two or more supplies each of which has one of its output terminals in common with one of the output terminals of all of the other supplies.

**Complementary tracking:** a master-slave interconnection of two supplies in which the voltage of the slave is equal to or proportional to that of the master and of opposite polarity with respect to a common point.

**Compliance voltage:** the output voltage of a power supply operating in the constant-current mode.

**Constant-current (CC) power supply:** a power supply that stabilizes output current with respect to changes in influence quantities. Thus, for a change in load resistance, the output current remains constant while the output voltage changes by whatever amount necessary to accomplish this.

**Constant-voltage (CV) power supply:** a power supply that stabilizes output voltage with respect to changes in influence quantities. Thus, for a change in load resistance, the output voltage remains constant while the output current changes by whatever amount necessary to accomplish this.

**Constant-voltage/constant-current (CV/CC) power supply:** a power supply that operates as a constant voltage power supply or a constant-current power supply depending on load conditions. It acts as a constant-voltage source for comparatively large values of load resistance and as a constant-current source for comparatively small values of load resistance.

**Constant-voltage/current-limiting (CV/CL) power supply:** a power supply similar to a constant-voltage/constant-current supply except that at comparatively small values of load resistance, its output current is limited instead of being stabilized.

**Crowbar:** see overvoltage protection.

**Current limiting:** the action of limiting the output current of a constant-voltage supply to some predetermined maximum value (fixed or adjustable) and automatically restoring the output voltage to its normal value when the overload or short circuit is removed. There are three types of current limiting: 1) by constant-voltage/constant-current crossover, 2) by decreasing the output voltage as the current increases, 3) by decreasing both voltage and current as the load resistance decreases (referred to as foldback or cutback current limiting).

**Drift:** the maximum change of an output voltage or current during an 8-hour period following a 30-minute warmup, with all influence and control quantities maintained constant during the warm-up time and the period of drift measurement. Drift includes both periodic and random deviations over the bandwidth from zero frequency (dc) to a specified upper frequency limit (usually 20 Hz).

**Load effect:** formerly known as load regulation, load effect is the change in the steady-state value of the stabilized output voltage or current resulting from a full-load change in the load current of a constant-voltage supply or the load voltage of a constant-current supply, with all other influence quantities maintained constant.

**Load effect transient recovery time:** the time interval between a specified step change in the load current of a constant-voltage supply (usually a full-load or 5-ampere change, whichever is smaller) or in the load voltage of a constant-current supply and the instant when the stabilized output quantity returns to and stays within the specified transient recovery band.

**Master-slave operation:** a method of interconnecting two or more supplies such that one of them (the master) serves to control the others (the slaves). The outputs of the slave supplies always remain equal to or proportional to the output of the master. The outputs of

the master supply and of one or more slaves may be connected in series, in parallel, or with just their negative or positive output terminals in common. (See also complementary tracking.)

**Nominal value:** the value that exists "in name only," not the actual value. For example, in the case of a power supply with a calibrated output control, the nominal value is the value indicated by the control setting. For a supply with a fixed output, the nominal output is the output indicated on the nameplate. The nominal value of a 120-volt  $\pm$  10% line voltage is 120 volts.

**Output impedance:** the complex ratio of a sinusoidal voltage and sinusoidal current at the output terminals, the one being caused by the other and being of external origin.

**Overcurrent protection:** protection of the power supply and/or connected equipment against excessive output current.

**Overtemperature protection:** protection of the power supply or parts of it against temperatures exceeding specified values.

**Overvoltage protection:** protection of the power supply and/or connected equipment against excessive output voltage. Overvoltage protection is usually by means of a crowbar protection circuit, which rapidly places a low resistance shunt across the supply's output terminals to reduce output voltage to a low value if a predetermined voltage is exceeded. A supply equipped with an overvoltage crowbar must also be protected by a means of limiting or interrupting output current.

**PARD (acronym for periodic and random deviation):** the term PARD replaces the former term ripple and noise. PARD is the periodic and random deviation of a dc output voltage or current from its average value, over a specified bandwidth (20 Hz to 20 MHz) and with all influence and control quantities maintained constant.

**Programming speed:** the maximum time required for the programmed output voltage or current to change from a specified initial value (usually zero or maximum output) to a value within a specified tolerance band of a specified newly programmed value (for most models 99.9% or 0.1% of maximum output, respectively; 99% and 1% for the HP 6114A, 6115A, 6177C-6186C, and HP 6434B-6483C) following the onset of a step change in an analog programming signal, or the gating of a digital signal.

**Remote control:** also referred to as remote programming, remote control is the setting of the power supply voltage, current, or other function by means of an external control quantity such as a variable resistance, voltage, or current, or a digital signal.

**Remote sensing:** remote sensing, or remote error sensing, is a means by which a power supply monitors the stabilized voltage directly at the load using extra sensing leads. The resulting circuit action compensates for voltage drops in the load leads (up to a specified limit).

**Resolution:** for a bench supply, the smallest change in output voltage or current that can be obtained using the front panel controls. For a system supply, the smallest change that can be obtained using either the front panel controls or a computer.

**Reverse voltage protection:** protection of the power supply against reverse voltage applied at the output terminals.

**Slave operation:** see master-slave operation.

**Source effect:** formerly known as line regulation, source effect is the change in the steady-state value of the stabilized output voltage on current resulting from any change in the source voltage within its specified range, with all other influence quantities maintained constant. Source effect may be measured at any output voltage and current within rating.

**Temperature effect coefficient:** the maximum steady-state change in a power supply's output voltage or current per degree Celsius following a change in the ambient temperature within specified limits, with all other influence quantities maintained constant.

**Voltage limiting:** the action of limiting the output voltage of a constant-current supply to some predetermined maximum value (fixed or adjustable) and automatically restoring the output current to its normal value when the load conditions are restored to normal. There are two types of voltage limiting: 1) by constant-voltage/constant-current crossover, 2) by decreasing the output current as the voltage increases.

**Warm-up time:** the time interval after switching on a power supply until it complies with all performance specifications.

# POWER SUPPLIES

## System Power Supply Programming Features

477

### Standard Control Features Comparison\*\*

Programmable Feature	HP 6030A to HP 6038A	HP 6621A to HP 6624A and HP 6627A	HP 6632A to HP 6634A	HP 6625A HP 6626A HP 6628A HP 6629A	HP 6651A to HP 6655A
<b>Setting Output</b>					
Set output voltage	X	X	X	X	X
Set output current	X	X	X	X	X
Set output V & C waiting for trigger	X				X
Trigger	X				X
Set output V & C to max					X
Change output V & C by step				X	
Set V & C output range				X	
<b>Protection features</b>					
Set OVP level		X	X	X	X
Overcurrent protection (OCP) enable/disable		X	X	X	X
Output enable/disable	X	X	X	X	X
Reset tripped OVP or OCP	X	X	X	X	X
Protection trip time-delay	X	X	X	X	X
SRQ enable/disable	X	X	X	X	X
Power-on SRQ enable/disable		X	X	X	X
Status mask	X	X	X	X	X
Soft voltage and current limit	X				
<b>Display Control</b>					
Display alphanumeric message		X		X	X
Display on/off		X	X	X	
Select output to be metered				X	
<b>Store/Recall Output State</b>					
Store/Recall output state	X	X		X	X
Define power-on settings		X		X	X
Reset to power-on settings	X	X	X	X	X
<b>Maintenance</b>					
Calibration		X	X	X	X
Self-test	X	X	X	X	X
<b>SCPI/6030 Series Programming Compatibility Mode</b>	X				X
<b>Digital I/O</b>					X
<b>Relay Control</b>	X	*	*	*	X
<b>Extended Addressing</b>					X
<b>Readback information</b>					
<b>Actual Conditions</b>					
Output voltage	X	X	X	X	X
Output current	X	X	X	X	X
Present status	X	X	X	X	X
Latched status	X	X	X	X	X
Programming error codes	X	X	X	X	X
<b>Programmed Values</b>	X	X		X	X

\* Available as an option.

\*\* Commands used for servicing only have not been included.

# POWER SUPPLIES

## Single-Output Linear System Power Supplies

HP 6651A, 6652A, 6653A, 6654A, 6655A

- 500-watt linear output
- Low noise and ripple
- Fast up-and-down programming
- Measured output readback over the HP-IB

- Full front-panel and HP-IB control
- Overvoltage and overcurrent protection
- Standard commands for programmable instruments (SCPI)
- Software calibration

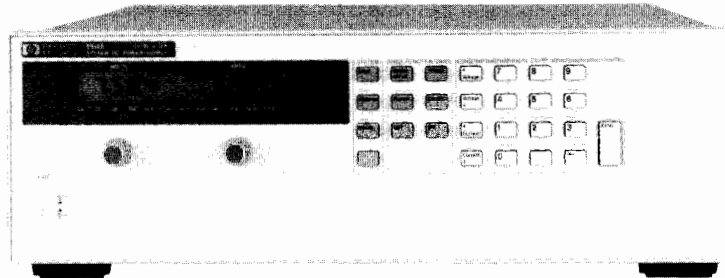

HP 6652A

### HP 6651A-6655A Power Supplies

These single-output, CV/CC, series regulated dc power supplies provide superior performance, and many time-saving system features. As members of Hewlett-Packard's "one-box" solution family of dc power supplies, these models have built-in programming and readback of both the output voltage and current over the HP-IB. This not only means fewer instruments to choose, mount, cable, and maintain, but also results in more complete and accurate system specifications. Most features can be controlled from the front panel as well as over the HP-IB, simplifying system verification.

Up to 16 power supplies can share one HP-IB address, while still providing full independent control, when connected with a modular telephone-style cable. A two-meter cable is included with each unit. Up to a total of 30 meters in length can be used, divided in any way between all of the cables in a power supply chain.

Up to three power supply outputs can be connected in auto-parallel to obtain higher total current. Power supply outputs can be connected in series to obtain higher voltage levels, up to the limit of 240 volts total.

For remote-sensing, up to half the rated output voltage can be dropped in each load lead. This does, however, subtract from the voltage available at the load.

A digital port on the rear panel can provide one of a number of functions, chosen by moving a jumper:

- 3 digital output or 2 digital output and one digital input line
- control of HP relay accessories including DFI/RI (see Accessories)
- DFI/RI (see description under Protection Features)

Fan speed control automatically slows down the cooling fan when loading and ambient temperature permit, allowing for quieter operation.

### Protection Features

The HP 6650 series offers a wide variety of protection features for both the power supply and the load. Overvoltage conditions will trigger the SCR crowbar. Overcurrent conditions can also disable the output. Both of these features can be set and reset over the HP-IB or from the front panel. The power supply also automatically disables its output when an overtemperature situation exists.

An external signal, DFI/RI (discrete fault indicator/remote inhibit), can be used to disable the output independent of the HP-IB. This rear-panel port can also be used to chain multiple power supplies together in such a way that an emergency shutdown of one output will automatically signal the other power supplies to disable their outputs.

These power supplies have full SRQ interrupt capability, with extensive status reporting. This allows the user's program to appropriately react to any of the error or state change conditions.

Local lockout can be used to keep unauthorized operators from changing a power supply setting.

### Programmable Features

The HP 6650 series power supplies are programmed with SCPI (also known as TMSL), the new language standard for programmable test instruments. This standard means that all instruments performing the same function are programmed with the same command, thus increasing programming productivity.

#### HP-IB programmable functions

- Output voltage and current (triggered or immediate)
- Overvoltage and overcurrent protection
- Output enable/disable
- Relay control/digital I/O
- Display on/off
- Alphanumeric message display
- Calibration
- Self-test
- Save instrument state (5 including the power-on state)
- Service request enable
- Status registers
- Maskable trigger
- Group execute trigger

#### HP-IB readback functions

- Measured voltage and current
- Last programmed state of any programmable feature
- Instrument identification
- Status registers
- Digital I/O port status
- Recall instrument state
- Error codes

### Calibration/Maintenance Features

Calibration can be accomplished without removing the covers of the power supply, so the unit need not be removed from the rack. It can be done either from the front panel or over the HP-IB. A user-specified password guards the power supply against unauthorized recalibration.

Self-test is run when the power supply is turned on, or it can be initiated by the computer over the HP-IB.

### Accessories

#### HP 59510-59511A relay accessories

HP 59510A relay accessory can be used to isolate the power supply from the load. HP 59511A relay accessory also performs polarity reversal. See page 488 for more information.

#### HP 14921A calibration software

The HP 14921A power supply calibration software, along with the specified test equipment, can be used to quickly perform calibration and detailed performance tests of any models in the HP 6600 series of power supplies. See page 489 for more details.

**Specifications**

Specifications are warranted over a temperature range of 0-55°C, with the power supply remote sensing at the rear panel power terminals. Derate output current 1% per °C from 40 to 55°C.

Output Ratings				Programming Accuracy 25°C ±5°C		PAR (rms/p-p) 20 Hz-20 MHz		Accuracy of Data Readback 25°C ±5°C			Regulation			
Volts	Amperes at 40°C	Amperes at 55°C	HP Model	Voltage	Current	Voltage	Current	Voltage	+Current	-Current	Load Effect		Source Effect	
											Voltage	Current	Voltage	Current
0-8	50	42.5	HP 6651A	0.06% +5mV	0.15% +60mA	0.3mV/ 3mV	25mA	0.07% +6mV	0.15% +67mA	0.35% +100mA	1mV	2mA	0.5mV	2mA
0-20	25	21.3	HP 6652A	0.06% +10mV	0.15% +25mA	0.3mV/ 3mV	10mA	0.07% +15mV	0.15% +26mA	0.35% +44mA	2mV	1mA	0.5mV	1mA
0-35	15	12.8	HP 6653A	0.06% +15mV	0.15% +13mA	0.4mV/ 4mV	5mA	0.07% +25mV	0.15% +15mA	0.35% +24mA	3mV	0.5mA	1mV	0.75mA
0-60	9	7.7	HP 6654A	0.06% +26mV	0.15% +8mA	0.5mV/ 5mV	3mA	0.07% +40mV	0.15% +7mA	0.35% +15mA	4mV	0.5mA	1mV	0.5mA
0-120	4	3.4	HP 6655A	0.06% +51mV	0.15% +4mA	0.7mV/ 7mV	2mA	0.07% +80mV	0.15% +3mA	0.35% +7mA	5mV	0.5mA	2mV	0.5mA

**Transient response time:** less than 100 μs for the output voltage to recover to its previous level (within 0.1% of the voltage rating of the supply or 20 mV, whichever is greater) following any step change in load current of up to 50% of rated current.

**Isolation:** output terminals can be floated up to ±240 Vdc from chassis ground.

**Input-(ac):** standard ac input voltage is 104-127 Vac, 47-63 Hz. Other voltage inputs are available, see option descriptions. The input can be changed by moving internal jumpers.

**Supplemental Characteristics**

Supplemental characteristics are intended to provide information useful in applying the power supply by describing nonwarranted performance that has been determined by design or type testing.

Model	Average Resolution			Overvoltage Protection Accuracy
	Voltage	Current	OVP	
HP 6651A	2mV	15mA	13mV	160mV
HP 6652A	5mV	7mA	30mV	400mV
HP 6653A	10mV	4mA	54mV	700mV
HP 6654A	15mV	2.5mA	93mV	1.2V
HP 6655A	30mV	1.0mA	190mV	2.4V

Nominal Input Voltage	Input Current
100 Vac	12 A
120 Vac	10 A
220 Vac	5.7A
240 Vac	5.3A

**Maximum input power:** 1380 VA, 1100 W, 120 W at no load.

**Command processing time:** Average time required for the output voltage to begin to change following receipt of command is 20 ms for power supplies connected directly to the HP-IB.

**Output programming response time:** The rise and fall time (10/90% and 90/10%) of the output voltage is less than 15 ms. The output voltage change settles within 1 LSB (0.025% X rated voltage) of the final value in less than 60 ms.

**Monotonicity:** The output is monotonic over the entire rated voltage, current, and operating temperature range.

**Down-programming:** An active down-programmer sinks approximately 20% of the rated output current.

**Maximum reverse current:** With ac power applied, the supply will withstand reverse current equal to the output current rating of the supply continuously, without damage.

**Modulation** (analog programming of output voltage and current):  
 Input signal: 0 to -5 volts  
 Input impedance: 10 kΩ nominal

**RFI suppression:** Designed to comply with VDE 0871/6.78 level B.

**Safety agency compliance:** designed to comply with IEC 348, VDE 0411, UL 1244, and CSA 556B.

**Calibration interval:** One year.

**Size** (all models): 132.6H x 425.5W x 497.8mmD. (5.22" x 16.75" x 19.6")

**Weight** (all models): net, 25 kg (54 lb); shipping 28 kg (61 lb)

**HP-IB interface capabilities:** IEEE 488.2 SH1, AH1, T6, L4, SR1, RL1, PP0, DC1, DT1, E1, and C0.

**Warranty Period:** Three years.

**Ordering Information**

HP 6651A	8 volts, 50 amperes	\$2,800
HP 6652A	20 volts, 25 amperes	\$2,600
HP 6653A	35 volts, 15 amperes	\$2,600
HP 6654A	60 volts, 9 amperes	\$2,600
HP 6655A	120 volts, 4 amperes	\$2,650

**Option descriptions**

Opt 100:	87-106 Vac, 47-63 Hz. (for Japan only)	\$0
Opt 220:	191-233 Vac, 47-63 Hz.	\$0
Opt 240:	209-250 Vac, 47-63 Hz.	\$0
Opt 908:	Rackmount kit (HP p/n 5062-3977)	+\$35
Opt 909:	Rackmount kit with handles (HP p/n 5062-3983)	+\$85
Opt 910:	Service manual and extra operating manual. Standard unit is shipped with operating manual only.	+\$30

# POWER SUPPLIES

## Single Output Linear System Power Supplies

HP 6632A, 6633A and 6634A

- 100 watt linear output
- Current-sinking capability
- Built-in HP-IB Interface
- Overvoltage & overcurrent protection
- Readback measured voltage and current Output via HP-IB

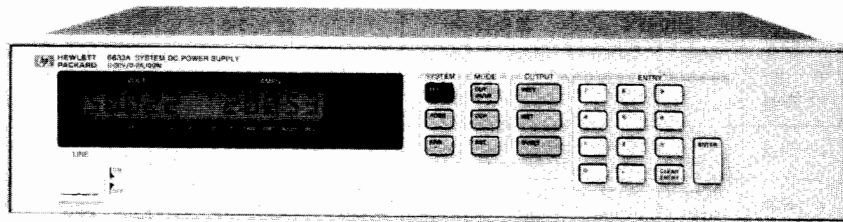

HP 6633A



### HP 6632A-6634A Power Supplies

HP Models 6632A-6634A are 100 Watt, single output, series pass regulated power supplies optimized for systems applications. They provide a high performance output with a full set of programmable features.

The following voltage and current combinations are available:

HP 6632A: 0-20 V	0-±5 A
HP 6633A: 0-50 V	0-±2 A
HP 6634A: 0-100 V	0-±1 A

Most importantly, these models are one-box solutions for system power supply requirements. Both the voltage and current output can be programmed for either CV or CC operation. A built-in DVM and precision current shunt measure (readback) the actual power supply output. The internal HP-IB interface allows for complete programmability, including status reporting and interrupt generation with user designated fault conditions. In addition, programming commands (such as VSET for voltage programming) are easy-to-use and self-documenting.

#### Current Sinking

HP Models 6632A-6634A sink as well as source current. This provides very fast down programming times and speeds throughput in production test applications. The negative current setting tracks the user-programmed positive current (CC) setting.

#### Remote Sensing

Remote sense terminals allow for precise voltage regulation at the load. This feature will compensate for load lead IR drops of up to 2 volts per lead.

#### Protection Features

HP Models 6632A-6634A have Overvoltage and Overcurrent protection. Both features are programmable via the front panel keypad and HP-IB. The Overvoltage protection includes an SCR crowbar.

#### Selftest

HP Models 6632A-6634A have a built-in selftest capability. This feature verifies the function of all HP-IB circuitry, D/A's, and A/D's at power on and upon HP-IB command.

#### Software Calibration

Software calibration eliminates shock sensitive potentiometers normally used for calibration of power supplies and programmers. This

feature enables calibration of these models via the HP-IB while mounted in the rack. An internal jumper is provided which, when removed, prevents recalibration of the power supply.

#### Fast/Normal Mode Operation

A rear-panel switch designates one of two operating modes. In Fast Mode, the output capacitors are disconnected to speed up the output response time. Normal Mode is optimized for minimal output PARD. See specifications for more information.

#### Front Panel Binding Posts (Option 020)

Option 020 adds a front panel output in parallel with the rear panel output terminal strip. These front panel binding posts provide flexibility in accessing the power supply output, and are very useful in bench applications and system development.

#### Isolation, Polarity Reversal Relay and DFI/RI (Option 760)

Optional built-in relays provide output connect/disconnect and polarity reversal. Discrete Fault Indicator and Remote Inhibit lines are included along with a quick disconnect DC output terminal connector. See page 488 for more detail.

#### HP-IB Functions

The following functions can be programmed via the HP-IB:

Programmable Functions	Readback Functions
— Voltage Output	— Actual Measured Voltage Output
— Current Output	— Actual Measured Current Output
— Overvoltage Protection	— Present Status
— Overcurrent Protection	— Accumulated Status
— Output Enable/Disable	— Programming Error Codes
— Fault Interrupt	— Fault Codes
— Software Calibration	— Service Request
— Selftest	

#### Specifications (Data Subject to Change)

**HP-IB Interface Functions:** The following HP-IB functions are implemented:

SH1, AH1 T6, L4, SR1, RL1, PP1, DC1, DT0 and E1.

**Safety Agency Compliance:** HP Models 6632A-6634A power supplies are designed to comply with the following regulatory standards:

IEC 348, VDE 0411, UL 1244 and CSA Electrical Bulletin 556B.

**Weight kg (lb) (all models):** Net 10.5 (23), Shipping 12.3 (27)

**Input Current:** 100 VAC 120 VAC 220 VAC 240 VAC  
(Max. rms all models) 3.3 A 2.9 A 1.7 A 1.6 A

**Input requirements:** 350 VA max.  
250 watts max.

**Warranty period:** Three years.



**Specifications (Data Subject to Change)**

Note: Specifications are worst case unless otherwise noted.

	Volts	0-20 V	0-50 V	0-100 V	
	Amps	0-5 A	0-2 A	0-1 A	
	Watts	100 W	100 W	100 W	
<b>Hewlett-Packard Model</b> Specified over an operating temperature range of 0-55°C.		HP 6632A	HP 6633A	HP 6634A	
<b>Load Effect (Load Regulation):</b> For a load change from zero to maximum rated voltage or current of the supply.**	Voltage	2 mV	4 mV	5 mV	
	Current	1 mA	1 mA	1 mA	
<b>Source Effect (Line Regulation):</b> Given for any change within the rated line voltage for any output within the rated output voltage, current, and power of the supply.	Voltage	0.5 mV	1 mV	1 mV	
	Current	0.5 mA	0.25 mA	0.25 mA	
<b>Ripple and Noise (PARD):</b> rms/peak-peak (20 Hz - 20 MHz).	Voltage(Normal)	0.3 mV/3 mV	0.5 mV/3 mV	0.5 mV/3 mV	
	Voltage(Fast)	1 mV/10 mV	1 mV/15 mV	2 mV/25 mV	
	Current(rms)	2 mA	2 mA	2 mA	
<b>Drift (Stability):</b> Change in output over 8-hour interval under constant line, load, and ambient temperature following 30-minute warm-up.	Voltage	0.01%+0.5 mV	0.01%+1 mV	0.01%+1 mV	
	Current	0.01%+1 mA	0.01%+0.5 mA	0.01%+0.3 mA	
<b>Load Effect Transient Recovery:</b> Maximum time required for output voltage to recover within a band of 0.1% of rated voltage around the nominal voltage following a 50% change in load current.	Normal	100 μs	100 μs	100 μs	
	Fast	50 μs	50 μs	50 μs	
<b>Programming:</b> (25±5°C) Given for control of the output over the HP-IB or with front panel controls.	Voltage	Resolution	5 mV	12.5 mV	25 mV
		Accuracy	0.05%+10 mV	0.06%+20 mV	0.05%+50 mV
	+Current	Resolution	1.25 mA	0.5 mA	0.25 mA
		Accuracy	0.15%+7 mA	0.15%+2 mA	0.15%+1 mA
Minimum CC programming current.		20 mA	8 mA	4 mA	
<b>Temperature Coefficient:</b> Output change per degree Celsius change in ambient following 30-minute warm-up.	Voltage	70ppm+0.25 mV	70ppm+0.5 mV	70ppm+1 mV	
	+Current	150ppm+500 μA	150ppm+150 μA	150ppm+75μA	
<b>Output Response:</b> Maximum time for output voltage to change within ±0.025% of final value (LSB), and from 10% to 90%, or 90% to 10% of voltage excursion (Tr/Tf).	Normal	Tr/Tf	15 ms	15 ms	15 ms
		LSB	60 ms	60 ms	60 ms
	Fast	Tr/Tf	400 μs	400 μs	400 μs
		LSB	2 ms	2 ms	2 ms
<b>HP-IB Programming Command Processing Time:</b> (Display disabled)	Typical	10 ms	10 ms	10 ms	
<b>Voltmeter:</b> (25±5°C) Refers to data read back to the controller from the HP-IB and as viewed via the front panel display.	Resolution	5 mV	12.5 mV	25 mV	
	Accuracy	0.07%+15 mV	0.07%+30 mV	0.06%+70 mV	
<b>Ammeter:</b> (25±5°C) Refers to data read back to the controller from the HP-IB and as viewed via the front panel display.	Resolution	1.25 mA	0.5 mA	0.25 mA	
	Accuracy	0.18%+9 mA	0.17%+3 mA	0.15%+2 mA	
<b>DC Output Isolation:</b> Maximum voltage either output terminal (±) may be from chassis ground.		±240 Vdc	±240 Vdc	±240 Vdc	
<b>Remote Sensing:</b> Maximum allowable voltage drop per load lead.		2 Vdc	2 Vdc	2 Vdc	

\*\*Specification under Local Sensing.

**Ordering Information**

HP 6632A: 20 volts, 5 amperes power supply

HP 6633A: 50 volts, 2 amperes power supply

HP 6634A: 100 volts, 1 amperes power supply

Standard Input: 104-127 Vac, 48-63 Hz

Opt 100 87-106 Vac, 48-63 Hz, (for Japan only) \$0

Opt 220 191-233 Vac, 48-63 Hz. \$0

Opt 240 209-250 Vac, 48-63 Hz. \$0

Opt 020 Front output binding posts + \$79

Opt 760 Isolation and polarity reversal relay + \$405

Opt 908 Rackmount kit for one unit. (HP P/N 5061-9674) + \$32

Opt 909 Rackmount kit with handles (HP P/N 5061-9675) + \$75

Accessory: Rack Slide Kit (HP P/N 1494-0059) \$100

Opt 910 One each extra operating and service manuals. (Operating manual only is shipped with standard unit.) + \$32

**Price\***

\$1700

\$1700

\$1700

**Dimensions**

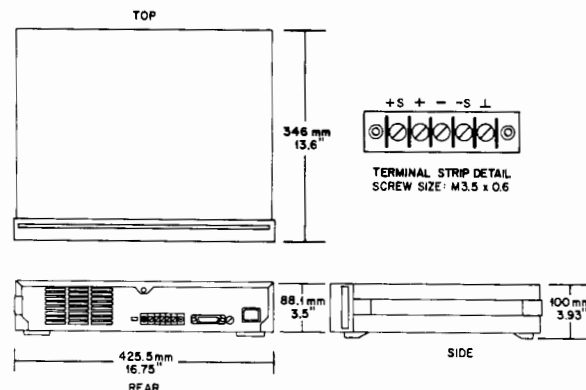

☎ For same-day shipment, call HP DIRECT at 800-538-8787

# POWER SUPPLIES

## Multiple Output Linear System Power Supplies

HP 6621A, 6622A, 6623A, 6624A and 6627A

- 2, 3 or 4 Independent Isolated Outputs per Model
- 160 Watts Total Output Power per Model
- HP-IB Programming of Voltage and Current
- HP-IB Measurement of Voltage and Current
- Full Local Control or Local Lockout
- Programmable Overvoltage and Overcurrent Protection

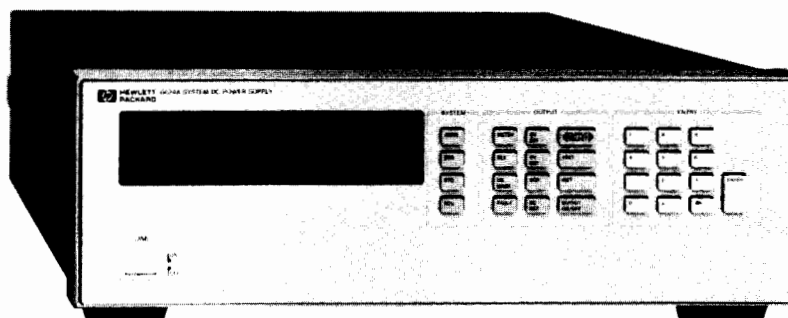

HP 6624A

### Description

These HP-IB multiple output series regulated system power supplies feature a combination of intelligence, performance and low price which makes them the choice for power systems applications.

Five models, each offering a total of 160 watts output power, offer a variety of output combinations of 40 and 80 watts with voltages up to 50 volts and currents to 10 amps. Each output can produce power in two ranges (see fig. 1). For example, model 6622A has two 80 watt outputs. Each of these can produce 80 watts at either 20 volts or 50 volts. When operating below 20 volts, each output can source or sink up to 4 amps. When operating between 20 volts and 50 volts, it can source or sink up to 2 amps. Output combinations include:

- 6621A - 2 outputs at 80 watts, either 0-7 or 0-20 volts
- 6622A - 2 outputs at 80 watts, either 0-20 or 0-50 volts
- 6623A - 1 output at 80 watts, 0-7 or 0-20 volts; 1 at 40 watts, 0-20 or 0-50 volts; 1 at 40 watts, 0-7 or 0-20 volts
- 6624A - 4 outputs at 40 watts: two at 0-7 or 0-20 volts and two at 0-20 or 0-50 volts
- 6627A - 4 outputs at 40 watts, either 0-20 or 0-50 volts

The built-in interface is tailored to the power supply, resulting in simpler programming. Specifications supplied with these power supplies already take both the power supply and programming interface into account as a system. Self-contained measurement and readback capabilities eliminate the need for scanning the output or using a separate DVM.

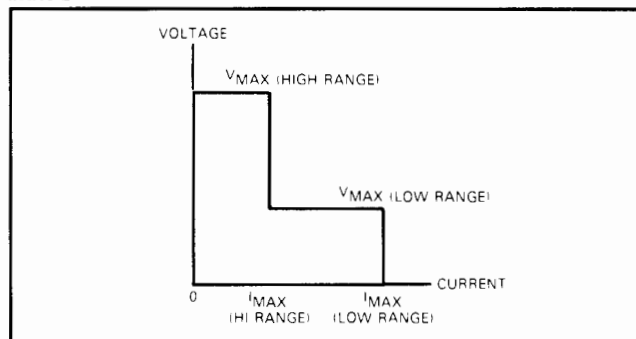

Fig 1. Output Characteristic Curve for HP 662X Series Power Supplies

### Programming Capabilities

These power supplies share the programming command set of HP Models 6632A-6634A and 6030A-6038A programmable power supplies. (see page 477) The following functions are implemented:

- Output Voltage and Current Programming
- Output Voltage and Current Measurement and Readback
- Present and Accumulated Status Readback
- Programmable Service Request Mask
- Programmable Overcurrent Protection
- Programmable Overvoltage Protection
- Storage and Recall of Programmed Value Sets (all outputs)
- Echo Queries of Programmable Functions/Settings
- Output Channel Enable/Disable
- Programming Syntax Error Detection
- Reprogramming Delay Time for Service Request Mask

Operating voltage and current range is selected programmatically, with the last parameter programmed (voltage or current) determining the range. No separate command is required to switch output range.

Programmed command processing time is typically 7 milliseconds. Response time to within settling band is additional.

### Protection Features

Local lockout capability enables the programmer to disable all front panel controls over the HP-IB except the channel select (to allow display of the output voltage and current of any channel.)

Protection against overcurrent conditions is provided by either the current limit or overcurrent protection. Current limit will prevent the output current from exceeding a programmed value, while overcurrent protection will disable the supply if that value of current is reached. Current limit is always active, while overcurrent protection can be enabled or disabled.

As an example of its use, consider testing PC board subassemblies with a programmable power supply. A shorted component would cause current to be drawn from the power supply at the current limit value, possibly burning the board. Enabling overcurrent protection would cause the power supply to disable itself when the current limit value is reached, thus minimizing damage.

Protection against output overvoltage conditions is also provided. Normally, the power supply voltage will not exceed the programmed voltage setting. Programmable overvoltage protection guards your load against hardware faults by disabling and down-programming the power supply output if the programmed overvoltage setting is exceeded. A crowbar circuit is activated and shorts the output under these conditions.

This series also provides protection from unregulated output in the event of line voltage dropout and also guards against overtemperature conditions. The output is disabled when either of these conditions exists.

A service request can be generated to inform the controller in the event of any user-defined combination of overvoltage, overcurrent, overtemperature or mode change.

Fault trips which disable the output can be reset over the HP-IB.

### Output Ratings And Combinations

OUTPUT	CHANNEL	NUMBER OF OUTPUTS PER MODEL				
		HP 6627A (4 output)	HP 6624A (4 output)	HP 6623A (3 output)	HP 6622A (2 output)	HP 6621A (2 output)
0-20/ 0-2	0-7/ 0-5	-	2	1	-	-
0-50/ 0-0.8	0-20/ 0-2	4	2	1	-	-
0-20/ 0-4	0-7/ 0-10	-	-	1	-	2
0-50/ 0-2	0-20/ 0-4	-	-	-	2	-

**Software Calibration And Selftest**

With this series of power supplies, calibration is performed without removing the instrument's cover. All that is required is a shunt, a dvm, a controller and a few lines of code. Simple commands instruct the power supply to go to preset adjustment points, where voltages or currents are read with the dvm and shunt. Then the readings are sent to the power supply, which adjusts its calibration. Calibration is maintained through line voltage cycling.

Calibration integrity can be assured by using a jumper inside the box which, when removed, will prevent the supply from accepting calibration commands.

These supplies also have considerable selftest capability, which is exercised at power on and upon receipt of the selftest command over the HP-IB. Running selftests over the HP-IB will not cause the output to change.

**System Configuration**

This series of power supplies offers a number of significant benefits in the area of simplicity and flexibility of system configuration.

A convenient rear panel line voltage module allows switching of input line voltage without removing the covers. (The line voltage option determines line cord plug configuration.)

For applications which require different combinations of voltage and current for different loads, the dual range full power feature will be useful (see fig. 1). If this is not enough, two outputs can be combined in parallel or series combinations for more power at a given voltage or current level.

Where a precisely regulated voltage is required at the load, remote sensing at the load can be used. This capability will compensate for load lead IR drops of up to 1 volt per load lead. Add 1mV to the load effect specification for each 200 mV drop in the negative load lead when remote sensing.

All outputs of these power supplies are isolated for up to 240 volts dc from chassis ground and each other.

For applications which require a hardware trip signal separate from the HP-IB remote disable, terminals are provided on the rear panel barrier block of each output which provide bidirectional overvoltage protection trip capability. These terminals can be used to monitor for an OVP trip signal, strapped together to disable all outputs when one OVP is tripped or used as a remote disable separate from the HP-IB.

These models can sink as well as source current. This means that downprogramming without a load takes the same time as upprogramming. Quick discharging of reactive loads is another benefit resulting from this capability.

**Front Panel Control**

To aid in system program development, the following capabilities of these power supplies are controllable from the front panel:

- Output Channel Select (Controls and Display)
- OVP Setting
- Overcurrent Protection Enable
- Storage and Recall of Programmed Settings
- Voltage Setting
- Current Setting
- SRQ Mask Delay Time
- Output Enable/Disable
- OVP, OCP Reset
- Local

The alphanumeric LCD display will normally display output voltage and current for the channel selected. When programming from the front panel, the function being programmed and the present value

will be displayed. Fault conditions will be spelled out in alpha characters. Output channel is indicated by an annunciator.

Changing the HP-IB address is done from the front panel, using the address key and the numeric keypad.

**CIIL Programming (Option 700)**

Enables programming in CIIL, Control Intermediate Interface Language. Includes Option 750.

**Relay Controls, Fault Indicator, and Remote Inhibit Option 750**

Option 750 for the HP 662XA series includes protection features and relay controls. The protection features include the discrete fault indicator line (FLT) and the remote inhibit line (INH). The fault line is a two pin TTL output port which goes true whenever a user-specified error condition exists. The remote inhibit line is a two pin TTL input port which can be used to disable the power supply output. These lines provide protection independent of the HP-IB. The relay controls (RLY), together with external user-supplied relay such as the HP 59510A or HP 59511A, physically disconnect the power supply outputs from the load (or system). Each of the four open collector RLY controls can sink 120 mA. They can be programmed over HP-IB with the RELAY and OUT commands or operated with the front panel OUTPUT ON/OFF function key. See page 488 for further information.

**General Specifications**

**HP-IB interface functions:** SH1, AH1, T6, L4, SR1, RL1, PP1, DC1, DT0.

**Safety agency compliance:** This series of power supplies is designed to comply with the following regulatory standards: IEC 348, VDE 0411, UL 1244, ANSI C39.5, and CSA Electrical Bulletin 556B.

**Dimensions (all models):** 132.6H x 425.5W x 497.8 mm D. (5.22" x 16.75" x 19.6")

**Input current:** 100 Vac 120 Vac 220 Vac 240 Vac  
(max.rms, all models) 6.3 A 5.4 A 3.0 A 3.0 A

**Standard input:** 104-127 Vac, 47-66 Hz

**Weights kg(lb) (all models):** Net 17.4(38) Shipping 22.7(50)

**Warranty Period:** Three years.

**Prices And Option Descriptions**

- HP 6621A Dual output system power supply. \$3,850
- HP 6622A Dual output system power supply. \$3,850
- HP 6623A Triple output system power supply. \$4,350
- HP 6624A Quad output system power supply. \$4,850
- HP 6627A Quad output system power supply. \$4,850
- Opt 100 87- 106 Vac, 47-66 Hz. (for Japan only) \$0
- Opt 220 191-233 Vac, 47-66 Hz. \$0
- Opt 240 209-250 Vac, 47-66 Hz. \$0
- Opt 700 CIIL programming for MATE in place of HP-IB + \$525
- Opt 750 Protection feature and relay controls + \$265
- Opt 908 Rackmount kit for one unit (no handles) + \$35
- Opt 909 Rack kit with handles + \$85
- Opt 910 One each extra operating and service manuals. (Operating manual only is shipped with standard unit.) + \$32

**Output Channel Specifications (READ ACROSS FROM PREVIOUS PAGE) (at 0° to 55° C unless otherwise specified)**

HP-IB OUTPUT SETTINGS				HP-IB MEASUREMENT READBACK ACCURACY **		PARD (p-p/rms)		REGULATION				PROGRAMMING SPEED		
RESOLUTION		ACCURACY**						LOAD EFFECT		SOURCE EFFECT		TIME	RESPONSE	SETTLING
VOLTAGE	CURRENT	VOLTAGE	CURRENT	VOLTAGE	CURRENT	VOLTAGE	CURRENT	VOLTAGE	CURRENT	VOLTAGE	CURRENT	CONSTANT	TIME	BAND
6 mV	25 mA	19 mV + 0.06%*	50 mA + 0.16%*	20 mV + 0.05%*	10 mA + 0.1%*	3 mV/500 µV	1 mA rms	2 mV	1 mA	1 mV + 0.01%*	1 mA + 0.06%*	250 µs	2 ms	20 mV
15 mV	10 mA	50 mV + 0.06%*	20 mA + 0.16%*	50 mV + 0.05%*	4 mA + 0.1%*	3 mV/500 µV	1 mA rms	2 mV	0.5 mA	1 mV + 0.01%*	1 mA + 0.06%*	750 µs	6 ms	50 mV
6 mV	50 mA	19 mV + 0.06%*	100 mA + 0.16%*	20 mV + 0.05%*	20 mA + 0.1%*	3 mV/500 µV	1 mA rms	2 mV	2 mA	1 mV + 0.01%*	2 mA + 0.06%*	250 µs	2 ms	20 mV
15 mV	20 mA	50 mV + 0.06%*	40 mA + 0.16%*	50 mV + 0.05%*	8 mA + 0.1%*	3 mV/500 µV	1 mA rms	2 mV	1 mA	1 mV + 0.01%*	2 mA + 0.06%*	750 µs	6 ms	50 mV

\*% of setting. \*\* For a ±5°C range about the calibration temperature

# POWER SUPPLIES

## Precision Multiple Output System Power Supplies

HP 6625A, 6626A, 6628A and 6629A

- 2 or 4 independent isolated outputs per model
- 14-bit programming of voltage and current
- Two ranges cover: 0.5 mv to 50 volts; 1  $\mu$ A to 2 As

- HP-IB control and measurement of voltage and current
- Current sinking capability for fast response
- Extensive protection for DUT and power supply



HP 6626A

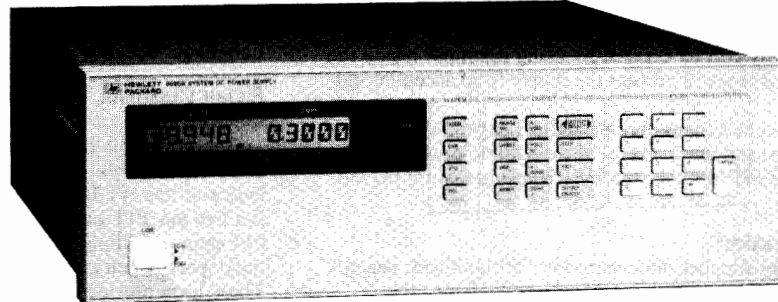

### Description

These HP-IB precision multiple output series regulated system power supplies provide a combination of features and performance that make them an excellent choice for automated component testing and other system applications requiring precision control.

These models are one-box solutions for those applications that require both sourcing and measurement of the load voltage and current. The built-in DVM and precision current shunt allow readback of actual power supply output variables over the HP-IB.

The models provide different combinations of two output types: the 25 watt output offers 50 volts at 0.5 amps with a rectangular output characteristic; the 50 watt output offers 50 volts or 2 amps, with an L-shaped output characteristic (see fig. 1.). The HP 6625A is a dual output supply offering one of each output type for a total of 75 watts. The HP 6626A is a quad output supply offering two of each output type for a total of 150 watts. The HP 6628A is a dual output supply and the HP 6629A is a quad output supply, both of which offer all 50 watt outputs.

Each output offers a high and low range of operation for both voltage and current. The ranges can be selected independently; the resulting output combinations are shown in the table on the facing page.

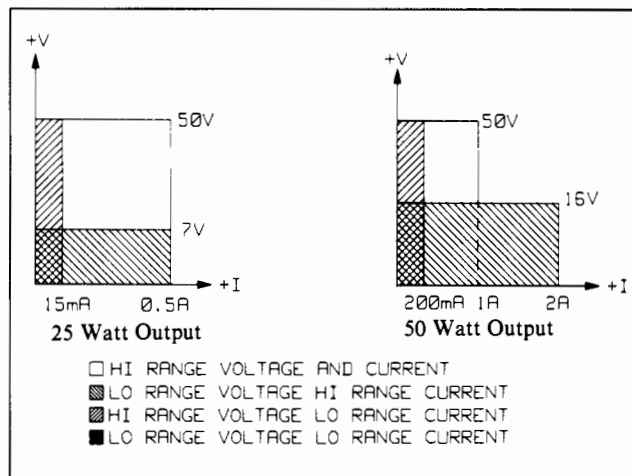

Figure 1: Output characteristics for HP 6625A, 6626A, 6628A, and 6629A.

### Current Sinking

Each output has the capability to sink well as source current, so that voltage down-programming can be accomplished as quickly as up-programming, even without a load.

### Remote Sensing

Remote sense terminals allow for precise voltage regulation at the load. These power supplies can accommodate up to 10 volts of sense lead drop (within a maximum of 50 volts at the output terminals of the power supply).

### Output Configuration Flexibility

Outputs of the same type can be operated in series or parallel combinations for increased output voltage or current capability. All outputs of these supplies are isolated for up to 240 volts dc from chassis ground and from each other.

Bi-polar operation can be achieved by connecting two outputs of the same type in a series opposing mode.

### Programming Capabilities

The internal HP-IB interface allows complete programmability, including status reporting and interrupt generation with user designated fault conditions. Programming commands (such as VSET for voltage programming) are easy to use and self documenting. These power supplies share the programming command set of HP Models 6621A-6624A, 6632A-6634A, and 6030A-6038A programmable supplies as described on page 477. The following functions are implemented:

- Output Voltage and Current Programming
- Voltage and Current Range Programming
- Output Voltage and Current Measurement and Readback
- Present and Accumulated Status Readback
- Programmable Service Request Mask
- Programmable Overvoltage and Overcurrent Protection
- Storage and Recall of Programmed Voltage and Current Values for all outputs
- Echo Queries of Programmable Functions and Settings
- Output Enable or Disable
- Programming Syntax Error Detection
- Programmable Delay Time for Service Request and Over Current Protection Mask
- Software Calibration of Voltage, Current, and Overvoltage
- HP-IB Interface Selftest
- Message Display Capability on the Front Panel
- Programmed command processing time is typically 7 milliseconds. Response time to within settling band is additional (see Output Response specification on the facing page).

### Front Panel Control

To aid in system program development, a wide range of control capabilities are provided from the front panel.

- \* Output Channel Select (Controls and Display)
- \* OVP Setting
- \* Overcurrent Protection Enable
- \* Storage and Recall of Programmed Settings
- \* Setting the HP-IB Address
- \* Voltage and Current Setting
- \* Output Range Setting
- \* Output Enable/Disable
- \* OVP, OCP Reset
- \* Local / HP-IB Operation

The alphanumeric LCD display will normally display output voltage and current for the channel selected. When programming from the front panel, the function being programmed will be displayed. Fault conditions will be spelled out in alpha characters. Output channel is indicated by annunciators.

## Protection Features

Local lockout capability enables the programmer to disable all front panel controls over the HP-IB except the channel select (for monitoring purposes).

All outputs have both Overvoltage and Overcurrent protection. The Overcurrent protection will disable the supply if the programmed current limit is reached. Programmable Overvoltage protection guards your load against hardware faults by disabling and down-programming the power supply if the programmed overvoltage setting is exceeded. A crowbar circuit is activated and shorts the output under these conditions.

This series also provides protection from unregulated output in the event of line voltage dropout, and guards against overtemperature. The output is disabled when either of these conditions exists.

A service request can be generated to inform the controller in the event of any user-defined combination of overvoltage, overcurrent, overtemperature or mode change. Fault trips which disable the output can be reset over the HP-IB.

For applications which require a hardware trip signal separate from the HP-IB remote disable, terminals are provided on the rear panel barrier block of each output which have bi-directional trip capability. These terminals can be used to monitor for an OVP trip signal, can be strapped together to disable all outputs when one OVP is tripped, or can be used as a remote disable, separate from the HP-IB.

## Relay Controls, Discrete Fault Indicator, and Remote Inhibit

Option 750 includes additional protection features and relay controls. Included is a discrete fault indicator line (FLT) and the remote inhibit line (INH). The fault line is a two pin TTL output port which goes true whenever a user-specified error condition exists. The remote inhibit line is a two pin TTL input port which can be used to disable the power supply output. These lines provide protection independent of the HP-IB. The relay controls (RLY), together with external user supplied relays or accessory relays such as the HP 59510A or HP 59511A, physically disconnect the power supply outputs from the load (or system). Each of the four open collector RLY controls can sink 120 ma. They can be programmed over HP-IB with the RELAY and OUT commands or operated with the front panel OUTPUT ON/OFF function key. See page 488 for a complete description of the Models 59510A and 59511A Relay Boxes.

## Software Calibration and Selftest

Just as on the HP 662XA and 663XA series, calibration can be performed without removing the instrument's cover. All that is required is a shunt, a DVM, a controller and a few lines of code. Simple commands instruct the power supply to go to preset adjustment points, where voltages or currents are read with the DVM and shunt. Then the readings are sent to the power supply which adjusts its calibration.

Calibration is maintained through input line voltage cycling. An internal jumper can be removed to prevent the supply from accepting unintentional calibration commands.

The selftest is exercised at power on and upon receipt of the selftest command over the HP-IB. Running selftests over the HP-IB will not cause the output to change.

## General Specifications

### Output Ratings and Combinations

Output Channel	Number of Outputs per HP Model			
	6625A	6626A	6628A	6629A
25 watt	1	2	0	0
50 watt	1	2	2	4

For additional output channel specifications, see table below.

**Output Response:** (all outputs)

**Max Output Programming Time:** 6 ms

**Max Time Constant:** 750  $\mu$ s

**Settling Band:** Within 50 mV of programmed value

**Command Processing Time:** Typically 7 ms (with front panel display disabled)

**Load Transient Recovery:** (all outputs) Time to recover within 75 mV of nominal value: 75  $\mu$ s

**Current Sink Capability:** (for any voltage above 4 volts)

**50 watt outputs:** 1 amp (2 amp below 16 volts)

**25 watt outputs:** 0.5 amps

**HP-IB interface functions:** SH1, AH1, T6, L4, SR1, RL1, PP1, DC1, DT0, C0, E1. For more information on these codes, refer to the HP-IB section of this catalog.

**Safety agency compliance:** This series of power supplies is designed to comply with the following regulatory standards: IEC 348, VDE 0411, UL 1244, ANSI C39.5, and CSA Electrical Bulletin 556B.

**Size (all models):** 132.6 mm H x 422.5 mm W x 497.8 mm D.  
(5.22" x 16.75" x 19.6")

**Input current:** 100 VAC 120 VAC 220 VAC 240 VAC  
(max. rms, all models) 6.3 A 5.4 A 3.0 A 3.0 A

**Standard input:** 104-127 Vac, 47-66 Hz

**Weight kg (lb) (all models):** Net 17.4 (38) Shipping 22.7(50)

**Warranty Period:** Three Years

## Accessory

**HP Model 14852A Bias Cable:** can be used with either quad output supply (HP 6626A or 6629A) to simplify the design of a three-terminal device test set-up. It leads the four outputs and sense lines to two bnc-style connectors, as described in Application Note 376-1.

## Ordering Information

	Price
HP 6625A Dual output system power supply	\$4675
HP 6626A Quad output system power supply	\$7800
HP 6628A Dual output system power supply.	\$4675
HP 6629A Quad output system power supply.	\$7800
Opt 100 87- 106 VAC, 47-66 Hz. (for Japan only)	\$0
Opt 220 191-233 VAC, 47-66 Hz.	\$0
Opt 240 209-250 VAC, 47-66 Hz.	\$0
Opt 750 Relay Control and DFI/RI	+ \$265
Opt 908 Rackmount Kit for one unit (no handles)	+ \$35
Opt 909 Rack Kit with handles	+ \$85
Opt 910 One each extra operating and service manuals (Operating manual only is shipped with standard unit.)	+ \$32
HP 14852A bias cable	\$300

## Output Channel Specifications (at 0°C to 50°C unless otherwise specified)

TYPE	OPERATING RANGE	OUTPUT			READBACK		PARD rms/p-p	REGULATION	
		SETTING	RESOLUTION	ACCURACY*	RESOLUTION	ACCURACY*		LOAD EFFECT	SOURCE EFFECT
25 watt	Lo Range/Voltage	0-7 volts	0.5 mV	1.5 mV +0.016%	0.5 mV	2 mV +0.016%	0.5 mV/3 mV	0.5 mV	0.5 mV
	Lo Range/Current	0-15 mA	1 $\mu$ A	15 $\mu$ A +0.04%	1 $\mu$ A	15 $\mu$ A +0.03%	0.1 mA/-	5 $\mu$ A	5 $\mu$ A
	Hi Range/Voltage	0-50 volts	4 mV	10 mV +0.016%	4 mV	10 mV +0.016%	0.5 mV/3 mV	0.5 mV	0.5 mV
	Hi Range/Current	0-0.5 A	40 $\mu$ A	100 $\mu$ A +0.04%	50 $\mu$ A	130 $\mu$ A +0.03%	0.1 mA/-	5 $\mu$ A	5 $\mu$ A
50 watt	Lo Range/Voltage	0-16 volts	1 mV	3 mV +0.016%	1 mV	3.5 mV +0.016%	0.5 mV/3 mV	0.5 mV	0.5 mV
	Lo Range/Current	0-0.2 A	15 $\mu$ A	185 $\mu$ A +0.04%	15 $\mu$ A	250 $\mu$ A +0.04%	0.1 mA/-	10 $\mu$ A	10 $\mu$ A
	Hi Range/Voltage	0-50 volts	4 mV	10 mV +0.016%	4 mV	10 mV +0.016%	0.5 mV/3 mV	0.5 mV	0.5 mV
	Hi Range/Current	0-2 A	160 $\mu$ A	500 $\mu$ A +0.04%	160 $\mu$ A	550 $\mu$ A +0.04%	0.1 mA/-	10 $\mu$ A	10 $\mu$ A

\* For a  $\pm 5^\circ$ C range about the calibration temperature

# POWER SUPPLIES

## Autoranging System Power Supplies

HP 6030A, 6031A, 6032A, 6033A, 6035A and 6038A

- HP-IB programming of voltage and current
- Readback of voltage, current and status
- Overvoltage and overcurrent protection

- Built-in self-test and diagnostics
- Up to 1200 watts output
- Full local control enable/disable



HP 6033A, 6038A

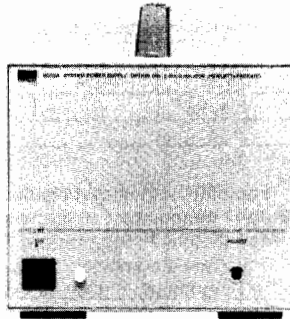

HP 6033A and 6038A  
with Opt 001

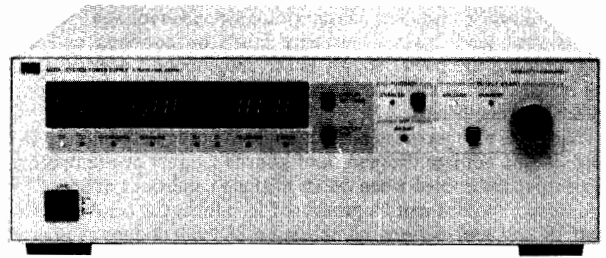

HP 6030A, 6031A, 6032A and 6035A



### Description

These HP-IB CV/CC dc power supplies have many productivity-oriented features which make them easy to program, integrate into systems and use.

A conventional power supply subsystem capable of monitoring and controlling power supply voltage and current requires a variety of hardware in addition to the actual supply. These new power supplies, however, have built-in capabilities which eliminate the need for D/A programmers, DVMs, and associated auxiliary circuitry. Fewer instruments mean less rack space, easier calculation of system specifications, quicker configurations, higher system reliability, more rapid troubleshooting, and simpler software. As autoranging power supplies, these models can provide a wide and continuous range of voltage and current combinations at the maximum rated power. This often allows both present and future requirements to be satisfied with fewer supplies, also reducing the number of instruments in the system.

### Front Panel Control

Most of the extensive programmable instruction set can be simulated with front panel controls, thus facilitating design and debugging of system hardware and software. During system operation, if local control is not needed, the front panel controls can be disabled with a computer command. If operator interaction is required, a computer command can place limits on the output voltage and current available. Often, control and monitoring via the front panel is very useful during system development, but not needed afterwards. If the system is reproduced without further development, power supplies without front panel controls and meters (Option 001) can then be used (except HP 6035A). Ordering your power supplies with Option 001 significantly decreases the cost.

### Protection Features

Because of the delicate nature of most loads, these system power supplies provide several different types of protection. Since they are CV/CC supplies, both the output voltage and current will be automatically limited to the programmed values. If reaching a programmed value indicates an undesirable condition, the power supply can be instructed to automatically down-program to zero output. For example, if the programmed current limit is reached while testing a PC board assembly, it may indicate a shorted component. In this case, the FOLDBACK feature, if enabled, would be able to serve as an overcurrent protection circuit and down-program the power supply automatically. FOLDBACK can be enabled and reset over the HP-IB.

The built-in overvoltage protection circuit is adjustable with a front panel control. The set trip level can be displayed on the front panel meter and also can be read back over the HP-IB, thus making adjusting the level easy. The OVP circuit, once tripped, can be reset over the HP-IB.

Production procedures sometimes require the operator to adjust the output voltage or current of a power supply locally with the front panel controls. If this is done, programmed levels can be set to limit the available adjustment range to a safe margin.

Potentially harmful conditions, such as overtemperature and high or low ac input, will trigger the power supply to automatically down-program to zero output. When these conditions occur, or the FOLDBACK or OVP circuits trip, LEDs on the front panel light to indicate the failure. This status can also be read back to the computer over the HP-IB and can be used to generate interrupts.

### Specifications

Ratings		Autoranging Output*							Regulation				10% Change Transient Recovery	
									Load Effect		Source Effect		Time	Level
Volts	Amperes	V <sub>1</sub>	P <sub>1</sub>	V <sub>2</sub>	P <sub>2</sub>	V <sub>3</sub>	P <sub>3</sub>	HP Model	Voltage	Current	Voltage	Current		
0-20	0-30	20V	200W	14V	242W	6.7V	200W	6033A	0.01% +2mV	0.01% +9mA	0.01% +1mV	0.01% +6mA	1ms 50mV	
0-20	0-120	20V	1000W	14V	1064W	7V	840W	6031A†	0.01% +3mV	0.01% +15mA	0.01% +2mV	0.01% +25mA	2ms 100mV	
0-60	0-10	60V	200W	40V	240W	20V	200W	6038A	0.01% +3mV	0.01% +5mA	0.01% +2mV	0.01% +2mA	1ms 75mV	
0-60	0-50	60V	1000W	40V	1200W	20V	1000W	6032A†	0.01% +5mV	0.01% +10mA	0.01% +3mV	0.01% +10mA	2ms 100mV	
0-200	0-17	200V	1000W	120V	1200W	60V	1020W	6030A†	0.01% +5mV	0.01% +10mA	0.01% +5mV	0.01% +5mA	2ms 150mV	
0-500	0-5	500V	1000W	350V	1050W	200V	1000W	6035A†	0.01% +13mV	0.03% +34mA	0.01% +13mV	0.03% +17mA	5ms 200mV	

\*See the generalized autoranging output characteristic curve.

†HP Models 6030A, 6031A, 6032, and 6035A are equipped with barrier block connectors to attach user supplied line cord.

**Programmable Features**

Below are the parameters which can be programmed on the HP 6030A — 6038A and the information which is available for readback over the HP-IB. All of these features are included with the standard programming language or TMSL (Test and Measurement Systems Language).

**Programmable Functions**

- Output Voltage
- Output Current
- Output Disable/Enable
- Soft Voltage Limit
- Soft Current Limit
- Group Trigger
- Foldback Mode
- Device Clear
- Interrupt Mask
- Interrupt Delay
- Preset Power Supply States
- Self-Test
- Local Lockout

**Readback Functions**

- Programmed Voltage
- Programmed Current
- Actual Voltage
- Actual Current
- OVP Trip Level
- Soft Voltage Limit
- Soft Current Limit
- Foldback Mode
- Present Status
- Accumulated Status
- Interrupt Mask
- Programming Error Codes
- Self Test Error Codes
- Output Disable/Enable
- Device ID

**System Configuration**

Up to 16 power supplies can share one HP-IB address, while still providing full independent control, when connected with a modular telephone-style cable. (This feature requires programming in TMSL mode.) To use this feature you will also need to order a serial link cable for each unit to be added to the chain, with the first unit connected directly to HP-IB. The standard serial link cable is 2 meters (6.6').

If your application requires more power than the output capability of a single unit, you can use an auto-series connection for greater output voltage or an auto-parallel connection for greater output current. Consult your local HP sales office regarding restrictions/limitations for auto-series and auto-parallel operation.

Remote sensing can be used to maintain the CV load effect specification at the load with up to 0.5 volt drop per load lead, and sense wires which are less than 0.2 ohm per lead. Operation is possible with up to 2.0 volts drop per lead; however, the load effect specification may be degraded.

Either terminal may be grounded, or may be floated up to ± 240 (± 550 volts for the HP 6030A and 6035A) volts from chassis ground.

Analog programming inputs and monitoring terminals are provided on the rear panel in addition to the HP-IB programming capabilities. Zero to full scale voltage or current can be programmed with either 0-5 volt voltage signals, or 0-4000 ohm resistance signals. The monitoring terminals present 0-5 volt buffered signals which are proportional to the output voltage and current.

HP models 6030A, 6031A, 6032A, 6035A, and 6038A are stable when operating in CC into inductive loads up to 100 mH, and the HP 6033A and 6038A can handle up to 1 H. A special modification is available for HP Models 6030A, 6031A and 6032A to ensure stable operation when operating into inductive loads up to 10 H.

**General Specifications**

HP-IB interface functions: SH1, T6, AH1, L4, SR1, RL1, PP1, DC1, DT1.

Dimensions: HP 6033A and 6038A: 177.0 mm H x 212.3 mm W x 443.6 mm D (6.97" x 8.36" x 17.872")

HP 6030A, 6031A, 6032A and 6035A: 132.6 mm H x 425.5 mm W x 503.7 mm D (5.2" x 16.75" x 19.83")

**Specifications cont.**

PARD (rms/p-p) 20 Hz-20 MHz	HP-IB Output Settings						General						
	Resolution		Accuracy**				AC Input Current				Weight - kg (lbs)		Price
	Voltage	Current	Voltage	Current	Voltage	Current	100 Vac	120 Vac	220 Vac	240 Vac	Net	Shipping	
3mV/30mV	15mA/-	5mV	7.5mA	0.035% +9mV	0.15% +20mA	6.0A	6.5A	3.8A	3.6A	9.6(21)	11.4(25)	\$2700	
8mV/50mV	120mA/-	5mV	30mA	0.035% +15mV	0.25% +250mA	24A	24A	15A	14A	17.2(38)	22.7(50)	\$3750	
3mV/30mV	5mA/-	15mV	2.5mA	0.035% +40mV	0.085% +10mA	6.0A	6.5A	3.8A	3.6A	9.6(21)	11.4(25)	\$2700	
8mV/40mV	25mA/-	15mV	12.5mA	0.035% +40mV	0.2% +85mA	24A	24A	15A	14A	16.3(36)	21.8(48)	\$3750	
22mV/50mV	15mA/-	50mV	4.25mA	0.035% +145mV	0.2% +25mA	24A	24A	15A	14A	16.3(36)	21.7(48)	\$3750	
50mV/160mV	50mA/-	125mV	1.25mA	0.25% +400mV	0.3% +85mA	24A	24A	15A	14A	16.3(36)	21.7(48)	\$4100	

\*\*For a ±5°C range about the calibration temperature.

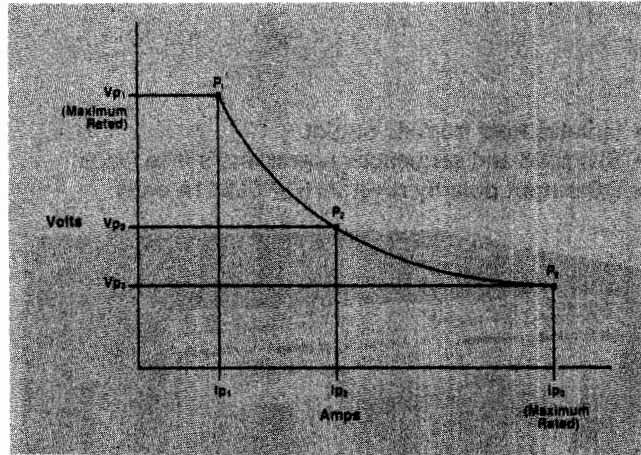

Generalized autoranging output characteristic curve

Warranty period: Three years.

**Fault Indicator and Remote Inhibit**

These HP-IB DC power supplies include a discrete fault indicator line (FLT) and remote inhibit line (INH). FLT is a two pin TTL output port that will go true whenever the power supply goes into fault mode. INH is a two pin TTL input port that provides a means for disabling the power supply directly. Both the Fault Indicator and Remote Inhibit Lines are separate from, and in addition to, the HP-IB programming control.

**Isolation/Polarity Reversal Relay Control**

These models can control HP Models 59510A, 59511A relay devices with HP-IB commands. This applies to HP 603XA series products manufactured after May 1, 1988. Consult HP regarding retrofit kit for older HP 603XA series power supplies. See page 488 for more details.

**Option Descriptions**

- Opt 001** Front panel which has only line switch, line indicator, and OVP adjust. -\$300
- Opt 100** 87-106 Vac, 48-63 Hz. This option is for use in Japan only. The power supply output power is 75% of the output power available with the other line voltage options. \$0
- Opt 220** 191-233 Vac, 48-63 Hz. \$0
- Opt 240** 208-250 Vac, 48-63 Hz. \$0
- Opt 800** Rack mount kit for two units side by side. This applies to HP 6033A and 6038A only. +\$79
- Opt 908** Rack mount kit for a single unit. A blank filler panel is supplied when this option is ordered with HP 6033A and 6038A. +\$84
- HP 6033A and 6038A +\$35
- HP 6030A, 6031A, 6032A and 6035A \$85
- Opt 909** Rack mount kit with handles for HP Models 6030A, 6031A, 6032A, 6035A +\$32
- Opt 910** One extra operating and service manual shipped with each power supply. +\$32

**Accessory**

- HP 5080-2148** serial link cable, 2m (6.6') \$6

# POWER SUPPLIES

## DC Output Connect/Disconnect and Polarity Reversal Relay Accessories

HP 59510A, 59511A

- Isolates load from dc output
- Switches and sequences power and sense leads
- DC output polarity reversal (HP 59511A only)

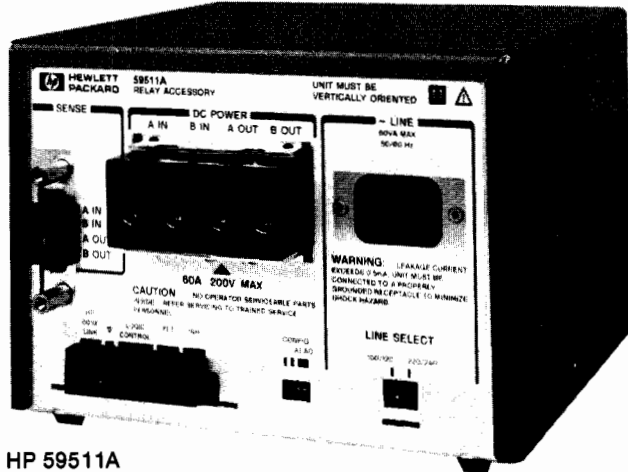

HP 59511A

### Relay Devices

The HP 59510A and 59511A are remote controllable relay devices. These power supply accessories can be configured to switch dc power to multiple test fixtures or can be used to provide extra protection when a fault condition requires emergency shut-down. Each unit switches one power supply output. These relays can be used with any dc power supply within the voltage and current limits. The HP 59511A has all of the features of the HP 59510A and also provides relays for polarity reversal.

An internal microprocessor sequences the switching of power and sense leads. This protects the load by minimizing possible voltage overshoots. When used with HP system power supplies that are configured appropriately (see table on this page), the relays can be controlled through the power supply HP-IB port. For other applications, the HP 59510A and 59511A are controlled through a TTL signal port.

### Configuring HP Power Supplies for Relay Control

The following table shows the HP power supplies that can be ordered with rear panel connections for direct control of HP 59510A and 59511A.

HP Power Supply	Power Supply Option	Relay Devices Controlled
HP 6621A-6629A	750	4 HP 59510A relays or 2 HP 59511A relays
HP 6632A-6634A	760	This option includes built-in relay devices
HP 6651A-6655A	std	1 HP 59510A or 59511A
HP 6030A-6038A	std*	1 HP 59510A or 59511A

\* Models manufactured before May 1, 1988, do not have this capability. Contact your HP sales office for retrofit information.

### Mounting

Both relay accessory models can be mounted on any one of three sides to a flat surface with the PEM fasteners provided. The rack mount kit (option 850) eases mounting behind the power supply or toward the front of the equipment rack.

### Specifications

**Operating ranges:** 200V at 20A, or 120V at 30A, or 48V at 60A.

**Isolation:** input to output: 200 Vdc

input/output to ground: 500 Vdc

TTL control to ground: 240 Vdc

**Settling time (TTL control):** connect 440 msec, disconnect 160 ms, polarity reversal 600 ms

**DC voltage drop (at 60A):** 0.5 volts maximum on each relay

**AC input:** equipped with a line module settable to nominal 100, 120, 220, or 240 Vac (-13% 6%), 48-63 Hz

### Weight:

**HP 59510A:** net, 2.3kg (5lb); shipping, 3.6kg (8lb); shipping with option 850, 4.1kg (9lb)

**HP 59511A:** net, 3.6kg (8lb); shipping, 5.0kg (11 lb); shipping with option 850, 5.5kg (12lb)

**Mounting orientation:** within  $\pm 10$  deg from vertical.

**Size:** 130.6H x 185.4W x 198.6mmD (5.14" x 7.26" x 7.81")

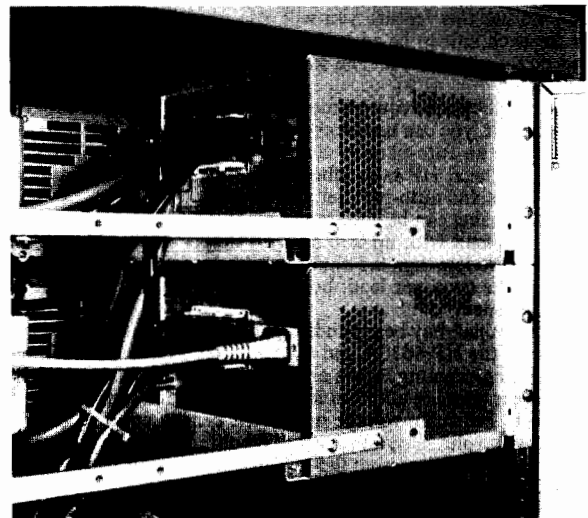

The relay accessories can be mounted behind power supplies using the option 850 rack mounting kit. The device can be oriented in any horizontal position on the tray. The orientation shown above can be used in shallow racks with no space to run cables from the relay accessory to the rear of the rack.

### Options

**Option 850** is a rackmount kit to facilitate mounting relay accessories. Side-by-side mounting of two devices requires two kits. For side-by-side mounting, adequate clearance is required so that the rear-exiting cables fit inside the rear wall or door of the rack. The clearance needed varies according to the flexibility of the user supplied cables. Approximately four inches from the relay accessory panel is usually adequate.

**Option 910** is one extra operating and service manual.

### Ordering Information

	Price
HP 59510A Output Isolation Relay Accessory	\$1050
HP 59511A Output Isolation/Polarity Reversal Relay Accessory	\$1400
Opt 850 Rackmount Kit	+\$77
Opt 910 extra Operating and Service Manual	+\$26



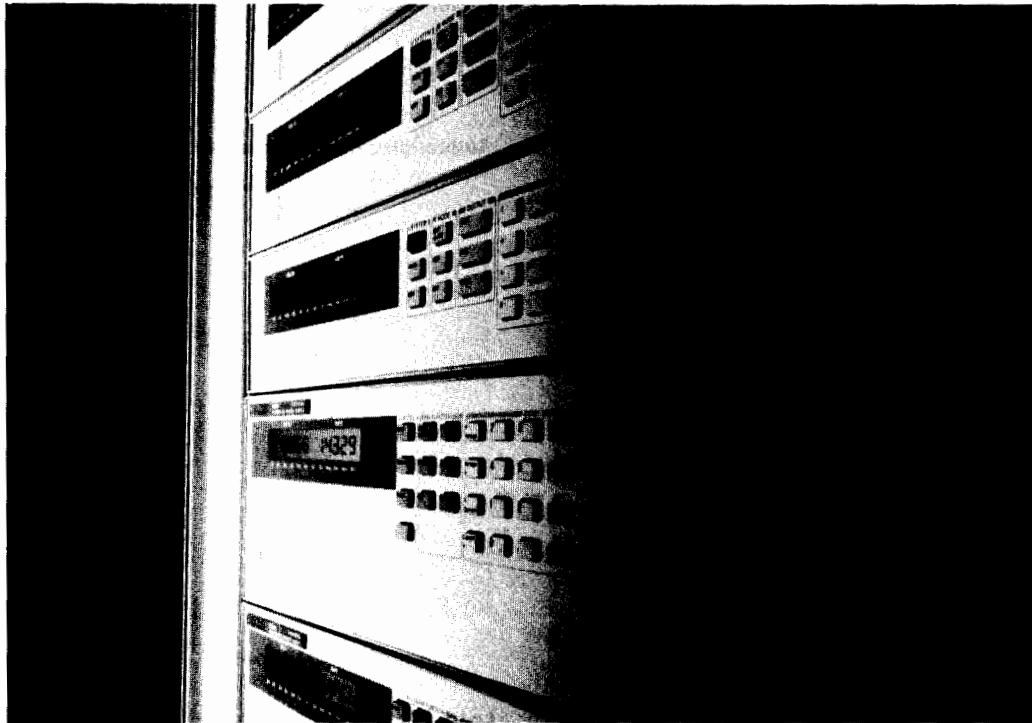

HP 14921A

### HP 14921A Power Supply Calibration Software

The HP 14921A power supply calibration software, together with the specified HP test equipment, automates the performance testing and alignment of Hewlett-Packard 6600 Series system power supplies. This includes models HP 6621A-6629A, 6632A-6634A, and 6651A-6655A.

The software runs on any HP 9000, Series 300 controller, and it is compatible with HP BASIC versions 5.XX. It includes an INSTALL program for easy installation. The menu system makes selecting tests, modifying the hardware configuration, and printing test records easy.

The HP 14921A power supply calibration software will be especially useful in large installations of Hewlett-Packard system power supplies, where regular calibration cycles are performed. For these installations, productivity will be greatly improved by using the software and associated hardware system.

The performance specifications that are tested include:

- CV and CC line regulation
- CV and CC load regulation
- CV, CC, and OVP programming accuracy
- CV and CC readback accuracy
- CV p-p ripple and noise
- Up and down programming speed
- Transient settling time

Alignment of programming and readback accuracy can also be performed.

### Required Hardware

The following hardware is required to run the HP 14921A calibration software. The program does not permit substitutions.

### Controller

- HP 9000 Series 300 workstation
  - HP BASIC 5.XX Language System
  - 2 Mbyte RAM Memory
  - Hard disk drive recommended
  - HP ThinkJet or HP QuietJet HP-IB printer (optional)

### Instruments

- HP 3458A digitizing DMM
- HP 3488A switch control unit
- HP 44471A relay actuator
- HP 44472A VHF switch
- HP 6030A power supply
- HP 6050A electronic load mainframe
- HP 60503A high voltage load module (for up to 240 V and 10 A)
- HP 60504A high power load module with special option J10 (for up to 120 V and 60 A)
- HP 59510A relay accessories
  - (3 HP 59510A for a system with 1 load module, 4 HP 59510A for a system with both load modules)
- AC Source
  - (15 amp variable transformer)
- Precision Current Shunts
  - 0.1 ohm, 0.04%, 15 amp, 25 watt (Guildline 9230/15). For testing models HP 6651A and 6652A only: 0.01 ohm, 0.04%, 100 amp, 100 watt (Guildline 9230/100)

### Ordering Information

HP 14921A power supply calibration software

### Price

\$1,200

Note for A.00.00 users, contact your local HP sales office for upgrade kit to support HP 8651A and HP 8655A.

# POWER SUPPLIES

## 200 Watt System Power Supply

### HP 6002A

- 200 watt autoranging dc output
- Constant-voltage/constant-current operation
- HP-IB programming option

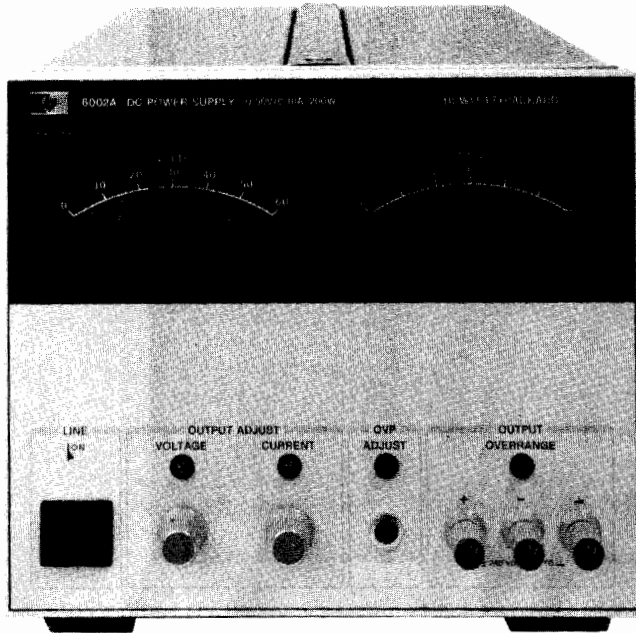

HP 6002A

### Description

The HP 6002A dc power supply offers an exceptional combination of performance and flexibility. It employs a unique control concept which provides for an autoranging output with the performance characteristics of linear regulation. The HP 6002A is a 200 watt CV/CC power supply, which may be remotely programmed via the HP-IB when equipped with Option 001.

As an autoranging power supply, the HP 6002A can provide 200 watts over a wide range of voltage and currents without external intervention. This allows it to take the place of multiple conventional power supplies. For example, the HP 6002A can replace both a 50 volt, 4 ampere supply and a 20 volt, 10 ampere supply.

### System Features/Remote Control

Analog programming of output voltages and current can be accomplished through the use of remotely controlled resistance or voltage applied to rear panel terminals. Additional control terminals are provided for remote load voltage sensing, auto-series or parallel operation, and for remotely activating the crowbar circuit. A pulse output from the crowbar terminal indicates the overvoltage circuit has been self-activated. A voltage step change appearing on terminal indicates a changeover to or from constant-current operation.

### HP-IB Option

Digital programming via Option 001 permits control of output voltage or current by the Hewlett-Packard Interface Bus (HP-IB). Two programmable ranges allow better resolution below 10 volts or 2 amperes. The selection of HP-IB control of either voltage or current is done by rear panel switches. The IEEE 488 interface functions supported by the HP 6002A with Option 001 are basic listener (L2) and acceptor handshake (AH1). Complete explanation of these interface functions is available in the IEEE Std. 488-1978.

### Specifications

**DC output:** voltage and current output can be adjusted over the ranges indicated by front panel controls, analog programming, or an optional HP-IB interface.

**Voltage:** 0–50 V. **Current:** 0–10 A.  
Maximum 200 watts output from 20 V to 50 V.

- Built-in overvoltage protection crowbar
- CV/CC operating status indicators
- Remote analog programming and sensing

### Autoranging Output Characteristic

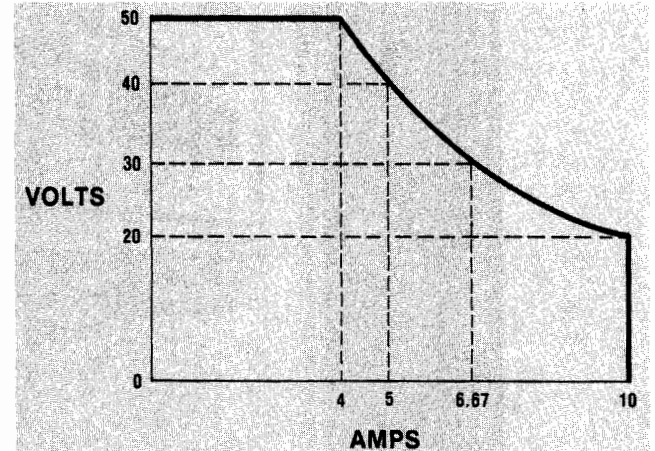

**Load effect:** constant-voltage, 0.01% +1 mV. Constant-current, 0.01% +1 mA.

**Source effect:** CV, 0.01% +1 mV; CC, 0.01% +1 mA.

**Ripple and noise (PAR):** rms/p-p, 20 Hz to 20 MHz; CV, 1 mV/10 mV; CC, 5 mA rms.

**Temperature coefficient:** CV, 0.02% +200  $\mu$ V/°C; CC 0.02% +5 mA/°C.

**Drift:** CV, 0.05% +1 mV/8 h; CC, 0.05% +5 mA/8 h.

**Load transient recovery:** 100  $\mu$ s for output voltage to recover within 15 mV of nominal voltage setting following a load current change of 50% to 100% or 100% to 50% of full load current.

**Response time:** maximum time for output voltage to change between 0 to 99.9% or 100% to 0.1% of maximum rated output voltage. Up Programming: no load, 100 ms; full load, 100 ms. Down Programming: no load, 400 ms; full load, 200 ms.

**Overvoltage protection:** trip voltage adjustable from 2.5 V to 60 V. **DC output isolation:** 150 V dc.

**Power:** 100, 120, 220, or 240 V ac (–13%, +6%), 48-63 Hz.

**Temperature rating:** 0°C to 55°C operating, –40°C to +75°C storage. Supply is cooled by built-in fan.

**Size:** 180 H x 212 W x 422 mm D (6.97" x 8.36" x 16.6").

**Weight:** net, 14.5 kg (32 lb); shipping, 15.9 kg (35 lb).

### HP-IB Option

**Programmable ranges:** high: 0–50 V or 0–10 A,  
low: 0–10 V or 0–2 A.

**Programming speed:** same as response time.

**Accuracy:** hi range: CV, 0.2% +25 mV; CC, 0.2% +25 mA.  
lo range: CV, 0.2% +10 mV; CC, 0.2% +25 mA.

**Resolution:** hi range: CV, 50 mV; CC, 10 mA. (12 bit)  
lo range: CV, 10 mV; CC, 2 mA. (12 bit)

**Isolation:** 250 volts dc from bus data lines to power supply.

### Order Information

Order Information	Price
HP 6002A Autoranging dc Power Supply	\$2575
Opt 001: HP-IB interface	+\$585
Opt 800: rack flange kit to mount 2 locked HP 6002As	+\$79
Opt 908: rack mounting adapter kit for one HP 6002A; includes blank filler panel.	+\$84
Opt 910: one extra operating and service manual	+\$10

- HP-IB power supply control
- HP-IB-to-power-supply isolation
- Programmable range

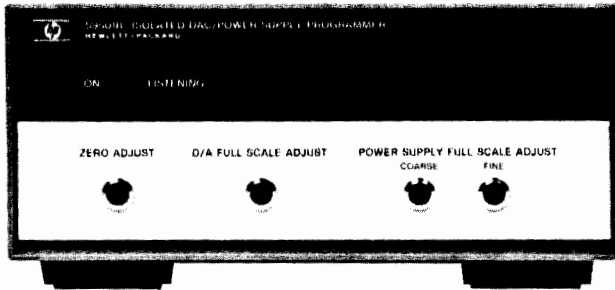

HP 59501B



### Description

The HP 59501B is an isolated digital-to-analog converter designed to provide a convenient interface between the Hewlett-Packard Interface Bus and HP power supplies. With the HP 59501B, a wide range of dc voltages and currents becomes automatically controllable via the HP-IB. With proper wiring, the built-in isolation devices protect other instrumentation on the HP-IB from damage that could be caused by power supply outputs. In addition, an internal control circuit holds the output level near zero until programmed data is received. A programmable High/Low range control improves resolution by ten-to-one.

Power supply control is accomplished through the HP 59501B's programmable output voltage and programming network (see below). By making the appropriate connections between the 59501B's rear terminals and the remote programming terminals on the supply, the output voltage (or current) of the supply can be programmed from zero to its full rated output. The HP 59501B front panel controls provide fast and easy calibration of power supply outputs. The Zero Adjust enables the user to correct for small offsets in power supply response to programmed inputs. The Power Supply Full Scale Adjust (part of programming network) enables the user to set the maximum output desired from the power supply when the HP 59501B is programmed to its maximum value. For example, this adjustment would normally be used to calibrate the maximum programmable output of a 320Vdc power supply to 320 volts. However, it could also be used to set the maximum to 200 volts.

The HP 59501B also can be used directly as a low level dc signal source. Unipolar and bipolar output modes are available with output voltages programmable from zero to 9.99 volts, or minus 10.0 to plus 9.98 volts. Output current up to 10 milliamperes is available and is automatically limited to protect the HP 59501B and user equipment. The HP 59501B produces a full scale voltage change in approximately 250  $\mu$ s from the time the digital data is received.

- Programmable 10-volt dc output
- Unipolar/bipolar operation
- Fast digital to analog conversion

### Specifications

#### Digital to Analog Converter

**DC output voltage:** programmable in high or low ranges within the voltage limits shown below. Output mode is unipolar or bipolar and is selected by a rear panel switch.

**Unipolar:** 0 to 9.99 V (low range, 0 to 0.999 V).

**Bipolar:** -10 to +9.98 V (low range, -1 to +0.998 V).

**DC output current:** 10 mA maximum.

**Ripple and noise (PARD):** 2 mV rms/10 mV p-p.

**Resolution:** unipolar, 10 mV (low range, 1 mV). Bipolar, 20 mV (low range, 2 mV).

**Accuracy:** specified at 23°C  $\pm$  5°C.

**Unipolar:** 0.1% + 5 mV (low range, 0.1% + 1 mV).

**Bipolar:** 0.1% + 10 mV (low range, 0.1% + 2 mV).

**Stability:** change in output over 8 hour interval under constant line, load, and ambient following a 30 minute warm-up. Stability is included in accuracy specification measurements over the temperature range indicated.

**Unipolar:** 0.04% + 0.5 mV (low range, 0.04% + 0.1 mV).

**Bipolar:** 0.04% + 1 mV (low range, 0.04% + 0.2 mV).

**Temperature coefficient:** unipolar, 0.01%/°C + 0.5 mV/°C (low range, 0.1%/°C + 0.1 mV/°C). Bipolar, 0.01%/°C + 0.5 mV/°C (low range, 0.01%/°C + 0.1 mV/°C).

**Zero adjust:** plus or minus 250 millivolts.

**D/A full scale adjust:** plus or minus 5%.

**Programming speed:** the time required for output to go from zero to 99% of programmed output change is 250  $\mu$ s (measured with resistive load connected to output terminals).

#### Power Supply Programming

**Programming network specifications:** in the following specifications, M represents the calibrated full scale value of the supply being programmed and P is the actual programmed output. The full scale value (M) can be any value within the supply's output range and is calibrated with the HP 59501B programmed to its maximum high range output.

**Accuracy:** specified at 23°C  $\pm$  5°C.

**Unipolar:** 0.05% M + 0.25% P (low range, 0.01% M + 0.25% P).

**Bipolar:** 0.1% M + 0.25% P (low range, 0.02% M + 0.25% P).

**Isolation:** 600 V dc between HP-IB data lines and output terminals.

**Temperature coefficient:** 0.005% M/°C + 0.015% P/°C (low range, 0.01% M/°C + 0.015% P/°C).

**Programming resolution:** 0.1% M (low range, 0.01% M).

**Programming speed:** D/A programming speed plus the programming speed of the power supply.

#### General

**Temperature range:** operation, 0 to 55°C; storage, -40 to 75°C.

**Power:** 100, 120, 220, or 240 Vac (+6% -13%) 47-63 Hz, 10 VA (selectable on rear panel).

**Size:** 101.6 H x 212.9 W x 294.6 mm D (4" x 8.38" x 11.6").

**Weight:** net, 1.82 kg (4 lb); shipping, 2.27 kg (5 lb).

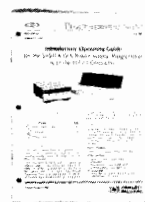
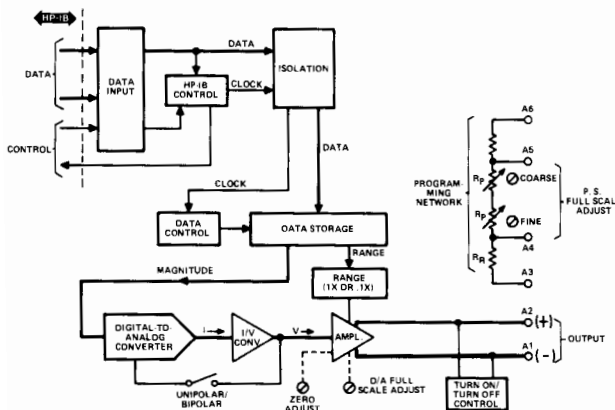

Several programming notes are available to assist in operating the HP 59501B Power Supply Programmer with the HP desktop computers. For more on free publications, see 760.

#### Ordering Information

HP 59501B HP-IB Isolated D/A Power Supply Programmer

Price  
\$1000

#### Accessories

HP 5060-0173: rack mounting adapter kit for one HP 59501B

\$85

HP 5060-0174: rack mounting adapter kit to connect two HP 59501B's

\$75

☎ For same-day shipment, call HP Direct at 800-538-8787

# POWER SUPPLIES

General Purpose: 25–200 W Output

HP 6227B–6299A

- Constant voltage/constant current operation
- Remote sensing and programming
- Auto-series, -parallel, & -tracking operation

- Front and rear output terminals
- Floating output—use as positive or negative source
- Bench or rack mounting

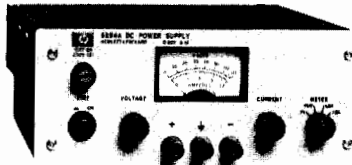

HP 6281A, 6284A, 6289A,  
6294A, 6299A

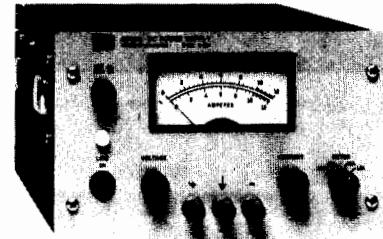

HP 6282A, 6286A,  
6291A, 6296A

## Description

### HP 6281A–6299A Single Output

This series of medium-power constant voltage/constant current power supplies is available in two power ranges: 37–75 watts (packaged in 3½-inch high half-rack cases) and 100–200 watts (packaged in 5¼-inch high half-rack cases). All models except HP 6294A and 6299A have separate coarse and fine voltage and current controls that allow the voltage and current outputs to be varied from zero to the maximum rated values. The latter two models have ten-turn voltage controls. Crossover from constant voltage to constant current operation occurs automatically when the load current exceeds the value established by the current control settings. A four-position meter function switch selects either of two output voltage or output current ranges (X1, X0.1) for display on the panel meter.

The 37–75 watt models are of the series-regulated type. They have excellent regulation and ripple characteristics and include a special output-capacitor discharge circuit for improved programming speed. The 100–200 watt models employ a series-regulator/SCR-preregulator configuration to achieve the high efficiency necessary for a convection-cooled package of this size. They also have excellent regulation, low ripple and noise, and moderate programming speeds.

### HP 6253A and 6255A Dual Output

These versatile dual-output models each contain two identical, independently adjustable 60 watt power supplies in a full-rack width case. The regulator, voltage and current control, and metering circuits of each section of the supply are electrically identical to those of the individual 37–75 watt models described above.

By combining the versatility of a dual power supply with the flexibility of auto-series and auto-parallel operation, twice the maximum rated output voltage or current of each section can be obtained from the one supply. In addition, using the supply's auto-tracking capability, opposite-polarity voltages ( $\pm 20$  V for HP 6253A or  $\pm 40$  V for HP 6255A) are possible.

### HP 6227B and 6228B Dual Output

These versatile lab supplies each house two identical 50 W regulated power supplies. A convenient front panel switch selects either independent or tracking operation. In the track mode, the right supply tracks the left within  $0.2\% \pm 2$  mV. The tracking mode is especially useful for powering operational amplifiers, push-pull stages, deflection systems, or any application where plus and minus voltages must track with insignificant error. The independent mode permits operation of the two supplies individually, in auto-parallel or in auto-series.

## Specifications

RATINGS			PERFORMANCE							
DC Output		HP Model	Load Effect		Source Effect		Ripple & Noise (PARD) (rms/p-p)		Drift (stability)	
Volts	Ampere		Voltage	Current	Voltage	Current	Voltage	Current	Voltage	Current
0–7.5	0–5	6281A	5 mV	0.01% + 250 $\mu$ A	0.01% + 2 mV	0.01% + 250 $\mu$ A	200 $\mu$ V/1 mV	4 mA rms	0.1% + 2.5 mV	0.1% + 12.5 mA
0–10	0–10	6282A	0.01% + 1 mV	0.05% + 1 mA	0.01% + 1 mV	0.05% + 1 mA	500 $\mu$ V/25 mV	5 mA rms	0.1% + 2.5 mV	0.1% + 25 mA
0–20	0–3	6253A*	0.01% + 4 mV	0.01% + 250 $\mu$ A	0.02% + 2 mV	0.01% + 250 $\mu$ A	200 $\mu$ V/1 mV	2 mA rms	0.1% + 2.5 mV	0.1% + 7.5 mA
0–20	0–3	6284A	0.01% + 4 mV	0.01% + 250 $\mu$ A	0.01% + 2 mV	0.01% + 250 $\mu$ A	200 $\mu$ V/1 mV	2 mA rms	0.1% + 2.5 mV	0.1% + 7.5 mA
0–20	0–10	6286A	0.01% + 1 mV	0.05% + 1 mA	0.01% + 1 mV	0.05% + 1 mA	500 $\mu$ V/25 mV	5 mA rms	0.1% + 2.5 mV	0.1% + 25 mA
0–25	0–2	6227B*	0.01% + 1 mV	0.01% + 250 $\mu$ A	1 mV	100 $\mu$ A	250 $\mu$ V/4 mV	250 $\mu$ A/2 mA	0.2% + 2 mV	0.2% + 3 mA
0–40	0–1.5	6295A*	0.01% + 2 mV	0.01% + 250 $\mu$ A	0.01% + 2 mV	0.01% + 250 $\mu$ A	200 $\mu$ V/1 mV	500 $\mu$ A rms	0.1% + 2.5 mV	0.1% + 4 mA
0–40	0–1.5	6289A	0.01% + 2 mV	0.01% + 250 $\mu$ A	0.01% + 2 mV	0.01% + 250 $\mu$ A	200 $\mu$ V/1 mV	500 $\mu$ A rms	0.1% + 2.5 mV	0.1% + 4 mA
0–40	0–5	6291A	0.01% + 1 mV	0.05% + 1 mA	0.01% + 1 mV	0.05% + 1 mA	500 $\mu$ V/25 mV	3 mA rms	0.1% + 2.5 mV	0.1% + 12.5 mA
0–50	0–1	6228B*	0.01% + 1 mV	0.01% + 250 $\mu$ A	1 mV	100 $\mu$ A	250 $\mu$ V/4 mV	250 $\mu$ A/2 mA	0.2% + 2 mV	0.2% + 1.5 mA
0–50	0–1	6294A	0.01% + 2 mV	0.01% + 250 $\mu$ A	0.01% + 2 mV	0.01% + 250 $\mu$ A	200 $\mu$ V/1 mV	500 $\mu$ A rms	0.1% + 2.5 mV	0.1% + 2.5 mA
0–60	0–3	6296A	0.01% + 1 mV	0.05% + 1 mA	0.01% + 1 mV	0.05% + 1 mA	500 $\mu$ V/25 mV	3 mA rms	0.1% + 2.5 mV	0.1% + 7.5 mA
0–100	0–0.75	6299A	0.01% + 2 mV	0.01% + 250 $\mu$ A	0.01% + 2 mV	0.01% + 250 $\mu$ A	200 $\mu$ V/1 mV	500 $\mu$ A rms	0.1% + 2.5 mV	0.1% + 2 mA

\*Models 6227B, 6228B, 6253A, and 6255A contain two identical, independently-adjustable power supplies.

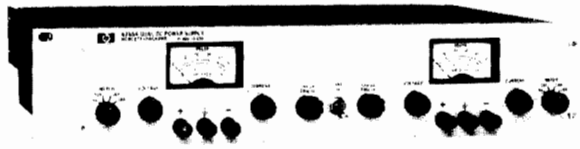

HP 6253A, 6255A



HP 6227B, 6228B

Each side of the dual supply can be operated as a constant voltage or constant current source, and each has its own crowbar for overvoltage protection. In the tracking mode, an overvoltage condition in either supply trips both crowbars. The power supply outputs are isolated up to 300 V from output to chassis or output to output.

**Specifications—General**

**Load effect transient recovery:** time, 50  $\mu$ s; level, 15 mV.  
**Meter accuracy:** 3% of full scale.  
**Power:** standard input voltage is 115 V ac  $\pm$  10%. Order Option 028 for 230 V ac  $\pm$  10% operation. Input power frequency, maximum input current, maximum power consumption are:  
 HP 6227B and 6228B, 48–63 Hz, 2.7 A, 260 W;  
 HP 6253A, 48–440 Hz, 2.6 A, 235 W; HP 6255A, 48–440 Hz, 2.6 A, 235 W; HP 6281A, 48–440 Hz, 1.3 A, 118 W; HP 6282A, 57–63 Hz, 3.5 A, 200 W; HP 6284A, 48–440 Hz, 1.5 A, 128 W; HP 6286A, 57–63 Hz, 5.5 A, 320 W; HP 6289A, 48–440 Hz, 1.3 A, 110 W; HP 6291A, 57–63 Hz, 5.5 A, 280 W; HP 6294A, 48–440 Hz, 1.3 A, 114 W; HP 6296A, 57–63 Hz, 4.5 A, 250 W; HP 6299A, 48–440 Hz, 1.5 A, 135 W.  
**Size:** 6227B, 6228B: 155 H x 197 W x 309.55 mm D (6 $\frac{1}{32}$ " x 7 $\frac{7}{32}$ " x 12 $\frac{7}{16}$ ").  
 HP 6253A, 6255A: 87 H x 483 W x 403 mm D (3 $\frac{7}{16}$ " x 19" x 15 $\frac{7}{8}$ ").  
 HP 6281A, 6284A, 6289A, 6294A, 6299A: 87 H x 209 W x 398 mm D (3 $\frac{7}{16}$ " x 8 $\frac{1}{32}$ " x 15 $\frac{7}{8}$ ").  
 HP 6282A, 6286A, 6291A, 6296A: 131 H x 210 W x 435 mm D (5 $\frac{1}{2}$ " x 8 $\frac{1}{4}$ " x 17 $\frac{1}{8}$ ").

**Option Descriptions**

See list under "Options" in table below for availability.  
**005:** 50 Hz ac input: optimizes power supplies that require adjustment/modification for 50 Hz operation. \$0  
**010:** Chassis slides. Enable convenient access to rack-mounted power supply for maintenance. + \$90

**011:** Internal overvoltage protection crowbar. Protects sensitive loads against power supply failure or operator error. Monitors the output voltage and places a virtual short circuit (conducting SCR) across load after preset trip voltage is exceeded.

- HP 6281A, 6284A, 6289A, 6294A, 6299A +\$132.00
- HP 6253A, 6255A, 6282A, 6286A, 6291A, 6296A +\$215.00
- 028:** 230 Vac  $\pm$  10%, single-phase input. Factory modification reconnects the multi-tap input power transformer for 230 V operation. \$0
- 040:** Interfacing for Multiprogrammer operation. Prepares standard HP power supplies for resistance programming by the HP 6942A, 6944A or 6954A. Single-output models +\$80.00  
 Dual-output models +\$158.00
- 010:** one additional operating and service manual shipped with the power supply
- HP 6227 +\$10.00
- HP 6253A, 6255A, 6228B +\$7.88
- HP 6281A, 6282A, 6284A, 6286A, 6289A, 6291A, 6294A, 6296A, 6299A +\$5.35

**Accessories**

- HP 14513A: 3.5 in. high rack kit for one HP 6281A, 6284A, 6289A, 6294A, 6299A \$90
- HP 14523A: 3.5 in. high rack kit for two above supplies \$50
- HP 14515A: 5.25 in. high rack kit for one HP 6282A, 6286A, 6291A, 6296A \$110
- HP 14525A: 5.25 in. high rack kit for two above supplies \$50
- HP 5060-8760: blank filler panel for HP 6227B, 6228B \$44
- HP 5060-8762: adapter frame for rack mounting one or two HP 6227B, 6228B \$150

**Specifications, continued**

REMOTE CONTROL FEATURES								GENERAL						
Resistance Coefficient		Voltage Coefficient		Speed, UP*		Speed, DOWN*		Overvoltage		Weight			Options $\Delta$	Price
Voltage	Current	Voltage	Current	NL	FL	NL	FL	Range	Margin	Net	Shipping			
200 $\Omega$ /V $\pm$ 1%	200 $\Omega$ /A $\pm$ 10%	1 V/V $\pm$ 1%	0.2 V/A $\pm$ 10%	1 ms	2 ms	10 ms	6 ms	2.5–10 V	4% + 2 V	6.4 kg/14 lb	7.2 kg/16 lb	11, 28, 40	\$1100	
200 $\Omega$ /V $\pm$ 1%	100 $\Omega$ /A $\pm$ 10%	1 V/V $\pm$ 1%	100 mV/A $\pm$ 10%	70 ms	200 ms	9 s	40 ms	1–13 V	7% + 1 V	11.3 kg/25 lb	13.6 kg/30 lb	5, 11, 28, 40	\$1380	
200 $\Omega$ /V $\pm$ 1%	500 $\Omega$ /A $\pm$ 10%	1 V/V $\pm$ 1%	0.33 V/A $\pm$ 10%	30 ms	80 ms	400 ms	100 ms	2.5–23 V	4% + 2 V	12.7 kg/28 lb	17.7 kg/39 lb	10, 11, 28, 40	\$1900	
200 $\Omega$ /V $\pm$ 1%	500 $\Omega$ /A $\pm$ 10%	1 V/V $\pm$ 1%	0.33 V/A $\pm$ 10%	30 ms	80 ms	400 ms	100 ms	2.5–23 V	4% + 2 V	6.4 kg/14 lb	7.2 kg/16 lb	11, 28, 40	\$1000	
200 $\Omega$ /V $\pm$ 1%	100 $\Omega$ /A $\pm$ 10%	1 V/V $\pm$ 1%	100 mV/A $\pm$ 10%	150 ms	150 ms	9 s	70 ms	2–22 V	7% + 1 V	10.8 kg/26 lb	13.1 kg/29 lb	5, 11, 28	\$1450	
200 $\Omega$ /V $\pm$ 1%	500 $\Omega$ /A $\pm$ 10%	1 V/V $\pm$ 1%	.5 V/A $\pm$ 10%	40 ms	200 ms	400 ms	75 ms	5–28 V	7% + 1.5 V	11 ka/24 lb	12.9 kg/28 lb	40	\$2250	
200 $\Omega$ /V $\pm$ 1%	500 $\Omega$ /A $\pm$ 10%	1 V/V $\pm$ 1%	0.66 V/A $\pm$ 10%	15 ms	45 ms	200 ms	40 ms	2.5–44 V	4% + 2 V	12.7 kg/28 lb	17.7 kg/39 lb	10, 11, 28, 40	\$1900	
200 $\Omega$ /V $\pm$ 1%	500 $\Omega$ /A $\pm$ 10%	1 V/V $\pm$ 1%	0.66 V/A $\pm$ 10%	15 ms	45 ms	200 ms	40 ms	2.5–44 V	4% + 2 V	6.4 kg/14 lb	7.2 kg/16 lb	11, 28, 40	\$1000	
200 $\Omega$ /V $\pm$ 1%	200 $\Omega$ /A $\pm$ 10%	1 V/V $\pm$ 1%	200 mV/A $\pm$ 10%	275 ms	275 ms	13 s	275 ms	6–43 V	7% + 1 V	11.3 kg/25 lb	12.7 kg/28 lb	5, 11, 28	\$1450	
200 $\Omega$ /V $\pm$ 1%	1 k $\Omega$ /A $\pm$ 10%	1 V/V $\pm$ 1%	1 V/A $\pm$ 10%	50 ms	350 ms	1 s	50 ms	5–55 V	7% + 1.5 V	11 ka/24 lb	12.9 kg/28 lb	40	\$2250	
300 $\Omega$ /V $\pm$ 1%	1 k $\Omega$ /A $\pm$ 10%	1 V/V $\pm$ 1%	1 V/A $\pm$ 10%	25 ms	80 ms	2 s	175 ms	5–65 V	4% + 2 V	5.9 kg/13 lb	6.8 kg/15 lb	11, 28, 40	\$1050	
300 $\Omega$ /V $\pm$ 1%	500 $\Omega$ /A $\pm$ 10%	1 V/V $\pm$ 1%	333 mV/A $\pm$ 10%	600 ms	600 ms	5 s	200 ms	9–66 V	7% + 1 V	11.3 kg/25 lb	12.7 kg/28 lb	5, 11, 28	\$1450	
300 $\Omega$ /V $\pm$ 1%	1 k $\Omega$ /A $\pm$ 10%	1 V/V $\pm$ 1%	1.3 V/A $\pm$ 10%	25 ms	200 ms	1.5 s	200 ms	20–106 V	4% + 2 V	5.9 kg/13 lb	6.8 kg/15 lb	11, 28, 40	\$1050	

\*UP = Increasing output voltage. NL = No output load current. FL = Full rated output load current.

☎ For same-day shipment, call HP Direct at 800-538-8787

# POWER SUPPLIES

## Autorange Power Supplies

HP 6010A, 6011A, 6012B, 6015A, 6023A, and 6024A

- Complete front panel control/display
- Constant voltage/constant current operation
- Remote programming and sensing
- Autoranging output
- High efficiency, compact, and light weight
- Ten-turn voltage and current controls



HP 6024A

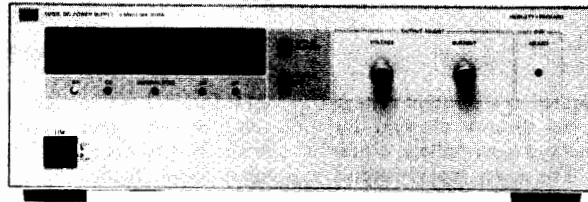

HP 6010A, 6011A, 6012B, 6015A

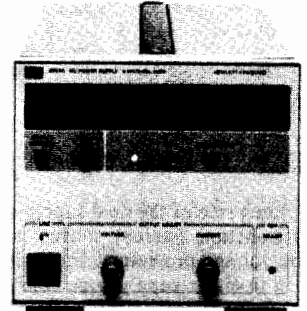

HP 6023A

### Description

#### HP Models 6010A, 6011A, 6012B, 6015A, and 6023A

This versatile family of dc power supplies provides laboratory grade performance along with many features to meet both laboratory and system needs.

Ten-turn front panel controls provide the means to precisely adjust the output voltage and current. The settings of these controls can be observed on the front panel meters by pressing the Display Settings button. This allows the current limit to be set when operating in the CV mode without shorting the output terminals and the voltage limit to be set when operating in the CC mode without opening the load leads.

Three and one-half digit front panel meters provide a convenient means for monitoring the output voltage and current. The accuracy of these meters allow them to replace external DVMs and monitor resistors in many applications that require monitoring of the power supply output.

The overvoltage protection (OVP) trip level can also be displayed on the front panel meters, allowing the trip level to be accurately adjusted without actually activating the OVP circuitry or disconnecting loads. In addition to the protection provided to the power supply and load by the OVP, these supplies also have protection against operating under excessive ac line or thermal conditions.

As autoranging power supplies, these units can operate at their maximum rated power over a wide and continuous range of voltage and current combinations. This often allows both present and future requirements to be satisfied with fewer supplies.

HP Model 6023A is stable when operating in the CC mode into inductive loads up to one henry. HP Models 6010A, 6011A, 6012B and 6015A are stable when operating in the CC mode into inductive loads up to 100 mH, and a special modification is available for these three models to assure stability with loads up to ten henries.

### System Features

The output voltage and current of these supplies can be remotely controlled with either 0-5 volt or 0-4000 ohm analog programming signals. The actual output levels can be monitored without complicated external circuitry by connecting DVMs to the buffered 0-5 volt monitor outputs. All programming and monitoring signals are referenced to the same common and are accessed through the rear panel barrier strip.

Either terminal may be grounded, or floated up to  $\pm 240$  volts from chassis ground for the HP 6011A, 6012B and 6023A, and  $\pm 550$  volts for the HP 6010A and 6015A.

If more output voltage or current is needed than a single unit can provide, auto-series or auto-parallel configurations can be used. Up to four 1000-watt units, or up to two 200-watt units can be connected in auto-parallel, and any combination can be used in auto-series providing up to 240 volts total (550 Vdc for HP 6010A and 6015A) from chassis ground including output voltage. Remote sensing can be used to maintain the CV load effect specification at the load with up to 0.5 volt drop per load lead and sense wires that are less than 0.2 ohm per lead. Operation is possible with up to 2.0 volts per lead; however, load effect specification may be degraded. For more system control and monitoring capabilities, see Option 002.\*\*

### Specifications

Ratings*		Autoranging Output*							Regulation				10% Change Transient Recovery
									Load Effect		Source Effect		
Volts	Amperes	V <sub>1</sub>	P <sub>1</sub>	V <sub>2</sub>	P <sub>2</sub>	V <sub>3</sub>	P <sub>3</sub>	HP Model	Voltage	Current	Voltage	Current	Time / Level
0-20	0-30	20V	200W	14V	242W	6.7V	200W	6023A	0.01% +2mV	0.01% +9mA	0.01% +1mV	0.01% +6mA	1ms / 50mV
0-20	0-120	20V	1000W	14V	1064W	7V	840W	6011A†	0.01% +3mV	0.01% +15mA	0.01% +2mV	0.01% +25mA	2ms / 100mV
0-60	0-10	60V	200W	40V	240W	20V	200W	6024A	0.01% +3mV	0.01% +3mA	0.01% +5mV	0.01% +5mA	1ms / 75mV
0-60	0-50	60V	1000W	40V	1200W	20V	1000W	6012B†	0.01% +5mV	0.01% +10mA	0.01% +3mV	0.01% +10mA	2ms / 100mV
0-200	0-17	200V	1000W	120V	1200W	60V	1020W	6010A†	0.01% +5mV	0.01% +10mA	0.01% +5mV	0.01% +5mA	2ms / 150mV
0-500	0-5	500V	1000W	350V	1050W	200V	1000W	6015A†	0.01% +13mV	0.03% +34mA	0.01% +13mV	0.03% +17mA	5ms / 200mV

\*See the generalized autoranging output characteristic curve.

†HP models 6010A, 6011A, 6012B & 6015A are equipped with barrier block connectors to attach user supplied cords.

\*\*Option 002 not available with HP model 6015A.

**HP Model 6024A**

As an autoranging dc power supply, the HP 6024A can provide 200 watts over a wide and continuous range of voltage and current combinations, with maximums of 60 volts and 10 amperes. This provides greater flexibility than traditional power supplies that have only one maximum power point.

Ten-turn potentiometers provide precise control of the output voltage and current. The output levels can be observed on the separate front panel voltage and current meters. Terminals are available on both the front and rear panel for load connections.

The built-in OVP is adjustable from the front panel. Other protection features include over-temperature and high ac line detection.

The HP 6024A has many system oriented features. It can be remotely programmed with 0-5 volt or 0-2500 ohm analog signals. The output current can be easily monitored without an external shunt with the proportional 0-5 volt buffered monitor output. Remote sensing can be used to eliminate the effects of voltage drops in the load leads, and either terminal may be floated up to ±240 volts from chassis ground. Several units can be combined in auto-series, auto-parallel, and auto-tracking configurations, further increasing the HP 6024A's flexibility.

For more system features, see Option 002.

**General Specifications**

**Dimensions**

**HP 6010A, 6011A, 6012B and 6015A:** 132.6 mm H x 425.5 mm W x 516.4 mm D (5.2" x 16.75" x 20.33").

**HP 6023A:** 177.0 mm H x 212.3 mm W x 443.6 mm D (6.97" x 8.36" x 17.872").

**HP 6024A:** 133.4 mm H x 212.3 mm W x 415.33 D (5.25" x 8.36" x 16.35").

**Ordering Information**

**Option Descriptions**

- **Opt 002** provides extra programming and monitoring capabilities for system use. A card inserted into the power supply is accessible through a 37-pin connector on the rear panel. It provides easy access to the control and monitor signals available on standard units, as well as these additional features:
  - OVP trip and reset
  - power supply inhibit
  - status bits indicating CV mode, CC mode, unregulated output, OVP tripped, overtemperature condition, and ac line drop-out
  - remote programming via a 0-2 mA current sink
  - bias supplies for your circuitry: +5 volts at 100 mA, +15 volts at 75 mA, and -15 volts at 75 mA.
  - buffered 0-5 volt outputs representing both the output voltage and output current. (HP 6010A, 6011A, 6012B, 6015A and 6023A provide this feature standard, but HP 6024A provides only a scaled 0-5 volt output to represent output current, not output voltage.)
  - programmable remote/local for use when programming with a current sink.

**Price**

\$345

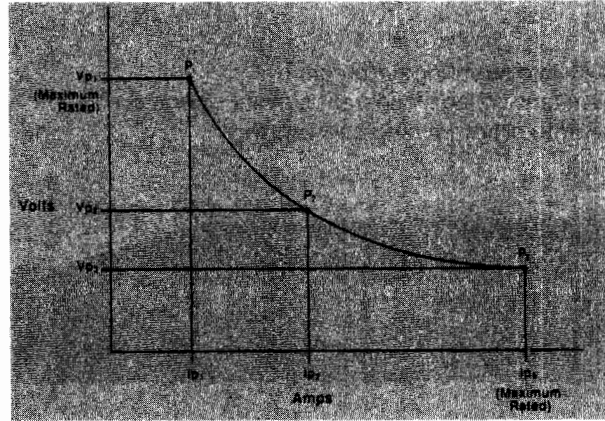

Generalized autoranging output characteristic curve

These features can all be taken advantage of with an HP 6942A, 6944A or 6954A Multiprogrammer instrument sub-system configured with an HP 69709A Power Supply Programming Card. The Multiprogrammer provides a cost-effective solution for controlling a group of power supplies, and also can provide many other digital and analog monitoring and control functions, all on the HP-IB. The voltage and current programming resolution available with this card is 1/1000th of full scale.

The features available with Option 002 can also be interfaced to your own external circuitry rather than an HP Multiprogrammer.

- Opt 100** 87-106 Vac, 48-63 Hz. HP 6024A Only! \$0  
This option is for use in Japan only. The power supply output power is 75% of the output power available with the other line voltage options. For HP 6024A only.
- Opt 220** 191 to 233 Vac, 48-63 Hz. \$0
- Opt 240** 208 to 250 Vac, 48-63 Hz. \$0
- Opt 800** Rack-mount kit for two units side by side. This applies to HP 6023A and 6024A only.
  - HP 6023A \$63
  - HP 6024A \$69
- Opt 908** Rack-mount kit for a single unit. A blank filler panel is supplied when ordered for half rack width units.
  - HP 6010A, 6011A, 6012B, 6015A \$36
  - HP 6023A \$84
  - HP 6024A \$64
- Opt 909** Rack-mount kit with handles for HP Models 6010A, 6011A, 6012B, and 6015A \$85
- Opt 910** One extra operating and service manual shipped with each power supply.
  - HP 6024A \$10
  - HP 6010A, 6011A, 6012B, 6015A, 6023A \$21

PARΔ (rms/p-p) 20Hz-20MHz		Programming Response Time						General*						Price	
		Settling Band	UP		DOWN		Light Load		AC Input Current				Weight kg (lbs)		
			Full Load	No Load	Full Load	Light Load	Time	Load	100 Vac	120 Vac	220 Vac	240 Vac	Net		Shipping
Voltage	Current														
3 mV 30 mV	15 mA —	5 mV	100 ms	100 ms	200 ms	500 ms	50 Ω	—	6.5 A	3.8 A	3.6 A	8.6 (19)	10.5 (23)	\$2025	
8 mV 50 mV	120 mA —	30 mV	300 ms	300 ms	500 ms	1.5 s	50 Ω	—	24 A	15 A	14 A	16.8 (37)	22.2 (49)	\$3125	
3 mV 30 mV	5 mA —	60 mV	200 ms	200 ms	300 ms	600 ms	Open	5.3 A	5.3 A	2.9 A	2.7 A	5.4 (12)	7.3 (16)	\$2025	
8 mV 40 mV	25 mA —	90 mV	300 ms	300 ms	2.0 s	3.0 s	100 Ω	—	24 A	15 A	14 A	15.9 (35)	21.3 (47)	\$3125	
22mV 50mV	15mA —	300 mV	300 ms	300 ms	600 ms	3.5 s	Open	—	24 A	15 A	14 A	16.3 (36)	21.7 (48)	\$3125	
50mV 160mV	50mA —	750 mV	350 ms	250 ms	600 ms	7.0 s	Open	—	24 A	15 A	14 A	16.3 (36)	21.7 (48)	\$3500	

\* An ac input option must be specified when ordering.

# POWER SUPPLIES

General Purpose: 200–2000 W Output  
HP 6259B-6274B

- Built-in overvoltage protection
- Constant voltage/constant current operation
- Remote programming and sensing

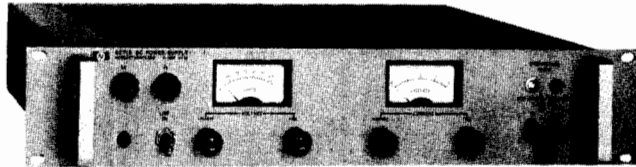

HP 6263B, 6266B

- Remote sensing
- Auto-series, -parallel, and -tracking operation
- $\leq 50 \mu\text{s}$  load transient recovery

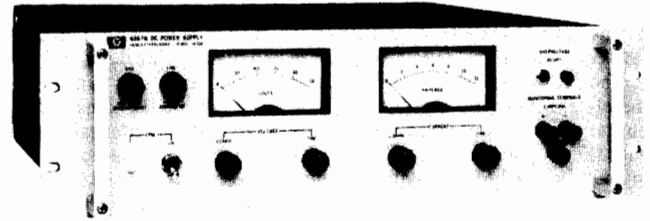

HP 6264B, 6267B

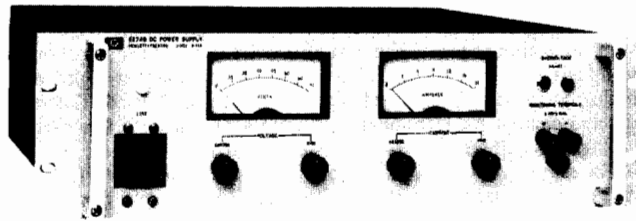

HP 6274B

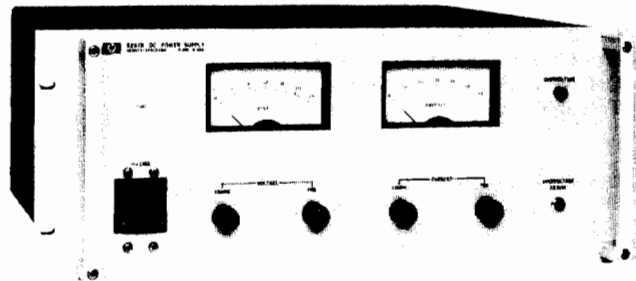

HP 6259B, 6260B, 6261B, 6268B, 6269B

## Description

### Models 6259B-6274B

This series of high-performance constant voltage/constant current supplies includes twelve models with output rating from 10 to 60 W. All models employ a transistor series-regulator/triac-preregulator circuit to achieve high efficiency, excellent regulation, low ripple and noise, and moderate programming speeds in a compact full-rack width package.

Separate coarse and fine voltage and current controls allow the voltage and current outputs to be varied from zero to the maximum rated value, crossover from constant voltage to constant current operation occurs automatically when the load current exceeds the value established by the current control settings.

Additional features include built-in overvoltage crowbar protection; remote error sensing; and auto-series, auto-parallel, and auto-tracking operation. The crowbar trip point adjustment and associated overvoltage indicator are conveniently located on the front panel.

Auto-series, auto-parallel, and auto-tracking connections should ordinarily include no more than three supplies. If a specific application requires the use of more than three supplies in any of the three connections, consult your local HP Field Engineer for additional information.

All dc output, ac input, sensing, control, and programming connections are made to rear-panel terminals. Either the positive or negative output terminal may be grounded or the supplies may be operated floating at up to 300 volts above ground. Models 6263B, 6264B, 6266B and 6267B are convection cooled. All other models in this series employ cooling fans. Models which output more than 200 watts are equipped with terminal blocks for ac input and are not shipped with line cords.

## Specifications†

RATINGS			PERFORMANCE							
DC Output		HP Model	Load Effect		Source Effect		PAR (rms/p-p)		Drift (stability)	
Volts	Amperes		Voltage	Current	Voltage	Current	Voltage	Current	Voltage	Current
0-10	0-50	6259B	0.01% + 200 $\mu\text{V}$	0.02% + 1 mA	0.01% + 200 $\mu\text{V}$	0.02% + 1 mA	500 $\mu\text{V}/5 \text{ mV}$	25 mA rms	0.03% + 2 mV	0.03% + 10 mA
0-10	0-100	6260B	0.01% + 200 $\mu\text{V}$	0.02% + 2 mA	0.01% + 200 $\mu\text{V}$	0.02% + 2 mA	500 $\mu\text{V}/5 \text{ mV}$	50 mA rms	0.03% + 2 mV	0.03% + 20 mA
0-20	0-10	6263B	0.01% + 200 $\mu\text{V}$	0.02% + 500 $\mu\text{A}$	0.01% + 200 $\mu\text{V}$	0.02% + 500 $\mu\text{A}$	200 $\mu\text{V}/10 \text{ mV}$	3 mA rms	0.03% + 500 $\mu\text{V}$	0.03% + 6 mA
0-20	0-20	6264B	0.01% + 200 $\mu\text{V}$	0.02% + 500 $\mu\text{A}$	0.01% + 200 $\mu\text{V}$	0.02% + 500 $\mu\text{A}$	200 $\mu\text{V}/10 \text{ mV}$	5 mA rms	0.03% + 500 $\mu\text{V}$	0.03% + 6 mA
0-20	0-50	6261B	0.01% + 200 $\mu\text{V}$	0.02% + 1 mA	0.01% + 200 $\mu\text{V}$	0.02% + 1 mA	500 $\mu\text{V}/5 \text{ mV}$	25 mA rms	0.03% + 2 mV	0.03% + 10 mA
0-40	0-5	6266B	0.01% + 200 $\mu\text{V}$	0.02% + 500 $\mu\text{A}$	0.01% + 200 $\mu\text{V}$	0.02% + 500 $\mu\text{A}$	200 $\mu\text{V}/10 \text{ mV}$	3 mA rms	0.03% + 500 $\mu\text{V}$	0.03% + 3 mA
0-40	0-10	6267B	0.01% + 200 $\mu\text{V}$	0.02% + 500 $\mu\text{A}$	0.01% + 200 $\mu\text{V}$	0.02% + 500 $\mu\text{A}$	200 $\mu\text{V}/10 \text{ mV}$	3 mA rms	0.03% + 2mV	0.03% + 3 mA
0-40	0-30	6268B	0.01% + 200 $\mu\text{V}$	0.02% + 2 mA	0.01% + 200 $\mu\text{V}$	0.02% + 2 mA	1 mV/5 mV	20 mA rms	0.03% + 2 mV	0.03% + 5 mA
0-40	0-50	6269B	0.01% + 200 $\mu\text{V}$	0.02% + 2 mA	0.01% + 200 $\mu\text{V}$	0.02% + 2 mA	1 mV/5 mV	25 mA rms	0.03% + 2 mV	0.03% + 10 mA
0-60	0-15	6274B	0.01% + 200 $\mu\text{V}$	0.02% + 500 $\mu\text{A}$	0.01% + 200 $\mu\text{V}$	0.02% + 500 $\mu\text{A}$	200 $\mu\text{V}/20 \text{ mV}$	5 mA rms	0.03% + 2 mV	0.03% + 5 mA

†Refer to page 476 for complete specification definitions.



**Specification—General**

**Load effect transient recovery:** time, 50  $\mu$ s; Level, 10 mV.  
**Resolution:** voltage control, less than 0.02%; current control, less than 0.15%.  
**Temperature coefficient per °C:** 0.01% of output plus 200  $\mu$ V.  
**Temperature ratings:** operating, 0 to 55°C; storage, -40 to 75°C.  
**Remote control programming:** these power supplies are capable of being programmed in constant voltage and constant current operation by using an external resistance or dc voltage with coefficients as shown in the table below.

Rear terminal wiring configurations for remote control operation are specified in the operating and service manual supplied with the power supply. For remote control programming procedures and timing considerations, contact your local HP field engineer.

**Power:** input voltage tolerance is  $\pm$ 10%, 57-63 Hz. For other input voltage and frequency options available, see option listing in the specifications table below. Standard input voltage, maximum input current, and maximum power are:

- HP 6259B, 230 V ac, 6 A, 850 W;
- HP 6260B, 230 V ac, 12 A, 1600 W;
- HP 6263B, 115 V ac, 4.5 A, 350 W;
- HP 6266B, 115 V ac, 4 A, 325 W;
- HP 6268B, 230 V ac, 12 A, 1600 W;
- HP 6261B, 230 V ac, 12 A 1500 W;
- HP 6264B, 115 V ac, 8 A, 600 W;
- HP 6267B, 115 V ac, 8 A, 550 W;
- HP 6269B, 230 V ac, 18 A, 2500 W;
- HP 6274B, 115 V ac, 15 A, 1200 W.

**AC line connections:** three wire, five foot ac power cord included—HP 6263B and 6266B.

Three-terminal barrier strip provided on power supply for ac power connections—HP 6259B, 6260B, 6261B, 6264B, 6267B, 6268B, 6269B and 6274B.

**Size**

- HP 6263B, 6266B: 83.7 H x 483 W x 479.4 mm D (3.296" x 19" x 18.875").
- HP 6264B, 6267B, 6274B: 127 H x 483 W x 479.4 mm D (5.00" x 19" x 18.875").
- HP 6259B, 6260B, 6261B, 6268B, 6269B: 173 H x 483 W x 479.4 mm D; (6.812" x 19" x 18.875").

**Option Descriptions**

- 005:** 50 Hz ac input: optimizes power supplies that require adjustment/modification for 50 Hz operation. \$0
- 010:** chassis slides. For access to rack mounted power supplies: HP 6263B, 6264B, 6266B, 6267B + \$91.00
- HP 6274B, 6259B, 6260B, 6261B, 6268B, 6269B + \$168.00
- 016:** Model 6260B only. 115 Vac  $\pm$  10% single phase input. Consists of replacing power transformer and circuit breaker, and reconnecting bias transformer, RFI choke and fans. + \$126.00
- 022:** voltage and current programming adjust. Allows the V and I programming coefficients and zero output to be conveniently adjusted to 0.1% accuracy via access holes in the rear panel. Consists of four potentiometers and resistors located inside the rear panel. + \$64.00
- 026:** 115 Vac  $\pm$  10%, single phase input. Consists of replacing the input circuit breaker and reconnecting the power transformer, bias transformer, RFI choke, and fans. Models 6259B, 6261B and 6268B only. \$0
- 027:** 208 Vac,  $\pm$  10%, single phase input. Consists of reconnecting power transformer taps, and other components where necessary. \$0
- 028:** 230 Vac  $\pm$  10%, single phase input. Consists of reconnecting power transformer taps, and other components where necessary. \$0
- 040:** Multiprogrammer interface. Prepares standard HP power supplies for resistance programming by the HP 6942A, 6944A or 6954A Multiprogrammers. This option includes Option 022, special calibration, and protection check-out procedures (where required). + \$80.00
- 910:** one additional operating and service manual shipped with each power supply. HP 6259B-6274B + \$7.88

**Specifications, Continued**

REMOTE CONTROL FEATURES								GENERAL					
Resistance Coeff.		Voltage Coeff.		Speed Up*		Speed Down*		Overvoltage		Weight		Options	Price
Voltage	Current	Voltage	Current	NL	FL	NL	FL	Range	Margin	Net	Shipping		
200 $\Omega$ /V $\pm$ 1%	4 $\Omega$ /A $\pm$ 10%	1 V/V $\pm$ 1%	10 mV/A $\pm$ 10%	70 ms	70 ms	200 ms	100 ms	2-12 V	5% + 2V	31.3 kg/69 lb	35.3 kg/78 lb	5, 10, 22, 26, 27, 40	\$2700
200 $\Omega$ /V $\pm$ 1%	2 $\Omega$ /A $\pm$ 10%	1 V/V $\pm$ 1%	5 mV/A $\pm$ 10%	70 ms	70 ms	200 ms	75 ms	2-12 V	5% + 2 V	43.9 kg/97 lb	48 kg/106 lb	5, 10, 16, 22, 27, 40	\$3100
200 $\Omega$ /V $\pm$ 1%	100 $\Omega$ /A $\pm$ 10%	1 V/V $\pm$ 1%	50 mV/A $\pm$ 10%	150 ms	150 ms	7 s	350 ms	2-23 V	5% + 1 V	15.4 kg/34 lb	18.6 kg/41 lb	5, 10, 22, 27, 28, 40	\$1950
200 $\Omega$ /V $\pm$ 1%	10 $\Omega$ /A $\pm$ 10%	1 V/V $\pm$ 1%	25 mV/A $\pm$ 10%	140 ms	140 ms	10 s	150 ms	2.5-23V	5% + 1 V	21.3 kg/47 lb	24.5 kg/54 lb	5, 10, 22, 27, 28, 40	\$2000
200 $\Omega$ /V $\pm$ 1%	4 $\Omega$ /A $\pm$ 10%	1 V/V $\pm$ 1%	10 mV/A $\pm$ 10%	150 ms	150 ms	250 ms	250 ms	2-23 V	5% + 2 V	35.3 kg/78 lb	39.4 kg/87 lb	5, 10, 22, 26, 27, 40	\$2900
200 $\Omega$ /V $\pm$ 1%	200 $\Omega$ /A $\pm$ 10%	1 V/V $\pm$ 1%	100 mV/A $\pm$ 10%	275 ms	275 ms	13 s	1.5 s	2.5-45 V	5% + 1 V	15.4 kg/34 lb	18.6 kg/41 lb	5, 10, 22, 27, 28, 40	\$1950
200 $\Omega$ /V $\pm$ 1%	100 $\Omega$ /A $\pm$ 10%	1 V/V $\pm$ 1%	50 mV/A $\pm$ 10%	275 ms	275 ms	13 s	750 ms	2.5-45 V	5% + 1 V	17.7 kg/39 lb	20.8 kg/46 lb	5, 10, 22, 27, 28, 40	\$2000
200 $\Omega$ /V $\pm$ 1%	6 $\Omega$ /A $\pm$ 10%	1 V/V $\pm$ 1%	16.7 mV/A $\pm$ 10%	300 ms	300 ms	1 s	650 ms	4-45 V	5% + 1 V	34.4 kg/76 lb	38.1 kg/84 lb	5, 10, 22, 26, 27, 4 0	\$2800
200 $\Omega$ /V $\pm$ 1%	4 $\Omega$ /A $\pm$ 10%	1 V/V $\pm$ 1%	10 mV/A $\pm$ 10%	350 ms	350 ms	1 s	600 ms	4-45 V	5% + 1 V	40.3 kg/89 lb	44 kg/98 lb	5, 10, 22, 27, 40	\$2875
300 $\Omega$ /V $\pm$ 1%	67 $\Omega$ /A $\pm$ 10%	1 V/V $\pm$ 1%	33.3 mV/A $\pm$ 10%	600 ms	600 ms	40 s	800 ms	6-66 V	5% + 1 V	21.7 kg/48 lb	24.5 kg/54 lb	5, 10, 22, 27, 28, 40	\$2200

\*Up = increasing output voltage. NL = No output load current. FL = Full rated output load current

# POWER SUPPLIES

## General Purpose: 300—11,000 W Output

### HP 6434B—6483C

- Outstanding value—low cost/watt
- Up to 75% efficiency at full output
- Constant voltage/constant current operation

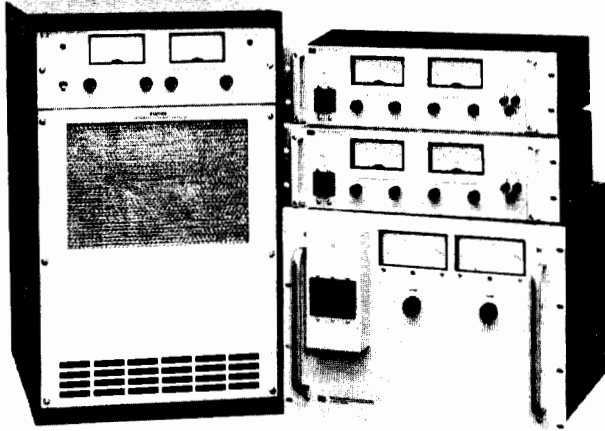

HP 6434B—6483C

### Description

This series of SCR-regulated power supplies is designed for medium to high-power applications requiring a fixed or variable dc source with moderate regulation and ripple. For supplies with better regulation, faster response time, and lower ripple, see models HP 6259B—6274B on page 496.

### Operating Features

All supplies in this series are of the constant voltage/constant current type. Large easy-to-read panel meters continuously monitor output voltage current.

Input and output power, remote sensing, remote programming, and auto-series, -parallel, and -tracking connections are made to bus bars and terminal blocks on the rear panel.

### Protective Features

In addition to the overload protection inherent in constant voltage/constant current operation, there are many other built-in protective features included in these supplies. The features vary within the three model classifications as follows:

**HP 6434B—6448B:** (1) Reverse voltage protection. (2) Fused ac input.

**HP 6453A, 6456B, 6459A:** (1) AC line loss protection circuit monitors 3-phase input and cuts off SCR's and opens output bus if a phase drops out; operation resumes when ac input returns to normal. (2) 3-phase input circuit breaker. (3) Optional internal crowbar (Option 006) protects load from overvoltage condition.

**HP 6464C—6483C:** (1) High-temperature protection thermostat opens input to power transformer and lights front panel indicator if supply overheats. (2) Prolonged overload protection circuit is activated and lights front panel indicator if output current exceeds approximately 115% of maximum rating. (3) Optional internal crowbar (except on HP 6464C) protects load from overvoltage condition. (4) Turn-on circuit limits peak line current during start-up into low impedance loads. (5) Phase-balance circuit permits operation with line-to-line input voltage imbalance up to 8%. (6) Overcurrent and over-voltage circuits of master slave supplies used in auto-series, -parallel, or -tracking operation can be interlocked.

### Auto-Series, -Parallel, -Tracking Operation

Supplies may be connected in auto-series, or auto-tracking (except HP 6448B and 6483C, which cannot be connected in auto-series).

Up to three lower-power models (HP 6434B—6448B) may be connected in any of the above configurations. Higher-power model (HP 6453A/6483C) interconnection should ordinarily include no more than two supplies.

### Remote Programming

The voltage and current outputs of the supplies can be programmed by a remote resistance, or for most models, a remote voltage source. Programming speeds and coefficients are detailed in the specifications table.

### AC Power Requirements

The ac power requirements vary with the three model classifications (see option listings). When powered from a 50 Hz source (possible with option 005), the rms ripple and transient response specifications increase by 50%. The p-p ripple specification is unchanged by line frequency.

### Line Cords

Line cords are not supplied with models 6434B, 6448B and 6453A-6483C.

### Specifications†

RATINGS			PERFORMANCE						
DC Output		HP Model	Load Effect		Source Effect		PARD Δ rms/p-p	Temperature Coefficient	Drift
Volts‡	Ampere‡		Voltage	Current	Voltage	Current			
0-8	0-1000	HP 6464C	0.05% + 5 mV	0.1% + 1 A	0.05% + 5 mV	0.1% + 1 A	80 mV/1 V	0.03% + 100 μV	0.03% + 1 mV
0-15	0-200	HP 6453A	0.2% + 10 mV††	1% or 2 A††	0.2% + 10 mV††	1% or 2 A††	150 mV rms	0.05% + 2 mV	0.25% + 10 mV
0-16 or 18	0-600 or 500*	HP 6466C	0.05% + 5 mV	0.1% + 0.6 A	0.05% + 5 mV	0.1% + 0.6 A	180 mV/1 V	0.03% + 200 μV	0.2% + 1 mV
0-36	0-100	HP 6456B	0.2% + 10 mV††	1% or 1 A††	0.2% + 10 mV††	1% or 1 A††	180 mV rms	0.05% + 2 mV	0.25% + 10 mV
0-36	0-300	HP 6469C	0.05% + 5 mV	0.1% + 0.3 A	0.05% + 5 mV	0.1% + 0.3 A	180 mV/1 V	0.03% + 400 μV	0.15% + 1 mV
0-40	0-25	HP 6434B	40 mV	200 mA	18 mV	200 mA	40 mV/500 mV	0.03% + 5 mV	0.1% + 20 mV
0-64	0-50	HP 6459A	0.2% + 10 mV††	1% or 0.5 A††	0.2% + 10 mV††	1% or 0.5 A††	160 mV rms	0.05% + 2 mV	0.25% + 10 mV
0-64	0-150	HP 6472C	0.05% + 100 mV	0.1% + 0.15 A	0.05% + 100 mV	0.1% + 0.15 A	160 mV/2 V	0.03% + 4 mV	0.15% + 16 mV
0-110	0-100	HP 6475C	0.05% + 100 mV	0.1% + 0.1 A	0.05% + 100 mV	0.1% + 0.1 A	200 mV/2 V	0.03% + 5 mV	0.15% + 20 mV
0-220	0-50	HP 6477C	0.05% + 100 mV	0.1% + 50 mA	0.05% + 100 mV	0.1% + 50 mA	330 mV/2 V	0.03% + 8 mV	0.15% + 35 mV
0-300	0-35	HP 6479C	0.05% + 100 mV	0.1% + 35 mA	0.05% + 100 mV	0.1% + 35 mA	330 mV/3 V	0.03% + 11 mV	0.15% + 45 mV
0-440, 500 or 600	0-25, 20, 15*	HP 6483C	0.05% + 100 mV	0.1% + 35 mA	0.5% + 100 mV	0.1% + 35 mA	600 mV/5 V	0.03% + 20 mV	0.15% + 80 mV
1-600	5 mA-1.5 A	HP 6448B	1 V	40 mA	600 mV	15 mA	600 mV/2 V	0.03% + 100 mV	0.1% + 300 mV

†Refer to page 476 for complete specification definitions.

††Specified for combined line and load regulation.

Δ For operation with a 50 Hz input (possible only with Option 005), the rms ripple and transient response specifications are increased by 50%.

\* The output current rating is given in the same order corresponding with the voltage rating.

§ Under light loading conditions, power supply may not meet all published specifications. The graph on the next page defines the permissible operating regions for CV and CC modes of operation.

For operation with a 50 Hz input (possible only with Option 005), output current is linearly derated from 100% at 40°C to 80% at 50°C.

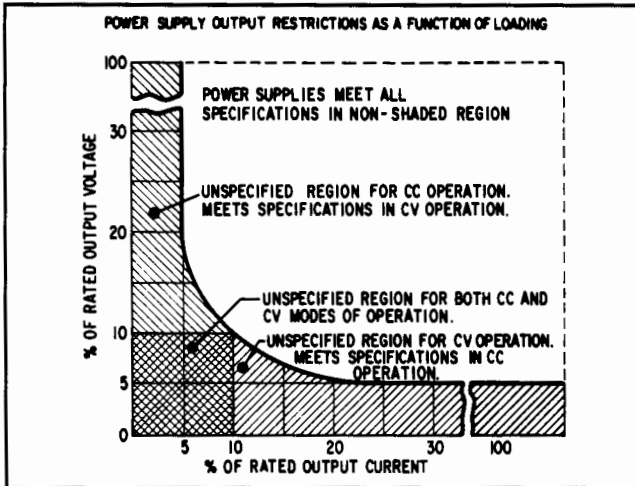

**Site Evaluation**

Higher power units (HP Models 6464C-6483C) most likely will require installation of a dedicated electrical branch service. It is suggested that a site evaluation be conducted by a qualified electrician or engineer prior to ordering. At that time, the electrician can help determine the correct line voltage option to order.

**Size**

**Models 6434B, & 6448B:** 133 H x 483 W x 432 mm D (5.25" x 19" x 17").  
**Models 6453A, 6456B, & 6459A:** 356 H x 483 W x 500 mm D (14" x 19" x 19.7").  
**Models 6484C, 6486C, 6489C, 6472C, 6475C, 6477C, 6479C, & 6483C:** 705 H x 483 W x 715 mm D (27.75" x 19" x 28.12").

**Option Descriptions**

**HP 6434B-6448B**

**Std:** 115 V ac, ± 10%, single phase, 57-63 Hz  
**005:** realignment for 50 Hz operation  
**010:** chassis slides  
**027:** 208 V ac, ± 10%, single phase, 57-63 Hz  
**028:** 230 V ac, ± 10%, single phase, 57-63 Hz  
**910:** one extra operating and service manual shipped with each power supply

**Price**  
 \$0  
 \$0  
 + \$168  
 \$0  
 \$0  
 + \$10

**HP 6453A, 6456B, 6459A**

An ac input option must be specified when ordering. 3 phase voltages are phase to phase.

ac input connections are by means of a 4-conductor connector at rear of unit. Low voltage (208 V, 230 V) models are furnished with an Arrow Hart and Hageman plug (HP 1251-6896). High voltage (380 V, 400 V, 460 V) models are furnished with an Arrow Hart and Hageman plug (HP 1251-6897).  
**001:** 208 V ac, ± 10%, 3-phase, 15.5 A/phase, 57-63 Hz \$0  
**002:** 230 V ac, ± 10%, 3-phase, 14 A/phase, 57-63 Hz \$0  
**003:** 460 V ac, ± 10%, 3-phase, 7 A/phase, 57-63 Hz + \$105  
**005:** realignment for 50 Hz operation \$0  
**006:** overvoltage protection crowbar for HP 6453A, 6459A + \$520  
 HP 6456B + \$685  
**010:** chassis slides + \$270  
**031:** 380 V ac, ± 10%, 3-phase, 8.5 A/phase, 57-63 Hz + \$158  
**032:** 400 V ac, ± 10%, 3-phase- 8.0 A/phase, 57-63 Hz +\$158  
**910:** one extra operating and service manual shipped with each power supply. +\$10

**HP 6464C-6483C**

An ac input option must be specified when ordering. 3 phase voltages are phase-to-phase. AC input connections are by means of enclosed 4-wire terminal block

**Opt 001:** 208 V ac, ± 10%, 3-phase, 55 A/phase, 57-63 Hz \$0  
**Opt 002:** 230 V ac, ± 10%, 3-phase, 50 A/phase, 57-63 Hz \$0  
**Opt 003:** 460 V ac, ± 10%, 3-phase, 25 A/phase, 57-63 Hz + \$270  
**Opt 005:** realignment for 50 Hz operation \$0  
**Opt 006:** internal overvoltage protection crowbar for HP 6477C, 6479C, 6483C + \$420  
 HP 6466C + \$605  
 HP 6469C + \$540  
 HP 6472C, 6475C + \$490  
**Opt 023:** rack mounting attachments for standard 19" rack + \$137  
**Opt 031:** 380 V ac, ± 10%, 3-phase, 30 A/phase, 57-63 Hz + \$270  
**Opt 032:** 400 V ac, ± 10%, 3-phase, 28.5 A/phase, 57-63 Hz + \$270  
**Opt 040:** prepares power supply to be programmed with resistance by an HP 6942A, 6944A or 6954A. + \$105  
**Opt 910:** one extra operating and service manual shipped with each power supply. + \$15

**Accessory**

**HP 14545B:** casters for HP 6464C-6483C—set of four \$103

**Specifications, continued from page 498**

REMOTE CONTROL										GENERAL				
Resolution		Load Transient Recovery $\Delta$	Resistance Coefficient		Voltage Coefficient $\dagger$		Up		Down		Net Weight		Options	Price
V	C		Voltage	Current	Voltage	Current	NL	FL	NL	FL	Kg	lb		
8 mV	1 A	100 ms, 500 mV	200 $\Omega$ /V $\pm$ 2%	1 $\Omega$ /A $\pm$ 2%	1 V/V $\pm$ 1%	6.2 mV/A $\pm$ 7%	1.6 s	0.6 s	6 s	0.1 s	235	518	1, 2, 3, 5, 23, 31, 32, 40	\$15000
65 mV	1 A	50 ms, 150 mV	200 $\Omega$ /V $\pm$ 2%	1 $\Omega$ /A	0.4 V/V	30 mV/A	1 s	0.5 s	20 s	0.2 s	108	238	1, 2, 3, 5, 6, 10, 31, 32	\$7000
18 mV	0.5 A	100 ms, 500 mV	200 $\Omega$ /V $\pm$ 2%	1.66 $\Omega$ /A $\pm$ 2%	1 V/V $\pm$ 1%	10.3 mV/A $\pm$ 7%	1.6 s	0.6 s	15 s	0.2 s	226	500	1, 2, 3, 5, 6, 23, 31, 32, 40	\$14500
90 mV	0.5 A	50 ms, 300 mV	200 $\Omega$ /V $\pm$ 2%	2 $\Omega$ /A	166 mV/V	60 mV/A	1 s	0.5 s	60 s	0.5 s	108	238	1, 2, 3, 5, 6, 10, 31, 32	\$7000
36 mV	0.3 A	100 ms, 500 mV	200 $\Omega$ /V $\pm$ 2%	3.33 $\Omega$ /A $\pm$ 2%	1 V/V	20.6 mV/A $\pm$ 7%	1.6 s	3 s	20 s	0.5 s	226	500	1, 2, 3, 5, 6, 23, 31, 32, 40	\$14000
10 mV	12.5 mA	200 ms, 200 mV	200 $\Omega$ /V $\pm$ 2%	12 $\Omega$ /A	1 V/V	**	0.3 s	1.2 s	75 s	1.2 s	30.4	67	5, 10, 27, 28	\$2600
100 mV	0.25 A	50 ms, 600 mV	300 $\Omega$ /V $\pm$ 2%	4 $\Omega$ /A	94 mV/V	120 mV/A	1 s	0.5 s	45 s	0.7 s	108	238	1, 2, 3, 5, 6, 10, 31, 32	\$7000
64 mV	0.15 mA	100 ms, 750 mV	300 $\Omega$ /V $\pm$ 2%	6.7 $\Omega$ /A $\pm$ 2%	1 V/V $\pm$ 3%	41.2 mV/A $\pm$ 7%	1.4 s	2.5 s	55 s	0.7 s	226	500	1, 2, 3, 5, 6, 23, 31, 32, 40	\$14000
22 mV	0.1 A	100 ms, 1 V	300 $\Omega$ /V $\pm$ 2%	10 $\Omega$ /A $\pm$ 2%	1 V/V $\pm$ 3%	62 mV/A $\pm$ 7%	1.5 s	2 s	80 s	0.7 s	226	500	1, 2, 3, 5, 6, 23, 31, 32	\$14000
44 mV	50 mA	100 ms, 2 V	300 $\Omega$ /V $\pm$ 2%	20 $\Omega$ /V $\pm$ 2%	1 V/V $\pm$ 3%	124 mV/A $\pm$ 7%	1.5 s	2 s	95 s	1 s	226	500	1, 2, 3, 5, 6, 23, 31, 32	\$14000
60 mV	35 mA	100 ms, 3 V	300 $\Omega$ /V $\pm$ 2%	28.6 $\Omega$ /A $\pm$ 2%	1 V/V $\pm$ 3%	177 mV/A $\pm$ 7%	1.5 s	2 s	75 s	1.6 s	226	500	1, 2, 3, 5, 6, 23, 31, 32	\$14000
60 mV	25 mA	100 ms, 5 V	300 $\Omega$ /V $\pm$ 2%	40 $\Omega$ /A $\pm$ 2%	1 V/V $\pm$ 3%	0.25 V/A $\pm$ 7%	1.5 s	2 s	120 s	2 s	226	500	1, 2, 3, 5, 6, 23, 31, 32	\$14500
60 mV	0.75 mA	200 ms, 3 V	300 $\Omega$ /V $\pm$ 2%	600 $\Omega$ /A	1 V/V	**	0.2 s	1 s	45 s	2 s	27.6	61	5, 10, 27, 28	\$2600

$\Delta$ For operation with a 50 Hz input (possible only with Option 005), the rms ripple and transient response specifications are increased by 50%.

\*\*This feature is not available.

\*An ac input option must be specified when ordering these 3-phase models.

$\dagger$ Special Option J30 must be ordered with models 6434B-6448B and 6466C-6483C to be programmed with an HP 59501B Power Supply Programmer. Contact your local HP Field Engineer for ordering instructions.

# POWER SUPPLIES

Laboratory: Single & Multiple Output, 10W to 38W

HP 6200B-6218C and 6234A-6237B

- HP 6212C-6218C . . . 10 watts output
- Compact, impact-resistant stackable case
- Short-circuit proof
- HP 6200B-6209B . . . 30 watts output
- Auto series, parallel, and tracking
- Remote sensing



Single Output: HP 6212C-6218C

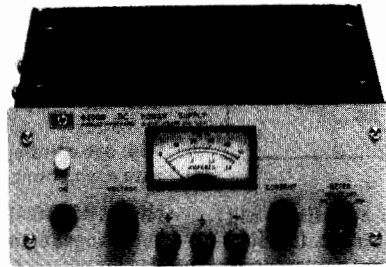

Single Output: HP 6200B-6209B

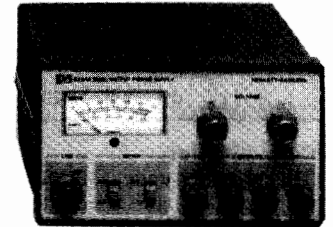

Dual Output: HP 6234A

## Description—Single Output Models

### Models 6212C-6218C

These popular low-cost CV/CC bench supplies are designed for general laboratory use and are equipped with front-panel mounted voltage and current controls, a combination volt/ammeter, and output binding posts. Output voltage and current are continuously variable, via multiple-turn controls from 0 to 15% above the maximum rated output. A switch selects either output voltage or current for display on the panel meter.

Load connections are made via three binding posts. Either the + or the - post may be grounded through an adjacent GND terminal or the supply may be operated floating at up to 300 volts above ground.

The supplies can also be operated as constant current sources with 500  $\mu$ A load regulation. All of these models can be connected in series or parallel.

The molded, impact-resistant case includes an interlocking feature for stacking several units vertically, thus minimizing bench space required for multiple supplies. Alternatively, up to three units can be mounted side by side in a 19" rack using Rack Mounting Kit HP 14521B. These supplies measure 86 H x 133 W x 368 mm D (3.40" x 5.25" x 8") and weigh 2 kg (4.4 lb).

### HP 6200B-6209B

This series of low-cost bench supplies includes three models covering an output voltage range from 0–20 V to 0–320 V. All models are equipped with ten-turn voltage and current controls, (except the HP 6206B, which does not have a current control), volt/ampere meter, meter function/range switch, and front and rear output terminals. In addition, on the dual-range models (HP 6200B and 6206B), an output range switch permits the selection of either a high or a low output voltage range.

The constant voltage/current limiting supply, HP 6206B, is short-circuit protected by a fixed current limiting circuit which is activated at approximately 110% of rated load current. The current-limit point can be reduced by changing the value of a single internal resistor. For the constant voltage/constant current supplies, ten-turn current controls allow the current-limit point to be set to any value within the current rating. Using these controls the CV/CC supplies can also be operated as constant-current sources.

Units may be bench operated or rack mounted individually or in pairs using accessory rack mounting hardware.

All models in this group of supplies measure 89 H x 216 W x 317 mm D (3.50" x 8.50" x 12.50") and weigh 4.5 kg (10 lb).

## Description—Dual Output Models

### HP 6234A

The HP 6234A is a low-cost, dual-output bench power supply with two independently adjustable and isolated power sources in one compact unit. Both of the dc power sources are of the constant voltage/current limit type with each output voltage being adjustable continuously over a 0 to 25 V range. The maximum current available per output is 0.2 A and is limited automatically to prevent overload.

The HP 6234A offers considerable flexibility to the user with output voltages that can be arranged to provide identical or different voltages in any polarity combination with respect to 0 or other common positive or negative voltage points. The outputs can also be connected in series to provide up to 50 V at 0.2 A. Both sources are fully isolated to permit either of the output terminals to be grounded.

With pushbutton switches, users can select either voltage or current for each output to be monitored on the unit's meter. Other features include two multiple-turn controls for precise voltage setting, regulation to 0.01%, and ripple and noise of less than 200 microvolts rms.

With dimensions of only 93 mm high, 157 mm wide and 210 mm deep (3.64" x 6.17" x 8.25"), the HP 6234A supply takes up a minimum amount of bench space. Its weight is 2.3 kg (5 lb). The unit can be powered from a 115 V or an optional 230 V, 47-63 Hz ac input, (Option 028).

### HP 6205C

This low-cost bench supply is equipped with ten-turn output voltage controls, volt/ampere meter, meter function/range switch, and front and rear output terminals. In addition, an output range switch permits the selection of either a high or a low output voltage range.

The HP 6205C combines the versatility of a dual power supply with the flexibility of auto-parallel and auto-series operation to extend the output ratings of this supply to 20 V/1.2 A, 40 V/0.6 A, and 80 V/0.3 A. In addition, using the supply's auto-tracking capability, opposite

- Dual output to 24 watts
- Short-circuit proof
- Independent voltage controls

- Triple output to 38 watts
- Short circuit proof
- Tracking  $\pm 20$  volt outputs

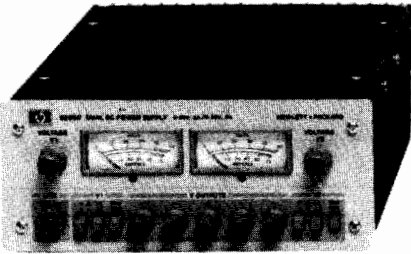

Dual Output: HP 6205C

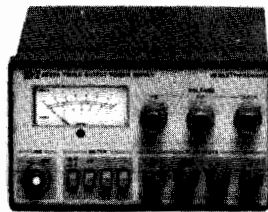

Triple Output: HP 6235A

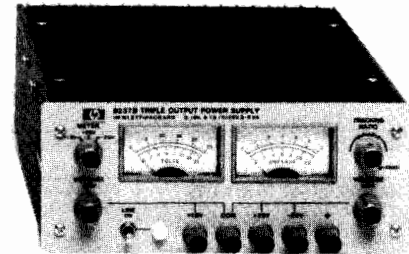

Triple Output: HP 6236B, 6237B

polarity voltages ( $\pm 20$  V,  $\pm 40$  V) can conveniently be obtained from this one supply.

This constant voltage/current limiting supply is short-circuit protected by a fixed current limiting circuit which is activated at approximately 110% of rated load current. The current-limit point can be reduced by changing the value of a single internal resistor. Units may be bench operated or rack mounted individually or in pairs using accessory rack mounting hardware.

## Description—Triple Output Models

### HP 6235A

This compact, low-cost, three-in-one power supply is a handy addition to the lab bench where single or multiple voltages are needed for designing and testing breadboards and prototypes. The HP 6235A delivers three adjustable dc output voltages: 0 to +6 V at 1 A, 0 to +18 V at 0.2 A, and 0 to -18 V at 0.2 A. A single 0 to 36 volt output at 0.2 A can also be obtained by connecting across the +18 V and -18 V terminals.

The controls, meter, and binding posts are conveniently arranged on the front panel. One voltage control simultaneously adjusts the +18 V and -18 V outputs, which track one another and can be used to power operational amplifiers and other circuits requiring balanced positive and negative voltages. The supply's dual outputs have added versatility with an adjustable tracking ratio control (TRACK) that can set the negative output to a lower voltage than the positive output. Once the tracking ratio control has established a voltage ratio between the positive and negative outputs, the ratio remains constant as the +18 V voltage control is adjusted. A third control sets the 0 to +6 V output voltage.

The supply is a constant voltage/current limit type with each output voltage continuously adjustable over its range, while the maximum current available is automatically limited to prevent overloading. The power supply's outputs share a common terminal and are isolated from chassis ground so that any output terminal can be grounded if desired. Each output voltage or current can be quickly selected and monitored with the push-button meter switches.

Model 6235A measures 89 H x 157 W x 210 mm D (3.5" x 6.17" x 8.25") and weighs 2.3 kg (5 lb).

### HP 6236B and 6237B

Microprocessors, digital and linear integrated circuits, and displays used in lab development frequently require triple output power supplies for operating prototypes. The HP 6236B and 6237B are valued additions to the design bench due to their multiple output voltages, small size, ease of operation and application-related performance.

These compact constant voltage/current limiting supplies combine 0 to  $\pm 20$  V tracking outputs rated at 0.5 A with a single output rated at 0 to +6 volts at up to 2.5 A in the HP 6236B, and 0 to +18 volts at 1 A in the HP 6237B.

Controls, meters, and binding posts are logically arranged on a neatly laid out front panel. One voltage control simultaneously adjusts the 20 V and -20 V outputs, which track within 1% to power operational amplifiers and circuits requiring balanced voltages. A tracking ratio control can disable the 1:1 tracking feature and set the negative output to a lower voltage than that of the positive output. Once the tracking ratio control has established a voltage ratio between the positive and negative outputs, the ratio remains constant as the  $\pm 20$  V voltage control varies both outputs. Another voltage control sets the 0 to +6 V (HP 6236B) or 0 to +18 V (HP 6237B) output.

All outputs are protected against overload and short-circuit damage by fixed current limiting circuits. For any overload condition, the +20 V and -20 V outputs in both models are limited to 0.55 A and the +18 V output in the HP 6237B is limited to 1.1 A. The overload protection circuit for the +6 V output in the HP 6236B has a current foldback characteristic that reduces the maximum available current from about 2.75 A at a 6 V terminal voltage to 1 A at zero volts (or short circuited). This foldback limiting characteristic maximizes the available current in the important 5 to 6-volt range while minimizing dissipation during overloads.

Another protective feature safeguards sensitive load circuitry by preventing an output voltage overshoot when the supply is turned on or off.

Separate dual-range panel meters allow both the voltage and current of any output to be monitored simultaneously. A three-position switch selects the output which the meters will monitor.

Both models measure only 89 H x 216 W x 319 mm D (3.5" x 8.5" x 12.5") and weigh 4.3 kg (9.5 lb).

# POWER SUPPLIES

## Specifications

RATINGS		PERFORMANCE							GENERAL	
dc output		HP Model	Load Effect	Source Effect	PAR rms/p-p	Control Mode and Resolution	Remote Control Coefficients	Power 115 V ac ± 10%	Options	Price
Volts	Amps									
<b>SINGLE OUTPUT—10 WATTS</b>										
0-10	0-1	HP 6214C	4 mV	4 mV	200 $\mu$ V/1 mV	CV/CC 5mV/75 $\mu$ A	**	48-440 Hz 0.3 A, 28 W	28	\$380
0-25	0-0.4	HP 6216C	4 mV	4 mV	200 $\mu$ V/1 mV	CV/CC 5mV/20 $\mu$ A	**	48-440 Hz 0.3 A, 28 W	28	\$380
0-50	0-0.2	HP 6218C	4 mV	4 mV	200 $\mu$ V/1 mV	CV/CC 10mV/10 $\mu$ A	**	48-440 Hz 0.3 A, 28 W	28	\$380
0-100	0-0.1	HP 6212C	8 mV	4 mV	200 $\mu$ V/1 mV	CV/CC 20mV/10 $\mu$ A	**	48-440 Hz 0.3 A, 28 W	28	\$450
<b>SINGLE OUTPUT—UP TO 30 WATTS</b>										
Dual range 0-20 or 0-40	0-1.5 0-0.75	HP 6200B	0.01% + 4 mV	0.01% + 4 mV	200 $\mu$ V/1 mV	CV/CC 10 mV/2 mA	2000/V ± 1% 0.5 k $\Omega$ /A ± 10% or 1 k $\Omega$ /A ± 10%	48-440 Hz 0.9 A, 70 W	11, 28	\$1050
Dual range 0-30 or 0-60	0-1 0-0.5	HP 6206B	0.01% + 4 mV	0.01% + 4 mV	200 $\mu$ V/1 mV	CV/CL 10 mV/*	3000/V ± 1%	48-440 Hz 1 A, 66 W	11, 28	\$1050
0-320	0-0.1	HP 6209B	0.02% + 2 mV	0.02% + 2 mV	1 mV/40 mV	CV/CC 40 mV/200 $\mu$ A	3000/V ± 1% 150 k $\Omega$ /A ± 10%	48-63 Hz 1 A, 60 W	28	\$1150
<b>DUAL OUTPUT—10 WATTS</b>										
Dual output 0-25 and 0-25	0.2 0.2	HP 6234A	0.01% + 1 mV	0.01% + 1 mV	200 $\mu$ V/1 mV	CV/CL	**	104-127 Vac 47-63 Hz 0.26A, 35 W	28	\$620
<b>DUAL OUTPUT—24 WATTS</b>										
Two dual ranges 0-20/0-40 and 0-20/0-40	0-0.6/0.3 0-0.6/0.3	HP 6205C	0.01% + 4 mV	0.01% + 4 mV	200 $\mu$ V/1 mV	CV/CL 10 mV/*	2000/V ± 1%	48-440 Hz 0.5 A, 50 W	11, 28 40	\$1050
<b>TRIPLE OUTPUT—13 WATTS</b>										
Triple output 0 to 6 and 0 to 18 and 0 to -18	0-1 0-0.2 0-0.2	HP 6235A	8 mV 10 mV 10 mV	8 mV 15 mV 15 mV	1 mV/5 mV 1 mV/5 mV 1 mV/5 mV	CV/CL	** ** **	47-63 Hz 0.26 A, 35 W	28	\$675
<b>TRIPLE OUTPUT—35 WATTS*</b>										
Triple output 0 to +6 and 0 to +20 and 0 to -20	2.5 0.5 0.5	HP 6236B	0.01% + 2 mV	0.01% + 2 mV	350 $\mu$ V/1.5 mV	CV/CL 70 mV/*	**	104-127 Vac 47-63 Hz 1.2 A, 112 W	100 220 240	\$900
<b>TRIPLE OUTPUT—38 WATTS*</b>										
Triple Output 0 to +18 and 0 to +20 and 0 to -20	1 0.5 0.5	HP 6237B	0.01% + 2 mV	0.01% + 2 mV	350 $\mu$ V/1.5 mV	CV/CL 70 mV/*	**	104-127 Vac 47-63 Hz 1.2 A, 112 W	100 220 240	\$900

\*fixed current limit

\*\*remote control not available

\*ac input voltage option must be specified when ordering

## Option Descriptions

**Opt 011** internal overvoltage protection crowbar. Protects delicate loads against power supply failure or operator error. Dual output model has dual crowbar.

HP 6200B, 6206B

HP 6205C

+\$105

+\$210

\$0

**Opt 028** 230 Vac ± 10%, single phase input. Consists of reconnecting power transformer taps, and other components where necessary.

**Opt 040** Multiprogrammer interface. Prepares HP 6205C power supplies for resistance programming by the HP 6942A, 6944A or 6954A Multiprogrammer

+\$80

**Opt 100** 87-106 Vac, 47-63 Hz, single phase input

\$0

**Opt 220** 191-233 Vac, 47-63 Hz, single phase input

\$0

**Opt 240** 208-250 Vac, 47-63 Hz, single phase input

\$0

**Opt 910** one additional operating and service manual is shipped with each power supply

HP 6200B-6237B

+\$5.35

## Accessories

**HP 14513A:** rack kit for one HP 6200-6209B, 6236B, or 6237B supply

\$90

**HP 14523A:** rack kit for two of the above power supplies

\$50

**HP 14521C:** rack kit for one, two or three HP 6212C-6218C power supplies

\$130

☎ For same-day shipment, call HP DIRECT at 800-538-8787

# POWER SUPPLIES

## Special Purpose: DC Power Supply/Amplifiers

HP 6825A-6827A

503

- High speed remote programming
- Overload protection
- Wide-band response
- Bipolar voltage
- Current sink or source



HP 6825A-6827A

### Power Supply/Amplifiers

The Power Supply/Amplifier is a general-purpose instrument useful in any laboratory engaged in research and development of electronic systems, circuitry, or components. The unit can be operated in one of two basic operating modes: power supply or amplifier. Terminals at the rear permit access to various internal control points to further expand the operational capabilities of the instrument. The resulting flexibility lends the Power Supply/Amplifier to an almost unlimited number of applications.

### Models 6825A Through 6827A

These models feature dual-range output and constant-voltage/constant-current operation. Output voltage and current as a dc supply, or gain as a power amplifier, are remotely controllable and are compatible with Hewlett-Packard Multiprogrammer Systems.

The unit can furnish a bipolar, constant-voltage or constant-current output. It can be remotely programmed with a resistance, voltage, or current and its high speed programming characteristics adapt it to a wide variety of laboratory and production testing applications. The unit can sink, as well as source, current permitting it to serve as a variable load device.

As a direct-coupled power amplifier, each unit offers a signal-to-noise ratio of approximately 80 dB at full output with low distortion and a frequency response up to 40 kHz in the fixed gain mode.

### General Specifications

**Temperature:** operating, 0 to 55°C; storage, -40 to +75°C.

**Power:** HP 6825A, 6826A, 6827A, switchable, 100, 120, 220, or 240 V ac, -13% +6%, 48-63 Hz, 150 W.

**Size:** HP 6825A, 6826A & 6827A, 155 H x 198 W x 316 mm D (6<sup>7</sup>/<sub>32</sub>" x 7<sup>25</sup>/<sub>32</sub>" x 12<sup>7</sup>/<sub>16</sub>").

**Weight:** 6825A, 6826A & 6827A, 8.2 kg (18 lb).

### Specifications

RATINGS		POWER SUPPLY PERFORMANCE						POWER AMPLIFIER PERFORMANCE						Options	Price	
DC Output		HP Model	PAR (rms/p-p)		Transient Recovery		Resolution		Voltage Gain		Frequency Response, +1, -3 dB		Distortion at full output			
Volts	Amperes		Voltage	Current	Time	Level	Voltage	Current	Fixed	Variable	Fixed Gain	Variable Gain	100 Hz	10 kHz		
-5 V to +5 V/ -20 V to +20 V	0-2.0 A Both Ranges	6825A	10/30 mV	5/15 mA	100 μs	20 mV	40 mV	6 mA	1X 4X	0-2X 0-8X	dc-40 kHz	dc-15 kHz	0.1% THD	0.5%	910	\$2830
-5 V to +5 V/ -50 V to +50 V	0-1.0 A Both Ranges	6826A	6/35 mV	0.8/5 mA	100 μs	50 mV	100 mV	3 mA	1X 10X	0-2X 0-20X	dc-40 kHz	dc-15 kHz	0.1% THD	0.5%	910	\$2830
-10 V to +10 V/ -100 V to +100 V	0-0.5 A Both Ranges	6827A	10/50 mV	0.4/5 mA	100 μs	100 mV	200 mV	1.5 mA	2X 20X	0-4X 0-40X	dc-30 kHz	dc-15 kHz	0.1% THD	1%	910	\$2830

### Options Descriptions

**910:** one additional manual shipped with each power supply

**Price**  
add \$15

### Accessories

**HP 5060-8762:** adapter frame for rack mounting one or two HP 6825A-6827A units

**HP 5060-8760:** blank filler panel to be used with above units

**Price**  
\$150 ☎

\$44 ☎

☎ For same-day shipment, call HP DIRECT at 800-538-8787

# POWER SUPPLIES

## Special Purpose: Precision Voltage Sources

HP 6114A and 6115A

- 0.025% output voltage accuracy
- Pushbutton voltage control
- Five minute warm-up



HP 6114A & 6115A

### Description

#### HP Models 6114A and 6115A

These 40-watt precision power supplies are high-accuracy instruments designed for use as low-cost calibrators, working voltage standards, systems reference supplies, or high-performance lab supplies. They are ideal for applications where an accurate, highly stable, and easy-to-use source of dc voltage is required.

#### Output Ratings

Both models feature automatic dual-range operation. For example, the HP 6114A can supply 0-20V at 0-2A, and 20-40V at 0-1A, without manual range switching. Automatic output current range cross-over occurs when the supply is providing greater than one-half of the maximum rated output voltage.

#### Output Voltage Controls

Pushbutton voltage controls allow the output voltage to be set rapidly and accurately. The setting is displayed in large, easy-to-read numerals. A four-digit pushbutton switch increases or decreases the output voltage in unit steps, and the switches go directly from "9" to "0" without backing down. A fifth digit, set via a separate front-panel control, provides output voltage resolution of 200  $\mu$ V.

The output voltage accuracy is 0.025% (250 ppm) plus 1 mV — for example, at 40 volts output, the output voltage of Model 6114A is accurate within  $\pm 11$  mV. This accuracy is attained after only five minutes' warmup, thus making these supplies especially suitable as portable calibrators.

#### Output Current Controls

A front-panel current control allows the maximum output current of these supplies to be set to any desired value within the maximum rating. Using this control, the supplies can be operated as constant-current sources with 0.01% current regulation. A current mode indicator (a light-emitting diode) immediately lights when the supply is operated in the gross current limit region or when the output current level established by the setting of the front-panel control is reached. When the indicator is lighted, the output voltage is uncalibrated, but the front panel voltmeter continues to indicate the output voltage with an accuracy of 2%. A ten-turn current control with a three-digit graduated dial provides 2 mA current resolution.

#### Remote Programming

Models 6114A and 6115A are designed to be programmed with either the HP Multiprogrammer or the HP-IB Isolated D/A Power Supply Programmer. Interfacing for Multiprogrammer operation is included as a standard feature in these models; therefore, the addition of Option 040 is not required. Both supplies can also be remote programmed by means of an external voltage or resistance. However, most specifications will change to those of the programming source.

The output capacitor can be disconnected to reduce current surges, thereby improving the performance of the supply as a constant-current source; this also increases the programming speed by approximately an order of magnitude. Note, however, that some capacitance

- May be used with HP-IB Power Supply Programmer
- Overvoltage and overcurrent indicators
- Built-in overvoltage crowbar

at the load may be required to maintain power supply stability under all loading conditions when the output capacitor is disconnected.

#### Overvoltage Protection

A built-in overvoltage protection circuit (an SCR crowbar) monitors the output and reduces the output voltage and current to zero whenever a preset voltage limit (adjustable from the front panel) is exceeded. This feature provides a convenient method of limiting the maximum output voltage supplied to voltage-sensitive loads.

#### Specifications

**DC Output:** voltage and current output can be adjusted over the range indicated by front-panel controls or analog programming.

**HP 6114A:** 0-20 volts, 0-2 amperes  
20-40 volts, 0-1 amperes

**HP 6115A:** 0- 50 volts, 0-0.8 amperes  
50-100 volts, 0-0.4 amperes

Both models feature automatic dual-range operation, which eliminates manual range switching.

**Load effect:** constant-voltage deviation, 0.0005% + 100  $\mu$ V. constant-current deviation, 0.01% + 500  $\mu$ A.

**Source effect:** over the rated input voltage range: constant-voltage, 0.0005% + 100  $\mu$ V; constant-current, 0.005% + 40  $\mu$ A.

**Ripple and noise (PAR):** rms/p-p, 20 Hz to 20 MHz; CV 40  $\mu$ V/200  $\mu$ V, CC 200  $\mu$ A/1 mA.

**Temperature coefficient:** CV, 0.0001% + 15  $\mu$ V/ $^{\circ}$ C; CC, 0.02% + 50  $\mu$ A/ $^{\circ}$ C.

**Drift:** CV, 0.0015% + 15  $\mu$ V per 8 hours, 0.0075% + 30  $\mu$ V per 90 days.

**Output voltage accuracy:** output voltage accuracy obtained from front-panel controls at  $23 \pm 3^{\circ}$ C at any ac line voltage and load current within rating and following a five-minute warm-up: 0.025% + 1.0 mV.

**Resolution:** front-panel voltage control, 200  $\mu$ V; front-panel current control, 2 mA.

**Output impedance:** typical value is approximated by 0.05 m $\Omega$  in series with 3 mH.

**Load transient recovery time:** less than 50  $\mu$ s is required for output voltage (constant voltage operation) to recover within 50 mV of the nominal output level following a change in output current equal to the current rating of the supply.

**Remote programming speed:** up programming of voltage at full load: HP 6114A, 1.75s; HP 6115A, 4.5s. Down programming, no load: HP 6114A, 350 ms; HP 6115A, 500 ms.

**Overvoltage protection crowbar:** adjustable front-panel screwdriver control from 0.5 to 45 volts on the HP 6114A and 0.5 to 110 volts on the HP 6115A.

**Power:** 104-127 or 208-254 Vac (switchable), 48-440Hz, 150 VA max.

**Temperature rating:** operating, 0 to 50 $^{\circ}$ C; storage, -40 to +75 $^{\circ}$ C.

**Size:** 197 mm W x 165 mm H x 337mm D (7.75" x 6.5" x 13.25")

**Weight:** 7.7 kg (17 lb) net, 9.5 kg (21 lb) shipping.

#### Accessories

**5060-8762:** adapter frame for rack mounting one or two  $\frac{1}{2}$  rack width units. This frame applies to HP 6114A, 6115A

**5060-8760:** blank filler panel. This  $\frac{1}{2}$  rack width panel applies to HP 6114A, 6115A

**Price**  
\$150 ☎

\$44 ☎

#### Ordering Information

HP 6114A Precision Power Supply \$2300

HP 6115A Precision Power Supply \$2300

Opt 910 Extra Operating and Service Manual \$10

☎ For same-day shipment, call HP DIRECT at 800-538-8787



# POWER SUPPLIES

## Special Purpose: Precision Constant Current Sources HP 6177C, 6181C & 6186C

505

- Continuously variable voltage limit
- Output useful to micro-ampere region

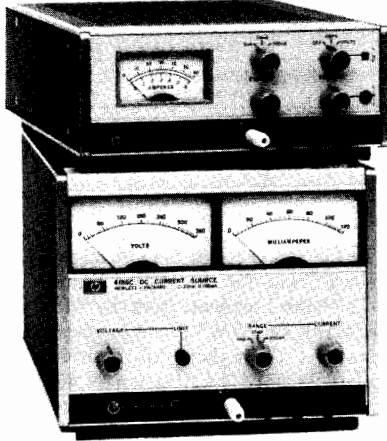

HP 6177C, 6181C

HP 6186C

- High output impedance—no output capacitor

voltage to vary from zero to maximum.

**Source effect (line regulation):** less than 25 ppm of output + 5 ppm of range switch setting for any change in the line voltage between 104 and 127 V ac at any output current and voltage within rating.

**Load effect transient recovery:** less than 800  $\mu$ s for recovery to within 1% of nominal output current following a full load change in output voltage. (On HP 6186C, recovery time for 100 mA/10 mA/1 mA ranges is 1 ms/1.6 ms/4 ms, respectively.)

**Temperature coefficient:** output change per degree C is less than 75 ppm of output current + 5 ppm of range switch setting.

**Drift (stability):** less than 100 ppm of output current + 25 ppm of range switch setting. Stability is measured for eight hours after one hour warm-up under conditions of constant line, load, temperature, and output setting.

**Resolution:** 0.03% of range switch setting.

**Temperature rating:** operating 0, to 55°C; storage, -40 to +75°C.

These solid-state constant-current sources are ideal for semiconductor circuit development, component testing, and precision electroplating applications.

Their high-speed remote programming characteristics make these supplies useful in testing and sorting semiconductors, resistors, relays, meters, etc. The ability to superimpose ac modulation on the dc output permits the supplies to be used for measurement of dynamic or incremental impedance of circuit components. When remotely programmed, accuracy, stability and some other specifications change to those of the programming source. The output current is continuously variable with the ten-turn front panel control.

### Specifications

**Load effect (load regulation):** less than 25 ppm of output + 5 ppm of range switch setting for a load change which causes the output

### Ordering Information

HP 6177C, 6181C Constant Current Source

Price

HP 6186C Constant Current Source

\$2050

Opt 028 230 Vac  $\pm$ 10%, single-phase input.

\$2780

Opt 910 one additional operating and service manual

\$0

+ \$7.88

### Accessories

HP 5060-8764: rack adapter for rack mounting one or two HP 6177C or 6181C supplies

\$150 ☎

HP 5060-8762: rack adapter for rack mounting one or two HP 6186C supplies

\$150 ☎

HP 5060-8530: filler panel for HP 6177C, 6181C

\$100 ☎

HP 5060-8760: filler panel for HP 6186C

\$44 ☎

Model		HP 6177C	HP 6181C	HP 6186C	
Output Current ††		0-500 mA	0-250 mA	0-100 mA	
Voltage Compliance $\Delta$		0-50 V dc	0-100 V dc	0-300 V dc	
Output Ranges		A 0-5 mA	0-2.5 mA	0-1 mA	
		B 0-50 mA	0-25 mA	0-10 mA	
		C 0-500 mA	0-250 mA	0-100 mA	
AC Input		115V ac $\pm$ 10%, 48-63 Hz; 0.6 A, 55 W at 115 V ac For 230 V ac see Option 028	115 V ac $\pm$ 10%, 48-63 Hz; 0.6 A, 55 W at 115 V ac For 230 V ac see Option 028	115/230 V ac, 48-63 Hz; 0.9 A, 90 W at 115 V ac 115/230 V ac switch	
Constant Current	Voltage Control (accuracy: 0.5% of output current + 0.04% of range)	Range A 200 mV/mA	1 V/mA	10 V/mA	
		Range B 20 mV/mA	100 mV/mA	1 V/mA	
		Range C 2 mV/mA	10 mV/mA	100 mV/mA	
Remote Programming	Resistance Control (accuracy: 1% of output current + 0.04% of range)	Range A 400 ohms/mA	2 k $\Omega$ /mA	10 k $\Omega$ /mA	
		Range B 40 ohms/mA	200 ohms/mA	1 k $\Omega$ /mA	
		Range C 4 ohms/mA	20 ohms/mA	100 $\Omega$ /mA	
Voltage Limit Remote Programming	Voltage Control (Accuracy: 20%)	1 V/V	1 V/V	1 V/V	
		Resistance Control	870 ohms/V	435 ohms/V	820 ohms/V
		Accuracy	25%	25%	15%
Typical Output Impedance (R in parallel with C)*	Range A	R = 330 Meg, C = 500 pF	R = 1330 Meg, C = 10 pF	R = 10,000 Meg, C = 900 pF	
	Range B	R = 33 Meg, C = 0.005 $\mu$ F	R = 133 Meg, C = 100 pF	R = 1,000 Meg, C = 700 pF	
	Range C	R = 3.3 Meg, C = 0.05 $\mu$ F	R = 13.3 Meg, C = 1000 pF	R = 100 Meg, C = 1500 pF	
PARD (Ripple and Noise): rms/p-p (20 Hz to 20 MHz) with either output terminal grounded	Range A	1.6 $\mu$ A rms/40 $\mu$ A p-p	0.8 $\mu$ A rms/20 $\mu$ A p-p	0.2 $\mu$ A rms/5 $\mu$ A p-p	
	Range B	16 $\mu$ A rms/200 $\mu$ A p-p	8 $\mu$ A rms/100 $\mu$ A p-p	2 $\mu$ A rms/50 $\mu$ A p-p	
	Range C	160 $\mu$ A rms/1 mA p-p	80 $\mu$ A rms/500 $\mu$ A p-p	20 $\mu$ A rms/500 $\mu$ A p-p	
Programming Speed: from 0 to 99% of range switch setting with a resistive load **(Output Current Modulation)		6 ms	6 ms	10 ms	
Dimensions:		7.75" (W) x 3.44" (H) x 12.38" (D) 197 mm (W) x 88 mm (H) x 315 mm (D)	7.75" (W) x 3.44" (H) x 12.38" (D) 197 mm (W) x 88 mm (H) x 315 mm (D)	7.75" (W) x 3.44" (H) x 12.38" (D) 197 mm (W) x 158 mm (H) x 315 mm (D)	
Weight: (Net/Shipping)		4.53 kg (10 lb)/5.9 kg (13 lb)	4.53 kg (10 lb)/5.9 kg (13 lb)	5.9 kg (13 lb)/7.7 kg (17 lb)	

\* This network is a simplified representation of a complex network. The formula  $Z = R\sqrt{1 + R^2/C^2}$  is used for frequencies up to 1 MHz by substituting the values given for R and C. Above 1 MHz, the output impedance is greater than the formula would indicate.

\*\* Output current can be modulated 100% up to 50 Hz; percent modulation decreases

linearly to 10% at 500 Hz.

†† For operation above 40°C the maximum output current must be reduced linearly to 80% of rating at 55°C (maximum temperature).

$\Delta$  Minimum voltage obtainable with voltage limit control is 0.5 V.

☎ For same-day shipment, call HP DIRECT at 800-538-8787

# FREQUENCY & TIME STANDARDS

## General Information

Hewlett-Packard offers frequency standards and clocks which provide accurate frequency, time interval and timekeeping capabilities. Further, Hewlett-Packard standards provide means for comparing these quantities against national standards such as the U.S. National Institute of Standards and Technology (NIST) and the U.S. Naval Observatory (USNO). Units of frequency or time cannot be kept in a vault for ready reference. They must be generated for each use, hence be regularly compared against recognized primary standards.

Frequency standards and clock systems manufactured by Hewlett-Packard are used for control and calibration at observatories, national centers for measurement standards, physical research laboratories, missile and satellite tracking stations, communication systems, radio navigation systems, manufacturing plants and radio monitoring and transmitting stations.

### Types of Frequency Standards

At the present time, three types of frequency standards are in common use. These are:

1. The cesium atomic beam controlled oscillator.
2. The rubidium gas cell controlled oscillator, and
3. The quartz crystal oscillator.

Hewlett-Packard manufactures all three types of frequency standards. Of these three standards, the first is a primary frequency standard and the last two are secondary frequency standards. The distinction between a primary standard and a secondary standard is that the primary standard does not require any other reference for calibration; whereas the secondary standard requires calibrations both during manufacturing and at intervals during use depending on the accuracy desired.

### Cesium Beam Frequency Standard

Cesium beam standards are in use wherever the goal is a very high accuracy primary frequency standard. In fact, the NIST frequency standard itself is of the cesium beam type. The cesium beam standard is an atomic resonance device which provides access to one of nature's invariant frequencies in accord with the principles of quantum mechanics. The cesium standard is a true primary standard and requires no other reference for calibration.

### Rubidium Frequency Standard

Rubidium frequency standards feature a high order of both short-term and long-term frequency stability. These are both important in certain fields such as deep-space communications, satellite ranging, and doppler radar.

Rubidium standards are similar to cesium beam standards in that an atomic resonant element prevents drift of a quartz oscillator through a frequency lock-loop. Yet the rubidium gas cell is dependent upon gas mixture and gas pressure in the cell. It must be calibrated and then it is subject to a small degree of drift. The drift is typically 100 times less than the best quartz crystal standard.

TABLE 1 Comparison of Frequency Standards

Standard	Principal construction feature	Principal advantage
Cesium Atomic Beam Resonator Controlled Oscillator.	Beam of free cesium atoms, spatially state selected, is subjected to a microwave signal at resonance frequency.	High intrinsic reproducibility and long-term stability. Designated as primary standard for definition of time interval.
Rubidium Gas Cell Resonator Controlled Oscillator.	Gas buffered resonance cell with optically pumped state selection.	Compact and light weight. High degree of short-term stability.
Quartz Crystal Oscillator.	Piezoelectrically active quartz crystal with electronic stabilization.	Very compact, light and rugged. Inexpensive.

### Quartz Crystal Oscillators

Quartz oscillators are used in virtually every frequency control application including atomic standards. The excellent short-term stability and spectral purity of the quartz oscillators used in Hewlett-Packard atomic standards contribute to the high quality of the output signal of these standards. For less demanding applications where some long-term drift can be tolerated, quartz oscillators are used as independent frequency sources.

### Frequency Standards and Clocks

Frequency standards and clocks have no fundamental differences—they are based upon dual aspects of the same phenomenon. Time and frequency are intangible quantities which can be measured only with respect to some physical quantity. The basic unit of time, the second, is defined as the duration of 9,192,631,770 periods of transition within the cesium atom. Conversely an unknown frequency is determined by counting the number of cycles over the period of a second. The Master Clock at the USNO, one of the world's most accurate clocks, is made of an ensemble of more than a dozen Hewlett-Packard cesium beam frequency standards. The USNO directly controls the distribution of precise time and time interval (frequency) from Naval radio stations, Loran-C (operated by U.S. Coast Guard), Omega and Satellite Navigation Systems. Hewlett-Packard portable cesium standards, "flying clocks," are used to periodically check the synchronization between these stations and the Master Clock.

Hewlett-Packard cesium beam standards are widely used to drive precision clocks because of the extremely good long-term stability and reliability of this primary standard. If a quartz oscillator or other secondary standard is used, it must be evaluated for rate of drift and be corrected periodically.

### Time Scale

The time interval of the atomic time scale is the International Second, defined in October 1967 by the Thirteenth General Conference of Weights and Measures. Since January 1972 the frequency offset between UTC and Atomic Time has been zero and the UTC time scale is kept in synchronism with the rotation of the earth to within  $\pm 0.9$  second by step-time adjustments of exactly 1 second, when needed (see Hewlett-Packard Application Note 52-2).

The USNO provides the official basis for Standard Time for the United States. The UTC signal is broadcast from the NIST stations WWV and WWVB and by several other stations throughout the world. (See Hewlett-Packard Application Note 52-1, Fundamentals of Time and Frequency Standards, for a list of stations broadcasting time signals).

### Standby Power Supplies

Minimum down-time, important for any system, is vital to a time standard. Its worth depends directly on continuity of operation. Noninterrupted operation is also important to ultra-precise quartz oscillators.

Hewlett-Packard standby power supplies ensure continued operation despite line interruptions, and operate over a range of ac line voltage to supply regulated dc to operate frequency standards and frequency dividers and clocks. The batteries in the supplies assume the full load immediately when ac power fails.

### Hewlett-Packard Time and Frequency Standard

The Hewlett-Packard House Standard at the Santa Clara Division consists of an ensemble of five Hewlett-Packard Cesium Beam Standards each with the Option 004 High Performance Tube.

The standard is compared to the U.S. Naval Observatory Master Clock in Washington, D.C. by means of the Global Positioning (GPS) navigation system. It is also compared with the NIST Frequency Standard at Boulder, Colorado by means of GPS through the Naval Observatory. The frequency uncertainty of the standard is within a few parts in  $10^{13}$  with respect to the standards maintained by the NIST and the USNO.

Time is maintained relative to the USNO and the NIST master clocks to an accuracy of better than  $\pm 1.0$  microseconds. This accuracy is verified with flying clock trips from the Naval Observatory to both Hewlett-Packard Santa Clara Division and Hewlett-Packard Geneva. Both locations have been designated U.S. Naval Observatory Time Reference Stations.

# FREQUENCY & TIME STANDARDS

Frequency Standards

HP 5061B, 5065A, 105B

507

## Specifications — Frequency Standards

Instrument:	HP 5061B Option 004	HP 5061B	HP 5065A	HP 105B
Type of Standard:	Cesium	Cesium	Rubidium	Quartz
Accuracy: maintained in a dc magnetic field to 2 gauss over a temperature range of 0-50°C	$\pm 3 \times 10^{-12}$	$\pm 5 \times 10^{-12}$		
Accuracy: limited temp. range <sup>(1)</sup>	$\pm 2 \times 10^{-12}$	$\pm 3 \times 10^{-12}$		$5 \times 10^{-10}$ /day
Reproducibility	$\pm 1.5 \times 10^{-12}$	$\pm 3 \times 10^{-12}$		
Retrace	$\pm 5 \times 10^{-13}$	$\pm 3 \times 10^{-12}$		
Settability (frequency)	$\pm 1 \times 10^{-13}$	$\pm 7 \times 10^{-13}$	$\pm 2 \times 10^{-12}$	$1 \times 10^{-10}$
Long-term Stability	$\pm 2 \times 10^{-12}$ <sup>(4)</sup>	$\pm 2 \times 10^{-12}$ <sup>(4)</sup>	$\pm 1 \times 10^{-11}$ /month	
DC Magnetic Field Stability, freq. change, any orientation in a 2 gauss field	$< \pm 2 \times 10^{-13}$	$< \pm 2 \times 10^{-12}$	$< \pm 5 \times 10^{-12}$ (1 gauss field)	
Time Constant, quartz OSC. control loop	1s	1s		
Warm-up Time at 25°C	30 min	45 min	$5 \times 10^{-11}$ 4 hrs <sup>(2)</sup>	$5 \times 10^{-9}$ /15 min
Tube Warranty	3 yrs.	5 yrs.	3 yrs.	
Sinusoidal Outputs	10 MHz, 5 MHz, 1 MHz, 100 kHz		5 MHz, 1 MHz, 100 KHz	5M, 1M, 100k, Clock (1M)
Output Voltage	1 volt into 50 $\Omega$			
Harmonic Distortion	>40 dB (from rated output)			
Non-Harmonic Distortion	>80 dB (from rated output)			
Temperature, Operating	0-50°C			
Temperature, Non-operating	-40 to 70°C <sup>(3)</sup>			-40 to 50°C
Power, AC	50, 60 or 400 Hz $\pm 10\%$ , 115/230V $\pm 10\%$ , 44W (Cesium), 49W (Rb),			19W(71W Warm-up)
Power, DC	22 to 30V, 30W		23 to 30V, 35W	8W (16W Warm-up)
Power, AC/DC with options - add	5 to 16W		0 to 16W	
Dimensions (HxWxD): mm:	221x425x416		133x425x416	88.2x425x286
inches:	8.7x16.7x16.4		5.2x16.7x16.4	3 <sup>5</sup> / <sub>32</sub> x16 <sup>3</sup> / <sub>4</sub> x11 <sup>1</sup> / <sub>4</sub>
Weight (lb/kg)	68/30.9	64/29.1	34/15.4	24/10.9
Option 002			2/0.9	
Option 003	6/2.7	6/2.7	3.5/1.6	
Time Standard (Clock)				
1 PPS Outputs: Master:	Front and Rear BNC		Front BNC	
Clock:				
Amplitude	10V Peak into 50 $\Omega$ load			
Width	20 $\mu$ s min.			
Rise Time	<50 ns			
Fall Time	<50 ns			
Jitter, pulse-to-pulse	<1 ns, rms			
Synchronization	Automatic, 100 $\pm$ 100 ns delay			
Clock Pulse Adjustment Range:	.1 $\mu$ s to 1s			
Clock Display:	LCD	LCD	LED	
Standby Power Supply-Capacity at 25°C w/clk	45 min.	45 min.	10 min.	6 hrs
Recharge	Automatic		switch	fast/float
(1) Static mechanical and atmospheric and electromagnetic environment $\pm 2.5^\circ\text{C}$ range at any temperature between 15 and 35°C.				
(2) After 24 hours off @ 25°C.				
(3) If options installed in HP 5065A, Non-Op. Temp -40°C to +50°C.				
(4) For life of Cesium Beam tube.				
NOTE: Tubes are intrinsically capable of meeting these specifications when installed in HP 5061B's currently in production.				

### Ordering Information

HP 5061B Cesium Frequency Standard	\$38,700
Opt 003 Clock and Standby Power Supply	\$4,800
Opt 004 High Performance Beam Tube	\$6,900
Opt 908 Rack Flange Kit	\$80
Special Option HP E21-5061B Flying Clock	+\$8,550
Consists of: HP5061B, Opt 003, E21, + 5089A.	
(The 5061B, + Opt 003 are not included in the E21 price.)	
Weight: 64 kg (141 lb).	
Size: 425 H x 405 W x 546 mm D (16.7 in. x 15.9 x 21.5 inches) includes handles.	
HP 10638A Degausser	\$2,300

Special Option K34-59991A Phase Comparator	\$2,700
HP 5065A Rubidium Frequency Standard	\$36,200
Opt 001 Clock	+\$4,100
Opt 002 Standby Power Supply	+\$1,700
Opt 003 Clock and Standby Power Supply	+\$5,700
Opt 908 Rack Flange Kit	+\$90
Special Option HP E21-5065A Portable Standard	+\$8,550
Consists of: HP 5065A, E21, Opt 001 + 5089A	
Standby power supply. (The 5065A, + Opt 001 are not included in the E21 price.)	
Weight: 50 kg (110 lb).	
Size: 314 H x 425 W x 546 mm D (8.4 x 16.7 x 21.5 inches) includes handles.	

# FREQUENCY & TIME STANDARDS

## Primary Standards

### HP 5061B

- HP 5061B
- Accuracy  $\pm 3 \times 10^{-12}$
- Primary standard
- Proven reliability

- HP 5061B, Opt 004
- Improved accuracy  $\pm 2 \times 10^{-12}$
- Settability  $\pm 1 \times 10^{-13}$
- Time domain stability  $5 \times 10^{-12}$  (1 s avg)

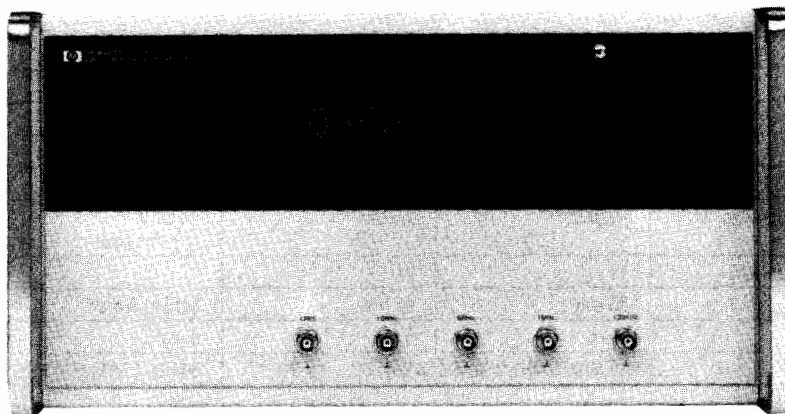

HP 5061B (shown with Option 003)

### HP 5061B Cesium Beam Standard

The first Hewlett-Packard Cesium Beam Standard, the HP 5060A, was introduced in 1964. This was followed in 1967 with the improved HP 5061A, in 1973 with the high performance beam tube option for the HP 5061A and in 1986 with the 5061B. Since this time the accuracy and reliability of Hewlett-Packard cesium beam standards continues to be demonstrated and these standards have become the world-wide standard for frequency and time keeping. The HP 5061B has provision for an optional digital divider and reliable, easy-to-read LCD clock (Option 003) and for a battery with 3/4 hour standby power capacity with automatic charging.

**Reliability and warranty:** over 100 million operation hours have proven the performance and reliability of Hewlett-Packard cesium beam standards in various world-wide applications. The units have provided dependable microsecond accuracy in aircraft, ship and fixed environments.

A five-year warranty on the HP 5061B standard cesium beam tube is provided as a result of proven field reliability. This warranty includes replacement of the cesium beam tube if it should fail within the warranty period.

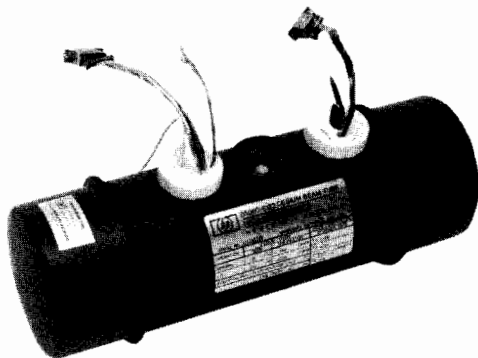

Option 004, High Performance Cesium Beam Tube with three-year warranty

### HP 5061B with Opt 004, High Performance Cesium Beam Tube

The Hewlett-Packard 5061B primary frequency standard with the Option 004 Cesium Beam Tube offers increased stability and accuracy in the instrument which has become the worldwide standard of frequency and time keeping since its introduction in 1967. Improvements in magnetic shielding, ruggedization and environmental performance permit improved performance and expansion of navigation and communication systems.

The design concept of the high-performance beam tube includes unique HP designed dual-beam optics with higher beam intensity to accomplish better short-term stability and greater immunity to effects of shock and vibration. A 50 percent increase in resonance cavity length without change in the overall beam tube size contributes to better accuracy and settability because of the high Q of the narrower resonant line width. This tube retains the unique cesium standard feature of virtually no long term instability or aging.

The intrinsic accuracy is improved to  $\pm 2 \times 10^{-12}$  which provides an excellent reference standard without need of calibration. If desired, as in many timekeeping applications, two or more units may be calibrated to determine the difference in rate or may be adjusted to the same frequency. With the improved settability specifications of  $1 \times 10^{-13}$  small changes in frequency are accomplished rapidly and accurately. A provision for degaussing the tube without adversely affecting the instrument operation allows removal of any residual magnetic field in the tube. This is important in achieving the settability performance.

The short term stability specification is improved by a factor of ten with this tube. The  $5 \times 10^{-12}$  (1 s avg.) performance compares very favorably with that of rubidium type standards which are noted for their excellent short term stability. An important advantage from the better short term stability is the capability to make measurements to 1 sigma precision of  $1 \times 10^{-12}$  in about one minute compared to the two hours required previously. The HP 5061B with the Option 004 High Performance Tube has the same high reliability as the HP 5061B with the standard tube. The new high performance tube is warranted for three years, but is designed to have the same long life as the standard tube.\*

### HP E21-5061B Flying Clock

The HP E21-5061B consists of a HP 5061B Cesium Beam Standard with Option 003 LCD Clock and Special Option E21, all fastened to an HP 5089A Standby to form a portable unit. The power supply, which can be operated from 11 to 30 V dc, 85 to 255 V ac, will provide approximately 10 hours standby power (from sealed immobilized electrolyte lead calcium batteries) for the HP 5061B Cesium Beam Standard.

This wide range of operating power capabilities enable the HP E21-5061B to operate on local power in virtually any country in the world. The 10 hours standby capability makes it possible to travel where there is no power available and, of course, allows the HP E21-5061B to conveniently be transported between power sources and operated in almost any air or surface vehicle as a "flying clock" (see Hewlett-Packard Journal, August 1966 and December 1967).

The Option 004 tube, because of the improved shielding, offers a significant increase in accuracy under the varying earth's magnetic field conditions experienced by flying clocks and is a desirable addition to the HP E21-5061B. In addition, the better short term stability permits more accurate and rapid comparison of standards.

\*See page 507 for ordering information.

- Compact, high reliability, proven performance
- Long term drift rate  $< 1 \times 10^{-11}$ /month
- Time domain stability  $< 5 \times 10^{-13}$  (100 s, avg)
- High reliability

- Proven performance
- Compact
- Long-term drift rate  $< 1 \times 10^{-11}$ /month
- Time domain stability  $< 5 \times 10^{-13}$  (100 s, avg.)

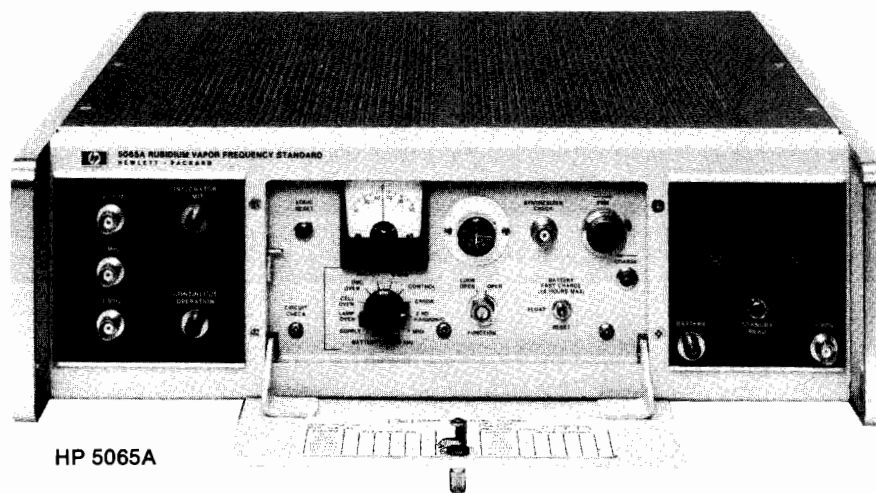

### HP 5065A Rubidium Frequency Standard

The HP 5065A is an atomic-type secondary frequency standard which uses a rubidium vapor resonance cell as the stabilizing element. As a result, it has long-term stability of better than  $1 \times 10^{-11}$  per month which exceeds that of high quality quartz oscillator frequency standards by 50 to 100 times. Furthermore, it has excellent short-term stability. These features contribute to its desirability as a coherent signal source, as a master oscillator for radio and radar systems where special requirements for stability and/or narrow bandwidth must be met, as a precision time keeper where the better performance of a cesium beam primary standard is not required, and as a house frequency standard for improved accuracy with fewer NIST calibrations compared to that required with quartz standards.

Front panel controls and circuit check meter of the HP 5065A are protected by a panel door. The magnetic field control provides fine frequency adjustment with which the frequency can be set to a precision of better than  $2 \times 10^{-12}$  without reference to a chart. The low noise quartz oscillator is phase-locked to the atomic frequency and provides the standard 5 MHz, 1 MHz, and 100 kHz outputs. The circuit check meter with selector switch monitors key voltages and currents for routine maintenance readings, calibration procedures, and fault finding.

The HP 5065A is designed for assured operation—to give the user confidence that the standard output signals are correct and locked to the atomic frequency. Logic within the unit maintains power to a “continuous” operation light on the front panel. If operation is interrupted, even momentarily, for any reason the light goes out and stays out until manually reset. An integrator limit light warns when the frequency correcting servo loop is approaching the limit of its dynamic range.

The HP 5065A is contained in a small-size package and is lightweight in comparison to a cesium beam standard. Additionally the rubidium resonance cell is much more frequency stable than quartz oscillators while subjected to shock and vibration, EMC, humidity, and magnetic field effects.

**Reliability and warranty:** the most significant module in the HP 5065A in terms of performance is the Rubidium Vapor Frequency Reference (RVFR). This temperature controlled, magnetically shielded unit includes the Rb gas cell and a photo sensitive detector

designed for maximum possible reliability. Field experience, including several million hours of operation, have demonstrated this reliability and the RVFR is now warranted for a period of three years. This increased warranty protects the owner in the event of random failure.

The Option 001 Digital Clock has an easy to read LED time-of-day display. The olive black upper panel provides a dark background around the readout for excellent contrast and readability. Initial clock setting is accomplished by means of pushbuttons easily accessible by removing the top cover. The LED display offers high reliability, freedom from errors due to mechanical shock, and performance over the full environmental range of the HP 5065A. A sync button on the digital divider permits automatic synchronization of this 1 PPS pulse to an external pulse. The clock 1 PPS is adjustable in decade steps from 0.1  $\mu$ s to 1 s, with respect to the synchronized reference, with 7 thumbwheel switches.

To conserve battery power, the display is not illuminated when ac power is not available. A STANDBY READ pushbutton below the display is used for readout when operating on the internal battery or external dc.

The Option 002 Standby Battery provides the HP 5065A with a minimum of 10 minutes standby power at 25°C. Switchover from line to battery is automatic so there is no interruption of operation if ac line power should fail. A front panel ac interruption light warns when ac power has failed or has been disconnected. Fast or float charging rates may be selected when ac power is available.

The Option 003 combines the Option 001 Clock and Option 002 Battery and should be specified if both Options 001 and 002 are required.

### HP E21- 5065A Portable Time Standard

HP E21- 5065A Portable Time Standard is a complete system for precision timekeeping and for transporting time from one location to another. It consists of the HP 5065A Rubidium Standard with digital clock and divider (Option 001) and the HP 5089A Power Supply with 6 or more hours standby capability. The component units are held together by side bars, and the interconnecting cables are protected by a back cover.

# FREQUENCY & TIME STANDARDS

## Secondary Standards

### HP 105B

- High spectral purity
- Well-buffered outputs
- Aging  $< 5 \times 10^{-10}$  per day
- Excellent stability
- High reliability
- Built-in 6-hour standby battery

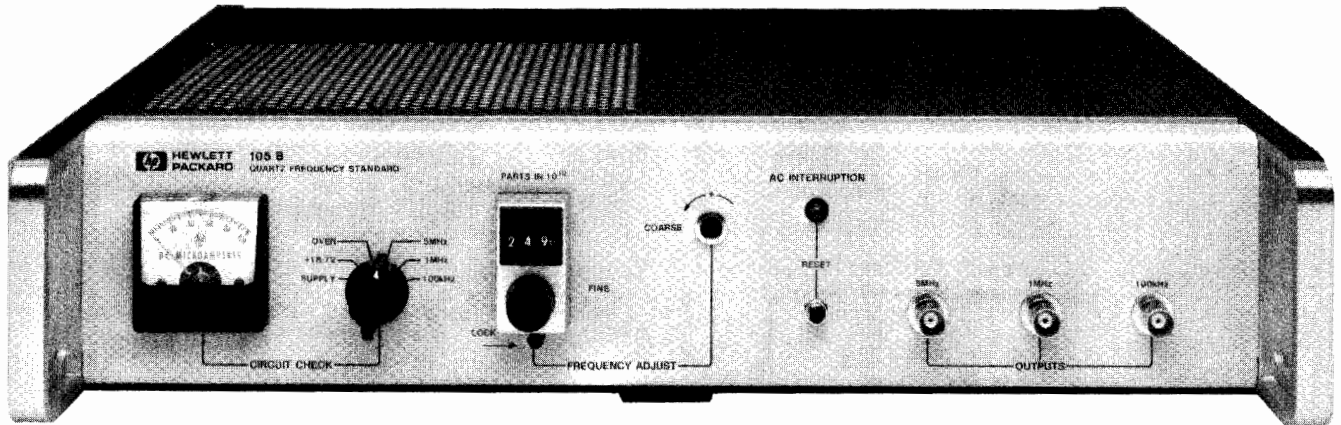

HP 105B

### HP 105B Quartz Frequency Standard

The HP 105B Quartz Frequency Standard provides state-of-the-art performance in precision frequency and time systems because of its excellent long and short term stability characteristics, spectrally pure output, unexcelled reliability, and ability to operate under a wide range of environmental conditions. The HP 105B fills a need for a small and economical yet highly stable precision reference for frequency and time standards. The HP 105B can be operated from the ac line. It also has a built-in 6-hour standby battery for uninterrupted operation should line power fail. The 5 MHz, 1 MHz and 100 kHz buffered sinusoidal outputs have excellent short term stability (5 parts in  $10^{12}$  rms for 1 s averaging time) and aging rate ( $< 1$  part in  $10^{11}$  per day).

The HP 105B features rapid warm-up. Typically, the standard will be within 5 parts in  $10^9$  of the final frequency in 15 minutes after an "off" period of 24 hours. The basis of this frequency standard is an extremely stable quartz crystal oscillator which uses an "SC" cut quartz crystal developed by Hewlett-Packard. New technologies in the crystal mounting and packaging have resulted in a cleaner crystal which in turn has a lower aging rate. The crystal, oscillator and AGC circuit are all enclosed in a proportional oven which reduces the temperature effects on these components and circuits.

Particular care was taken to provide a spectrally pure 5 MHz output which, when multiplied high into the microwave region, provides signals with spectra only a few cycles wide. Spectra less than 1 Hz wide can be obtained in X-band (8.2 to 12.4 GHz). The stability and purity of the 5 MHz output make it suitable for doppler measurements, microwave spectroscopy, and similar applications where the reference frequency must be multiplied by a large factor.

### Specifications

**Outputs:** 5 MHz, 1 MHz, 100 kHz; 1 V rms into 50  $\Omega$  front and rear connectors.

**Clock output:** 1 MHz or 100 kHz; 0.5 V rms into 1 k $\Omega$ , rear connector. Normally supplied wired for 1 MHz output.

### Frequency Stability

**Aging rate:**  $< 5 \times 10^{-10}$  per 24 hours.

### Short-term stability: for 5 MHz output only.

$\tau$ (sec)	$\sigma_{\Delta f}/f(2,\tau)$
$10^{-2}$	$1.5 \times 10^{-10}$
$10^{-1}$	$1.5 \times 10^{-11}$
$10^0$	$1 \times 10^{-11}$

**Temperature:**  $< 5 \times 10^{-9}$  total change  $0^\circ\text{C}$  to  $50^\circ\text{C}$ .

**Load:**  $< \pm 9 \times 10^{-11}$  open to short circuit, 50  $\Omega$  R, L or C load change.

**Supply voltage:**  $\pm 5 \times 10^{-11}$  for 22–30 V dc from 26 V dc reference and for 115/230 V  $\pm 10\%$ .

**Warm-up (at  $25^\circ\text{C}$ ):** to within  $1 \times 10^{-7}$  in 15 min.,  $1 \times 10^{-8}$  in 20 min.,  $1 \times 10^{-9}$  in 30 min. of final value (24 hours after turn-on).

### Distortion (5 MHz, 1 MHz, 100 kHz) Below Rated Output

**Harmonic:**  $> 40$  dB.

**Non-harmonic:**  $> 80$  dB.

### Frequency Adjustments

**Fine:**  $\pm 5 \times 10^{-8}$  range with digital dial reading parts in  $10^{10}$ .

**Coarse:**  $1 \times 10^{-6}$  front-panel screwdriver control.

**Phase locking:** external +5 V to –5 V allows  $> 2 \times 10^{-8}$  frequency control for locking to external source.

### Environmental

**Temperature, operating:**  $0^\circ\text{C}$  to  $+50^\circ\text{C}$ .

**Temperature, storage:**  $-40^\circ\text{C}$  to  $+50^\circ\text{C}$  ( $+75^\circ\text{C}$  without standby battery).

**Altitude:** 15.24 km (50,000 ft.).

**Standby supply capacity:** 6 hours at  $25^\circ\text{C}$  ambient temperatures.

**Power requirements:** 115/230 V  $\pm 10\%$ , Hz at 19 W (71 W warm-up) for float charge. 22–30 V dc at 8 W (16 W warm-up).

**Size:** 88 mm H x 425 mm W x 286 mm D ( $3\frac{1}{2}$  in. x  $1\frac{1}{4}$  in.).

**Weight:** 105B—net, 11 kg (24 lb). Shipping, 14 kg (31 lb).

### Ordering Information

HP 105B Quartz Frequency Standard

Opt 908 Rack Flange Kit

Opt 910 Extra manual

### Price

\$9,000

+ \$65

+ \$25



HP 10638A



HP K34-59991A

### HP 10638A Degausser

The HP 10638A Degausser is designed for use with the Option 004 High Performance Cesium Beam Tube without interrupting normal operation. The degausser removes residual magnetism in the shields of the beam tube which can build up over time, due to a changing magnetic environment, and can cause a frequency offset. Relaxation of the residual magnetism insures a settability of  $\pm 1 \times 10^{-13}$ , allowing stable precise changes in output frequency and a reproducibility of  $\pm 1.5 \times 10^{-12}$ . The degausser should be used when initially setting up the HP 5061B with Option 004 or after the instrument has been moved or adjusted.\*

### HP 5061B with Option 003, Time Standard and Standby Power Supply

The HP 5061B has provision for an optional digital divider and reliable, easy to read LCD, time-of-day, 24-hour digital clock (Option 003). By including this option, the number of applications and the versatility of the cesium standard is increased. The one-pulse-per-second output can simplify the comparison with other standards (such as portable and secondary standards) as well as GPS and Loran Systems. The techniques for such comparisons are described in Application Note AN 52-2. Option 003 also includes an internal battery power supply which will provide at least 45 minutes of standby power if the line power should fail. This will prevent phase and frequency interruptions due to intermittent or an extended power failure. Battery power also enables moving the cesium beam standard to locations of other secondary standards without losing time.\*

### HP K34-59991A Phase Comparator

The HP K34-59991A Broadband Linear Phase Comparator accurately compares the phase relationship of the output signals of two frequency standards having the same nominal frequency. This will enable resolving extremely small differences between precision frequency sources. The Phase Comparator operates over a frequency range of 10 kHz to 50 MHz and input levels between 100 mV and 10 V rms. A linear dc output voltage, proportional to the phase differences between the two standards, is available at both the front and rear panels. This voltage is also monitored on a front-panel meter and is suitable for driving a stripchart recorder, thus allowing longterm monitoring of the frequency standards. By using this comparator, very small frequency differences can be detected and adjustments can be made to frequency standards to correct for timekeeping errors.\*

### HP J45-5061 Certified Stability of $1 \times 10^{-13}$

The HP J45-5061B is a special option which will certify that the Model HP 5061B with standard Options 003 and 004 has stability performance of better than or equal to  $1 \times 10^{-13}$  in a day, when measured each day for any five consecutive days. This means that the cesium standards absolute deviation from the HP Santa Clara Division House Standard is less than or equal to 8.64 ns per day on each of the five consecutive days during the certification. The certification applies only to original shipments and is performed under calibration laboratory conditions with the cesium beam tube degaussed and operating in a stable magnetic environment and over a restricted temperature range of  $\pm 2.5$  degrees range at any temperature between 15 and 35 degrees C.

\* See page 507 for ordering information.

# FREQUENCY & TIME STANDARDS

## Accessories (cont'd)

### HP 5087A

- Versatile with 3 input and 12 output channels
- Low noise, high stability, and isolation
- Exceptional phase stability
- Plug-in modular construction

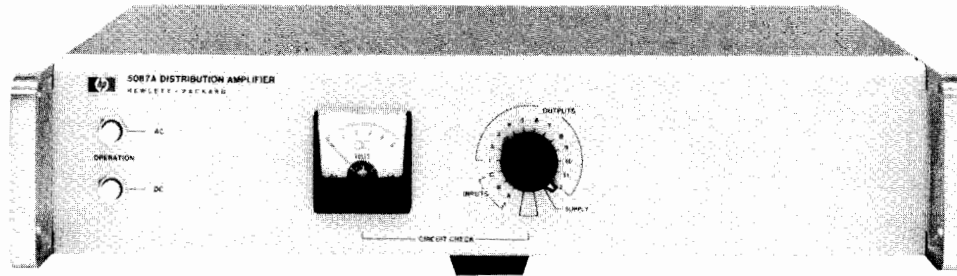

HP 5087A

### HP 5087A Distribution Amplifier

The Hewlett-Packard 5087A Distribution Amplifier provides the isolation and flexibility required for distribution of the output of high-quality frequency standards. Low distortion and excellent isolation make it ideal for providing multiple outputs from atomic or crystal frequency standards. The 3 input channels will accept 10 MHz, 5 MHz, 1 MHz or 100 kHz in any combination. The number of outputs for each channel is selectable up to a total of 12 outputs. The output levels are individually adjustable from 0 to 3 V rms. All input and output levels are monitored on a front-panel meter.

The Distribution Amplifier features plug-in modular construction, short circuit isolation, exceptional phase stability, low noise and cross-talk, and uninterrupted switchover to standby dc in event of ac power failure.

The shielding around each input and output plug-in amplifier assures minimum noise and crosstalk. The tuned output amplifiers provide clean signals and high channel-to-channel isolation.

The instrument is designed for maximum versatility and can be supplied to meet a wide variety of special requirements. The standard configuration of input and output amplifiers is shown in Figure 1.

Several other commonly used configurations are also available and special combinations of the various input and output modules can be supplied. Input and output amplifiers can be added or the configuration easily changed at any time.

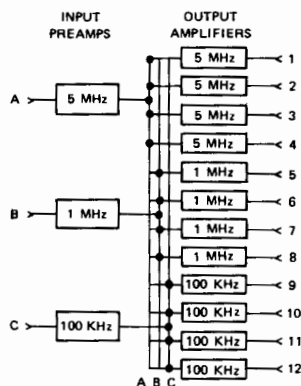

Figure 1. HP 5087A Distribution Amplifier with Option 031, Standard Configuration input and output amplifiers.

### Specifications

**Inputs:** (up to three, rear panel BNC).

**Frequencies:** 10 MHz, 5 MHz, 1 MHz or 100 kHz.

**Level:** 0.3 to 3.0 V rms, 50 ohms.

**Outputs** (up to 12 rear panel BNC).

**Frequencies:** 10 MHz, 5 MHz, 1 MHz or 100 kHz.

**Level:** 0–3 V into 50 ohms (screwdriver adjustment).

**Harmonic distortion:** >40 dB below rated output.

**Non-harmonic distortion:** >80 dB below rated output.

### Isolation

**Load** (open or short on any other channel)

**Amplitude change:** 0.1%.

**Phase change:** <0.1 ns at 5 or 10 MHz.

<0.5 ns at 1 MHz.

<5.0 ns at 100 kHz.

**Injected signal:** 1 V signal up to 50 MHz applied to any output except 10 MHz, will be down more than 60 dB in all other outputs; 10 MHz output channel will be down more than 50 dB.

**SSB phase noise (5 MHz):** >145 dB below signal in 1 Hz BW for frequencies > 1 kHz from carrier.

**Short term stability degradation (5 MHz):** <  $1 \times 10^{-12}$  in 10 kHz band. (1 s average).

### Environmental

**Temperature:** MIL-E-16400, Class 4.

**Operating:** 0–50°C; storage: –62° to +75°C.

### Stability

**Amplitude:** ±0.5 dB, 0° to 50°C.

**Phase:** <0.1 ns/°C., 5 and 10 MHz.

**Humidity:** 95% at 40°C.

**Altitude:** up to 30,000 ft.

### General

**Power:** 115 or 230 V ±10%, 48 to 440 Hz, 20 VA, max, or 22–30 V dc, 500 milliamperes, max.

**Dimensions:** 88 mm H x 425 mm W x 286 mm D (3.5 in. x 16.7 in. x 11.3 in.).

**Weight:** typical, Opt 031–Net 7 kg (15 lb).

### Ordering Information

HP 5087A Distribution Amplifier Mainframe \$2,600

**Normal Configurations** (input and output amplifiers)

Opt 031 5, 1 and 0.1 MHz inputs and 4 outputs at each frequency + \$2,600

Opt 032 Single 5 MHz input and 12 outputs + \$2,300

Opt 033 Single 10 MHz input and 12 outputs + \$2,300

Opt 034 Single 5 MHz input, 4 each outputs at 5, 1 and 0.1 MHz + \$2,700

### Special Configurations

**Input Preamplifiers** (up to 3 total)

Opt 004 Input Preamplifier (0.1 to 10 MHz) + \$120

Opt 005 5 to 1 MHz Input Divider + \$190

Opt 006 1 to 0.1 MHz Input Divider + \$290

Opt 011 5 to 10 MHz Input Doubler + \$290

Opt 013 10 to 5 MHz Input Divider + \$340

Opt 014 10 to 1 MHz Input Divider + \$340

**Output Amplifiers** (up to 12 total)

Opt 001 5 MHz Output Amplifier + \$190

Opt 002 1 MHz Output Amplifier + \$190

Opt 003 0.1 MHz Output Amplifier + \$220

Opt 012 10 MHz Output Amplifier + \$190

Opt 908 Rack Flange Kit + \$75



- 15 ampere-hour capacity
- Maintenance free lead-calcium batteries

- Used in "Flying Clocks"
- Automatic recharge

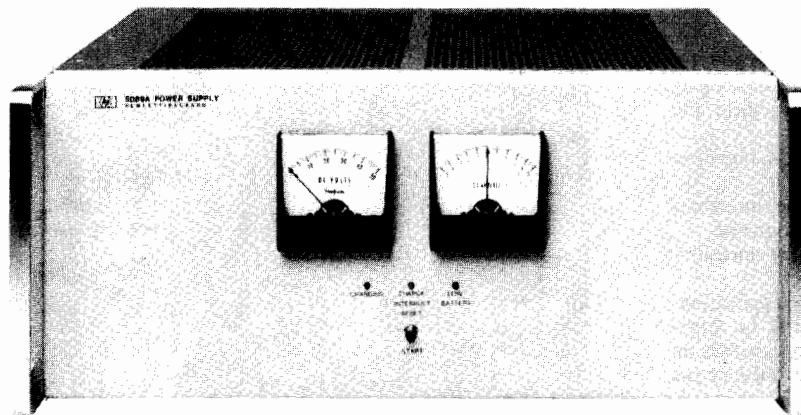

HP 5089A

### HP 5089A Standby Power Supply

The HP 5089A Standby Power Supply furnishes dc power to keep frequency or time standard systems operating during extended interruptions of ac line power. For applications where it is essential to maintain continuous operation and avoid loss of precise time, the use of a standby power supply is an absolute necessity. This unit is designed for use with Hewlett-Packard Cesium Beam Standards, Rubidium Vapor Standards, Quartz Standards, and other equipment which will operate from 22 to 28 V dc. No switching is used in transferring power from line to battery operation and back again, thus assuring uninterrupted operation.

#### Versatility

The HP 5089A is an extremely versatile unit. It was designed both as a portable power supply for the HP 5061B and HP 5065A "flying clocks", and as a standby supply for stationary applications.

#### Portable Applications

Portable or "flying clock" applications require a power supply to operate from a wide range of power sources, along with the standby capability to maintain continuous operation where no external power is available. A special inverter permits operation from a 12 V dc automobile battery. In addition, the 85 to 255 V ac, and 11 to 30 V dc capability enables the HP 5089A to operate from almost any power source in the world. The 15 ampere-hour standby batteries are the double sealed lead-calcium type, and thus are virtually spillproof. Mounting hardware is available to attach the HP 5089A to either the HP 5061B or the HP 5065A standards to make a portable frequency time standard package. These portable packages are available from Hewlett-Packard under HP E21-5061B and HP E21-5065A.

#### Stationary Applications

Stationary applications require long periods of power supply operation in a float or standby mode. Then, when an ac supply failure occurs, the supply must provide full standby capability. The charging circuits inside the HP 5089A are designed to charge the batteries in such a way that they will provide both long, trouble-free, reliable operation, and full standby power. After use, when ac power is restored, the HP 5089A will fully recharge its batteries. The double sealed batteries will not leak or require maintenance of any kind. Thus, the HP 5089A allows you to add standby capability to your system with very little increase in maintenance costs.

#### Ease of Operation

In normal operation there is virtually no required operator intervention. The HP 5089A automatically maintains the batteries in a fully charged state, ready to supply standby power. Should regular line power fail, the HP 5089A will provide uninterrupted dc power (to the limit of its standby capacity) for your equipment. After normal operating power is restored, the HP 5089A will automatically recharge its batteries back to the standby level.

The HP 5089A tells you its operational status at a glance through three LED lamps: GREEN indicates the battery is being charged; YELLOW indicates there has been an ac line failure; a RED lamp lights when the battery is almost fully discharged. Two front-panel meters show battery voltage and charge/discharge current.

#### Batteries

The HP 5089A utilizes the "immobilized electrolyte" technology in its maintenance-free lead-calcium batteries. The lead-calcium grid gives these batteries longer life with better reliability than conventionally designed batteries. The batteries are double sealed to provide virtually leakproof, and thus maintenance-free operation.

### HP 5089A Specifications

#### Input Voltage

**AC charging:** 85 V to 130 V ac rms, 48 to 440 Hz, 300 VA max.  
85 V to 255 V ac rms, 48 to 66 Hz, 300 VA max.

**DC operation:** 11 V to 30 V dc, 110 W max.

**Output voltage:** 22 V to 28 V dc (nominal). 2 A maximum.

**Standby capacity:** 15 AH at +25°C when fully charged.

**Recharge:** complete recharge in 24 hours when operating from ac line.

**External low battery voltage alarm:** floating contact closure at rear-panel barrier block for external visible or audible "low battery" warning. Contact rating is 30 V dc at 2 amperes.

#### Operating Environment

**Temperature:** 0°C to 50°C.

**Humidity:** up to 95% at 40°C (with no internal condensation).

**Altitude:** 12,000 metres (40,000 feet).

#### Storage Environment

**Temperature:** -40°C to +65°C.

**Humidity:** up to 95% noncondensing.

**Altitude:** 15,000 metres (50,000 feet).

**Dimensions:** 177 mmH x 425 mmW x 416 mmD (7 in. x 16.7 in. x 16.4 in).

**Weight:** net weight 30.5 kg (67 lb).

#### Accessories Supplied

HP 05061-6091: AC Power Input Cable Assembly  
HP 05089-60102: DC Power Input Cable Assembly  
HP 05089-60101: DC Output Cable Assembly  
HP 5060-0169: Extender Board Assy (Dual 25 Pin)

#### Ordering Information

	<b>Price</b>
<b>HP 5089A Standby Power Supply</b>	\$7,000
<b>Opt 001 Spare AI Board Assembly (HP 05089-60001)</b>	+\$1,000
<b>Opt 908 Rack Mounting Adapter Kit</b>	+\$75
<b>Opt 910 Extra Operating and Service Manual</b>	+\$90

# SEMICONDUCTOR TEST EQUIPMENT

## General Information

### Parametric Measurement

#### Semiconductor Parametric Measurement

Semiconductor parametric measurement instruments are used for measuring and evaluating the electrical characteristics of semiconductors.

Competition within the semiconductor field is fierce, and major goals are: developing new products rapidly, improving yield and reducing costs.

HP semiconductor parametric measurement instruments provide:

1. Precise, high-resolution measurements for accurate and reliable evaluation and
2. Automated operation from measurement through analysis.

Semiconductor measurement applications vary widely, from device R&D to large-volume manufacture on mass-production lines. Measurement equipment must fit the measurement functions required.

In R&D, parametric testers make comprehensive physical and electrical evaluations of new materials, prototype devices and evaluation test patterns. As the integration and performance of semiconductors advance, measurement instruments must have the expandability to adapt to the high resolution and precision demanded by new evaluation methods.

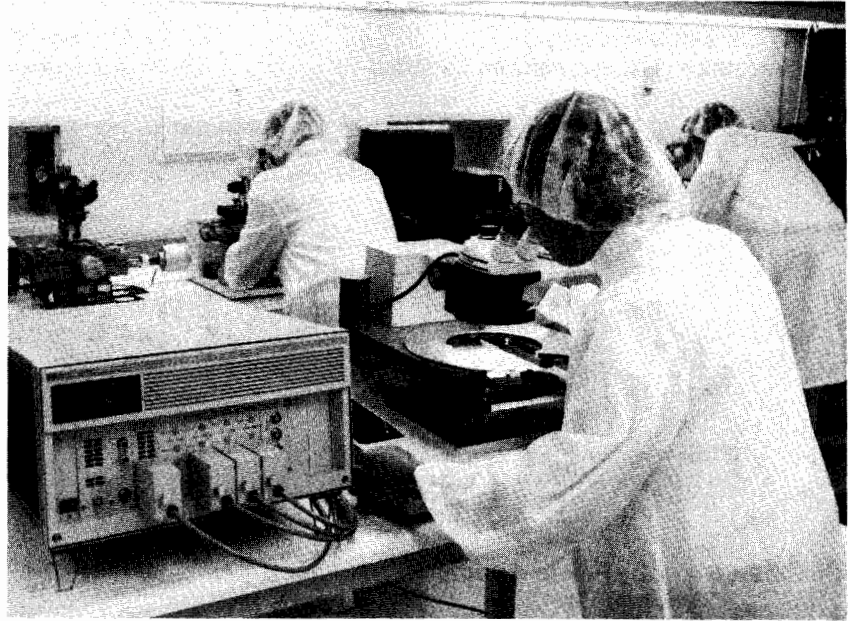

For production departments, parametric testing helps stabilize new processes for mass production and helps make process yield improvements. Functional testing is used mostly

in outgoing inspection. Cost reduction for both types of test requires high-speed, multiple-pin measurements and reduced down-time. The yield of new VLSI devices is less than 10 percent, and bad devices must be discarded. The accurate parametric testing provided by HP parametric testers can help improve processes and raise yields.

Parametric measurements are generally divided into capacitance (C) and dc, ac, and functional measurements. The following summarize each type of measurement.

1. Capacitance measurements include, primarily, capacitance vs voltage (C-V) and capacitance vs time (C-t). These capacitance measurements require correct measurement timing and good capacitance measurement resolution.

2. dc measurements measure the dc current vs voltage (I-V); dc parameter evaluation is based on I-V curve evaluation (for example, threshold voltage, breakdown voltage, leakage current). These measurements require high speed and resolution.

3. ac measurements evaluate the dynamic characteristics of the semiconductor device. With a digital IC, timing measurements such as rise time and propagation delay are the primary ones, so timing resolution is important. Determining the ac gain characteristics of linear ICs requires a wide dynamic range over a wide frequency band.

4. Functional testing evaluates the input/output operation and digital characteristics of semiconductor devices, especially logical devices. This measurement creates an input/output truth table and determines whether the desired output is attained or not.

Table 1 shows the parametric measurements required by each application area, with the HP parametric-measurement products that apply.

		Lab/R&D			Production		User
		Base Technology	Process Development	Circuit Design	Process Engineering	Testing/Quality Assurance	Incoming Inspection
C	C - V	●	●		●		
	C - t	●	●				
D	I - V	●	●	●	●		
C	Parameter	●	●	●	●	●	
AC Parameter				●		●	●
Functional				●		●	●
Instruments	C - V	HP 4274A					
		HP 4275A					
	I - V	HP 4284A					
		HP 4280A					
		HP 4140B					
I - V	HP 4141B						
	HP 4142B						
	HP 4145B						
Systems	I - V	HP 4145B & HP 4085M					
		HP 4061A					
	C - V	HP 4062B/C/UX					
		HP 82000 Model D200 Model D50 HP 9480					

Table 1. Measurements and HP instruments/systems by application area.

**Parameter Extraction & Circuit Device Modeling Integrated Software For Modeling And Test**

HP recently introduced HP 94000, a family of software products for characterization and parametric testing. The current list of applications includes IC-CAP and IC-MS. HP 94000 addresses the characterization needs of process engineers, modeling engineers and IC designers in a unified manner. IC-CAP and IC-MS are designed with features that make them attractive for both R&D and production environment.

**An Expandable Family of Software**

HP 94000 is a modular software family. IC-CAP and IC-MS are built around the same framework and adapt easily to your changing technical requirements.

**X-Window-based User Interface**

The powerful capabilities of HP 94000 software are enhanced by its X-window-based user interface. A single, consistent user interface for all applications eliminates the need to learn a new user interface for each application. HP 94000 is based on industry standards, HP-UX operating system and X-Windows and OSF/Motif. This combination offers standard networking capability as well as a consistent user interface.



HP 82000 IC Evaluation System

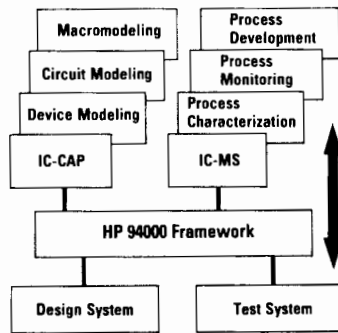

Growth path to address changing characterization requirements

**Digital IC Test**

The need for testing occurs several times during the development of digital IC's. First, prototypes encounter functional debugging and critical path analysis to prove what simulation predicted. Afterwards, in volume production, a series of tests is conducted to isolate defective parts. Devices failing as a result of a faulty manufacturing process are subject to thorough failure analysis. Results obtained can be used to optimize the process for an improved production yield. In addition to established quality control procedures at the manufacturer's site, customers can use test systems to analyze samples in incoming inspection and for vendor qualification.

**Application-specific ICs Create New Tester Demands**

A family of compatible products is available to address the requirements created by the growing number of application-specific ICs (ASICs). The different models cover the full range from mainstream CMOS to high-performance bipolar and GaAs ICs. All models provide functions for easy in-depth analysis of ICs, and they are optimized to switch quickly from one design to another.

**The HP 82000 IC Evaluation System**

The HP 82000 is a compact, fully integrated solution for ASIC prototype verification, IC characterization and low volume production test. IC manufacturers and ASIC users will appreciate the HP 82000's capabilities to reduce time-to-market in IC development. Automated tests combined with superior measurement performance, provide the resources to test high speed, high pin count devices quickly. Please see page 516 for details on this product.

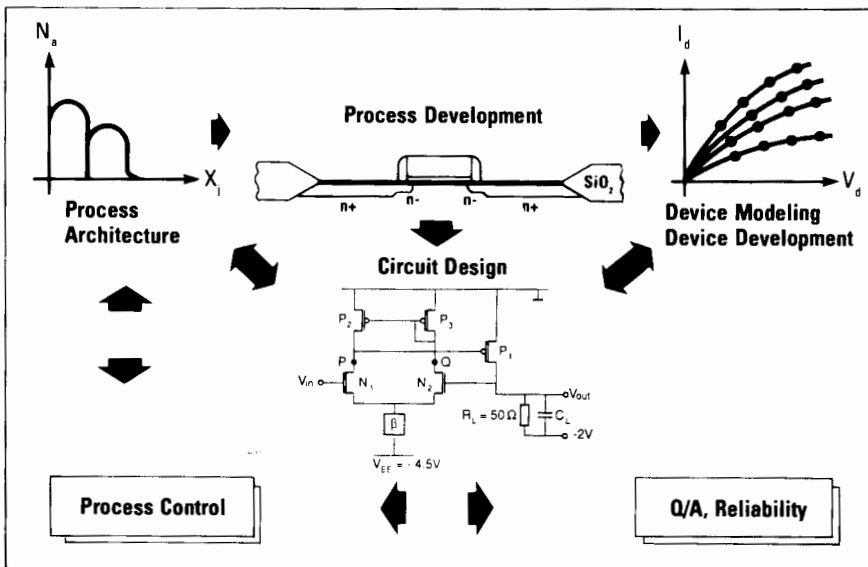

HP 94000 software applications improve productivity in characterization and testing during all phases of IC development.

# SEMICONDUCTOR TEST EQUIPMENT

## IC Evaluation System

HP 82000 Models D400, D200, D100, D50

- Up to 400 MHz vector rate
- Up to  $\pm 200$  ps edge placement accuracy
- Up to 768 channels
- Tester-per-pin architecture
- Automatic functional test generation
- Automatic ac/dc characterization

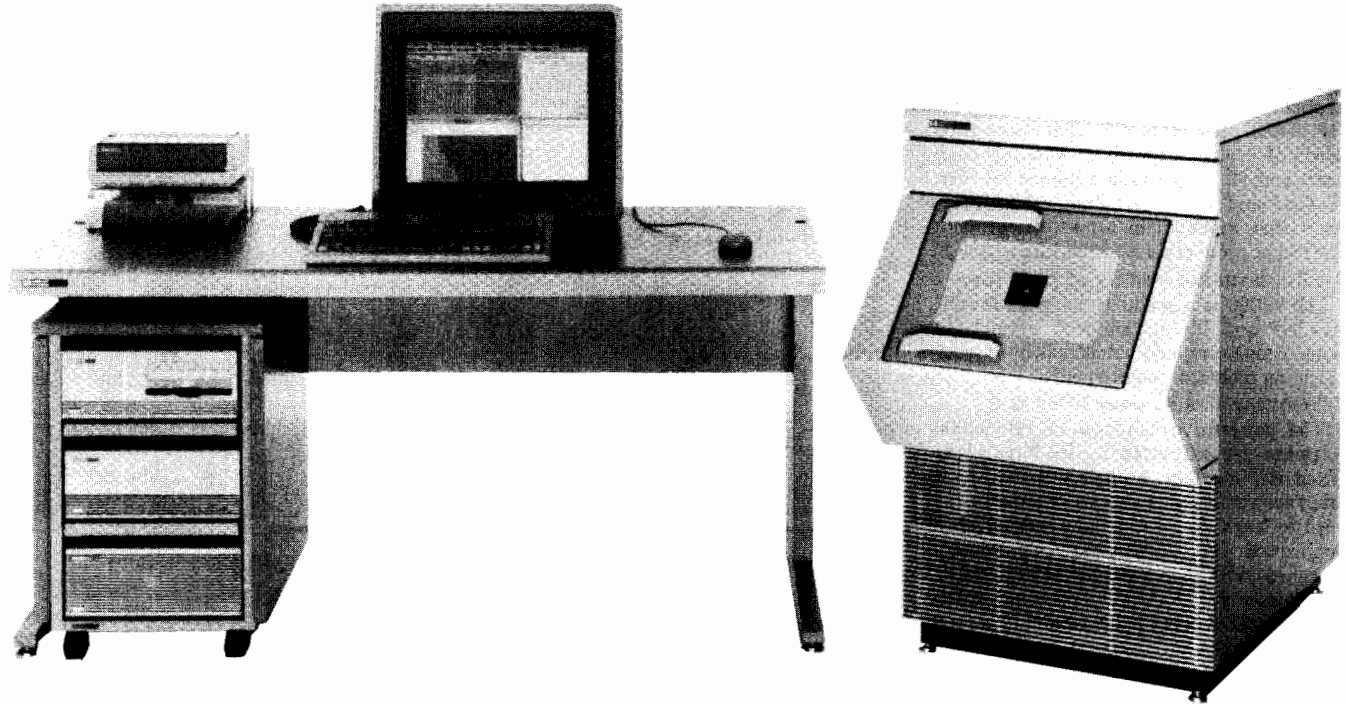

The HP 82000 standard frame configuration



### A Family of Compatible Systems

With the HP 82000, Hewlett-Packard offers systems to satisfy the IC evaluation requirements of both IC manufacturers and end users. To address a wide range of applications, four models are available: The HP 82000 model D400 for a maximum vector rate of 400MHz, and the models D200, D100, and D50 for maximum rates of 200MHz, 100MHz and 50MHz respectively.

#### Model D50

The HP 82000 model D50 is the ideal choice to test mainstream CMOS devices. ASICs with up to 768 bidirectional signal pins can be verified and characterized with up to  $\pm 500$  ps accuracy. Critical turn-around times are reduced with the automated characterization software, which is also compatible with the other models.

#### Model D100

The HP 82000 model D100 is designed to test BiCMOS and fast CMOS devices of up to 100 MHz. The edge placement accuracy is  $\pm 350$  ps on up to 512 I/O channels.

#### Model D200

The HP 82000 model D200 offers 200 MHz speed and  $\pm 250$  ps edge placement accuracy on up to 512 I/O channels. It is designed for manufacturers, design centers, and ASIC system designers with fast BiCMOS and bipolar devices.

#### Model D400

The HP 82000 Model D400 is intended for applications with the most demanding speed requirements. These are typically high-speed bipolar and GaAs devices. The D400 I/O boards can also be mixed and used with D200 boards, thus allowing great application flexibility.

### Application Examples

#### Prototype verification

Unlike large and complicated production ATE, the HP 82000 is a personal tester dedicated to your verification requirements. The ability to create a functional test program from the EDA (Electronic Design Automation) workstation database means faster time-to-market in prototype verification.

The earlier that design problems are detected, the lower the overall product development cost. This system enables you to analyze IC function and parameters at the prototype stage of the design cycle.

The risk of ASIC problems in later board level integration is minimized.

#### IC characterization

To optimize design throughput, Hewlett-Packard developed the automatic characterization functions as standard with every system. There are numerous test functions, which provide test patterns, the appropriate system setup, and automatically sweep test parameters for complete characterization tests. Measurements of ac and dc characteristics such as hold time or leakage current, are started quickly from menus and are completed instantly.

Engineering testing of prototype ICs is the main application area of the characterization functions. Other applications include Incoming Inspection and Failure Analysis of parts rejected by production ATE. For the latter, the HP 82000 can be used as a dedicated system to diagnose the process problems that caused rejection.

#### Production testing

For low-volume production testing, the HP 82000 can be a cost-effective solution because its high timing and level accuracies allow tight guardbands for higher test yield. Test programs can also be optimized for throughput by using HP-IB commands, and firmware-stored test setups. The high pincounts typically required in production testing are catered for by the maxiframe, which can house up to 512 D400, D200, or D100 channels, or 768 D50 channels (see picture on page 517). Third-party products can be integrated with the system to access wafer prober stations and device handlers. With systems in production and in the engineering department, test programs can be shared over a LAN (Local Area Network) without extra effort.

### Tester-per-pin Architecture Provides Best Accuracy and Flexibility

Timing and level capabilities are provided for every channel without sharing resources. Each channel also has dedicated memory for masking information, and can have its own data format (RZ, R1, DNRZ, and so on). All tester channels can be calibrated individually at the DUT pin. For best results, you can calibrate using the actual test parameter set—giving an edge placement accuracy of  $\pm 200$  ps for model D400,  $\pm 250$  ps for model D200,  $\pm 350$  ps for the model D100 and  $\pm 500$  ps for model D50. This is especially useful when performing fast go/no go tests, for example, in production.

**Best Time-to-test with Windows Software**

Productivity is increased with a highly interactive user interface based on the X Window standard. The mouse operated software is used to enter and modify parameters for pin timing and levels, and to modify the vector data. Thanks to the tester-per-pin architecture, parameters can be defined and changed for each channel individually without limitations through shared resources. Error map, timing diagram and shmoo plot displays show results in a graphic form familiar to the engineer. Simultaneous access to different windows lets you see immediately the results of changes made in the setup. "Change and see" avoids recompilation of test programs and gives you the shortest possible debug cycle.

**Automatic Test Program Generation**

The LAN provides fast access to design workstations from vendors such as Daisy, Mentor, Valid, HP and to FACTOR and VERILOG files. Other formats can be adapted by the user during the translation process or with the EDA programming toolkit. The computing power of a 32-bit workstation, and translation programs optimized for speed, maintain high throughput in the automatic test program generation.

Software fully supporting the testers' hardware resources, generates a functional device test without user programming. Test vectors, timing setup and pin setup are generated automatically.

**Test Control Includes Scan Path Testing**

To support "Design for testability", a scan path testing mode is integral to the system. The memory of up to 256 tester channels can be serialized via a software command, increasing vector depth on user-selected channels. A programmable vector sequencer has functions such as vector repeat, looping and branching on real time test results or external events.

**Minimum DUT Wiring**

"Instant wired" DUT boards for the popular pin layouts reduce the time for I/O wiring to zero and are available in various sizes to allow you to optimize board size and cost for the pin-count of your DUT. A controlled impedance environment from the testers' I/O circuits to the DUT provides excellent signal fidelity up to 400 MHz. To cover special IC packages, HP also offers boards that give maximum flexibility for user wiring.

**Cost-efficient Configurations**

For applications requiring a maximum of 80 I/O pins (160 I/O on the model D50), there is a compact benchtop alternative to the standard and maxiframe systems. The system components, including DUT boards, are compatible for upgrades to higher channel counts. With built-in self test and calibration, on-site board exchange is made easy. Expansion to maximum channel count systems with uncompromized speed and accuracy is possible by adding extra mainframes.

For Ordering and Technical Information, Technical data Sheets and Application Notes, please contact your nearest HP sales office.

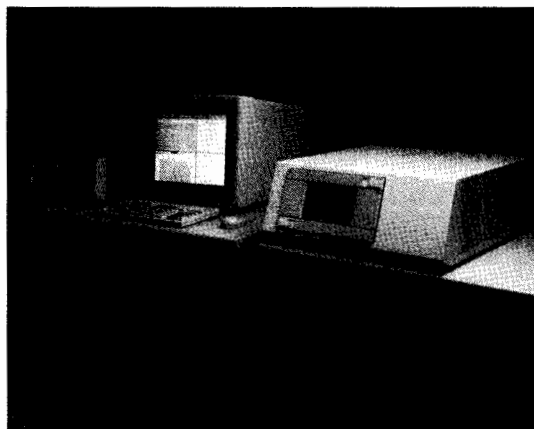
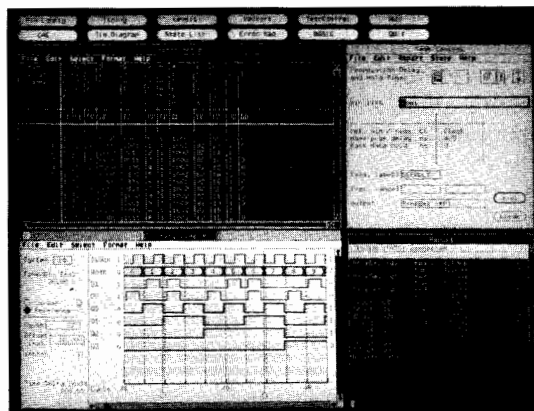

**HP 82000 System Characteristics**

	Model D400	Model D200	Model D100	Model D50
<b>Vector rate</b>	400 MHz	200 MHz	100 MHz	50 MHz
<b>Vector depth</b>	1024 K	512 K	256 K	256 K
<b>Max. I/O pin count</b>	512	512	512	768
<b>Timing resolution</b>	50 ps	50 ps	50 ps	100 ps
<b>Edge placement accuracy at</b>				
- standard calibration	±500 ps	±500 ps	±600 ps	±800 ps
- calibrated user settings	±200 ps	±250 ps	±350 ps	±500 ps
<b>Level range</b>	-4 .. +8V	-4 .. +8V	-4 .. +8V	-2 .. +7V
	-4 .. +5V (400 MHz RZ channels)			

**Architecture:** tester-per-pin with individual timing and level resources, including per-pin formatting, compare mode (edge/window), tristate, masking and channel modes.

**PMU's:** available as plug-in boards, one pair per mainframe.

**Software:** Interactive X Window environment, automatic tests and ac/dc characterization, color graphics result windows.

# SEMICONDUCTOR TEST EQUIPMENT

## Analog LSI Test System

HP 9480

- 128 MHz analog and digital synchronized testing
- 1 GHz bandwidth, 1 ps sampling resolution
- ac testing at the wafer level
- Digital signal processing (DSP) based system
- High test throughput modules
- Flexible modular architecture
- Powerful debugging tools
- Distributed workstation environment

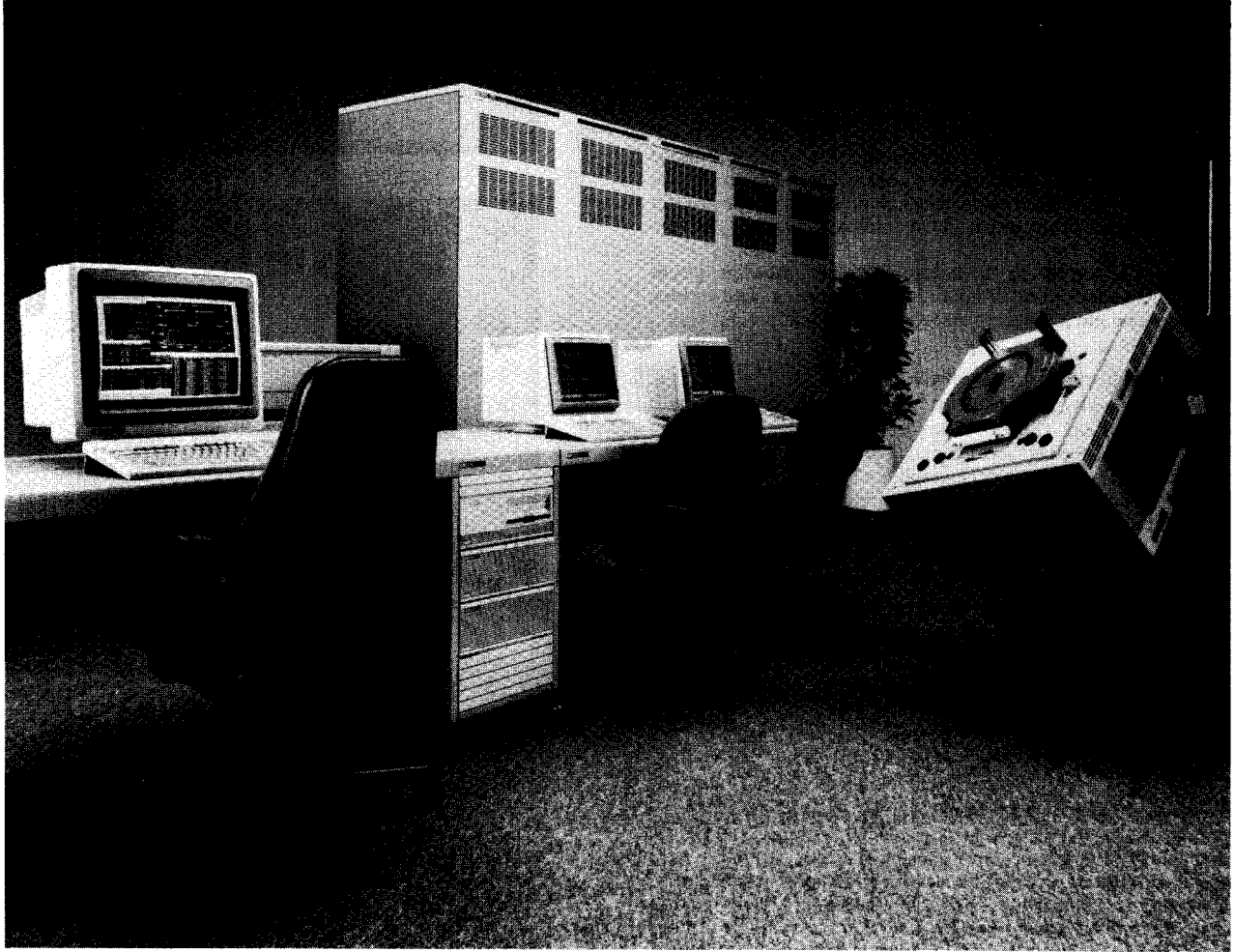

### HP 9480 Analog LSI Test System

The HP 9480 Analog LSI Test System integrates powerful test hardware and software to perform precise high frequency signal measurements. You can use the HP 9480 to test and characterize a wide variety of devices, from mixed signal devices such as flash ADCs, video DACs, telecommunication devices, etc., to purely analog or purely digital ICs. The HP 9480 provides full data sheet test coverage in a single insertion, thus eliminating the problem of time-consuming and costly multiple insertion testing. The HP 9480 can also perform high frequency AC tests on wafers.

The HP 9480s modular architecture allows you to combine many state-of-the-art hardware and software features into a configuration that best suits your measurement needs. The system can generate digital stimulus patterns and analog stimulus waveforms up to 128 MHz, and can capture DUT digital response patterns up to 128 MHz. For

analog DUT response, the system offers 16 and 12-bit real time waveform digitizers and 1 GHz bandwidth samplers with 1 ps resolution. The system also offers 18/12/10 bit arbitrary waveform generators. Digital patterns, dc voltage, and dc current can be input or output to up to 128 pins. Analog signals can be input or output using up to 4 channels each. Digital Signal Processing (DSP) allows complex waveform generation and high speed signal analysis via a full floating point array processor. The HP 9480s system software is based on the HP-UX operating system. Powerful debugging tools, including an off-line debugger, virtual panel, and virtual scope, significantly minimize debugging time. Further, HP 9480 software is easy to operate because it incorporates menus, a user-friendly multi-window environment, and mouse capability. These features increase test throughput and minimize time spent on program development.

## Hardware

### Device Testing Under In-circuit Conditions

The HP 9480's analog and digital signal test capability enables you to test the dynamic parameters of devices under their true operating conditions. The HP 9480 can also perform high frequency tests on wafers because of its coaxial cable environment and very low system noise.

For ac signal stimulus, the HP 9480 generates low distortion sine waves (up to 128 MHz), arbitrary waveforms with 12-bit resolution (up to 128 MHz clock rate), and arbitrary waveforms with 18-bit resolution (up to 1 MHz clock rate). For recording high frequency signals up to 1 GHz, with 12 bit resolution, the system offers 4 sampler channels that sample a signal with 1 ps resolution. For recording signals in real time, the system offers two choices—20 MHz/12-bit and 1 MHz/16-bit digitizers. For digital testing, the system offers up to 128 I/O pins, and features 64 kword memory for each pin. The system can generate digital stimulus patterns and clocks, and can analyze response patterns from the test device at a data rate of 128 Mwords/s with 100 ps resolution. And because the HP 9480 can synchronize analog waveforms with digital signals, and can automatically execute timing adjustments, you can perform precise tests on mixed signal devices under actual operating conditions.

### Digital Signal Processing (DSP) Technology

The HP 9480 uses digital signal processing to generate and analyze analog and digital signals.

For example, you can easily and quickly modify and create waveforms in the frequency domain by using FFT commands. The HP 9480 can easily synchronize analog signals with system clocks because the waveform data is recorded into system memory. Multiple parameters such as THD, SNR, differential nonlinearity, etc., can be extracted from the recorded data without running the test again. A 32-bit full floating point array processor minimizes system controller loading by performing complex matrix computations for digital signal processing. DSP technology shortens test times by allowing multiple parameter extraction from a single test, and minimizes hardware costs because analog and digital processing are performed by the same modules.

### Modular Architecture

The modular system architecture of the HP 9480 allows easy adaptability to your changing test needs. This means that the system's usefulness and value are maintained well into the future, because system upgrades and enhancements are easy and cost-effective. Also, maintenance costs are minimized because only faulty modules need to be repaired or replaced in the event of a system malfunction.

### High Test Throughput

In addition to the high speed testing resources, the dual test head system contributes to increased test throughput. For an ADC characteristic test, the Histogram Accelerator is available to reduce the test time by a factor of 60.

### Software

HP 9480 software is based on the HP-UX operating system, and operates on HP 9000 Series 300 engineering work stations. HP-UX is fully compatible with standard UNIX systems, and incorporates an advanced multi-window system with a mouse and pop-up menus. This provides graphics oriented test development, testing, and data analysis environments, which facilitate smooth and efficient operation. You

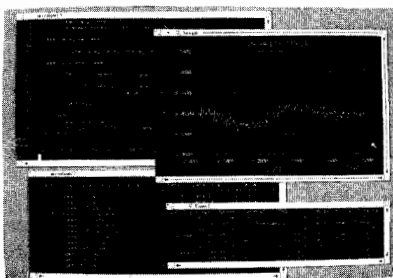

Multi-window Environment

can easily set up conditions and values for test execution and data analysis, with the HP 9480s fill-in-the-blanks format. You simply enter the appropriate information into the mask fields displayed on the screen.

### Test Development

The HP 9480 features two debugging modes and three useful tools for you to use the test hardware effectively, and reduce the amount of time spent on test program development.

The debugging modes available are off-line and the standard on-line debugging. A hardware simulator is used with off-line debugging. Therefore, off-line debugging and device test execution can be performed at the same time because the test hardware is not used for off-line debugging. This guarantees efficient system utilization.

Available tools are the symbolic debugger, virtual panel, and virtual scope. The symbolic debugger offers a number of features that enable the user to debug at the source code level. The symbolic debugger decreases debugging time because it allows you to modify test conditions without program recompilation. The virtual panel displays the hardware settings and output conditions in real time when debugging, thereby allowing you to confirm program measurement conditions. The multi-window function displays hardware information on a module-by-module basis. The virtual scope displays the stimulus waveform or pattern data specified in the program, and the response waveform output from the test device. These tools minimize the test development time and maximize engineering productivity.

### Testing

The HP 9480 provides easy operation in the test execution environment. The test conditions are set in a fill-in-the-blanks format displayed on the screen, and tests start by the press of a function key or the start button on the operator console. The operator console is a compact terminal to control test execution, such as test start, re-test, and test stop.

For monitoring tests quickly, the virtual scope and summary logging are useful tools. The virtual scope displays waveform output from the test device. The summary logging collects data during device testing, and makes test summary, bin summary, and lot summary reports.

### Data Analysis

The HP 9480s software capabilities are complemented by a comprehensive set of data analysis functions. These functions allow you to make effective use of all test data collected during device testing. The following reports can be set up and displayed so that you can easily analyze measurement results: tabular reports, scatter diagrams, control charts, wafer maps, X-Y graphs, Shmoo plots, and bar charts.

### Tester Workstations (sold separately)

The HP 9000 Series 300 computer, the HP 9480 system controller, can connect directly to the Ethernet/IEEE802.3 local area network (LAN).

When networked, HP 9480 tasks can be distributed between workstations in the network. This increases system efficiency because tasks previously managed by one computer are now distributed between workstations. For example, you can use a test development station (TDS) as a stand-alone workstation for test program development, such as editing, compiling, and off-line debugging, while testing, without degradation of test performance.

### Application Support for Rapid Start Up

HP Semiconductor System Centers (SSCs) offer quality application support for quick start up of your HP 9480 system. Application support packages include consultation with expert HP personnel, and the tailoring of test program software and hardware to your specific test requirements.

### System Specification Summary

**128 pin I/O, 128 MHz (1  $\mu$ Hz resolution) clock rates**

#### Analog signals analysis

16 bit (1MHz)/12 bit (20MHz) real time digitizer

1GHz (12 bit) high frequency sampler

#### ac signal stimulus

18 bit (1MHz)/12 bit (128MHz)/10 bit (128MHz) AWG

#### Digital test

64K word (128MHz) WG/WM

DC test per pin

# SEMICONDUCTOR TEST EQUIPMENT

## Process Control System

### HP 4062UX

- High speed and wide measurement range
- Standard Networking
- Interactive Measurement and Analysis

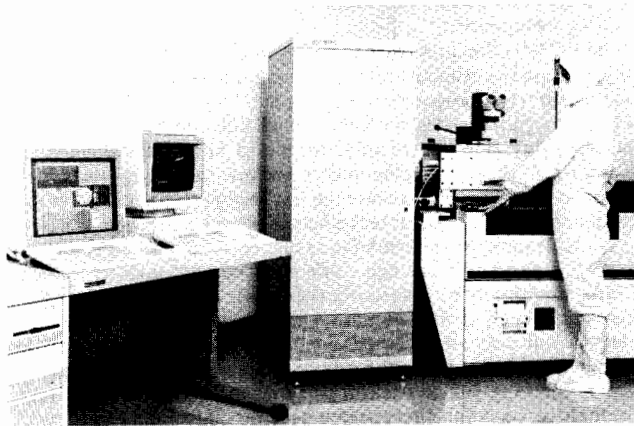

### HP 4062UX Semiconductor Process Control System

The HP 4062UX Semiconductor Process Control System is the high-end system of the HP 4062 Semiconductor Parametric Test System family. The HP 4062UX satisfies all of the requirements of the Integrated Circuit Manufacturers for both process monitoring and process development. Since the HP 4062UX uses the same measurement hardware as the HP 4062C, it maintains the same highly accurate and reliable measurement capabilities as the HP 4062C, such as high speed measurements over a wide measurement range. For example, a typical connect-connect-force-measure sequence (resistance) measurement takes less than 17 ms, and measurements can range from 20 fA to 1A and 4  $\mu$ V to 200V. Refer to the HP 4062C description on page 522 for more information about the high-speed measurements and wide measurement range that are also possible with the HP 4062UX.

In addition to the sophisticated hardware of the HP 4062C, the HP 4062UX provides powerful software capabilities with the HP BASIC/UX operating environment. HP BASIC/UX combines the most powerful instrument control language, HP BASIC, with all the elements of HP-UX, the Hewlett-Packard implementation of the AT&T System V UNIX\* operating system. HP Interactive Measurement and Analysis (IMA) Software makes measurements interactively by providing a soft panel user interface.

### Networking

You can easily link the HP 4062UX to other test systems or computers over standard Local Area Networks (LANs). Access to IEEE 802.3/Ethernet using ARPA/Berkeley services, to DECnet using NS/VAX, or to SNA using a SNA gateway is easily accomplished with the HP 4062UX. The HP 4062UX system controller can be integrated into test-area or factory-level management systems. A diskless cluster configuration allows for the sharing of file storage disks and printing peripherals, resulting in low-cost test-area design.

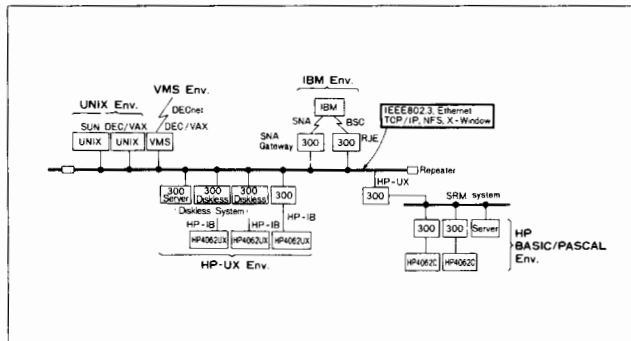

\* UNIX is a U.S. registered trademark of AT&T in the U.S.A. and in other countries.

- Multiuser and multimask
- Multiwindow
- Offline debugger

### Multitasking and Windowing

The HP BASIC/UX environment brings multitasking and windowing to process control. While a test is running in one window, you can analyze measurement data in another window. Or use the Virtual Front Panel (VFP) in one window to monitor tests running in a second window. These features increase productivity and efficiency.

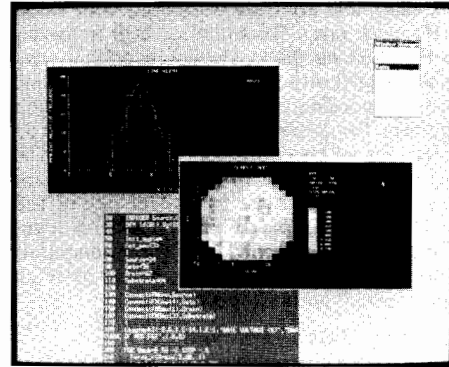

### Interactive Measurement and Analysis

HP Interactive Measurement and Analysis (IMA) software turns the HP 4062UX into an automatic semiconductor analyzer. You can make measurements without having to program by an interactive, softpanel user interface.

### Off-line Debugger

The HP 4062UX contains a unique offline debugger that lets you write and debug test programs without having to access the measurement hardware. With the multitasking capability, you can create test programs at the same time that you are testing wafers.

### Full HP-UX Access

HP BASIC/UX can directly access any HP-UX command. This capability offers you the use of all the powerful tools available for HP-UX, such as the Source Code Control System (SCCS). A full spectrum of HP-UX applications is available, such as:

- Database management systems (Oracle, HP-SQL/300, etc.)
- Data analysis packages (RS/1, SAS, etc.)
- Computer-aided design software

All this power is available on the same computer that controls the HP 4062UX Semiconductor Process Control System.

### Specifications

**Measurement functions:** I, V, I-V, C-G-V, C-G-t, Pulse I/V, Pulse I-V, Analog Search

**Switching matrix - Number of pins (to DUT):**

12 pins to 48 pins (48-pin matrix)

24 pins to 96 pins (96-pin matrix)

**Number of ports (to instrument):** 9 ports

High resolution source/monitor unit: 1 port

High power source/monitor unit: 1 port

Source/monitor units: 2 ports

Ground unit: 1 port

Auxiliary: 4 ports (for V sources/V monitors and C meter)

**Maximum voltage at each port:**  $\pm 200$ V (SMU ports)

$\pm 100$ V (aux. ports)

**Maximum current through ports to pins:**  $\pm 1.6$ A (GNDU port)

$\pm 1$ A (SMU ports)

**DC source/monitor units (SMUs)**

SMU for high resolution port: 1 unit

V:  $\pm 40 \mu$ V to  $\pm 100$ V

I:  $\pm 20$  fA to  $\pm 100$  mA

Basic accuracy:  $\pm 0.05\%$

Basic accuracy:  $\pm 0.2\%$

SMU for high current port

V:  $\pm 40 \mu$ V to  $\pm 200$ V

I:  $\pm 2$  pA to  $\pm 1$ A

Basic accuracy:  $\pm 0.05\%$

Basic accuracy:  $\pm 0.2\%$

SMUs: 2 units - Kelvin

V:  $\pm 40 \mu$ V to  $\pm 100$ V

I:  $\pm 2$  pA to  $\pm 100$  mA

Basic accuracy:  $\pm 0.05\%$

Basic accuracy:  $\pm 0.2\%$



\*V force resolution is 100  $\mu$ V, I force resolution is 50fA (high res SMU) and 5pA (other SMUs)

Ground unit (GNDU): 1 unit

$\pm 1.6$ A Accuracy:  $\pm 1$ mV

Voltage sources (VSs): 2 units  
 $\pm 1$  mV to  $\pm 40$ V

Basic Accuracy:  $\pm 0.1\%$

Voltage monitors (VMs): 2 units  
 $\pm 40$   $\mu$ V to  $\pm 40$ V

Basic Accuracy:  $\pm 0.05\%$

\*Differential voltage can be measured with 4 $\mu$ V resolution

All SMUs can function as a dc voltage source/current monitor or current source/voltage monitor. Pulse measurements can be made with SMUs and VSs.

#### Capacitance-Conductance Measurements

##### HP 4280A

Test frequency: 1 MHz,  $\pm 0.01\%$

OSC level: 30 mVrms  $\pm 10\%$ , and 10 mVrms  $\pm 10\%$

Measurement range: (maximum resolution to full scale)

C: 0.001 pF to 1.2 nF Basic accuracy:  $\pm 0.5\%$

G: 0.01  $\mu$ S to 12 mS Basic accuracy:  $\pm 1.5\%$

DC bias voltage: (for capacitance measurements)  $\pm 100$ V

##### HP 4284A

Test frequency: 1k, 10k, 100k, 1 MHz  $\pm 0.01\%$

OSC level: 30 mVrms  $\pm 10\%$

Measurement range:

C: 0.001 pF to 1.2 nF G: 0.01  $\mu$ S to 12 mS (at 1 MHz)

C: 0.001 pF to 10 nF G: 0.01  $\mu$ S to 100 mS (at 100 kHz)

C: 0.001 pF to 100 nF G: 0.01  $\mu$ S to 1000 mS (at 10 kHz)

C: 0.01 pF to 100 nF G: 0.1  $\mu$ S to 1000 mS (at 1 kHz)

dc bias voltage for capacitance measurements:  $\pm 40$ V (optional)

#### System controller

Supported controller: HP 9000 series 300 Model 320, 330, 332, 350, 360, or 370. HP 9000 series 300 Model 318M, 319C+ and 340 are supported as a diskless cluster node.

Required main memory: 4 Mbyte

Recommend: 8 Mbyte

Required hard disk memory:

Test execution environment: 150 Mbyte with 15 Mbyte swap

Test execution and development environment: 300 Mbyte with 20 Mbyte swap

Required HP-HIL Device: HP 46084A ID module

#### Software

Operating system: HP-UX 7.0

Programming language: HP BASIC/UX 5.52

Programming utilities: TIS (test instruction set)

PARA (parameter extraction)

PPG (probing pattern generator)

PCL (prober control library)

Offline debugging: TIS for offline debugging

VFP (virtual front panel)

Data processing: FCL (file creation library)

XYGRAPH (XY graphics)

MAP (wafer map)

Basic statistics and data management

Interactive Measurement and Analysis (IMA) Software

Available networking: NS, ARPA, Berkeley, NFS, SNA

#### Prober interface

Automatic wafer probers used with the HP 4062UX must be equipped with HP-IB capability. Hardware for mounting the switching matrix on the prober is also required. Contact the prober manufacturer for details concerning necessary mounting hardware. Control software for Electrogras 1034X/2001X and TSK APM6000/7000 probers is furnished.

#### Reference Data (typical)

##### Command execution time

Connect (relays): 4 ms

dc source/monitor<sup>1</sup>: Force (current or voltage): 4 ms

Measure (current or voltage): 5 ms

Analog search<sup>2</sup>: 25 ms

<sup>1</sup>When integration time is short and range is not 1 nA/10 nA. Excludes wait time set by user.

<sup>2</sup>Analog search controls the output of one SMU to set the output of another to a given value.

#### General specifications

Operating temperature: 5°C to 40°C, 55% to 70% RH

Permissible temperature change:  $\leq 3^\circ$ C after calibration

Air cleanliness: class 100,000 or higher clean room required

Power requirements: 100V (90V to 110V), 120V (108V to 127V),  
220V (198V to 242V), 240V (216V to 252V), 48 Hz to 66 Hz, 1150 VA maximum

#### Size

Cabinet: 1600H x 600W x 800mm D

48-pin matrix: 210H x 406W x 380mm D

96-pin matrix: 250H x 620W x 600mm D

#### Weight

Cabinet with instruments: approx. 230kg

48-pin matrix: approx. 22kg (48 pin config.)

96-pin matrix: approx. 55kg (96 pin config.)

HP 4142B power limitation: 32W

#### Ordering Information

HP 4062UX Semiconductor Process Control System \$33,400

(consists of system cabinet, a license to use the HP 4062UX software, system documentation library, and software installations of HP-UX, HP BASIC/UX and HP 4062UX)

Opt 022 1/4-inch tape media +\$3,600

Opt 050 50Hz power line frequency \$0

Opt 060 60Hz power line frequency \$0

#### 48-pin matrix options

Opt 310 Add HP 4085B 48-pin matrix with 12 pins (and HP 4085B/16066A/16075A/16076A) +\$24,900

Opt 311 Add 1 pin (HP 16320B) to HP 4085B +\$600

Opt 312 Add test fixtures for packaged devices (Add HP 16067A through HP 16070A) +\$3,100

Opt 313 Add HP 16077A extension cable fixture +\$1,300

Opt 314 Add HP 16071A universal fixture +\$385

Opt 315 Add HP 16071B universal fixture (kelvin) +\$430

Opt 316 Add HP 16072A personality board (for use with probers other than Electrogras) +\$214

Opt 317 Add HP 16072A with Opt. 001 (for use with Electrogras 1034X/2001X) +\$214

Opt 318 Add HP 16072B personality board (kelvin) (for use with probers other than Electrogras) +\$240

Opt 319 Add HP 16072B with Opt. 001 (kelvin) (for use with Electrogras 1034X/2001X) +\$240

#### 96-pin matrix options

Opt 330 Add HP 4089A 96-pin matrix with 24 pins (Add HP 4089A/16370A/16355A/16356A) +\$53,900

Opt 331 Add 1 pin (HP 16320C) to HP 4089A +\$640

Opt 332 Add test fixtures for packaged devices (Add HP 16371A through 16375A) +\$6,600

Opt 333 Add HP 16378B extension cable fixture +\$4,200

Opt 334 Add HP 16376A universal fixture +\$510

Opt 335 Add HP 16376B universal fixture (kelvin) +\$510

Opt 336 Add HP 16377A personality board +\$520

Opt 337 Add HP 16377B personality board (kelvin) +\$520

#### Measuring instruments

Opt 400 Add HP 4142B modular DC source/monitor +\$14,900

Opt 405 Field installation kit for HP 4142B +\$3,900

Opt 410 Add HP 41420A 200V/1A SMU +\$4,300

Opt 411 Add HP 41421B 100V/100mA SMU +\$3,540

Opt 414 Add HP 41424A VS/VM unit +\$3,220

Opt 415 Add HP 41425A analog feedback unit +\$1,720

Opt 450 Add HP IMA Software Package \$5,400

Opt 451 Add HP IMA License-To-Use \$4,600

Opt 510 Add HP 4280A 1 MHz C meter +\$13,800

Opt 515 Field installation kit for HP 4280A +\$2,800

Opt 520 Add HP 4274A LCR meter (100 Hz-100 kHz) +\$12,900

Opt 521 Add  $\pm 35$ V bias (Opt. 001-4274A) +\$890

Opt 522 Add  $\pm 100$ V bias (Opt. 002-4274A) +\$830

Opt 525 Field installation kit for HP 4274A +\$3,000

Opt 530 Add HP 4284A LCR Meter +\$13,700

Opt 531 Add 40V bias (Opt. 001-4284A) +\$1,150

Opt 535 Field installation kit for HP 4284A +\$3,800

# SEMICONDUCTOR TEST EQUIPMENT

## Semiconductor Parametric Test System

### HP 4062C

- 25 ms Vth/hFE Extraction (typical)
- $\pm 20$  fA to  $\pm 1$ A precise wafer measurements



HP 4062C



(System controller, printer and tables are sold separately.)

### HP 4062C Semiconductor Parametric Test System

The HP 4062C Semiconductor Parametric Test System is a high throughput, high resolution computer-controlled system for measuring the dc voltage and current, and 1MHz capacitance and conductance parameters of wafer-state devices, as well as discrete and packaged devices. Based on its predecessor, the HP 4062B, this enhanced system will enable you to significantly improve IC yield and quality, and increase efficiency during new process development.

Precise 20fA, 4 $\mu$ V, and 1fF measurements to  $\pm 200$ V and  $\pm 1$ A are possible through the 4062C's low-noise, reliable switching matrix, which you can configure with up to 96 DUT pins. And specifications are guaranteed at all DUT pins. The heart of the HP 4062C, the high speed HP 4142B Modular DC Source/Monitor, provides fast throughput over a wide measurement range—without sacrificing resolution—for wafer process monitoring and evaluation. Highly reliable wafer measurement results can quickly be fed back to design and process engineers to improve your IC yield and quality.

The HP 4062C's language system is the simple, yet powerful, HP BASIC. Parameter measurements, such as threshold voltage and current gain, can be performed with a simple two-line program thanks to the HP 4062C's measurement utility subprograms. In addition, HP Interactive Measurement and Analysis (IMA) makes the measurements interactively, using the HP 4062C.

### High Speed Measurements, Wide Measurement Range

In production environments where measurement speed is prerequisite, the HP 4062C comes through. The HP 4062C's DC measurement subsystem provides high speed device/process parameter extractions, while maintaining measurement resolutions down to 20fA and 4 $\mu$ V. For example, by using the DC measurement subsystem's Analog Feedback Unit (AFU), such key device parameters as threshold voltage (Vth) and forward current gain (hFE) can be obtained in as little as 25ms: roughly 4 times faster than the HP 4062B.

The HP 4062C's switching matrix subsystem enables reliable measurement results by virtually eliminating the effects of environmental noise, while minimizing leakage current and stray capacitance. Also, the HP 4062C's expanded measurement range of  $\pm 20$ fA to  $\pm 1$ A and  $\pm 4$  $\mu$ V to  $\pm 200$ V is guaranteed to the tip of each switching matrix DUT pin. This exacting performance ensures precise, reliable semiconductor parameter measurements through the switching matrix for each system instrument.

### Easy To Program

The HP 4062C's Test Instruction Set (TIS) software makes programming easy, and the fast execution of TIS programs ensures high speed measurements. By using the furnished measurement library, you can quickly create and execute programs. For example, to perform a Vth or hFE measurement requires only one or two program lines.

### Specifications

#### Hardware

Same as HP 4062UX

#### Software

**Operating system:** HP BASIC 5.1 or later

**Programming language:** HP BASIC

#### Programming utilities:

TIS (test instruction set)

PARA (parameter extraction)

PPG (probing pattern generator)

PCL (prober control library)

#### Data processing:

FCL (file creation library)

XYGRAPH (XY graphics)

Basic statistics and data manipulation

#### HP Interactive Measurement and Analysis (IMA) Software

##### System controller

**Supported controller:** HP 9000 Series 300 Model 310, 320, 330, 332, 350, 360 and 370

**Required main memory:** 2 Mbyte

**Required HP-HIL device:** HP 46084A ID module

**Required interface:** in addition to internal HP-IB I/O, 2 extra HP-IB I/O's (98624A) are required.

### Ordering Information

**HP 4062C Semiconductor Parametric Test System** \$127,900  
(consists of HP 4142B modular DC source/monitor, 48-pin matrix with 48 pins, HP 4280A 1MHz C meter, system cabinet, system software, system library and system software installation.)

**Opt 050/060** for 50/60 Hz line frequency \$0

**Opt 100/120/220/240** for 100/120/220/240V Line voltage \$0

**Opt 001** 12 pin configuration of 48 pin matrix -\$21,600

**Opt 002** 24 pin configuration of 48 pin matrix -\$14,400

**Opt 003** 36 pin configuration of 48 pin matrix -\$7,200

**Opt 004** Add spare pin board of 48 pin matrix +\$600

**Opt 012** 24 pin configuration of 96 pin matrix +\$11,700

**Opt 013** 36 pin configuration of 96 pin matrix +\$19,300

**Opt 014** 48 pin configuration of 96 pin matrix +\$26,900

**Opt 015** 64 pin configuration of 96 pin matrix +\$37,000

**Opt 016** 72 pin configuration of 96 pin matrix +\$42,100

**Opt 017** 84 pin configuration of 96 pin matrix +\$49,800

**Opt 018** 96 pin configuration of 96 pin matrix +\$57,500

**Opt 019** Add spare pin board of 96 pin matrix +\$640

**Opt 020** Replace HP 41420A with HP 41421B -\$750

**Opt 021** Add spare HP 41421B SMU (100V/100mA) +\$3,540

**Opt 022** Add spare HP 41420A SMU (200V/1A) +\$4,300

**Opt 023** Add spare HP 41424A Vs/Vm +\$3,220

**Opt 024** Delete one HP 41421B SMU (100V/100mA) -\$3,540

**Opt 025** Delete one HP 41420A SMU (200V/1A) -\$4,300

**Opt 026** Delete one HP 41424A Vs/Vm -\$3,220

**Opt 027** Delete one HP 41425A AFU -\$1,720

**Opt 102** Delete HP 4280A -\$11,100

**Opt 110** Delete Package Fixtures for 48 pin Matrix -\$4,190

**Opt 115** Delete Package Fixtures for 96 pin Matrix -\$7,100

**Opt 130** Delete System Rack -\$3,600

**Opt 310** Add HP 4274A +\$12,900

**Opt 311**  $\pm 35$ V Internal DC Bias for HP 4274A +\$890

**Opt 312**  $\pm 100$ V Internal DC Bias for HP 4274A +\$830

**Opt 320** Add HP 4284A +\$13,700

**Opt 321**  $\pm 40$ V Internal DC Bias for HP 4284A +\$1,150

**Opt 405** HP 4062C's System Software Right-To-Copy -\$2,250

**Opt 450** Add HP IMA Software Package +\$4,200

**Opt 451** Add HP IMA Licence-To-Use +\$3,600

**Opt 503** Personality Board for Electroglas Probers \$0

**Opt 910** Extra System Library +\$320

# SEMICONDUCTOR TEST EQUIPMENT

## Semiconductor Parametric Test System

HP 4062B

523

- Precise, high speed probed wafer measurements
- 1pA resolution at all 48 pins

- Easy to program with Probing Pattern Generator
- Virtual front panel simplifies operation

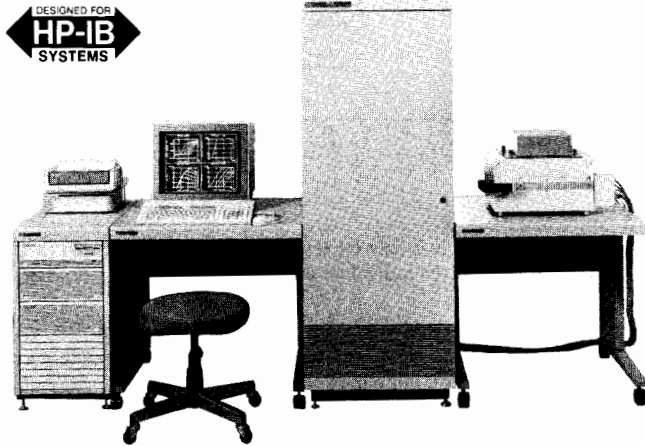

HP 4062B  
(System controller, printer and tables are sold separately.)

### Description

The HP 4062B Semiconductor Parametric Test System will help you improve IC yield and quality in production plus increase engineering efficiency. The system measures DC voltage/current and 1 MHz capacitance/conductance of wafers with high resolution and speed.

Precise 1pA and 1fF measurements are performed using a low noise switching matrix with up to 48 DUT pins. All specifications are guaranteed on these DUT pins. High speed measurement units provide fast throughput of high resolution measurements for wafer process monitoring and evaluation. Highly reliable measurements performed on wafers can be fed back to design and process engineers to improve your IC yield and quality.

The HP 4062B is programmed with the simple and powerful HP BASIC. Parameter measurements such as threshold voltage or current gain can be made by a two line program using the HP 4062B's measurement utility subprograms. Prober control software is supplied to allow users to easily operate a wafer prober with the HP 4062B. The system software features an extensive program library that includes statistical analysis, trend charts, and the Virtual Front Panel (VFP) for convenient manual measurement. The HP 4062B will help you reduce software development time and increase engineering efficiency with easy programming.

### Software Library

Virtual Front Panel (VFP)  
Test Instruction Set (TIS)  
Graphics Library  
Parameter Measurement Library  
Auto Prober Control Library  
Data Processing Library  
Diagnostic Program

### System Configuration

DC Source/Monitor (HP 4141B)  
Switching Matrix (48-pin configuration)  
Switching Matrix Controller  
1 MHz C Meter/C-V Plotter (HP 4280A)  
Rack Cabinet

### Specifications

#### Switching Matrix

**Number of pins (to DUT):** 48 pins (standard) with options for 12, 24 and 36 pins.

**Number of ports (to instrument):** 9 ports

### DC Source and Monitor Units

**High resolution source and monitor unit (SMU1):** 1 unit  
**Output/Measurement Range:** Current,  $\pm 1\text{pA} - \pm 100\text{mA}$ , Basic Accuracy, 0.3%; Voltage,  $\pm 1\text{mV} - \pm 100\text{V}$ , Basic Accuracy, 0.1%

**Source and monitor units (SMU2-4):** 3 units  
**Output/Measurement Range:** Current,  $\pm 100\text{pA} - \pm 100\text{mA}$ , Basic Accuracy, 0.3%; Voltage,  $\pm 1\text{mV} - \pm 100\text{V}$ , Basic Accuracy, 0.1%

**Ground unit:** 1 unit  
**Output Voltage:** 0V; Accuracy,  $\pm 2\text{mV}$

**Voltage source (Vs):** 2 units  
**Output Range:** 1mV -  $\pm 20\text{V}$ ; Basic Accuracy, 0.5%

**Voltage monitor (Vm):** 2 units  
**Measurement Range:**  $\pm 100\mu\text{V} - \pm 20\text{V}$ , Basic Accuracy, 0.2%

### Capacitance-Conductance Measurements

**Test frequency:** 1 MHz  $\pm 0.01\%$   
**OSC level:** 30 mVrms  $\pm 20\%$  and 10 mVrms  $\pm 20\%$   
**Measurement range:** (Maximum resolution to full scale)  
**C:** 0.001 pF - 1.2 mF; basic accuracy, 0.5%  
**G:** 0.01  $\mu\text{S}$  - 12 mS; basic accuracy, 1.5%  
**DC bias voltage for capacitance measurements:**  $\pm 100\text{V}$

### General Specifications

**Operating temperature range:** 10°C - 40°C,  $\leq 70\%$  RH at 40°C  
**Power requirements:** 100V, 120V, 200V  $\pm 10\%$ ; 240V  $+5\% - 10\%$ ; 48-66 Hz, 510 VA max.  
**Dimensions:** cabinet, 600 mm(W) x 1600 mm(H) x 800 mm(D); switching matrix, 406 mm(W) x 210 mm(H) x 380 mm(D)  
**Weight:** cabinet with instruments, approximately 200 kg; switching matrix, approximately 25.3 kg

### System Controller

**Required Controller:** HP 9000 Series 200 Model 236A, 236C, 236S or 236CS, or Series 300 Model 310, 330, 350, 332, 360 or 370  
**System Language:** BASIC 5.1 or later for Series 200/300

### Ordering Information

**HP 4062B** Semiconductor parametric test system  
(does not include controller) \$10,940

Opt 050/060 For 50/60Hz Line Frequency <sup>1</sup>	\$0
Opt 100/120/220/240 For 100/120/220/240 Line Voltage <sup>2</sup>	\$0
Opt 001 12-pin Configuration (delete 36 pins)	-\$21,600
Opt 002 24-pin Configuration (delete 24 pins)	-\$14,400
Opt 003 36-pin Configuration (delete 12 pins)	-\$7,200
Opt 004 Additional Pin Board	+\$600
Opt 011 SMU Board	+\$1,380
Opt 030 For HP 9000 Series 300 Controller <sup>3</sup>	\$0
Opt 036 For HP 9000 Model 236 A/S/C/CS Controller <sup>4</sup>	\$0
Opt 310 Add HP 4274A	+\$12,900
Opt 311 $\pm 35\text{V}$ Internal DC Bias for HP4274A	+\$890
Opt 312 $\pm 100\text{V}$ Internal DC Bias for HP4274A	+\$830
Opt 405 Right-to-copy	+\$1,760
Opt 102 Delete HP4280A	-\$11,100
Opt 110 Delete Test Fixtures for Packaged Devices	-\$4,190
Opt 401 SPN Data File Creation Software	+\$2,010
Opt 503 Personality Board for EG 1034X, EG 2001X	\$0
Opt 920 Extra System Library	+\$350

<sup>1</sup>Must select Opt 050 according to the power line frequency used.

<sup>2</sup>Must select Opt 100, 120, 220 or 240 according to the power line voltage used.

<sup>3</sup>Must select Opt 503 if using an Electroglas Prober.

<sup>4</sup>Must select Opt 030 or 036 according to the system controller used.

# SEMICONDUCTOR TEST EQUIPMENT

## Semiconductor/Component Test System

Model 4061A

- Ready to use—supplied with 7 turn-key application pacs
- Reliable impedance and current measurements with one probing
- Productivity improvement through accurate and fast measurement over wide range

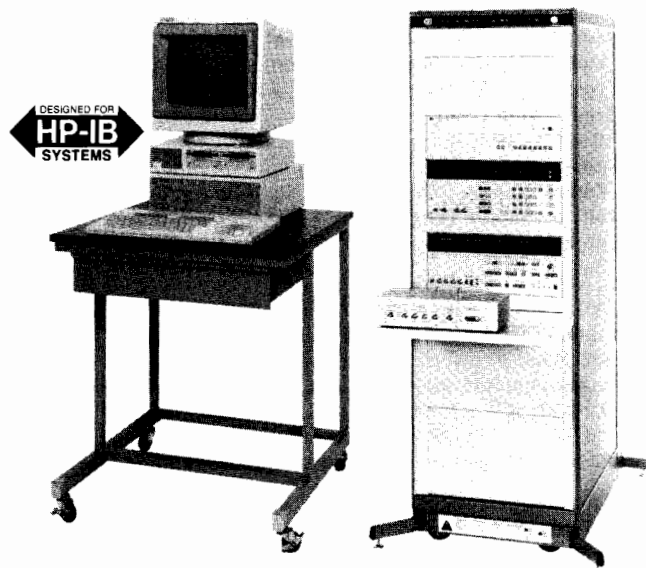

DESIGNED FOR  
HP-IB  
SYSTEMS

HP 4061A

System controller and table are sold separately

### Description

The HP 4061A Semiconductor/Component Test System is a dedicated system for making efficient, automatic evaluation of the fundamental characteristics of semiconductor and electronic components required in R & D and production areas. This system employs reliable, accurate measurements and high speed data processing to perform more reliable evaluations with speed and less manpower. The HP 4061A is supplied with 7 sophisticated applications programs and is flexible in both software and hardware. Thus, the system can output measurement results in nearly any required data format.

The switching subsystem, designed especially for use with the HP 4061A, allows both impedance and current measurement without changing DUT connection. Using this new switching subsystem, and by making impedance measurements, the HP 4061A performs evaluation of Doping profile, Oxide capacitance, Flat band condition, Threshold voltage, Surface charge, and Minority carrier life time/surface generation velocity. The HP 4061A also measures leakage current and reverse/forward current-voltage characteristics. Surface state density evaluation, using both high (e.g., 1 MHz) and low frequency (Quasi-static) C-V measurements and data processing are also possible by making modifications to system software.

The system offers significant improvement in both yield and quality in production through fast and reliable measurements and evaluations. It is also a valuable evaluation tool for the development of new materials and devices. The HP 4061A provides the flexibility to meet the future measurement requirements of the electronics industry.

### System Configuration

- pA Meter/DC Voltage Source (4140B)
- Multi-frequency LCR Meter (4275A)
- Switching Subsystem
- Rack Cabinet (29402C)

### Furnished Application Software

Semiconductor high/low frequency C-V characteristics, I-V characteristics, C-t characteristics and Zerbst analysis, Impedance Frequency/Bias characteristics, Ideal C-V curve.

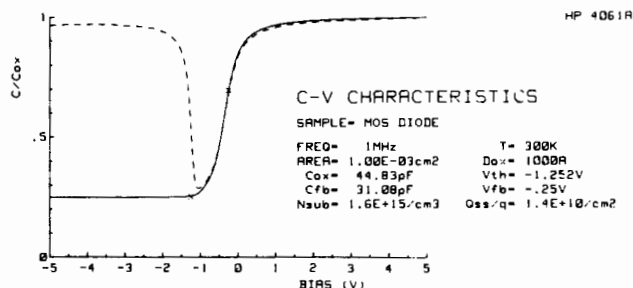

### Specification

For detailed specifications on each of the instruments used in the HP 4061A, refer to the individual data sheets.

### Switching Subsystem

The switching subsystem consists of a switch control module and switching module with interconnecting cables.

**Function:** Switches connection from DUT to either Multi-frequency LCR Meter or the pA Meter/DC Voltage source.

**System Measurement Range** (only deviations from individual instrument specifications are listed.)

#### Impedance Measurements (HP 4275A)

**Frequency range:**  $\leq 1$  MHz

**Measurement parameters:** C-G

**Capacitance:**  $\leq 2000$  pF (with  $D \leq 0.1$ )

**\*Accuracy:** (accuracy of HP 4275A)  $\times 1.5 + \Delta C$  (at  $23^\circ\text{C} \pm 5^\circ\text{C}$ ).

$$\Delta C = 1.4 \times 10^{-3} C \times f^2 \text{ (pF)} + 5 \text{ counts}$$

**Conductance:**  $\leq 12\text{mS}$  ( $D \leq 0.1$ )

**\*Accuracy:** (accuracy of 4275A)  $\times 1.5 + \Delta G$  (at  $23^\circ\text{C} \pm 5^\circ\text{C}$ )

$$\Delta G = 6 \times 10^{-3} C \times f(S) + 5 \text{ counts}$$

\* f: frequency in MHz

Cx: Measured capacitance value in pF

At  $5^\circ\text{C}$  to  $40^\circ\text{C}$ ,  $\Delta C$  and  $\Delta G$  doubles. Example: Assuming  $C_x = 1000$  pF and  $f = 1$  MHz,  $C = (1.4 \times 10^{-3} \cdot 10^3 \cdot (1)^2) \text{pF} + 5 \text{ counts} = 1.4 \text{ pF} + 5 \text{ counts}$

#### Current Measurements (HP 4140B)

**Accuracy:** (accuracy of HP 4140B)  $\times 1.5 + 5$  counts

After one-hour warmup and at DUT terminal of switching module

#### Impedance Measuring Section (HP 4275A)

See the HP 4275A's page 312.

#### Current Measurement Section (HP 4140B)

See the HP 4140B's page 532.

### General Information

**Operating temperature:**  $5^\circ\text{C}$  to  $40^\circ\text{C}$ ,  $\leq 70\%$  RH at  $40^\circ\text{C}$

**Power:** 100, 120, 220, and 240V,  $+5\% - 10\%$ , 48 to 66 Hz, 520 VA

**Size:** 535mm W x 1635 mm H x 770 mm D

**Weight:** Approximately 125 kg.

### System Controller

HP 9000 Series 200 Model 226A, 226S, 236A or 236S, or Series 300 Model 310 or 330

### Ordering Information

**HP 4061A Semiconductor/Component Test System** (does not include controller)

**Price**  
\$48,900

**Opt. 001:**  $\pm 100$  V dc Bias for HP 4275A

N/C

**Opt. 002:** 1-3-5 Frequency Steps for HP 4275A

N/C

**Opt. 026\*:** For HP 9000 Model 226 A/S controller

N/C

**Opt. 031\*:** For HP 9000 Model 310 or 330 controller

N/C

**Opt. 036\*:** For HP 9000 Model 236 A/S controller

N/C

\*Must order either OPT. 026, 031 or 036.

# SEMICONDUCTOR TEST EQUIPMENT

Switching Matrix

HP 4085M

525

- 48 pins with 1pA resolution

- Easy programmable switching

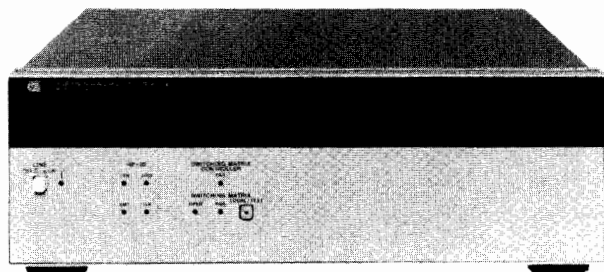

Switching Matrix Controller

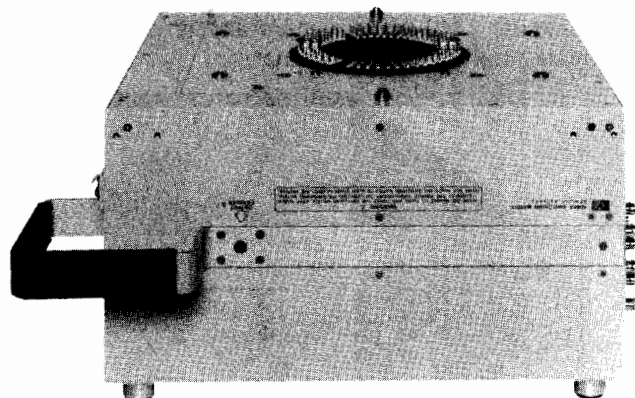

Switching Matrix

HP 4085M

## HP 4085M Description

Combining the HP 4085M switching matrix with the HP 4145B Semiconductor Parameter Analyzer produces a 1 pA, 1 mV switching system capable of 48-pin high resolution semiconductor testing.

A design which minimizes both noise and leakage current means exceptional built-in dc measurement capabilities and the realization of 1 pA resolution measurements at any one of the 48 pins.

The software included with the system makes it possible to freely switch any one of the eight instrument ports to any one of the test pins from the system controller. A number of fixtures are available for wafer and various packaged device measurements. The HP 4085M retains the HP 4145B's full measurement capabilities to obtain highly reliable wide range dc parameter measurements.

## Specifications

### Switching Matrix

**DUT Pins:** From 12 to 48 pins can be installed.

**Instrument Ports:**\* Eight instrument ports are included.

**Low Leakage SMU Port:** 1 ea. (Port 1)

**SMU Ports** : 3 ea. (Port 2 - 4)

**Vs Ports** : 2 ea. (Vs Port 1 and 2)

**Vm Ports** : 2 ea. (Vm Port 1 and 2)

\*SMU: Stimulus Measurement Unit

Vs : Voltage Source

Vm : Voltage Monitor

**Maximum Voltage between Instrument Ports:** ±220 Vdc

**Maximum Current at each DUT Pin:** ±500 mA dc

### General Specifications

**Operating temperature:** 10°C to 40 °C; ≤70% RH at 40°C

**Air cleanliness:** class 100,000 or higher clean room required.

**Power requirements:** 100, 120, 220V ± 10%; 240V+5%–10%; 48 to 66 Hz, 130VA max

**Size:** Switching Matrix, 406W × 210H × 380D mm; Switching Matrix Controller, 426W × 134H × 432D mm

**Weight:** Switching Matrix, approximately 25.3kg; Switching Matrix Controller, approximately 8kg

### System Controller

**Required Controller:** HP 9000 Series 200 Model 216S, 236A or 236S, or Series 300 Model 310, 330, 332, 350, 360 or 370

**System Language:** Basic 2.0 or later version

**Memory Size:** ≥ 320k byte

### Ordering Information

HP 4085M switching matrix (does not include controller)

### Price

\$53,700

Opt 001 12-pin system —\$22,800

Opt 002 24-pin system —\$15,200

Opt 003 36-pin system —\$7,600

Opt 004 Add one pin +\$640

Opt 016\* For HP 9000 Model 216A/S controller \$0

Opt 030\* For HP 9000 Model 310 controller \$0

Opt 036\* For HP 9000 Model 236 A/S controller \$0

\* Must select Opt. 016, 030 or 036 according to the system controller used.

## System Configuration Example

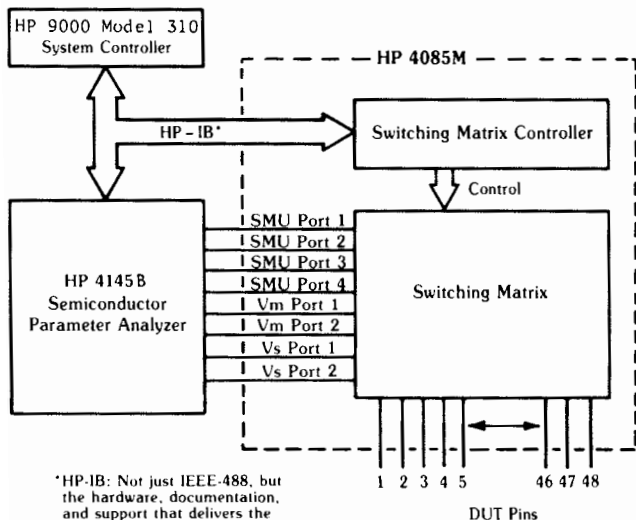

\*HP-IB: Not just IEEE-488, but the hardware, documentation, and support that delivers the shortest path to a measurement system.

# SEMICONDUCTOR TEST EQUIPMENT

## Semiconductor Parameter Analyzer

HP 4145B

- Fully automatic, high-speed dc characterization of semiconductor devices.
- High resolution, wide range sourcing and measurement.  
I: 50fA – 100mA, V: 1mV – 100V
- Maximum 1140 measurement and display points for precise measurement and analysis.
- Flexible graphic analysis functions for quick parameter extraction.
- Built-in micro flexible disc drive for storage of 240 user programs or 105 measurement results.

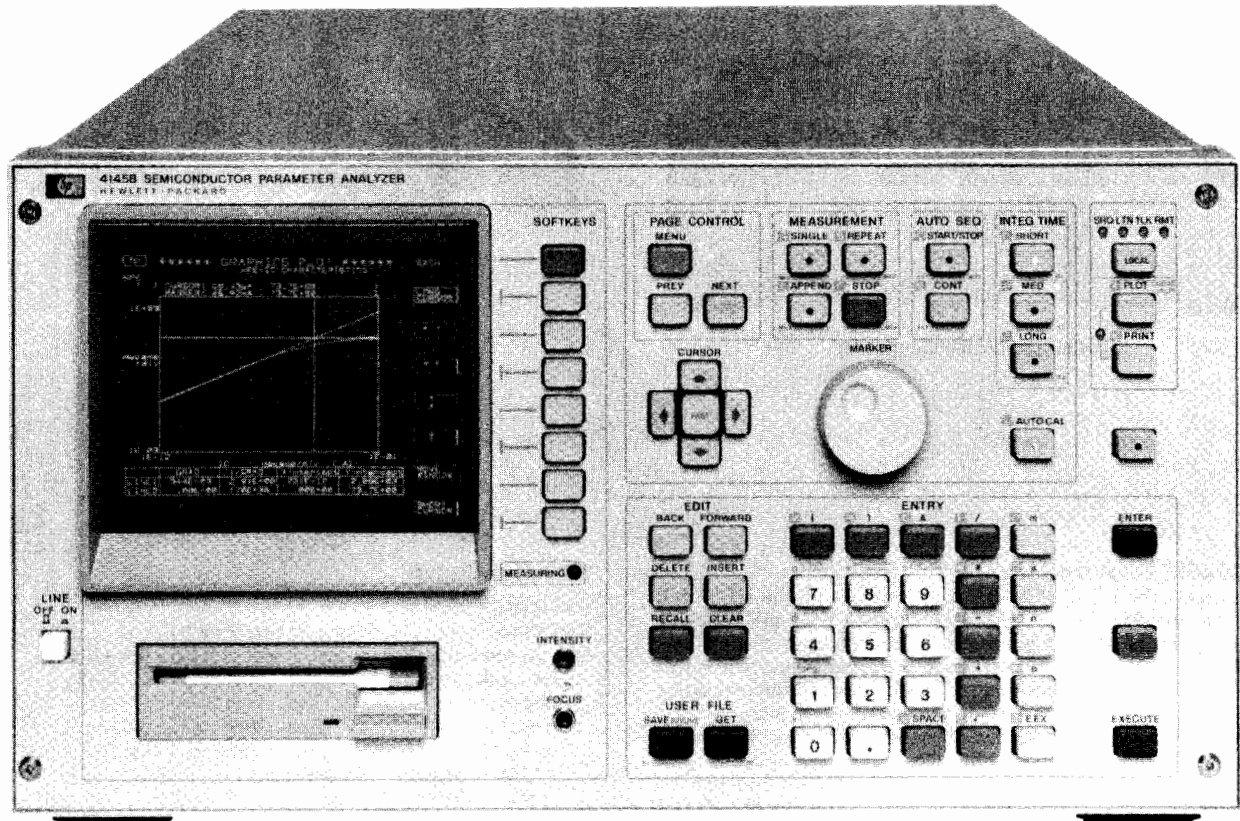

HP 4145B



### HP 4145B Semiconductor Parameter Analyzer

Designed for production line and laboratory use, the HP 4145B is the electronics industry's first stand-alone instrument capable of complete dc characterization of semiconductor devices and materials. It stimulates voltage and current sensitive devices, measures the resulting current and voltage responses, and displays the results in a user-selectable format (graph, list, matrix or schmo) on a built-in CRT display. An on-board programmable calculator provides real-time calculation of voltage/current dependent parameters, such as the current gain ( $h_{FE}$ ) and transconductance ( $g_m$ ) of transistors, which also can be displayed on the CRT. A number of powerful graphic analysis tools—marker, cursor, line function, interpolation—enhance the HP 4145B's basic capabilities and provide fast, accurate analysis of semiconductor devices, leading to increased production yields and improved device quality.

Four built-in source monitor units (SMUs) are the heart of the HP 4145B. Each SMU can be independently programmed to function as either a voltage source/current monitor or a current source/voltage monitor. Thus, a bipolar transistor, for example, can be completely characterized in common-base, common-emitter, and common-collector configurations without changing connections—only changing the SMUs' operating modes is required. The HP 4145B is also equipped with two voltage sources and two voltage monitors for measurements on devices having more than four terminals, such as ICs.

The HP 4145B can be controlled from the front panel via the HP-IB (standard), or by measurement setups stored on diskettes.

Displayed information—measurement setups, auto-sequence programs, measurement results—can be dumped directly onto an external graphics plotter to obtain publication quality hard copies. Additionally, the built-in 3½" flexible-disk drive enables you to store measurement setups and measured data, which can be accessed by another compatible HP disc drive for further processing.

#### Auto Sequence Programs

Measurement programs stored on a HP 4145B micro flexible disc can be linked by an auto sequence program, making it possible to perform a series of measurements with just one keystroke.

#### Four User-Selectable Display Formats to Suit the Evaluation

Measurement results can be displayed in one of four display formats: GRAPHICS, LIST, MATRIX or SCHMOO. After measurement has been made and the results displayed, the softkeys can be used to access various analysis functions for complete device evaluation. These functions include MARKER for numeric readout of measured value at any point along a plotted curve, CURSOR for numeric readout of value at any graphic point and for line positioning, STORE /RECALL for overlay comparisons, AUTO SCALE for optimum graphic scaling, and LINE FUNCTION for direct readout of line gradient and X-Y axes intercept values.

## Specifications

### Measurement

**Source/Monitor unit (SMU):** four SMUs are built into the HP 4145B. Each SMU can be programmed to source voltage and monitor current, or conversely to source current and monitor voltage. Each SMU can also be programmed to COM mode. This sets voltage at 0 volts and current compliance at 105 mA.

**Output/measurement resolution:** voltage, 4½ digits; current, 4 digits

**Voltage measurement input resistance/current source output resistance:**  $\geq 10^{12}\Omega$

**Maximum capacitive load:** 1000 pF

### SMU Voltage Range, Resolution and Accuracy

Voltage Range	Resolution	Accuracy <sup>1,2</sup>	Max. Current
±20V	1mV	$\pm(0.1\%+10mV+0.4\times I_o)$	100mA
±40V	2mV	$\pm(0.1\%+20mV+0.4\times I_o)$	50mA
±100V	5mV	$\pm(0.1\%+50mV+0.4\times I_o)$	20mA

\* $I_o$  is SMU output current in amps.

### SMU Current Range, Resolution and Accuracy

Current Range	Resolution	Accuracy <sup>1,2</sup>	Max. Voltage
±100mA	100µA	$\pm(0.3\%+100\mu A+2\mu A\times V_o)$	20V(>50mA)
			40V(>20mA)
±10mA	10µA	$\pm(0.3\%+10\mu A+200nA\times V_o)$	100V(≤20mA)
±1000µA	1µA	$\pm(0.3\%+1\mu A+20nA\times V_o)$	
±100µA	100nA	$\pm(0.3\%+100nA+2nA\times V_o)$	
±10µA	10nA	$\pm(0.3\%+10nA+200pA\times V_o)$	
±1000nA	1nA	$\pm(0.5\%+1nA+20pA\times V_o)$	
±100nA	100pA	$\pm(0.5\%+100pA+2pA\times V_o)$	
±10nA	10pA	$\pm(1\%+15pA+200fA\times V_o)$	
±1000pA	1pA	$\pm(1\%+6pA+20fA\times V_o)$	

\* $V_o$  is SMU output voltage in volts.

\*\*50 fA resolution in current monitor mode.

- Accuracy specifications are given as  $\pm\%$  of reading or setting value  $\pm\%$  of range.
- Accuracy tolerances are specified at 25°C  $\pm 5^\circ\text{C}$ , after a 40 minute warm-up time, with AUTO CAL on, and specified at the rear panel connector terminals referenced to SMU common. Tolerances are doubled for the extended temperature range of 10°C to 40°C.

### SMU Voltage/Current Compliance

**Maximum voltage compliance:** 20 V, 40 V, or 100 V, depending on the output current range.

**Maximum current compliance:** 20 mA, 50 mA, or 100 mA, depending on the output voltage range.

**Compliance setting resolution:** same as current and voltage output/measurement resolution. Maximum current compliance resolution, however, is 50 pA.

**Compliance accuracy:** voltage compliance accuracy is the same as voltage output/measurement accuracy. Current compliance accuracy is current output/measurement accuracy  $\pm$  (1% of range + 10 pA).

### Voltage/Current Sweep Characteristics

Output from up to three SMUs or voltage sources can be swept in one of three modes: VAR1, VAR2, or VAR1'.

**VAR1:** linear or logarithmic staircase sweep

**VAR2:** linear staircase sweep. Output from the VAR2 source is incremented after completion of each VAR1 sweep.

**VAR1':** output from the VAR1' source is synchronized with VAR1 but at levels proportional to a user-selectable ratio or offset relative to VAR1.

**Ratio:**  $\pm 0.01$  to  $\pm 10$

**Offset:** any value that will not cause VAR1' to exceed maximum allowable output.

**Hold time:** 0 to 650 seconds,  $\pm(0.5\% + 9\text{ ms})$  with 10 ms resolution

**Delay time:** 0 to 6.5 seconds,  $\pm(0.1\% + 5\text{ ms})$  with 1 ms resolution

**No. of Measurement Steps:** 1024 for a single VAR 1 sweep, 1140 for a multiple sweep

### Voltage Sources (Vs) Characteristics

**Number of sources:** two

**Output resistance:**  $\leq 0.2\Omega$

**Maximum capacitive load:** 1000 pF

### Voltage Output Range, Resolution and Accuracy

Output Voltage Range	Resolution	Accuracy	Max. Output Current
±20 V	1 mV	$\pm(0.5\%$ of setting + 10 mV)	10 mA

### Voltage Monitors (Vm) Characteristics

**Number of monitors:** two

**Input resistance:** 1 M $\Omega$   $\pm$  1% shunted by 100 pF  $\pm$  10%

### Voltage Measurement Range, Resolution and Accuracy

Measurement Voltage Range	Resolution	Accuracy
± 2 V	100 µV	$\pm(0.5\%$ of reading + 10 mV)
±20 V	1 mV	$\pm(0.2\%$ of reading + 10 mV)

### Characteristics Common to SMUs, Voltage Sources & Voltage Monitors

**Maximum allowable terminal voltage:** 100 V peak across SMU and  $V_m$  input terminals, or SMU and  $V_S$  output terminals, or between those terminals and guard; and 42 V maximum from Common to Ground.

### Display

CRT size and screen resolution: 152.4 mm (6 inch) diagonal; 2048 x 2048 points.

**Display modes:** Graphics, Schmo, List, Matrix, and Time Domain  
**External CRT analog output:** X, Y and Z outputs of 0 to 1 Vdc into 330  $\Omega$  (X and Y) and 240  $\Omega$  (Z).

### Analysis

**Calculation:** two user functions can be input and keyboard calculations can be done using the following 11 operators: +, -, \*, /,  $\sqrt{\quad}$ , EXP, LOG, LN, \*\* (power), ABS (absolute) and  $\Delta$  (differential).

### Constants Available on the Keyboard

**q:** Electron charge ( $1.602189 \times 10^{-19}$  coulomb)

**k:** Boltzmann's Constant ( $1.380662 \times 10^{-23}$  J/ $^\circ\text{K}$ )

**e:** Dielectric constant of vacuum ( $8.854185 \times 10^{-12}$  F/m)

**Analysis functions:** overlay comparison with STORE/RECALL, Marker, Interpolate, Cursor, Auto scale, Zoom function ( $\leftarrow$ ,  $\rightarrow$ ,  $\leftrightarrow$ ,  $\updownarrow$ ,  $\updownarrow$ ), Line and Move Window.

### General Specifications

**Operating temperature range:** +10°C to +40°C;  $\leq 70\%$  RH at 40°C, permissible temperature change  $\leq 1^\circ\text{C}/5\text{ min}$ .

**Power requirements:** 100/120/220 V  $\pm 10\%$ ; 240 V - 10% + 5%; 48 to 66 Hz; 270 VA max.

**Dimensions:** 426 mm W x 235 mm H x 612 mm D (16.75" x 9.06" x 24.1")

**Weight:** 27 kg (59 lb) approximately.

### Reference Data

**SMU measurement time:** measurement time = response time + ranging time + integration time.

### SMU Response Time

Current Range	Setup/Settling Time	SMU Wait Time
100 nA to 100 mA 1 nA and 10 nA	2.7 ms	0.2 ms 47.5 ms

**Ranging time:** varies from 4 ms to 74 ms

**Integration time:** SHORT, MED and LONG

	SHORT	MED	LONG
50 Hz	3.6 ms	20 ms	320 ms
60 Hz		16.7 ms	267 ms

### Accessories Furnished

HP 16058A Test Fixture

HP 04145-61501 System Disc

HP 04145-60001 Connector Plate

HP 04145-61622 Triaxial Cable (3m), 4 ea.

HP 04145-61630 BNC Cable (3m), 4 ea.

HP 04145-61623 Shorting Connector

### Ordering Information

HP 4145B Semiconductor Parameter Analyzer

Opt 050/060 50Hz/60Hz Line Frequency

**Price**

\$27,500

\$0

# SEMICONDUCTOR TEST EQUIPMENT

## Modular DC Source/Monitor HP 4142B

- Flexible, modular architecture
- Wide measurement range with high resolution  
V:  $\pm 4\mu\text{V}$  -  $\pm 200\text{V}$ , 0.05%  
I:  $\pm 20\text{fA}$  -  $\pm 10\text{A}$ , 0.2%
- Pulse measurement capabilities  
Pulse width 1ms - 50ms, 100 $\mu\text{s}$  resolution

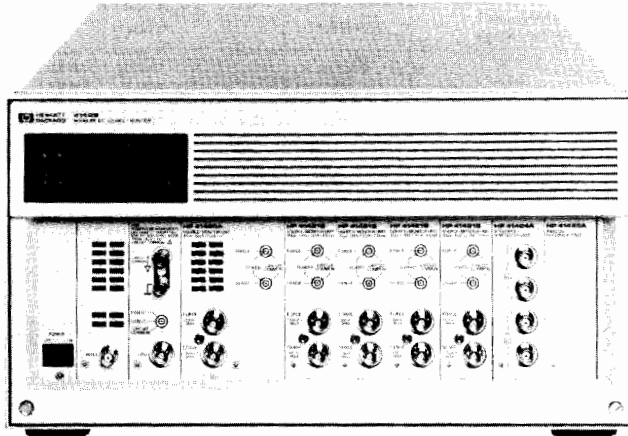

HP 4142B



### HP 4142B Modular dc Source/Monitor

Offering a wide measurement range and excellent sensitivity, the HP 4142B modular dc source/monitor is a system-use dc measurement instrument especially designed for high throughput dc semiconductor testers. A completely user-definable system component, the HP 4142B's modular architecture allows you to build a custom-configuration to suit your measurement needs.

Eight plug-in module slots can accommodate any combination of the five presently available modules, and as new modules become available, you can upgrade your measurement capabilities with ease. Choose from two types of Source/Monitor Units (SMUs) to force or measure up to  $\pm 200\text{V}$  and  $\pm 1\text{A}$ ; a High Current Source/Monitor Unit (HCU); a Voltage Source/Voltage Monitor Unit (VS/VMU); and an Analog Feedback Unit (AFU). Also, the HP 4142B's instrument command and measurement data storage capabilities, coupled with the high speed HP-IB interface, minimize computer loading, enhance throughput, and simplify systemization.

### Versatile SMUs and Reliable Measurement

For general-purpose dc or pulsed measurement, use the HP 41421B Source Monitor Unit. The equivalent of four instruments, this precision module forces voltage up to  $\pm 100\text{V}$  and simultaneously measures currents down to 20fA. It can also force currents up to  $\pm 100\text{mA}$  while measuring voltage down to 40 $\mu\text{V}$ .

If you test high power components or desire an extra wide measurement range, apply the HP 41420A Source Monitor Unit. This versatile SMU can source  $\pm 200\text{V}$  or  $\pm 1$  ampere (14W, DC or pulsed) and still maintain an incredible measurement resolution of 40 $\mu\text{V}$  and 20fA. Both SMUs include a compliance feature which limits output voltage, current, or power to prevent damage to your device. Each SMU (HP 41420A or HP 41421B) acts as either a voltage source/current monitor or current source/voltage monitor. These complimentary operating modes let you change the stimulus on a device without modifying the physical connections. This versatility reduces test time and eliminates instabilities caused by changing connections at the DUT.

- High speed measurement (typical)  
Sourcing or monitoring: 4ms  
Vth, hFE extracting: 12ms
- Internal memory  
Program memory: > 500 commands (typical)  
Data memory: 4004 measurement points

### Test Power Devices to 10 Amperes

The HP 41422A High Current source/monitor Unit (HCU) is a 10 ampere plug-in module which extends the pulsed test capability of the HP 4142B family products. The HCU greatly expands the HP 4142B's ability to test power devices such as GaAs FETs, power MOSFETs, smart ICs and so on.

Fast pulse testing at high currents increases test reliability by minimizing the effects of thermal drift. The HCU's fast 100 $\mu\text{s}$  pulse width is ten times narrower than previous HP 4142B modules.

### High Speed Parameter Extraction by Analog Feedback Technique

To find important parameters that are specified at a given voltage or current, such as  $V_t$  or hFE, connect the HP 41425A Analog Feedback Unit to two SMUs. The AFU modulates the output voltage of one SMU while monitoring the current or voltage of the second SMU. Target currents and voltage are found with blazing speed (12ms). This unique analog feedback network rapidly measures  $V_t$ , hFE,  $\Delta L$ , or  $\Delta W$ ; parameters which would require excessive test times on other parametric testers.

You can also use AFUs for biasing and testing microwave devices. It can be integrated into the Network Analyzer System.

By using AFUs, you can eliminate the effect of device thermal drift and can hold initial setting bias for AC measurement time.

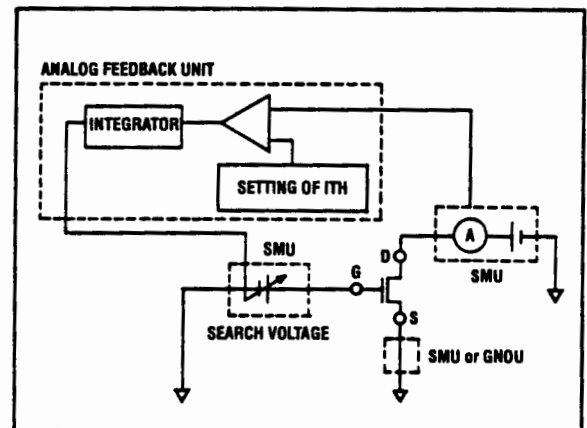

### Pulsed Measurements

The HP 4142B performs pulsed spot measurement, pulsed sweeps, or even sweeps with a pulsed bias, over its entire measurement range. Now you can safely evaluate GaAs FETs, power MOSFETs, and bipolar transistors under high power conditions.

The pulsed measurements will not damage your devices or test fixtures, and more importantly, it will reduce thermal drift.



**Specifications**

**4142B Modular DC Source/Monitor Ground Unit (GNDU)**

- Use as measurement ground.
- 0V, Kelvin connection
- Offset voltage:** ±500µV max
- Current range:** ±1.6 amperes
- Maximum cable resistance:**
  - FORCE terminal:** ≤1Ω\*
  - SENSE terminal:** ≤10Ω\*
- Maximum capacitive load:** 10µF max\*

**Spot measurements**

Source and monitor DC current or voltage.

**Sweep measurements**

- One channel (HP 41420A SMU, HP 41421B SMU, HP 41422A HCU, or HP 41424A VS/VMU) can sweep current or voltage while up to 8 channels measure current or voltage.
- A second sweep channel can be slaved to the first sweep channel (dual synchronous sweep).
- Sweep modes:** Linear or logarithmic.
  - Single or double staircase.
- Sweep parameters:** Start, stop, number of steps, or steps per decade.
- Maximum number of steps:** 1000
- Hold time:** 0 to 655.35 sec, 10 msec resolution
- Delay time:** 0 to 65.535 sec, 1 msec resolution
- Setting accuracy:** 0.5% + 1 msec\*

**Measurement Unit HP 4142B Modules**

Model Number	Slots Req'd	Voltage Range	Current Range	Measurement Resolution	Output Power	Accuracy V	Accuracy I
HP 41420A SMU <sup>1</sup>	2	±100µV to ±200V	±50fA to ±1 amp	40µV 20fA	14W	0.05%	0.2%
HP 41421B SMU <sup>1</sup>	1	±100µV to ±100V	±50fA to ±100 mA	40µV 20fA	2W	0.05%	0.2%
HP 41422A	2	±200µV to ±10V	±500µA to ±10A	40µV 20µA	12W	0.5%	0.5%
HP 41424A VS/VMU	1	±1 mV to ±40V	±20mA, ±100mA	4µV <sup>2</sup> 20µA	2W	0.05%	3%
HP 41425A AFU	1	Searches for a specified current or voltage on one SMU by controlling the voltage output of another SMU.					

<sup>1</sup>Provides Kelvin connections (remote sensing).  
<sup>2</sup>Differential measurement mode (40 µV resolution in normal mode).

**SMU Range, Resolution and Accuracy (at 18°C-28°C)**

Voltage Range	Set Res.	Meas. Res.	Accuracy	Max. Current
±2V	100µV	40µV	±0.05%±1mV	1A
±20V	1mV	400µV	±0.05%±10mV	1A(V≤14V) 0.7A(V>14V)
±40V	2mV	800µV	±0.05%±20mV	350mA
±100V	5mV	2mV	±0.05%±50mV	125mA
±200V	10mV	4mV	±0.05%±100mV	50mA

Current Range	Set Res.	Meas. Res.	Accuracy	Max. Voltage
±1nA	50fA	20fA	±1%±(0.1+0.2 x Vo/100)%±5pA	200V
±10nA	500fA	200fA	±0.5%±(0.1+0.2 x Vo/100)%	
±100nA	5pA	2pA		
±1µA	50pA	20pA	±0.2%±(0.1+0.2 X Vo/100)%	
±10µA	500pA	200pA		
±100µA	5nA	2nA		
±1mA	50nA	20nA		
±10mA	500nA	200nA	±0.5%±(0.1+0.2 X Vo/100)%	
±100mA	5µA	2µA		
±1A	50µA	20µA		
				100V (I>50mA)
			200V (I≤50mA)	
			100V (125mA ≥I>50mA)	
				40V (350mA ≥I>125mA)
				20V (0.7A ≥I>350mA)
				14V (I>0.7A)

\*Vo is the SMU output voltage, in volts

**Pulsed measurements (SMU)**

- Force and measure pulsed current or voltage.
- Ranges:** 2V range: 10nA to 1A range  
20V to 200V range: 100µA to 1 A range
- V pulse:** 2V range: 1 compliance ≥ 2nA  
20V to 200V range: 1 compliance ≥ 20µA
- I pulse:** 10nA to 10µA range: V compliance ≤ 2V  
100µA to 1A range: V compliance ≤ 200V
- Pulse width:** 1-50 msec, 100µsec resolution
- Pulse period:** 10-500 msec, 100µsec resolution
- Setting accuracy:** 0.5% + 100µsec\*

**Pulsed sweeps**

- Sweep and measure pulsed current or voltage.
- Sweep DC current or voltage while pulsing current or voltage. Use Pulse and Sweep specification.

**Memory**

- Program memory:** Stores approximately 500\* HP-IB commands which can be grouped into 99 subroutines.
- Data memory:** 4004 measurement points (binary).  
1001 points (ASCII format).

**General Specifications**

**Auto calibration**

Automatically calibrates the offset errors in each measurement unit every 30 minutes.\*

**Environmental information**

- Operating temperature:** 5°C to 40°C
- Allowable temperature drift:** ±3°C\*
- Operating humidity:** 5% to 80% RH
- Storage temperature:** -40°C to 65°C
- Storage humidity (at 65°C):** ≤90% RH
- Operating inclination:** ±20° from horizontal

**Power requirements**

100/120/220V ±10%, 240V-10%+5%, 48 to 66Hz, 750 VA max

**Dimensions**

426 mm W x 235 mm H x 676 mm D

**Weight**

- HP 4142B:** Approximately 23kg
- HP 41420A:** Approximately 4kg
- HP 41422A:** Approximately 3kg
- HP 41421B/41424A/41425A:** Approximately 2kg

**Recommended computer**

HP 9000 Series 200 or 300 computer.  
BASIC Operating System (Version 3.0 or later).

**Software**

- Parameter measurement library:** Current gain, Breakdown voltage (2), Drain current, Threshold voltage (3), and Resistance.
- Test instruction set:** Initialize, Force, Measure, Pulse, Graphics, and Data storage.
- \* Reference data only.

**Ordering Information**

	<b>Price</b>
HP 4142B Modular dc source/monitor	\$11,510
Opt 001 System Cable for Use with 16058A	+\$226
Opt 002 Accessory Kit for System Use GDU/ Interlock Cables, Conn. Plate	+\$361
Opt 400 Install 41420A (needs 2 slots)	+\$4,510
Opt 401 Triaxial Cable for 41420A	+\$175
Opt 402 Quadaxial Cable for 41420A	+\$600
Opt 410 Install 41421B (needs 1 slot)	+\$3,725
Opt 411 Triaxial Cable for 41421B	+\$175
Opt 412 Quadaxial Cable for 41421B	+\$600
Opt 420 Install 41422A (needs 2 slots)	+\$5,000
Opt 422 Dual Coax Cable	+\$550
Opt 440 Install 41424A (needs 1 slot)	+\$3,390
Opt 442 Vs/Vm Cables (coaxial)	+\$340
Opt 450 Install 41425A (needs 1 slot)	+\$1,810
HP 41420A Source/Monitor Unit	\$4,510
Opt 402 Quadaxial Cable	+\$600
HP 41421B Source/Monitor Unit	\$3,725
Opt 412 Quadaxial Cable	+\$600
HP 41422A High Current Source/Monitor Unit	\$5,000
Opt 422 Dual Coax Cable	+\$550
HP 41424A Voltage Source/Voltage Monitor Unit	\$3,390
Opt 442 Vs/Vm Cables (coaxial)	+\$340
HP 41425A Analog Feedback Unit	\$1,810
HP 16058A Test Fixture	\$2,820
Opt 001 System Cable for 4142B	+\$60
HP 16088A Test Fixture	\$3,400

# SEMICONDUCTOR TEST EQUIPMENT

## Softpanel Interactive Measurement and Analysis Software

### HP 16276A

- Full feature parameter analyzer
- Menu-driven softpanels

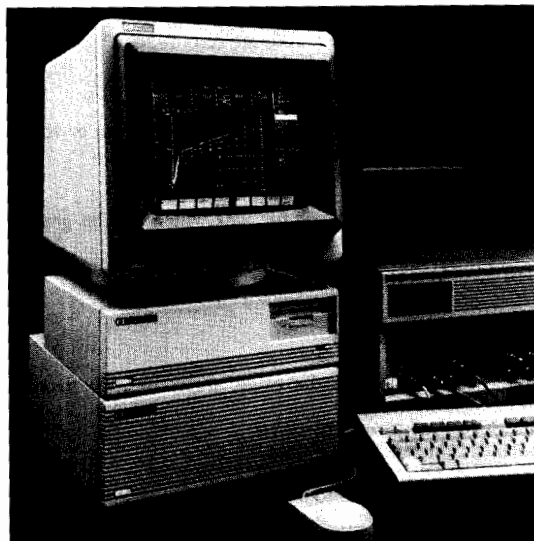

### HP Interactive Measurement and Analysis Software

HP Interactive Measurement and Analysis (IMA) Software makes semiconductor measurements interactively, using the HP 4142B DC Source/Monitor. The IMA software turns the HP 4142B into a fully automatic semiconductor dc parameter analyzer by providing an interactive softpanel user interface.

Now you can use the HP 4142B like the HP 4145B Semiconductor Parameter Analyzer, with the addition of the higher speed, wider dynamic measurement range, and more flexible module configuration of the HP 4142B, and with the enhanced capabilities of IMA software.

#### Easy to Use Softpanels

The IMA software provides easy-to-use softpanels. You use the mouse to reduce the measurement setup to a simple fill-in-the-blank operation. The mouse is also used to control the graphics analysis routines, the output formats, and the file management of the IMA.

#### Automatic Measurement and Analysis

You can perform most of the semiconductor analysis functions using the HP IMA softpanels. For automation or customization of measurement and analysis, use the unique Analysis Instruction Set (AIS). The AIS is the subprogram library of HP BASIC and an interface with the HP BASIC program, while the softpanel is the interactive user interface.

Setting up softpanels, triggering measurements, analyzing graphics, extracting data from and sending data to the graphics page, and managing files are made easy using the HP BASIC programming feature of the IMA software. By using the IMA softpanels, you can monitor and analyze program execution and manually reset parameters.

#### HP 4145B Compatibility

Data file upward compatibility is maintained with the HP 4145B for graphics and list data.

- Powerful graphics analysis for quick parameter retrieval
- Automatic measurement and analysis with HP BASIC subprogram library

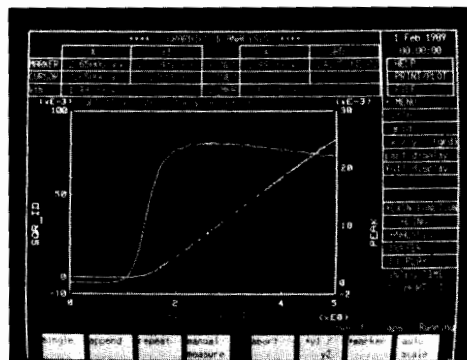

#### Specifications

##### Products supported by HP IMA

- HP 4142B Modular DC Source/Monitor Unit
- HP 41420A 200V/1A Source Monitor Unit (SMU)
- HP 41421B 100V/100mA Source Monitor Unit (SMU)
- HP 41424A Voltage Source/Voltage Monitor Unit

##### Measurement characteristics

###### Voltage/current sweep parameters

**Var1:** main sweep, single or double sweep; selectable linear or logarithmic

**Var2:** subordinate linear staircase sweep

**Var1':** staircase sweep synchronized with the Var1 sweep

**Time domain sweep:** selectable time domain when Var1 is not set

**Pulse:** every source unit can be set as a pulse source

**Constant:** every source unit can be set as a constant voltage or current source

**Measurement modes:** single, append, repeat, or manual

**Integration Time:** short, medium, or long

**Display modes:** graphics or list

##### Analysis capabilities

**User functions:** up to four user functions can be defined

**User display functions:** up to two functions can be defined as numeric expressions with the marker, cursor, or line analysis data; results are displayed real time

**Marker function:** interpolation, marker → min/max, or direct marker

**Cursor functions:** Cursor → marker, regression line, tangent line, line, fix line, or erase line

**Scaling functions:** auto scale, move, zoom, init scale, change scale, revise scale, or reset display

**Buffer function:** four buffers are available: store, recall, recall off, or exchange

**Display functions:** title, grid/tick, part display, full display, or auto retrieve function

##### System requirements

HP 9000 series 300 workstations: Model 310/320/330/332/340/350/360/370.

Minimum of 3 Mbyte memory

Graphics boards: HP 98542A/98543A (for 12 inch monitors), HP 98544A/98547A/98548A/98549A/98550A

Language system: HP BASIC 5.13 or later

Security module: HP 46084A

##### Ordering Information

HP 16276L License to use HP 16276A

HP 16276A HP IMA software media and manuals

Opt 005 5½ inch disks

Opt 006 3½ inch single-sided disks

Opt 007 3½ inch double-sided disks

Opt 910 Extra set of manuals

##### Price

\$3,750

\$650

\$0

\$0

\$0

+\$107

# SEMICONDUCTOR TEST EQUIPMENT

## DC Source/Monitor

### HP 4141B

531

- High speed measurements down to the pA range
- High reliability at low cost

- High accuracy and resolution  
 V:  $\pm 100\mu\text{V} - \pm 100\text{V}$ , 0.1%  
 I:  $\pm 50\text{fA} - \pm 100\text{mA}$ , 0.3%

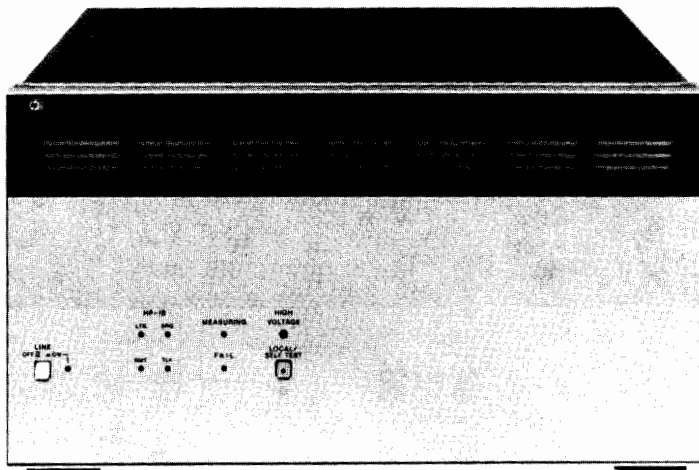

### Description

The HP 4141B dc source/monitor is designed for use as a system component in user-designed semiconductor I-V or dc parametric test systems. With its wide dc measurement range, high-resolution, high-speed measurement capabilities, remote sensing, and high accuracy, the HP 4141B contributes to quality improvement and increased measurement throughput in the lab or on the production line.

### High Speed Measurements with High Resolution

Four source/monitor units (SMU's) coupled with two voltage-source units (Vs's), two voltage monitor units (Vm's), and one ground unit (GNDU) make the HP 4141B equivalent to twenty one instruments. A stand-alone instrument capable of measuring dc parameters, the HP 4141B features high resolution measurements (50fA/100 $\mu\text{V}$ ) and a built-in timing controller. Typical time for a current or voltage measurement, which includes data transfer, is approximately 25ms. A swept measurement (51 points) takes approximately 490ms. High accuracy and high speed measurements, especially in the low current range, are exclusive features of the HP 4141B.

### High Reliability

The HP 4141B's high reliability significantly simplifies maintenance and reduces maintenance costs. To reduce system down time, the HP 4141B is designed for on-site service. Performance verification and diagnostic software for troubleshooting is also available.

### Specifications

#### Measurement Unit

**Source and monitor units (SMU):** 4 channels (Kelvin connection)  
 Each SMU can be programmed to source voltage and monitor current, or conversely to source current and monitor voltage.

#### SMU Range, Resolution and Accuracy

Voltage range	Resolution	Accuracy	Max. Current
$\pm 20\text{V}$	1mV	0.1% + 0.05%	100mA
$\pm 40\text{V}$	2mV		50mA
$\pm 100\text{V}$	5mV		20mA
Current Range	Resolution	Accuracy	Max. Voltage
$\pm 100\text{mA}$	100 $\mu\text{A}$	0.3% + (0.1 + 0.2 x Vout*/100)%	20V (I > 50mA)
			40V (20mA < I $\leq$ 50mA)
$\pm 10\text{mA}$	10 $\mu\text{A}$		100V (I $\leq$ 20mA)
$\pm 1000\mu\text{A}$	1 $\mu\text{A}$		
$\pm 100\mu\text{A}$	100nA		
$\pm 10\mu\text{A}$	10nA		
$\pm 1000\text{nA}$	1nA		
$\pm 100\text{nA}$	100pA	0.5% + (0.1 + 0.2 x Vout*/100)%	
$\pm 10\text{nA}$	10pA	1% + (0.1 + 0.2 x Vout*/100)% + 5pA	
$\pm 1000\text{pA}$	1pA**		

\*Vout is the SMU output voltage, in volts.

\*\*Max. Measurement Resolution is 50fA.

1. Accuracy specifications are given as % of reading when measuring or % of setting when reading.
2. Accuracy tolerances are specified at 23°C  $\pm 5^\circ\text{C}$ , after a 40-minute warm-up, with AUTO CAL on, and are specified at the rear panel connector terminals referenced to SMU common. Tolerances double for the extended temperature range of 10°C to 40°C.

**Output/measurement resolution:** Voltage - 4 1/2 digits  
 Current - 4 digits

**Voltage source units (Vs):** 2 channels

#### Voltage range, resolution, and accuracy

Output voltage range	Resolution	Accuracy	Max. Current
$\pm 20\text{V}$	1mV	0.5% of setting + 10mV	10mA

**Voltage monitor units (Vm):** 2 channels

#### Voltage range, resolution and accuracy

Measurement voltage range	Resolution	Accuracy
$\pm 2\text{V}$	100 $\mu\text{V}$	0.5% of reading + 10mV
$\pm 20\text{V}$	1mV	0.2% of reading + 10mV

**Ground Unit:** 1 channel (kelvin connection)

**Current range:**  $\pm 500\text{mA}$

### General Specifications

**Operating Temperature Range:** +10°C to +40°C,  $\leq 70\% \text{RH}$  at 40°C. Permissible temperature change  $\leq 1^\circ\text{C}/5\text{min}$ , Maximum wet-bulb temperature is 29°C.

**Power requirements:** 100/120/220V  $\pm 10\%$ , 240V-10%+5%, 48 to 66Hz, 240/VA max.

**Dimensions:** Approximately 426mm (16.77in)W x 235mm (9.25in)H x 612mm (24.1in)D

**Weight:** Approximately 19kg (41.5 lbs)

### Accessories Furnished

**HP 04085-61651** Interconnect Cable Assembly

**HP 04141-60001** Connector Plate

**HP 04145-61630** BNC Cable (3m) 4ea.

### Accessories Available

**HP 16058A** Test Fixture

**HP 16059A** Adapter (Using with 16058A)

**Price**

\$2,820

\$660

### Ordering Information

**HP 4141B** (dc source/monitor)

Opt 011 Extra SMU Board

Opt 050/060 \*50Hz/60Hz Line Frequency

\*Must select Opt. 050 or 060 according to the power line frequency used.

**Price**

\$23,100

+ \$1,450

\$0

# SEMICONDUCTOR TEST EQUIPMENT

## pA Meter/DC Voltage Source

HP 4140B

- 3 basic semiconductor measurements:  
I, I-V and quasi-static C-V
- Two programmable voltage sources
- Basic accuracy: 0.5%
- High resolution:  $0.001 \times 10^{-12}$  A
- HP-IB standard

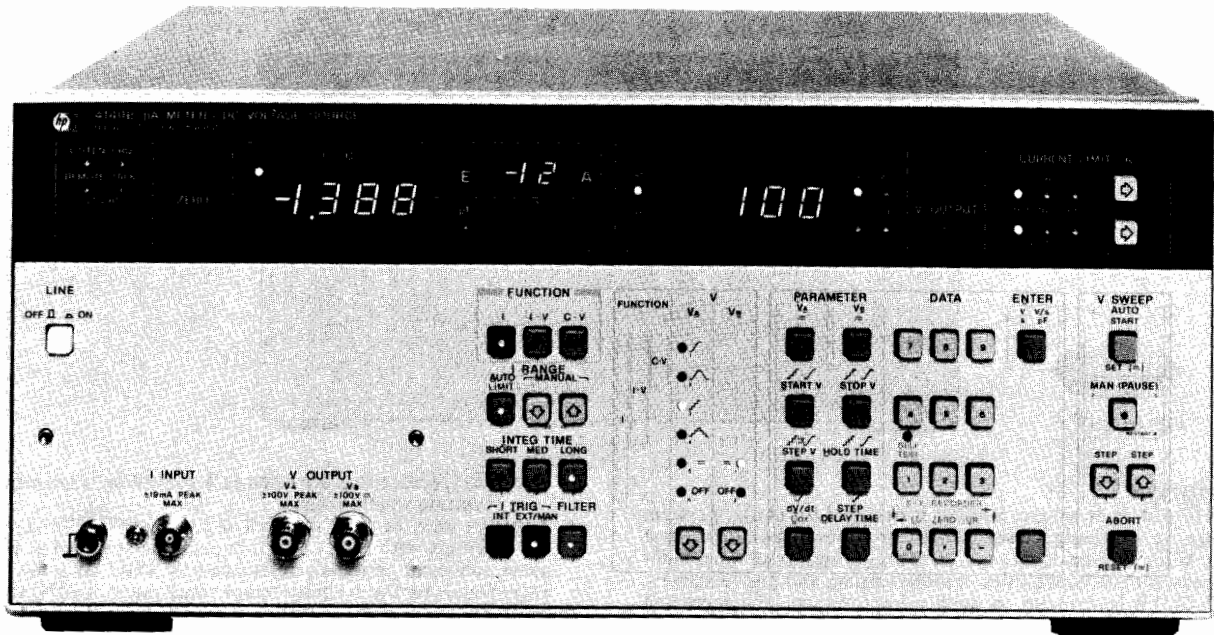

HP 4140B



### HP 4140B pA Meter/dc Voltage Source

The HP 4140B pA meter/dc voltage source is another in Hewlett-Packard's new generation of component measurement instrumentation. It consists of an extremely stable picoampere meter and two programmable dc voltage sources, one of which operates as a ramp and staircase generator as well as a dc source. These features make the HP 4140B ideal for making dc characteristic measurements such as leakage current, current-voltage characteristics and quasi-static C-V measurements required by the semiconductor industry for new product development and for improving production yields. It is equally useful in measurements of electronic components and materials to determine leakage currents or insulation resistances.

The HP 4140B can contribute to the development, production and quality control of semiconductor devices and to the improvement in the reliability of electronic components and equipment.

#### Stable pA Measurements

Stable picoampere measurements can be made with the HP 4140B with a maximum resolution of  $10^{-15}$ A. This is made possible by a new measurement technique in conjunction with an offset current capability, low noise test leads, and an electrostatic and light shielded test fixture. These features provide both stable and fast picoampere measurements.

This measurement technique is very useful in making small leakage current measurements and determining dc parameters of semiconductor devices or measuring the insulation resistance and leakage current for dielectric absorption measurements necessary in the analysis of capacitors or insulation materials.

#### Synchronized I-V Measurements

The HP 4140B makes automatic, synchronized current-voltage measurements that have required a large instrumentation system in the past.

The two voltage sources in the HP 4140B operate over a range of  $-100$  V to  $+100$  V with a maximum resolution of 10 mV. One operates only as a stable dc source while the other generates a staircase voltage, a precise ramp or a stable dc level.

By adding precise, programmable timing capability, we can now make fast, accurate I-V and C-V measurements. Device stabilization times, (time between the applied voltage and the subsequent current

measurement) can now be programmed from the front panel of the HP 4140B or via the HP-IB bus.

#### Quasi-Static C-V Measurements

Automatic quasi-static C-V measurements are easily accomplished by the ramp voltage capability of the HP 4140B. This measurement is highly significant in evaluating basic semiconductor characteristics.

The HP 4140B operates over a capacitance range of 0.1 pF to 1999 pF with a dc voltage ramp rate of 1 mV/s to 1 V/s in 1 mV/s increments. Capacitance, which is calculated from the measured current divided by the ramp rate, can also be provided as a percent of the capacitance of the oxide film ( $C_{ox}$ ) over a range of 0.0 to 199.9%. By providing the output voltage at each capacitance measurement point, we have the dc (quasi-static) C-V characteristics of the device under test.

#### HP-IB Capability

Interfacing the HP 4140B to an HP-IB system improves measurement efficiency and takes advantage of its high speed (approx 5 ms) measurement rate. Such a system will minimize measurement time of dc parameters of semiconductors and the insulation resistance and leakage current of electric components and materials. This allows rapid feedback to production for fast evaluation of a new device in the development stage.

#### Specifications

**Measurement functions:** I, I-V and C-V

**Voltage sources:** two separate sources ( $V_A$  and  $V_B$ )

$V_A$ :  $\pm 100$  V programmable source/function generator

$V_B$ :  $\pm 100$  V programmable dc voltage source

#### Measurement Function/Source Selection

Function	$V_A$	$V_B$
I		
I-V		
C-V		

**Voltage sweep:** auto or manual (pause)

**Current Measurements**

**Displays:** current, 3½ digits with 2 character annunciator. Voltage, 3½ digits.

**Measurement range:** ±0.001 × 10<sup>-12</sup>A to 1.000 × 10<sup>-2</sup>A full scale in 11 ranges.

**Overrange capability:** 99.9% on all ranges.

**Range selection:** auto (lowest current range is selectable) and manual

**Measurement Accuracy/Integration Time**

Range	Accuracy* ± (% of rdg. + counts)	Integration Time** (ms)		
		Short	Medium	Long
10 <sup>-2</sup> – 10 <sup>-9</sup>	0.5 + 2	20	80	320
10 <sup>-10</sup>	2 + 2			
10 <sup>-11</sup>	5 + 3	80	320	1280
10 <sup>-12</sup>	5 + 8	160	640	2560

\* Accuracy for long integration time. 23°C ± 5°C. humidity ≤ 70%. For short and medium integration time, see reference data section.

\*\* Integration times specified at 50 Hz. For 60 Hz operation, multiple time by 1.2.

**Zero offset:** cancels leakage current of test leads or test fixtures.

**Offset range:** 0 to ±100 × 10<sup>-15</sup>A.

**Trigger:** INT, EXT and HOLD/MAN

**Input terminal:** triaxial

**Capacitance-Voltage (C-V) Measurement**

**Measurement ranges:** 0.0 pF – 100.0 pF and 200 pF – 1000 pF full scale in two ranges; 99.9% overrange

**Ranging:** auto

**%C:** capacitance change of device under test is displayed as a percent of the set value of the oxide capacitance (Cox = 100%)

**%C range:** 0.0% – 199.9%

**Cox setting ranges (2 ranges):** 0.1 pF – 199.9 pF and 200 pF – 1999 pF

**Capacitance calculation accuracy:** accuracy is dependent on accuracy of both the current measurement and ramp voltage.

**Zero offset:** cancels stray capacitances of test fixtures and test leads.

**Offset range:** 0 to 100 pF

**High speed I data output:** available with HP-IB interface only. Outputs current measurement data at 4 ms intervals (max rate).

**DC Voltage Sources**

**Output Modes, VA and VB**

Function	VA	VB
I		--- (DC)
I-V		--- (DC)
C-V		--- (DC)

**Voltage ranges (VA and VB):** 0 to ±10.00 V and 0 to ±100.0 V in 2 ranges, auto range only.

**Maximum current:** 10 mA, both sources.

**Voltage sweep:** auto and manual (pause), up/down step in manual (pause) mode. Sweep abort standard.

**Operating Parameter Setting Ranges**

**Start voltage and stop voltage:** 0 – ±10.00 V, 0.01 V steps; 0 – ±100.0 V, 0.1 V steps

**Step voltage:** 0 – ±10.00 V, 0.01 V steps; 0 – ±100.0 V, 0.1 V steps

**Hold time:** 0 – 199.9 seconds in 0.1 s increments; 0 – 1999 seconds in 1.0 s increments

**Step delay time:** 0 – 10.00 seconds in 0.01 s increments; 0 – 100.0 seconds in 0.1 s increments

**Ramp rate (dV/dt):** 0.001 V/s – 1.000 V/s in 0.001 V/s increments

**Accuracy (at 23°C ± 5°C)**

**Output voltage:** ±10 V, ±(0.07% + 11 mV); ±100 V, ±(0.09% + 110 mV)

**Linearity:** typically 0.5%, 0 – ±10 V; < 5%, > 10 V.

**Current limit:** 100 µA, 1 mA and 10 mA, ±10% (VA and VB)

**Output terminals:** BNC; L-GND

**Reference Data**

**Current Measurement**

**Current Measurement Accuracy\***

Range	Integration Time	
	Short	Medium
10 <sup>-2</sup> – 10 <sup>-8</sup>	0.5 + 3	0.5 + 2
10 <sup>-9</sup>	0.5 + 3	0.5 + 3
10 <sup>-10</sup>	2 + 4	2 + 3
10 <sup>-11</sup>	5 + 10	5 + 4
10 <sup>-12</sup>	5 + 20	5 + 10

\* ± (% of rdg. + counts), 23°C

**Current ranging times:** 20 ms to 7.76 s. (longer ranging time needed for large changes in input signal level, especially on lowest current ranges).

\*When FILTER is on, current ranging time increases 60 ms (50 Hz power line) or 50 ms (60 Hz power line)

**Warm-up time:** ≥ 1 hour

**Common mode rejection ratio:** ≥ 120 dB (≤ 2 counts)

**Analog Output I, C and VA**

**Accuracy:** ±(0.5% + 20 mV)

**Low pass filter:** 3 position: OFF, 0.22 s ± 20% and 1s ± 20% applied to both VA and I/C data outputs

**Pen lift output:** TTL low level (≤ 0.8V) during sweep period in I-V and C-V functions

**Recorder output scaling:** pushbutton scaling of lower left and upper right limits of X-Y recorder

**HP-IB Interface**

**Remote controlled functions:** measurement function, current range, integration time, I data output trigger, voltage sweep controls, current limit, VA and VB voltages, zero (offset), self test and parameter settings (voltages, sweep/hold/delay times)

**Data Output**

- Measured data (I, C and VA),
- Voltage setting (VA and VB),
- Parameter settings

**General Information**

**Power:** 100, 120, 220, V ± 10%, 240 V +5% – 10%; 48-66 Hz, 135 VA max

**Size:** 426 mm W x 177 mm H x 498 mm D (16.5" x 7" x 19.6").

**Weight:** 14.4 kg (31.7 lb)

**Accessories Furnished**

**HP 16053A test leads:** consists of one triaxial cable, two each BNC-BNC cables and one connection plate with mating female panel-mount connectors. Cables are one meter in length.

**HP 16055A test fixture:** for general device measurements. Provides electrostatic and light shielding for stable pA measurements.

**Accessories Available**

**HP 16054A connection selector:** provides a simple method to select appropriate connection of low lead for the pA meter section.

**HP 16056A current divider (10:1):** for use only on the 10 mA range to extend the measurement capability to 100 mA.

**Ordering Information**

	Price
HP 4140B pA Meter/DC Voltage Source	\$10,950
Opt 907 Front Handle Kit (HP P/N 5061-0090)	\$76
Opt 908 Rack Flange Kit (HP P/N 5061-0078)	\$42
Opt 909 Rack & Handle Kit (HP P/N 5061-0084)	\$106
Opt 910 Extra Manual	\$54
Opt W30 Extended Repair Service. See Page 723.	

**Accessories**

HP 16054A Connection Selector	\$444
HP 16056A Current Divider (10:1)	\$238

☎ For same-day shipment, call HP DIRECT at 800-538-8783

# SEMICONDUCTOR TEST EQUIPMENT

## 1 MHz C Meter/C-V Plotter

HP 4280A

- Built-in sweepable dc bias source and timer for C-V (Capacitance-Voltage)/C-t (Capacitance-Time) measurements
- High speed C-t measurements with minimum measurement interval of 10 ms (10  $\mu$ s if an external pulse generator is used)
- Basic C measurement accuracy: 0.1%
- Test lead extension up to 5 m
- 5½-digit display resolution (option) for C measurement

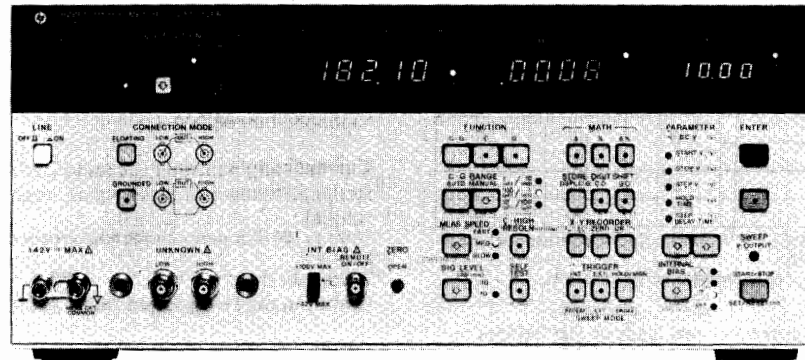

HP 4280A

### HP 4280A MHz C Meter/C-V Plotter

The HP 4280A 1 MHz C Meter/C-V Plotter measures the capacitance and conductance of semiconductor devices and materials as functions of applied voltage (C-V) or time (C-t). The HP 4280A consists of a precision 1 MHz C-G meter, a programmable dc bias source that can be swept in staircase fashion, and accurate timing control.

#### C-V and C-t Measurements

The HP 4280's internal dc bias source has a range of 0 V to  $\pm 100$  V with 1 mV resolution on the most sensitive range. Various measurement parameters for C-V and C-t measurements—hold time (bias pulse width) and delay time (measurement interval)—can be manually set from the front panel. Or these parameters can be set under program control via the HP-IB. Settable range for C-t measurement interval is 10 ms to 32s with a best case resolution of 10  $\mu$ s. If an external pulse generator is used, however, measurement intervals as short as 10  $\mu$ s can be set. Up to 9999 readings can be set for a C-t measurement. These capabilities make it possible for the HP 4280A to measure the C-t characteristics of virtually any device.

#### High Speed C-t Measurement

The HP 4280A has a special sampling integration technique for measurement intervals as short as 10  $\mu$ s using an external pulse generator, such as the HP 8112A or 8160A, to provide the bias pulse. Short measurement interval makes the HP 4280A applicable to deep level transient spectroscopy (DLTS) measurements, commonly used to analyze physical characteristics of semiconductors.

#### Precision, High Resolution Measurements

The HP 4280A measures capacitances up to 1.900 nF, over three ranges, with 0.001 pF resolution on the most sensitive range. Conductance up to 12 mS can be measured with 10  $\mu$ S maximum resolution.

C and G measurements are made at 1 MHz. AC signal level is selectable between 10 mVrms or 30 mVrms, suitable for semiconductor measurements. Basic measurement accuracy is 0.1%. Maximum display resolution is 4½ digits. With Option 001, however, display resolution for capacitance is 5½ digits.

The accuracy and resolution of the HP 4280A satisfy the stringent requirements of laboratory and R and D measurements, which require the detection of minute changes in device characteristics.

#### Probed Measurements On Wafers

HP 4280A has an automatic error correction function that makes it possible to use test leads up to 5 m long (HP P/N (8120-4195).

The HP 4280A can measure either floating or grounded devices. Thus, the HP 4280A can be connected to a wafer prober and still provide stable, accurate C and G measurements.

#### Easy, Low Cost Systemization

HP-IB is standard on the HP 4280A. So, a process evaluation system or a lab automation system capable of evaluating the physical characteristics of semiconductor devices can be easily constructed.

The HP 4280A is equipped with analog outputs to allow users to plot device characteristics on an X-Y recorder or large screen display.

#### Specifications (refer to data sheet to complete specifications)

##### Measurement functions: C, C-V and C-t

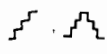
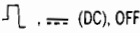
Function		Available Internal dc Bias Function
Basic Function	Selection	
C	C only, G only C-G only	OFF, --- (DC)
C-V	C-V G-V C & G-V	
C-t	C-t G-t C & G-t	 . --- (DC), OFF

#### C Measurement

##### Test signal

**Frequency:** 1 MHz  $\pm 0.01\%$

**OSC level:** 30 mVrms or 10 mVrms  $\pm 10\%$

**Measurement terminals:** two-terminal-pair configuration (High, Low and Guard).

**Connection mode:** sets connection configuration between DUT (floating/grounded) and measurement circuit.

**Ranging:** auto or manual

##### Error compensation

**Cable length:** 0 m, 1 m or 0-5 m. The standard cable (HP P/N 8120-4195) up to 5 m can be internally compensated.

**Zero open:** compensate stray capacitance and conductance at the test fixture.

**External error compensation:** compensate errors by external computer to eliminate other error factors not listed above.

**Measurement speed:** FAST, MED or SLOW

**Trigger:** Internal, External or Hold/Manual

**Internal dc bias mode:** OFF or --- (DC)

### Measurement Range/Resolution/Accuracy

Range <sup>1</sup>	Resolution <sup>2</sup>	Max. Display <sup>3</sup>	Accuracy <sup>4</sup> ±(% of rdg + counts)	
			OSC: 30 mV	OSC: 10 mV
10 pF/100 μS	0.001 pF 0.01 μS	19,000 pF 120.00 μS	±(0.1% + 5) ±(0.2% + 5)	±(0.2% + 5) ±(0.3% + 5)
100 pF/1 mS	0.01 pF 0.1 μS	190.00 pF 1.2000 mS	±(0.1% + 3) ±(0.2% + 3)	±(0.2% + 3) ±(0.3% + 3)
1 nF/10 mS <sup>5</sup>	0.1 pF 0.001 mS	1.9000 nF 12.000 mS	±(0.1% + 3) ±(1.2% + 3)	±(0.2% + 3) ±(1.2% + 3)

<sup>1</sup> 100 pF/1 mS and 1 nF/10 mS ranges only in grounded measurement.

<sup>2</sup> When measurement speed is set to FAST (10 mV/30 mV) or MED (10 mV), resolution and Max. display become 1 digit less (3 1/2 digit display).

<sup>3</sup> Approx. 50 pF at 100 pF/1 mS range and 1.76 nF at 1 nF/10 mS range in grounded measurement. Error correction to offset residuals will reduce maximum value which can be measured.

<sup>4</sup> Accuracy is specified at UNKNOWN terminals and at the end of HP 16082A Test Leads (1 m) after warm-up ≥30 min., at temperature 23°C ±5°C, zero open calibration is performed, and CORRECTION is enabled. Front panel settings are C-G, FLOATING and 0 m or 1 m (CABLE LENGTH). Some errors will be added at other settings (refer to data sheet). C accuracy is specified when D < 0.05 and G accuracy is specified when counts of C < 1/100 of range. Error double at 0°C-55°C.

<sup>5</sup> Add 0.1% of rdg for C and 0.2% of rdg for G when HP 16082A is used.

### C-V Measurement

**Function:** measures C-V, G-V or C & G-V characteristics using internal staircase bias.

**Measurement speed:** FAST, MED or SLOW

### C-t Measurement

**Function:** measures C-t, G-t or C & G-t characteristics using internal and/or external pulse bias source.





**Internal measurement mode:** Burst or Sampling Mode automatically selected.

**Burst mode:** apply one pulse then make repetitive measurement with specified time interval between measurements.

**Sampling mode:** repeated pulse with single samples between pulses. Delay between application of measure voltage and sample can be specified.

**Measurement speed:** FAST or MED

### DC Bias Source

**Output Mode:** , , ,  (DC) or OFF

**Output Voltage Range/Resolution/Accuracy**

Voltage Range	Resolution	Accuracy <sup>*</sup> ±(% of setting + volts)
±1.999 V	1 mV	±(0.2% + 0.01 V)
±19.99 V	10 mV	±(0.1% + 0.02 V)
±100.0 V	100 mV	±(0.1% + 0.1 V)

<sup>\*</sup>at 23°C ±5°C, at 0°C -55°C error doubles

### Staircase Sweep Parameter Settings (C-V Basic Function Only)

**Start/stop voltage:** 0 V-±100 V (max. 1 mV resolution)

**Step voltage:** 0 V-200 V (max. 1 mV resolution)

**Hold/step delay time (th/td):** 3 ms-650s (max. 1 ms resolution)

### Pulse Bias Parameter Settings (C-t basic function only)

**DC/pulse/measurement voltage:** 0 V-±100 V (max. 1 mV resolution)

**Number of readings:** 1-9999

**Hold time (th):** max. 10 μs resolution

**Internal bias:** 10 ms-32 s

**Ext bias slow:** 50 μs-32 s

**Ext bias fast:** 10 μs-32 s

**Delay time (td):** 10 μs-32 s (max. 10 μs resolution)

### Burst Mode

Function	Meas. Speed	Block Mode	Non Block Mode	
			Data Format	
			Binary	ASCII
C-t G-t	FAST	10 ms-32 s	20 ms-32 s	150 ms-32 s
	MED	50 ms-32 s		200 ms-32 s
C & G-t	FAST			
	MED	100 ms-32 s	250 ms-32 s	

### Sampling Mode

**Ext bias slow:** 200 μs-5 s

**Ext bias fast:** 10 μs-5 s

**Math functions:** displays measured C/G values as differential values (Δ), % ratio (%) or differential % (Δ%) of the reference value.

### Other

**HP-IB:** not just IEEE-488, but the hardware, documentation and support that delivers the shortest path to a measurement system.

**Data output format:** ASCII or Binary

**Block mode output:** can make C-V/t characteristics measurement and store measured data (C-V/t or G-V/t Function: 680 data, C & G-V/t Function: 400 data) into the internal data buffer. Then, packed data can be output.

### Recorder Output

**Output voltage:** ±10 V for C, G and V/t data

**Accuracy:** ±(% of output voltage + V)

**C or G:** ±(0.5% + 20 mV)

**V or t:** ±(0.15% + 40 mV)

**Self test:** verifies normal measurement operations (not including calibration)

### Options

**Option 001:** High Resolution Offset Capacitance Measurement

**Function:** increase C measurement resolutions by one digit with offset reference value.

**C offset range:** 0 pF-1023 pF (1 pF increment). C offset value can be set by measured data or numeric key.

### General Specifications

**Operating temperature range:** 0°C to 55°C; 95% RH at 40°C

**Power requirements:** 100/120/220 V ±10%, 240 V + 5% - 10%; 48 to 66 Hz; 140 V A max.

**Dimensions:** 426 mm W x 177 mm H x 498 mm D (16.5" x 7" x 19.5")

**Weight:** 15.3 kg (33.7 lb)

### Accessories Furnished

**HP 16080A:** Direct Coupled Test Fixture

### Reference Data

#### Measurement Time

MEAS SPEED	Measurement Function					
	C-G		C		G	
FAST	30	(70)	10	(30)	10	(30)
MED	70	(110)	40	(60)	35	(55)
SLOW	400	(440)	270	(290)	220	(240)

When measured values are displayed on the front panel and the recorder outputs are used, measurement times in parentheses apply.

**Residual L-R compensation:** error compensation for residual L-R (max. 19 μH/190 Ω) is available using an external controller.

### Internal DC Characteristics of High and Low Unknown Terminals (Without DC Bias)

**Maximum offset voltage:** ±1 mV

**Maximum allowable current:** 100 mA

### Internal DC Bias

**Settling time (99.9% of final value):** 0.05 × voltage swing (V) + 1.7 (ms)

**Maximum output current:** ±6 mA

**Hold time/step delay time/th/td:** 0.02% (basic accuracy)

**Response time of the EXT SLOW bias circuit (99.9% of final value):** 100 μs

### Option 001

**C offset accuracy:** ±(2% of reference value + 0.5 pF) can be compensated by CORRECTION ENABLE key.

### Ordering Information

**HP 16081A Test Leads,** 2 m double shielded, BNC

**HP 16082A Test Leads,** 1 m, BNC

**HP 16083A Pulse Bias Noise Clipper**

### Price

\$760 

\$260 

\$415

### HP 4280A 1 MHz C Meter/C-V Plotter

**\$11600**

**Opt. 001:** C-High Resolution (not field installable)

\$440

**Opt. W30:** Extended Repair Service. See Page 723.

 Fast-Ship product — see page 732.

# SEMICONDUCTOR TEST EQUIPMENT

## Circuit/Device Modeling IC-CAP

- Minimize design iteration cycle
- Optimize the IC performance
- Create new device models and circuit macromodels with ease

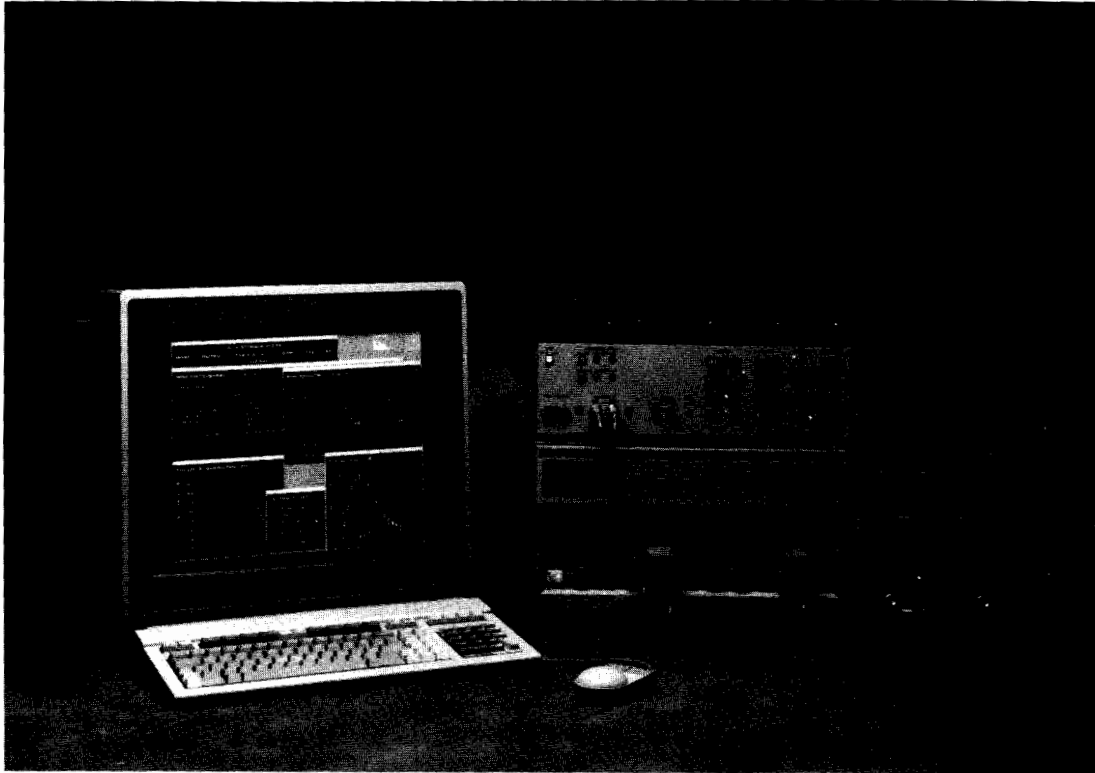

IC-CAP



### IC-CAP Circuit/Device Modeling Software

#### New Approach To Modeling

Over the last decade the semiconductor technology has gone through rapid advancements resulting in dramatic improvement in the performance of IC's. State-of-the-art IC technologies use devices that require careful attention to modeling the parasitics and second order effects. Parasitics must be included as sub-circuits formed around the transistors. Analytically solving a set of device equations is inadequate for most of the semiconductor technologies.

#### Sub-circuit Characterization and Modeling

The success of IC an technology is in its ability to achieve the desired performance while maintaining high product yield. Accurate prediction of the performance of an IC relies on the simulation models used and the capability to accurately extract device parameter as well as sub-circuit components values for these models.

#### Simulating a Device or Sub-circuit

IC-CAP provides a direct link to SPICE circuit simulator through an open interface and uses it for analysis and optimization of device or sub-circuit performance. Direct use of SPICE also eliminates any discrepancy between modeling and simulation tools.

#### Extracting Parameters

IC-CAP's powerful extraction, optimization and advanced utilities coupled with SPICE simulator will help you generate the most accurate device parameters or circuit element values for your designs.

#### Macromodeling

Macromodels are simplified versions of complex circuits that are used for efficient simulation of circuits or systems. The user describes the topology of the macromodel in the form of a sub-circuit to IC-CAP. IC-CAP performs the analysis and measurements based on the inputs and finds the most optimum component or device parameter values for the best performance.

#### Statistical Modeling

Through support of the HP 4062UX process control system, IC-CAP is used to collect large volume of model parameter data. Statistically significant models to cover best/worst and nominal case corners are obtained from this data. IC-CAP's batch-mode operation is designed to facilitate statistical modeling.

#### Complete Characterization Solution with TECAP and IC-CAP

TECAP and IC-CAP cover a wide range of characterization needs for the semiconductor industry. All TECAP measurement and extraction files are compatible with IC-CAP. This allows a smooth migration path for present and the future TECAP users as they move from single device extraction to device and sub-circuit modeling.



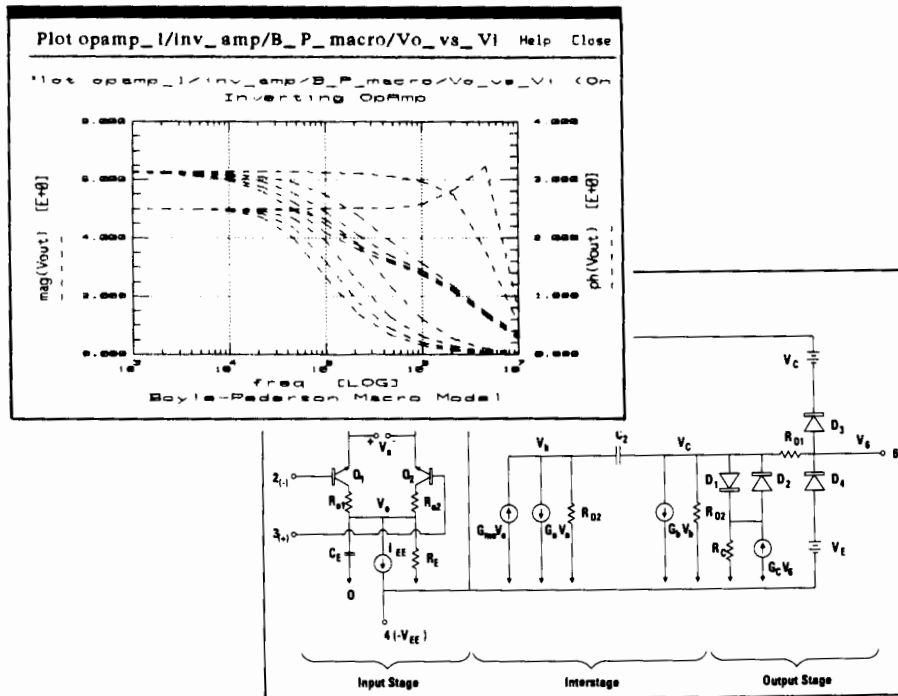

IC-CAP circuit-modeling capability is a valuable aid in macromodel development

#### IC-CAP Utilities

IC-CAP's transforms provide the user with the ability to optimize model parameters over any transformation performed on the data. Typical transforms include derivatives, algebraic and trigonometric and arithmetic operation that are contained in a powerful functions library. IC-CAP also comes with graphical analysis and calculation capabilities for real time analysis of the measured data.

#### Networking To Design Environment

Running under HP-UX operating system, IC-CAP can easily be networked to your existing design environment. This enables designers to easily access model libraries. HP-UX also offers the advantage of easy access to industry standard database systems and analysis packages including TekBase,<sup>1</sup> Oracle,<sup>2</sup> Informix<sup>3</sup> and RS/1.<sup>4</sup>

#### Training and Support

HP offers a free training for every purchase of one of the IC-CAP modeling systems. IC-CAP is covered with HP's Basic/ResponseLine support services. We recommend subscription to Software Material Update to stay current with the IC-CAP software.

#### IC-CAP Framework

Configuring a modeling system requires the IC-CAP framework. It must be ordered with all new systems. Adding new models or measurement drivers for an existing system requires the purchase of the particular module only. For example you can start with MOS modeling system, and later on add Bipolar models and ac measurement drivers to address the BiCMOS characterization needs.

#### IC-CAP Modeling System Configuration

IC-CAP is the product of choice to perform characterization and modeling on device and sub-circuit level for various technologies. IC-CAP runs on HP 9000 Series 300 workstations under HP-UX operating system.

<sup>1</sup>TekBase is a trademark of Leading Edge Technology

<sup>2</sup>Oracle is a trademark of Oracle Corporation

<sup>3</sup>Informix is a trademark of Informix Inc

<sup>4</sup>RS/1 is a trademark of BBN Corporation

#### MOS Modeling System

- E3300A IC-CAP Framework
- E3301A DC measurement drivers
- E3302A LCRZ Measurement drivers
- E3304A Time Domain (TD) driver
- E3305A Analysis Module
- E3306A SPICE MOS model parameter extraction
- E3307A SPICE BSIM model parameter extraction

Note: IC-CAP supports both BSIM and levels 2 and 3 of UCB SPICE models. You have the option to select either one or both. We also recommend the E3304A in order to characterize and validate transient performance of selected circuits.

#### Bipolar Modeling System

- E3300A IC-CAP Framework
- E3301A DC measurement drivers
- E3302A LCRZ measurement Drivers
- E3303A AC measurement drivers
- E3304A Time domain (TD) driver
- E3305A Analysis Module
- E3308A SPICE Bipolar model parameter extraction

#### GaAs Modeling System

- E3300A IC-CAP Framework
- E3301A DC measurement drivers
- E3302A LCRZ measurement Drivers
- E3303A AC measurement drivers
- E3304A Time domain (TD) driver
- E3305A Analysis Module
- E3309A GaAs model parameter extraction Includes Raytheon and Curtiss models

#### Ordering Information

Please call your local HP Sales office (see page 737) for a data sheet, prices and application assistance.

# SEMICONDUCTOR TEST EQUIPMENT

## Device Modeling Software TECAP Characterization System

- Shortens IC design time
- Improves circuit designs
- Lowers chip costs
- Maximizes yields
- Accurate circuit simulations
- Device ac and dc measurements

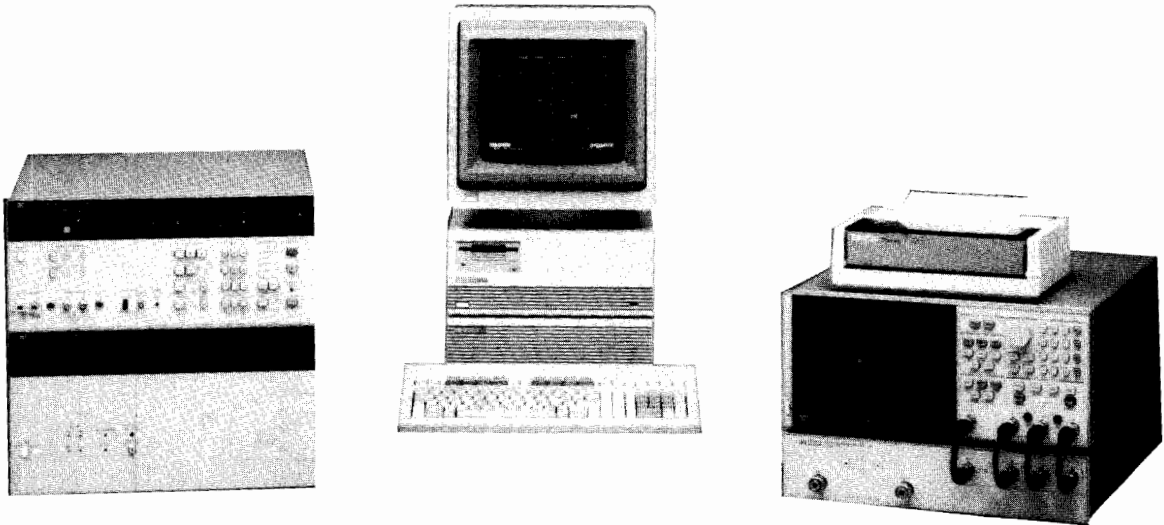

TECAP software is fully compatible with a wide range of standard HP-IB instrumentation.

### TECAP Lets You Design New IC's in Less Time - With Less Cost

The TECAP Characterization System shortens your IC design cycles and lowers design costs. TECAP - Transistor Electrical Characterization and Analysis Program - provides fast, reliable analysis of device behavior. Model parameters generated with the TECAP system will improve your circuit simulation and IC designs.

### TECAP Extracts Model Parameters in Seconds

TECAP software can automatically extract UCB Level 1, 2, 3, 4 MOS, UCB Bipolar, or GaAs model parameters in seconds. These models can simulate second-order effects, such as channel-length modulation, and offer direct compatibility with the UCB SPICE circuit simulator developed at the University of California, Berkeley.

The TECAP system can also extract parameters for your new transistor models. Newly implemented models have the same parameter extraction, optimization, and simulation capabilities as standard TECAP models. You can even add a custom extraction module to the program to fully automate parameter extraction for your model.

### Best/Worst Case Modeling

Using TECAP's statistical tools, you can accurately determine worst case performance of your process using those dominant parameters. TECAP gives you the vehicle to construct worst case models which will allow you to increase the performance of your process with minimal process development and lower cost.

### Develop and Understand New Device Models

You can implement your own transistor models into TECAP to be completely compatible with proprietary circuit simulation programs or emerging new semiconductor technologies. You can use the versatile simulation tools to develop and to test new model equations.

### TECAP Is Easy to Use

TECAP provides both ease-of-use for the occasional user and advanced features and capabilities for the expert user.

To measure a device, extract model parameters, or simulate device performance, you select the appropriate command. If the system needs more information from you, it will supply a diagram or table for you to edit. Every table is already furnished with default values or configurations. The table entry method allows you to have immediate access to all of your characterization routines so you can use the design tools more productively.

### Configure System Hardware to Satisfy Your Price and Performance Requirements

The TECAP system works with a wide range of standard Hewlett-Packard computers and HP-IB instrumentation, allowing you to choose the equipment which meets your exact needs. TECAP supports the HP 4145B and HP 8753B, as well as newer instruments

such as the HP 4142B, HP 8720A, and HP 4284A. You can build an entry-level system to start with. Then, as your requirements expand, you can add the latest in high performance measurement tools to fit your changing situation.

### TECAP Software Specifications

**Operating system:** Pascal Workstation language system, Version 3.22.

**Measurement:** voltage, current, capacitance, and 2-port ac parameters vs. bias and frequency.

### Model Parameter Generation

#### Extraction:

- direct extraction from measured data
- predefined routines for automatic extraction
- interactive parameter extraction mode
- user-definable extraction routines

#### Optimization:

- numerical fine tuning of extracted parameters using integrated SPICE-like simulator for highly accurate fits
- compatible with user defined models
- Levenberg-Marquardt algorithm for nonlinear, least-squares fit
- constrained optimization

**Simulation:** voltage, current, capacitance, and 2-port ac parameters vs. bias and frequency.

#### Available models:

- UCB MOS Levels 1, 2, 3 and 4 (BSIM)
- UCB bipolar (Gummel-Poon, Ebers-Moll)
- Curtice GaAs MESFET Levels 1 (quadratic) and 2 (cubic)
- UCB GaAs MESFET
- Yaeger-Dutton GaAs HEMT
- UCB JFET
- Diode
- PN Junction Capacitance
- MOS Gate Capacitance
- Classical MOS
- Up to 7 user-definable models

### TECAP data sheets

MOS Modeling with TECAP - publication 5956-4220

BSIM Modeling with TECAP - publication 02-5956-4217

GaAs Modeling with TECAP - publication 02-5956-4216

UCB Bipolar Modeling - publication 5956-4218

### Ordering Information

Please call your local HP sales office listed on page 737 for a data sheet, prices, or applications assistance.

- Substantially reduce parametric test development time.
- Standardize on IC-MS for all your test development and execution needs.
- Generate test plans for use in R&D and production

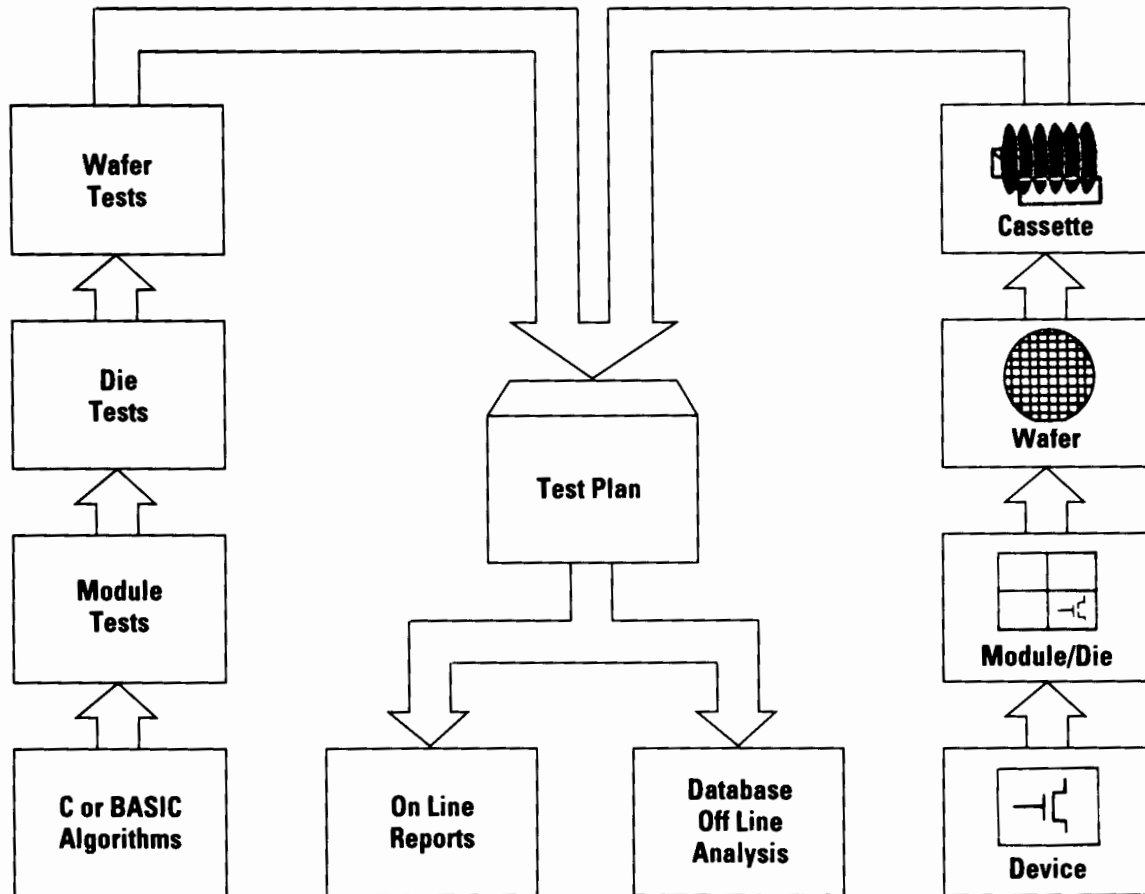

IC-MS is the ideal test manager for development and production environment

### Impact of VLSI on Parametric Testing

Demands of a rapidly changing VLSI environment have placed great emphasis on a highly flexible and automated manufacturing process. This in turn has led to the evolution of high-speed parametric testers with intelligent instrumentation to perform thousands of measurements routinely. Different phases of VLSI development require using special test structures and corresponding test plans to provide the final evaluation of the myriad interactions between materials and processing that occur during the IC manufacturing sequence.

### A Powerful Test Shell for Process Monitoring/Development Needs

IC-MS is implemented on the HP 4062UX semiconductor process control system. It is a test shell that will help you generate and execute parametric test plans with ease and with the least amount of programming. Test plans generated by the IC-MS are used throughout the IC manufacturing process from development to production process monitoring.

### IC-MS in Development Environment

Semiconductor technology development process requires a sophisticated parametric test environment in order to gain maximum information from the experimental wafer lots. In such an environment, test plans are constantly generated and modified to meet the demands of increasingly complex tests. Designing a test plan with IC-MS involves two steps: defining the physical structures, and defining the algorithms used to test these structures. The only programming involved

is creating test algorithms. Once the reference information about the physical structure of the wafer is entered, generating a test plan involves sequencing, devices and dies and test algorithms using the X-window based user interface. This approach offers the maximum flexibility which is the primary requirement of testing at this stage.

### IC-MS in Production Environment

IC production environment requires a parametric test shell that is easy-to-operate and generates robust test plans. IC-MS takes care of all the non-application specific portions of the software including the user interface. It includes many powerful features to allow for secure and error-free operation in the production mode. IC-MS is optimized for throughput and allows for maximum use of the test hardware.

### Powerful Turnkey Features

IC-MS provides many unique features to simplify the process of developing a parametric test plan. These features include, on-line reporting capability for quick reports on the status of your process, open interface to allow automatic entry of the reference data, open access to test plan data for easy integration into the popular databases. User-written algorithms are supported in both HP BASIC/UX and C.

### Ordering Information

IC-MS software product number is E3330A. This product is covered by HP's Basic/ResponseLine support services. We recommend subscription to Software Material Update Service in order to keep current with the IC-MS enhancements.

# BOARD TEST SYSTEMS

## Board Test Introduction

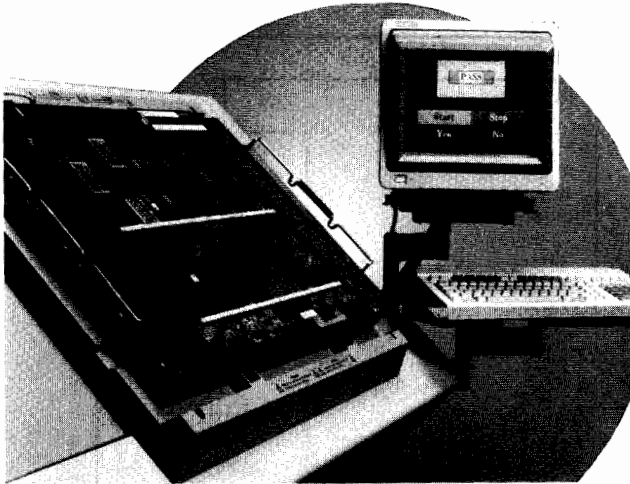

Technological advances and increased worldwide competition place ever-increasing demands on production managers to cut costs, increase productivity, and improve product quality. The use of advanced technologies, including surface-mount devices (SMDs), application-specific integrated circuits (ASICs), and VLSI circuits, give the manufacturer capability, reliability and cost advantages. They also present a unique set of process and test related problems. Automatic test equipment to solve these problems is no longer a luxury; it is a necessity.

Hewlett-Packard, an innovator in the design and use of advanced technologies, provides a full line of affordable board test systems to meet the diverse needs of the electronics manufacturing industry. From the low cost HP 3065ST Standard Technologies in-circuit tester to the HP 3070 AT-Series combinational test systems, Hewlett-Packard has a system to meet your specific testing requirements.

### The Board Test Advantage

In the manufacturing process, board test is the first stage where the entire fault spectrum, from defective components to process faults, can be detected. Since each production operation is unique, the board test system must have the flexibility to meet your future requirements as well as your current needs. In choosing a test system, the four major factors to consider are software, in-circuit/combinational testing capability, fixturing solutions, and reliability/support. Each is of equal importance, similar to the legs of a table. All the legs must be of equal length and long enough to keep the tabletop they support at a usable level. To fall short in any area will throw the entire system out of balance, reducing its overall effectiveness.

### In-circuit/Combinational Testing

Hewlett-Packard offers analog and digital testing capabilities in both in-circuit and combinational board test systems. Hewlett-Packard's analog in-circuit testing capabilities have been the industry standard for over 11 years. In digital in-circuit testing, the HP vector processing unit (VPU) makes the current RAM-behind-the-pins technique for pattern application obsolete. With the VPU, the theoretical limit to the pattern depth, without reload or dead time, is approximately 535 million test patterns.

Combinational testing has traditionally been defined as the use of both in-circuit and functional test techniques residing in the same system. This implies that it is merely the sum of the two techniques, each with its advantages and disadvantages. However, combinational testing as a whole can be much greater than the sum of the parts. The key

to accomplishing this is integration. It requires a single architecture, common hardware, and a flexible software environment to reach its full potential. Every HP combinational test system uses integrated hardware and software resources to provide unsurpassed test coverage and flexibility for analog, digital, and mixed-signal circuits.

### Software Resources

Hardware features and specifications are most often used as points of comparison between board test systems. However, cost of ownership and return on investment depend more on the software resources of the systems. Test program generation times, fixture development, and fault diagnostics are major contributors to the ongoing costs of the production test department. HP board test systems provide software to make the testing process easier, from start to finish.

HP board test systems provide software to automatically transfer valuable programming information from virtually any CAD and CAE system into menu-driven board forms.

Next, the HP Integrated Program Generator (HP IPG) automatically produces a test program, in which typically over 90% of the tests work the first time. This includes shorts, opens, digital tests using Hewlett-Packard's 6500 part digital library, and 6-wire guarded analog tests. CAE data is used to generate tests for complex devices such as ASICs.

HP Color Graphical Debug allows programmers to easily debug both analog and digital tests with histograms and built-in logic analyzer-like displays. It provides softkey driven interactive control of all parameters, highlighting failing responses.

All of these test development tools, and more, are managed by the HP IPG Test Consultant, a menu-driven, mouse-supported interface. A programmer's actions are based on recognition, not recollection, with desired actions selected from the available pull-down menus. The software relieves the programmers of time-consuming tasks such as file management, revision archiving, and program scheduling. In addition, programmers choose the levels of flexibility and automation to best match their expertise.

### Fixturing Solutions

HP offers a full line of mechanical and vacuum-actuated test fixtures and accessories to maximize system performance. In 1986, the HP SimPlate Series was introduced, offering a 10:1 reduction in probing errors over the conventional two-plate design. With the introduction of the HP 3070 family in early 1989, additional vacuum-actuated fixtures and a mechanical fixture and cassette were introduced. These fixtures provide dual-sided, and dual-stage probing, short wire lengths, and improved contact reliability. The mechanical fixturing system readily integrates into automated test environments.

The HP Express Fixture Software automatically designs the test fixture, minimizing wire lengths and close-centered probes, selecting optimum probe locations, and documenting the fixture construction process. The software also generates files to support automatic drilling, wiring, and receptacle installation of the fixture.

### Reliability/Support

Since 1983, the HP 3065 testers have been the most reliable systems on the market, but now they have been surpassed by the HP 3070 family, with an MTBF of over 2300 hours. This reliability was achieved through the extensive use of SMT and HP-designed integrated circuits and reduced numbers of electrical parts, cables, connectors and mechanical parts. Improved diagnostics and board-level repair give the system an MTTR of 2 hours. The standard warranty on the HP 3070 System is one year parts and labor.

With over a hundred sales and service offices worldwide, trained HP personnel are there when you need them. Expert programming help is available by phone from the HP Response Center, or locally from over 45 offices with trained HP Systems Engineers. In addition, HP qualifies, trains, and supports a worldwide network of Value-added Suppliers. These suppliers provide fast, local, competitively-priced fixturing and programming services.

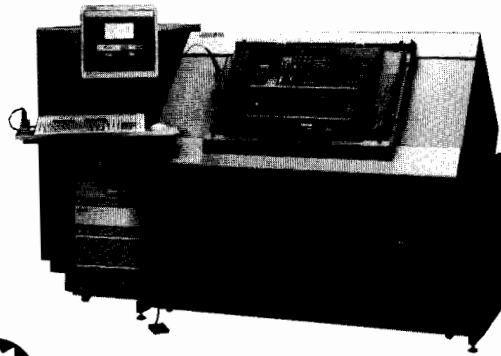

HP 3073 Advanced In-Circuit Board Test System



### HP 3073 Board Test System

#### Advanced In-circuit Testing with Full Upgradability

The HP 3073 board test system is an advanced in-circuit board test system used for testing digital, analog, and mixed-signal circuits. The HP 3073 system is fully upgradable to the HP 3070 Combinational or HP 3070 SMT test system, with complete software, fixture, and test program compatibility.

The HP 3073 system not only provides in-circuit testing capabilities to test today's most difficult test problems, but also provides the insurance that combinational testing and automation capabilities can be added as needed, preserving previous investments in hardware and software.

The HP 3073 system will easily detect shorts, opens, and other manufacturing faults, such as bad components, missing parts, incorrect parts, and backward parts. The HP 3073 system tests complex technologies such as ASICs, VLSI circuits and microprocessors, and tests large boards up to 2592 nodes.

#### Analog and Mixed-Signal Testing

HP analog testing capabilities have set the standard in the electronics industry for many years. These proven analog testing techniques, such as the automatic generation of 2,3,4 and 6-wire guarded in-circuit tests, built-in sources and detectors, and standard HP-IB (IEEE 488) interface for additional analog functional test instrumentation, are all part of the HP 3073 system. Additionally the program generator has been greatly improved through advanced analog simulation techniques to nearly eliminate the need for analog debug. Synchronization of the analog and digital subsystems is included for coordinated mixed-signal testing.

#### Digital Testing

With a standard digital test library of over 5500 TTL, CMOS, ECL, SMT, ACT, and VLSI devices, most digital tests are generated automatically. Every test generated by the HP 3073 system is analyzed by the HP Safeguard In-circuit Analysis software to minimize the potential for device damage in backdriving testing environments.

The Hybrid Plus-6 pin electronics of the HP 3073 system provide  $\pm 5$ ns typical edge placement accuracy resulting in repeatable, stable, transportable digital tests. In addition, each Hybrid Plus-6 pin can provide 20 MHz clock signals, up to 6 MHz pattern application rate and can each be independently programmed for different drive/receive levels, slew rates, edge placement, and pull up/pull down loads for maximum flexibility when testing large, complex digital devices. For complex devices requiring large sets of vectors, the HP 3073 patented Vector Processing Unit (VPU) architecture uses a combination of software and hardware for the automatic compression, distributed storage, and application of very deep vector sequences. HP 3073 systems can reconstruct long test sequences of millions of test vectors.

#### Automatic Program Generation Integrated Program Generator

The HP 3073 system minimizes the test development cycle with the HP Integrated Program Generator (HP IPG), which automatically generates shorts and opens tests as well as both digital and analog tests. Typically over 90% of the generated tests provide accurate and repeatable results the first time without debug.

#### HP IPG Test Consultant

With HP IPG Test Consultant, programmers are relieved of time-consuming tasks such as file management, revision archiving, and program scheduling. With a color, menu-driven, mouse-supported, easy-to-use interface, HP IPG Test Consultant manages these tasks as well as guides the programmer through the test development cycle.

#### Upgradability

The architecture of the HP 3073 system is designed to solve test problems into the 21st century. Beginning as an advanced in-circuit test system, the HP 3073 can grow into a full combinational test system with complete software, fixture, and test program compatibility.

If integration into an automated environment is needed, the HP Express Fixturing System can be added to the HP 3073 system. The HP Express Fixturing System also solves difficult surface mount technology problems by providing a mechanically-actuated fixture for dual-sided, dual-stage probing, as well as minimized wire lengths.

This compatibility and upgradability ensures that investments made with an HP 3073 will continue to payoff in the future even as testing and manufacturing needs change and grow.

#### State-of-the-art Fixturing

HP Express Fixture Software automatically designs the HP Simple Plate Express Fixture for the board to be tested. This software minimizes wire lengths, minimizes close-centered probes and selects probing locations to reduce areas of high probe density. Each fixture is documented with clear concise instructions for fixture construction, resulting in higher fixture quality and reduced costs.

During fixture design, the software creates information files to support automated drilling, and semi-automated wire-wrapping saving significant time and money. After the fixture is completed, the HP fixture verification software is used to ensure it was properly assembled.

#### Production Analysis Tools

After a test is released to production, the HP Pushbutton Q-STATS quality management software assists in detecting production process problems. The software uses SQC techniques on actual test data to generate color graphical displays of measurement histograms, production statistics, and test failure reports, at the touch of a button.

As the need for SQC analysis grows, the HP 3073 can be integrated into the HP Q-STAR Network, providing access to HP PR PLUS paperless repair management software and to the HP Q-STATS II advanced quality management system.

#### Reliability/Support

The HP 3073 system exceeds the board test industry reliability standards previously held by the HP 3065 test system. The HP 3073 design, using SMT and HP integrated circuits, proves an MTBF of over 2300 hours. The new technologies reduce the number of electronic and mechanical parts required, ensuring unsurpassed system reliability.

Hewlett-Packard has over 100 board test service offices worldwide, and along with the HP Application Engineering Organization and HP Project Centers, can provide complete solutions to your application, hardware, and software needs throughout the world.

#### HP 3073 Board Test System

For more information on the HP 3073 board test system, contact your local Hewlett-Packard Sales and Service office. See page 737

#### Ordering Information

HP 3073 prices start at

#### Price

\$205,000

# BOARD TEST SYSTEMS

## HP 3070 Board Test Family

- In-circuit testers
- Combinational testers
- Surface mount technology testers

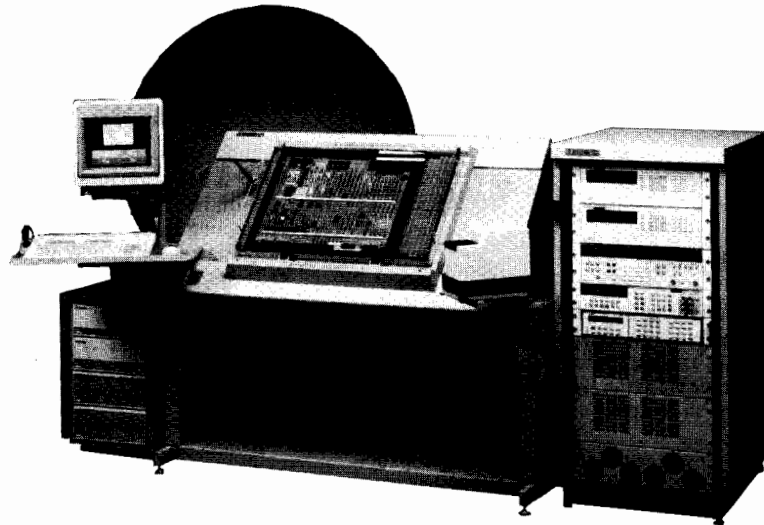

HP 3070 AT-Series

### HP 3070 Series Board Test Family

The HP 3070 Series board test systems combine high-performance functional and in-circuit test capabilities to solve the most complex test problems faced by the electronics manufacturing industry. All HP 3070 systems provide a completely integrated set of powerful resources for testing digital, analog, and mixed-signal circuits, from surface-mounted, application-specific integrated circuits to state-of-the-art microprocessors. With the latest computational and measurement technologies, the HP 3070 family has the flexibility to effectively test the new technologies you face today . . . and tomorrow.

The family of test systems consists of the HP 3070 AT-Series combinational testers and the HP 3070 SMT-Series testers, which combine the power of the HP 3070 AT-Series test systems with integral mechanical fixtures that meet the needs of automation and surface-mount technology testing.

#### Flexible Architecture

The HP 3070 system architecture is designed to solve test problems into the 21st century. The testhead uses a parallel architecture that supports up to four expansion modules. Each module has its own analog and digital control systems and provides up to 648 test nodes. For large node count boards, the modules operate synchronously, providing up to 2,592 total nodes for the HP 3070 AT-Series and HP 3073 ST-Series, and 1,296 for the HP SMT-Series.

HP HybridPlus pin electronics in each module provide independently programmable control of tester resources on a pin-by-pin basis. Each pin can be used for functional or in-circuit, digital or analog testing. In addition, each pin provides 20 MHz clock signals and access to functional test instrumentation. Drive and receive levels, slew rates, edge placement, pull up/pull down loads, and shorts/opens thresholds are also independently programmable on each pin. Digital tests can be applied at up to 6 (HP 3073) or 12.5 (HP 3070) million patterns per second with typical edge-placement accuracy of  $\pm 5$  ns.

#### Analog Testing

HP analog testing capabilities are the standard in the electronics industry. These field-proven analog testing techniques, such as the automatic generation of 2, 3, 4, and 6-wire guarded in-circuit tests, built-in sources and detectors, and standard HP-IB (IEEE 488) interface for additional analog functional test instrumentation, are retained in the HP 3070 system. Synchronization of the analog and digital subsystems is added for coordinated mixed-signal testing. In addition, the program generator has been greatly improved through advanced analog simulation techniques to nearly eliminate the need for analog debug.

#### Digital Testing

To meet the challenges of testing ASIC, SMT, and VLSI circuitry, test systems must provide better test development tools and improved testing techniques. The HP 3070 Series offers unsurpassed digital test capabilities for these new technologies.

#### Vector Processing Unit

Hewlett-Packard pioneered the vector processing unit (VPU) concept in the HP 3065 family, and it has been continually improved since that time. The VPU used for digital testing in the HP 3070 family makes obsolete the conventional RAM-behind-the-pins that is used in most other test systems today.

Using the conventional RAM method for pattern application to the DUT, each vector can be used only once before the RAM must be reloaded. Because today's devices require hundreds of thousands of test patterns, the RAM must be reloaded many times. This requires the tests to be segmented and the devices to be re-initialized each time, with dead cycles during reload.

The HP 3070 patented VPU architecture solves this reload problem. It uses a combination of software and hardware for the automatic compression, distributed storage, and application of very deep vector sequences. The theoretical limit to the pattern depth is approximately 535 million vectors before a reload is required.

#### Digital Test Capabilities

Because they use the VPU, HP 3070 Series systems can reconstruct long test sequences of millions of test vectors. These vectors can be applied at up to 6 (HP 3073) or 12.5 (HP 3070) million patterns per second with typical edge placement accuracy of  $\pm 5$  ns. Over 8000 programmable timing sets are available, and each one can be switched at any time.

Up to 576 independently programmable digital resources are available on the system, consisting of 288 drive channels and 288 receive channels. Synchronization to external clocks of up to 20 MHz (HP 3073) or 40 MHz (HP 3070) is provided via special clock pins. The standard HP HybridPlus pins provide 20 MHz capability.

#### Integrated Program Generator

The HP Integrated Program Generator (HP IPG), combined with a standard digital library of over 6500 TTL, CMOS, ECL, SMT, ACT, and VLSI devices, automatically generates the digital test program. Typically, over 90% of the generated tests work the first time without debug. HP IPG also provides analog and digital subsystem synchronization for coordinated mixed-signal testing by automatically generating shorts and open tests, and guarded 6-wire analog tests.

### HP Safeguard In-circuit Analysis

Every test generated by the HP 3070 system is analyzed by the HP Safeguard In-circuit Analysis software to minimize the potential for device damage in backdriving testing environments. As each test is created, the software analyzes device parameters such as package type, power dissipation, voltage overshoot, and overdrive currents. If unsafe backdrive conditions are detected, the programmer is notified. In addition, adequate cooldown times are automatically imposed for devices that are being overdriven repeatedly within the test. This is especially important when testing boards with large ASIC and VLSI devices that require many thousands of test vectors.

### Test Development

Test development is one of the most time-consuming activities in the manufacturing process. The HP 3070 Series test system provides the software tools needed to shorten your product development cycle.

### HP IPG Test Consultant

The HP IPG Test Consultant manages the test development on the HP 3070 Series test system. It is a color, menu-driven, mouse-supported, easy-to-use interface that guides the programmer through the test development cycle. Based on recognition, not recollection, HP IPG Test Consultant relieves programmers of the burden of remembering the next step. Actions are selected from available pull-down menus, and online help is available when needed. Programmers can choose levels of automation or flexibility, depending on their expertise with the HP 3070 Series.

At the same time, HP IPG Test Consultant relieves programmers of time-consuming tasks such as file management, revision archiving, and program scheduling. This allows them to focus on improving tests for their boards, not trying to remember what comes next.

### Board Topology Entry

The test development cycle begins by describing the board to the test system. Significant savings in time can be realized if mechanical information about the board (X-Y and connectivity data) can be retrieved from CAD systems. The HP 3070 Series systems come standard with a CAD format translator (CFT). CFT uses templates to structure the data in a format usable by the HP 3070 Series tester. It has templates for most commercial CAD systems and can be adapted for proprietary systems.

The board forms editor on the HP 3070 Series systems can be used to enrich the captured CAD data or to enter board descriptions manually. Board forms is a menu-driven editor for entering connectivity and parts information by filling in the blanks of pre-constructed forms.

HP 3070 Series systems capture, compare, and evaluate data created by any simulator and use that information in generating ASIC, cluster, and edge-connector tests. Simulated test patterns and timing information are transferred to the system via the HP Pattern Capture Format for custom test generation.

After the board topology is loaded in the HP 3070 Series systems, the HP Integrated Program Generator develops the test programs. Both in-circuit and functional tests are written in the same high-level languages, such as HP BT-BASIC and Vector Control Language (VCL).

### Fixture Development

HP Express Fixture Software automatically designs fixturing for the board to be tested. In addition to minimizing wire lengths, the software minimizes close-centered probes and selects probing locations to reduce areas of high probe density. Each fixture is documented with clear, concise instructions for fixture construction, resulting in higher fixture quality and reduced costs.

During fixture design, the software creates information files to support automated drilling, wiring, and receptacle installation, saving both time and money. After the fixture is completed, the HP fixture verification software is used to ensure it was properly assembled.

### Color Graphical Debug

Once the program is generated by HP IPG, typically 90% of the tests work the first time. For those that do not work, HP Color Graphical Debug displays both digital and analog tests using histograms and logic analyzer-type screens. It is softkey-driven for ease of use.



### HP 3070 AT-Series with programming station

The software provides interactive control of both digital and analog test parameters including edge placement, slew rates, guard points, drive/receive levels, sources/detectors, and more. Failing responses are highlighted in color. Probing for the debug process can be done through the fixture or via a handheld probe.

### Production Testing

After a test is released to production, the HP Pushbutton Q-STATS quality management software assists in detecting production process problems. The software uses SQC techniques on actual test data to generate color graphical displays of histograms, production reports, and failure reports, at the touch of a button.

As the need for SQC analysis grows, the HP 3070 Series family can be integrated into the HP Q-STAR Network, providing access to HP PR PLUS paperless repair management software and HP Q-STATS II advanced quality management software.

### Protect Your Investment

The HP 3070 Series family offers the flexibility and modularity to grow as your needs grow. It is supported by software, digital/analog combinational testing, fixturing solutions, and reliability/support.

The HP 3070 Series family exceeds the board test industry reliability standards previously held by the HP 3065 test system. The HP 3070 Series design, using SMT and HP integrated circuits, proves an MTBF of over 2300 hours. The new technologies reduce the number of electronic and mechanical parts required, ensuring unsurpassed system reliability.

When the HP 3070 Series system fails, its board-level repair strategy simplifies diagnostics and repair. Average mean-time-to-repair (MTTR) is less than two hours.

Hewlett-Packard has over 100 board test service offices, and along with the HP Application Engineering Organization (AEO) and Project Centers, can provide complete solutions to your application, hardware, and software needs throughout the world.

### HP 3070 Series Board Test Family

For more information on the HP 3070 board test family, contact your local Hewlett-Packard Sales and Service office. See Page 737

### Ordering Information

Prices depend on system configuration.	
HP 3070 AT-Series prices start at	\$297,100
HP 3070 SMT-Series prices start at	\$332,200
HP 3073 prices start at	\$205,000

# BOARD TEST SYSTEMS

## Testing Surface Mount Technology Boards HP 3070 SMT-Series

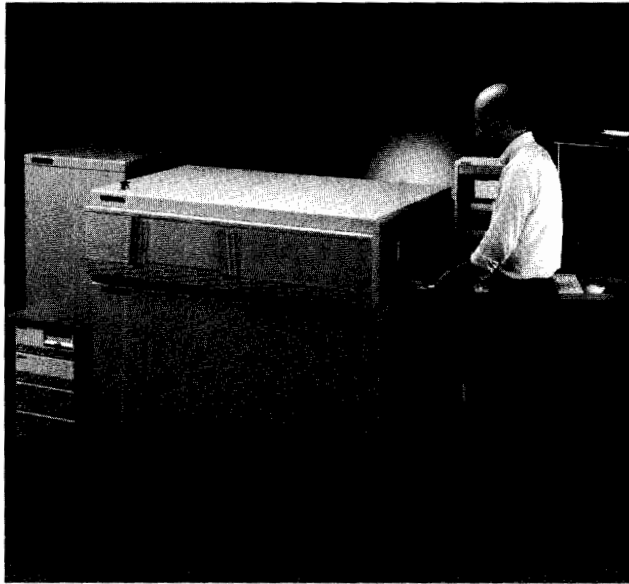

In the last five years, there have been rapid technological advances in the electronics industry. Device technologies like application-specific integrated circuits (ASICs) and VLSI circuitry, which were rarely used five years ago, now appear in the design of almost every PC board. However, the greatest impact on the electronics manufacturing industry has been the exponential growth of surface mount technology (SMT). SMT, ASICs and VLSI offer greater capabilities and flexibility in much smaller packages. Although they have cost and capability advantages, these new technologies also introduced a unique set of process and test related problems that your board test system must solve.

Using SMT in the design of PC assemblies allows higher device densities but results in reduced test pad target size, limited access to test nodes, and dual-sided component placement. Testing these densely packed circuits requires a board test system that has advanced SMT fixturing and test development tools. That system is the HP 3070 SMT-Series tester.

### Testing SMT PC Boards

The primary problems in testing SMT boards are the shortage of reliable probing points access for detailed diagnostics and the high component densities that reduce the size of the test pad to be probed. In an attempt to reduce board geometries even further, manufacturers are placing components on both sides of the PC assembly. This poses problems for both the test system and the design of the test fixturing.

Testing PC boards with limited access requires a combinational test system with the capability for both in-circuit and cluster functional testing for sections of the board where probe access is impossible. Automatic backtracing for accurate fault isolation within the cluster is also required. To lower the cost of cluster testing, the HP 3070 SMT-Series has an integrated program generator, library-generated backtrace trees, and HP Color Graphical Debug.

### SMT Fixturing

Surface mount technology has had a major impact on test fixture design. The conventional two-plate vacuum fixture design was adequate for through-hole technology that provided large test pads and single-sided access of every test node. Component densities, reduced access, dual-sided boards, and smaller probing targets have changed the probing process.

Close-center probing is frequently required on SMT boards, making smaller probes a necessity. Smaller probes are more difficult to use because they are more flexible and tend to add to the probing errors of conventional fixturing. In addition, there are few acceptable methods

for connecting more than one wire to the .050" probe. On boards where probes are densely packed, it is sometimes necessary to counteract probe spring tension mechanically because vacuum fixtures cause warping that can introduce failures. The HP SimPlate Series of test fixtures, with their single-plate design, solve the problems of close-center probing with a 10:1 reduction in probing errors.

Dual-sided probing is needed when circuit density and component placement make single-side access to test nodes impossible. It requires extremely accurate positioning of the two probe plates relative to each other and to the PC board. Longer wires are needed to connect the upper plate to the system interface, affecting signal quality.

To improve signal quality, it is sometimes necessary to use dual-stage probing. This technique easily removes the in-circuit probe loading from the PC board during functional testing on critical nodes. In the past, special probing requirements meant costly, complex fixturing. Hewlett-Packard's automatic fixture generation software and vacuum-actuated and mechanical fixtures provide specialized probing capabilities at affordable prices.

### SMT Testing Solutions

As a major user of SMT, Hewlett-Packard understands the unique demands of testing circuit boards designed with surface mount devices. Each year, Hewlett-Packard designs approximately 150 new products using SMT, requiring placement of over 450 million surface-mount devices yearly on PC boards. The HP 3070 SMT-Series Board Test System combines Hewlett-Packard's expertise in SMT with an extensive background in measurement and computation to provide solutions for SMT test problems.

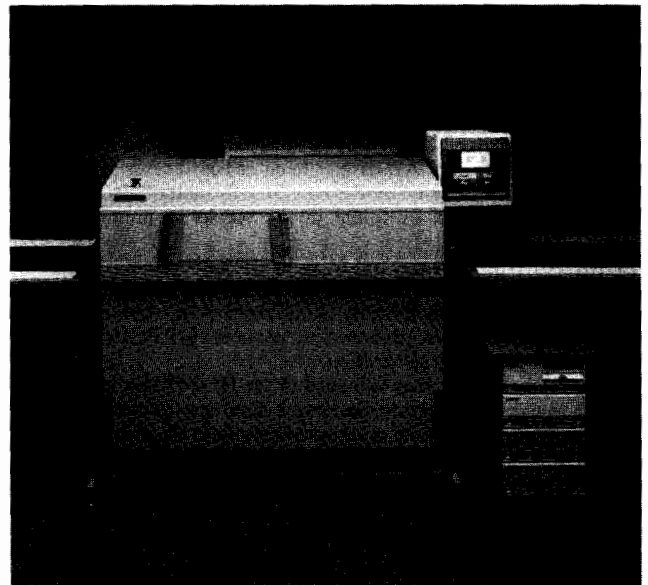

The HP SMT-Series testers provide true combinational test capabilities for testing surface mount devices with an integral mechanical fixturing system to solve the most complex fixturing problems. The HP Integrated Program Generator (HP IPG) automatically develops analog and digital tests, including cluster testing. The HP Express Fixture Software automates the design and construction on the HP SimPlate Express fixtures and HP Express Cassettes for the mechanical fixturing system. The software automatically minimizes top-side probing, fixture wire lengths, and close-center probing.

The HP Express Fixturing System offers unprecedented mechanical accuracy and reliability required for close-center, dual-sided, and dual-stage probing. With its automatic board handling capabilities, the system easily integrates into an automated SMT or other high volume production line.



- In-circuit test systems
- Combinational test systems

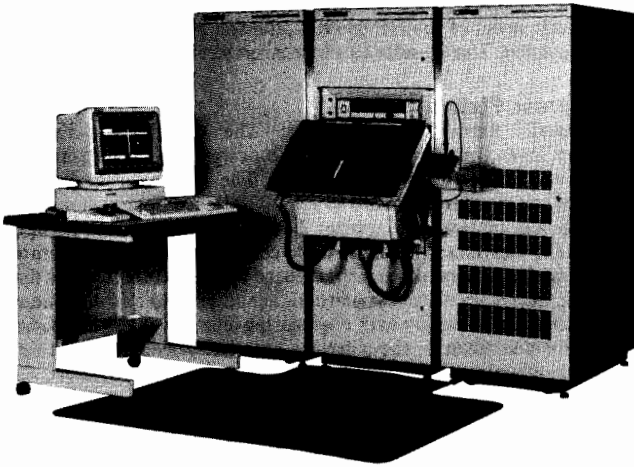

### HP 3065 Board Test Family

Hewlett-Packard offers a complete range of affordable, proven board test products for the electronics manufacturing industry. Building on many years of experience in automatic testing and advanced computer technology, the HP 3065 family provides high-speed digital testing, industry-standard analog in-circuit testing, and analog functional testing. Adding the HP Advanced Technologies hardware and software modules to the L- and X-series testers provides high-speed combinational testing capabilities.

A distributed intelligence architecture and a true multitasking environment allow a single HP 3065CX PLUS controller to support multiple test stations, multiple programming and repair stations, and a variety of peripherals without sacrificing high throughput in production test. The HP 3065 family consists of two controllers (HP 3065CL/CX PLUS), two test stations (HP 3065HL/HX), the HP 3065ST Standard Technologies tester, the HP 3065AT Advanced Technologies combinational tester, and the HP 3065CT Communications Technologies board test system. The wide selection and varied capabilities of the HP 3065 family allow you to configure a test system to meet the challenge of solving your most complex testing problems . . . in the challenging environment of worldwide competition and rapidly changing technologies.

### New Technologies

Remaining competitive and profitable in today's worldwide market-place is a problem faced by all electronics manufacturers. To meet these pressures, manufacturers are turning to new technologies and manufacturing processes that promise shorter product development times and increased product flexibility.

The most rapid technological growth is taking place in the use of advanced device technologies, including SMDs, ASICs, and VLSI, in the manufacture of PC boards. These devices place stringent demands on the test system, usually requiring integrated in-circuit and functional (combinational) test capabilities. Surface mount technology is used to increase device density on PC boards, often placing components on both sides of the boards. In the telecommunications industry, the use of Integrated Services Digital Networks (ISDN) is causing a revolution in the design and testing of new products.

As an innovator in the design and use of these advanced technologies, Hewlett-Packard is a leader in the manufacture of design and test systems such as the HP 3065 family to address these problems.

### Telecommunications Testing

The telecommunications industry is faced with increased worldwide competition, making product cost and test efficiency major issues. Test managers must reexamine their existing test strategies because existing products and the new ISDN technologies will both be produced and must be tested within the same workcell. The HP 3065CT Communications Technologies test system was designed to solve this problem.

The HP 3065CT is a completely integrated, single-stage test system for the telecommunications industry. It is based on the HP 3065AT combinational tester and the telecommunications software. Additional test instrumentation, new software, and integrated library elements allow the HP 3065CT to perform CCITT specification tests on telecom products. Specification testing on the HP 3065CT requires much less time since production-induced faults are detected with its digital, analog, and combinational test capabilities prior to the CCITT tests.

### Digital Testing of Advanced Devices

Advanced technologies, such as surface mount devices (SMDs), application-specific integrated circuits (ASICs), and VLSI circuits, allow the manufacturer to place greater capabilities into smaller geometries. This poses problems, not only in testing the advanced circuitry, but also in accessing the test nodes on the PC board. HP has the test systems, fixturing and applications software to solve these problems.

Fast, repeatable digital testing is required to accurately test these advanced devices. HP's digital test capabilities are on a par with its proven analog testing. Microprocessor bus emulation, clock synchronization, and automatic backtrace capabilities make testing the most complex VLSI circuitry a simple task. ASICs require the ability to access data from CAE/CAD systems for accurate test development. The HP 3065 Pattern Capture Format software provides access to over twenty leading design systems and has an open interface to proprietary in-house systems. In addition, HP's Safeguard In-circuit software analyzes every digital test to minimize the potential for device damage.

### HP Q-STAR Network

The HP Q-STAR Test Network offers the basis for implementing SQC in the manufacturing process while providing the optimum solution for your test workcell needs. It provides the HP 3065 user with the tools to implement quality management techniques, paperless repair management, and test program management at minimal incremental cost.

### Protect Your Investment

The modularity and flexibility of the HP 3065 family of test systems allow the user to keep pace with today's rapidly changing technologies. System compatibility, from the low-cost HP 3065ST to the HP 3065AT combinational tester, ensure that programs and fixtures developed on one system are easily transported to others within the family. Therefore training, test programs, and fixtures are not abandoned when the need for additional capacity arises.

Hewlett-Packard has over 100 board test service offices worldwide, so we are there wherever you are. HP Application Engineering Organization (AEO) and Project Centers can offer complete solutions to your application, hardware, and software support needs anywhere in the world.

### HP 3065 Board Test Family

For more information on the HP 3065 board test family, call your local Hewlett-Packard Sales and Service office. See page 737

HP 3065 Series prices start at

**\$100,500**

# BOARD TEST SYSTEMS

## Test Fixture Products

HP 3065, 3070 Family

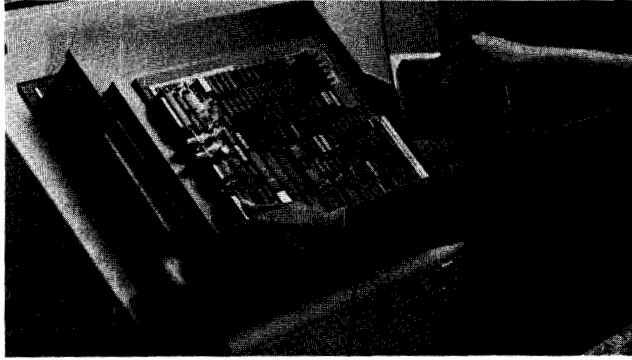

### Test Fixtures

The HP 44203 series of vacuum-actuated test fixtures were introduced in 1986. With only a base plate and a removable support plate, the HP 44203 fixtures offered higher probing accuracy, greater reliability, and easier maintenance than the conventional dual-plate design. The elimination of the top plate and associated hardware reduced the part count of a standard test fixture by 35% and reduced the weight by 23%.

The new HP SimPlate 3070 (HP 44202 series) and HP SimPlate Express (HP 44200 series) test fixtures are based on the HP SimPlate design. Solutions for automation and SMT single- and dual-sided access are provided by the mechanical HP Express Fixturing System (HP 44990A) and its HP Express Cassette fixture.

### HP SimPlate Series

The HP 44203S/D/L fixture kits are designed for the HP 306X board test systems. The single-plate design allows the probes and tooling pins to be mounted on the same plane, resulting in improved probing accuracy and repeatability, making these fixtures an excellent choice for testing both conventional and surface-mount technologies. The removable support plate provides immediate probe access without tools for routine maintenance. Testing can continue during maintenance of PC board gaskets and vacuum seals.

### HP SimPlate 3070 Series

The HP 44202S/L fixtures bring the proven technology of the single-plate design to the HP 3070 family of board testers. Other features include space for custom fixture electronics, friction hinges to hold lid open during maintenance, and easy upgrade from the HP 3065 to the HP 3070 interface.

### HP SimPlate Express Series

The HP 44200S/L fixtures retain the HP SimPlate top plate interface to the PC board under test. The new design supports automatic fixture wiring, lowering the cost while improving the quality of the fixture. Locating grids allow for easy fixture assembly and debug. Average wire lengths of 75 mm (3") and wire lengths of 25 mm (1") for critical nodes provide the high signal quality necessary to test today's advanced high-speed devices.

### HP Express Fixturing System

The HP 44990A Express Fixturing System provides the exceptional mechanical fixturing accuracy needed for close-center, dual-sided probing for SMT boards. Board flatness is controlled by push rods that oppose areas of high probe density, ensuring accurate probe positioning and contact. Programmable dual-stage probing heights make it easy to remove in-circuit probe loading from the PC board during functional testing of critical circuits.

The system is designed for flexible operation to meet the varying demands of production testing. It can be operated manually in a pass-back mode, partially automated, or fully automated in an in-line mode. The HP Express Fixturing System's light curtains and safety sensors protect the operator from injury and the PC board from accidental damage. Electrostatic charge buildup is reduced because mechanical fixturing eliminates air flow across the board, and automatic loading and unloading minimizes board handling by the operators. The HP 44990A is included with the HP 3070 SMT-Series board test systems.

### HP Express Cassettes

Express Cassettes are built from the HP 44200S SimPlate Express vacuum fixture kit plus either the HP 44201SC or HP 44201SEC Cassette conversion kits. The Express Cassette is a rugged, mechanically operated fixture that is ideal for high-volume testing applications. Its one-piece design makes it easy to handle and store. When the cassette is out of the HP 44990A, the test probes and wiring are fully protected. The cassette can be converted to a vacuum-actuated fixture.

### HP Express Fixture Software

Automatic fixture generation with the HP Express Fixture Software saves time and money in the design and construction of single- and dual-sided test fixtures. The HP Express Fixture Software is a standard part of the HP 3070 Board Test System. The software automatically minimizes fixture wire lengths; selects optimum probe locations; minimizes close-center probe usage; generates to-from wiring guides; positions the board on the fixture; creates files for use in automatic fixture construction; and designs and documents fixture changes to comply with engineering changes to the PC board. For dual-sided fixtures, the software automatically minimizes top-side probing and assigns transfer pins.

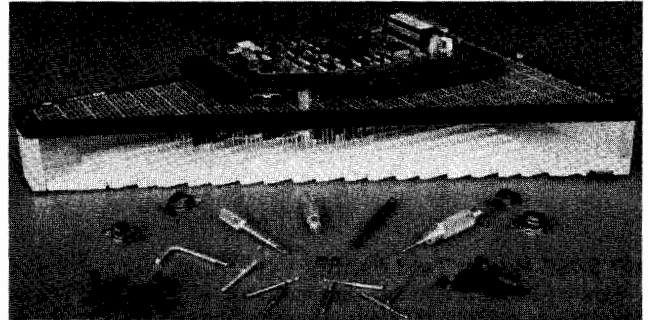

### Accessories

A full line of accessories for fixtures is available from Hewlett-Packard.

### Ordering Information

	Price
HP 44200S Standard HP SimPlate Express Fixture Kit	\$690
HP 44200L Large HP SimPlate Express Fixture Kit	\$1,050
HP 44201SC Bottom-Sided Probing Cassette Conversion Kit	\$750
HP 44201SEC Two-Sided Probing Cassette Conversion Kit	\$1495
HP 44201T Transfer Pin Kit, 20 pins per bag	\$105
HP 44202S Standard HP SimPlate 3070 Fixture Kit	\$710
HP 44202L Large HP SimPlate 3070 Fixture Kit	\$1,090
HP 44202P Interface Pin Blocks	\$55
HP 44203S HP SimPlate Standard Fixture Kit	\$670
HP 44203D HP SimPlate Dual-well Fixture Kit	\$990
HP 44203L HP SimPlate Large Fixture Kit	\$890
HP 44265B Dual-stage Single Point Probes, 10 per bag	\$37
HP 44266B Dual-stage Star Point Probes, 10 per bag	\$37
HP 44274B Dual-stage Receptacles, 10 per bag	\$22
HP 44274S HP SimPlate Receptacles, 100 per bag	\$38
HP 44275P Personality Pins, 100 per bag	\$45
HP 44561L/H Low or High Force Single Point Probe, 100 per bag	\$105
HP 44562L/H LF or HF Serrated Point Probe, 100 per bag	\$105
HP 44563L/H LF or HF Star Point Probe, 100 per bag	\$105
HP 44564L/H LF or HF Spear Point Probe, 100 per bag	\$166
HP 44265F Spear Point Probes-50 mil, 50 per bag	\$110
HP 44265C Chisel Point Probes-50 mil, 50 per bag	\$110
HP 44266F Star Point Probes-50 mil, 50 per bag	\$110
HP 44274F Receptacle-50 mil, 50 per bag	\$59
HP 44990A HP Express Fixturing System	\$64,550

### PCM Conversion Measurements

Today's circuit-switched integrated digital networks (IDN) are almost all based on 64 kb/s PCM voice channels using either CEPT A-law or Bell  $\mu$ -law coding formats.

The HP 3776A/B terminal test set, for use mainly in installation and commissioning, can make both PCM voice and analog data measurements in both analog and digital domains. The HP 3779 C/D primary multiplex analyzer is optimized for R & D, production test and commissioning of line cards and PCM multiplexers/channel banks.

### Digital Transmission (TDM)

The emphasis in measuring the performance of digital transmission systems has shifted to monitoring the end-to-end performance in terms of %error-free seconds and availability. This gives a clearer and more thorough analysis of how faults affect the networks. Most of the digital transmission analyzers from Hewlett-Packard now incorporate analysis to G.821 or the appropriate North American standards for error performance.

### CEPT Hierarchy

The CEPT digital hierarchy has four currently defined levels for network interconnection and test: 2, 8, 34 and 140 Mb/s.

The HP 3764A digital transmission analyzer is available in a number of variants to cater for different testing needs: a 2, 8, 34, and 140 Mb/s BER version for general network test and a 140 Mb/s BER and jitter version for troubleshooting and manufacturing applications. Versions with an internal synthesizer provide variable frequency operation to 170 Mb/s and more flexible offset testing.

For field-test applications at 0.7, 2, 8, 34 and 140 Mb/s, the new HP 37721A digital transmission analyzer combines all the necessary measurements in a compact, portable and rugged case with built-in printer.

For testing on lower-capacity systems, the HP 3780A pattern generator/error detector provides flexible operation at rates up to 50 Mb/s in a single package.

Fast, easy measurements of error and jitter performance to 50 Mb/s are possible with the HP 3784A digital transmission analyzer. It has standard CCITT interfaces at 704 kb/s and 2, 8 and 34 Mb/s and optional data circuit testing capability at 64 kb/s. The HP 3788A error performance analyzer is a BERTS for use in the installation and maintenance of digital data circuits, lines and multiplexers. It has CEPT interfaces at 2 Mb/s and 64 kb/s and also caters for 704 kb/s operation. Lightweight and rugged, this battery-powered instrument is ideal for operation in harsh environmental conditions.

### North American Hierarchy

Of the four main levels currently defined, the most important are DS1 (1.544 Mb/s) -

used primarily for local distribution - and DS3 (44.736 Mb/s) which is the high-capacity building block for the long-haul toll circuits.

The HP 3789B DS3 transmission test set not only measures BER and jitter on a DS3 signal, but also extracts and measures BER and jitter on each of the component DS1 digroups, making it an ideal troubleshooting aid. Optionally, the HP 3789B can provide both measurement and stress-test capability on C-bit parity framed signals at DS3.

### Digital Leased Service Measurements

In North America, digital leased services include T1 (1.544 Mb/s) and digital data system (2.4/4.8/9.6/56 kb/s). The HP 3787B digital data test set measures both error and jitter performance on these T1 and DDS services. It has substrate drop and insert capability and can perform measurements on customer substrate primary and secondary channels. The HP 3787B is particularly suited to the manufacturing test of T1, DDS and DCS equipment, as well as network installation and maintenance.

For T1 circuit installation and maintenance, the HP 37701A T1 tester provides a rugged, portable and compact solution. It performs a wide range of error and signal measurements in the central office, on users' premises and at intermediate points.

### Jitter and Digital Networks

Jitter test sets incorporating both jitter generation and measurement capability help manufacturers design equipment to meet the recommended jitter performance specified in the standards documents. In operational digital networks, jitter accumulation varies with the traffic pattern content. Incorporating jitter measurements into BER test sets such as the HP 3764A, HP 3784A, HP 3787B and HP 3789B couples the analysis of timing jitter with error analysis to pinpoint fault mechanisms efficiently.

### Lightwave Transmission Systems

Lightwave transmission predominates for bit rates above 140 Mb/s and DS3. For electrical tests on these high-speed systems, the new HP 71601A and HP 71603A error performance analyzers cover bit rates up to 1 Gb/s and 3 Gb/s respectively. They are built in Hewlett-Packard's modular measurement system, allowing the user to define cost-effective configurations for manufacturing and R&D.

Also, special options are available on the HP 3764A and HP 3784A digital transmission analyzers for jitter and BER measurements at the SONET rates STS1 and STS3.

Instruments	North American Interfaces				CEPT Interfaces				SONET		General Purpose			Measurements			Data Logging		Remote Control								
	Datacom Interfaces	DS0/DDS	DS1 (1.544 Mb/s)	DS1C (3.152 Mb/s)	DS2 (6.312 Mb/s)	DS3 (44.736 Mb/s)	64 kb/s Codirectional	704 kb/s	2 Mb/s	8 Mb/s	34 Mb/s	140 Mb/s	STS1 (51.84 Mb/s)	STS3 (155.52 Mb/s)	≤50 Mb/s	≤170 Mb/s	≤1 Gb/s	≤3 Gb/s	In-service Errors	Out-of-service Errors	Jitter	VF/PCM	Data Impairments	Internal Results Storage	Built-in Printer	HP-IB	RS-232-C
HP 3764A Opt 001									•	•	•								•							•	•
HP 3764A Opt 002																			•	•						•	•
HP 3764A Opt 006								•	•	•	•								•							•	•
HP 3764A Opt 007												•							•	•						•	•
HP 3776A																						•	•				•
HP 3776B		•																				•	•				•
HP 3779C																						•	•				•
HP 3779D		•																				•	•				•
HP 3780A			▲	▲	▲	▲			▲	▲	▲																
HP 3784A								•	•	•	•											•	•				•
HP 3784A Opt 002								•	•	•	•											•	•				•
HP 3784A Opt 006	1							•	•	•	•		3									•	•				•
HP 3784A Opt H13																						•	•				•
HP 3787B		•	•	•																		•	•	+			•
HP 3789A								•	•	•												•	•				■
HP 3789B			*			•																•	•				•
HP 37701A/37711A	2		•																			•	•				•
HP 37721A								•	•	•	•											•	•				•
HP 71601A																											•
HP 71603A																											•

▲ - See options 101, 102 and 103.  
 \* - DS1 access/measurement via built-in demultiplexer.  
 ■ - For printer interface only.  
 + - VF output.

1 - V.11/X.21 interface up to 2 Mb/s.  
 2 - Datacom to 1.5 Mb/s in HP 37711A, see page 32.12.  
 3 - Special options.

# TELECOMMUNICATIONS TEST EQUIPMENT

## Digital Transmission Analyzer and Error Performance Analyzer

HP 3784A, 3788A

### HP 3784A

- G.821 error analysis at 704 kbit/s, 2, 8 & 34 Mbit/s
- Optional jitter generation & measurement at 2, 8 & 34 Mbit/s
- Clock synthesizer for rates between 1 kbit/s & 50 Mbit/s
- Optional V.11 interfaces for testing X.21 leased circuits

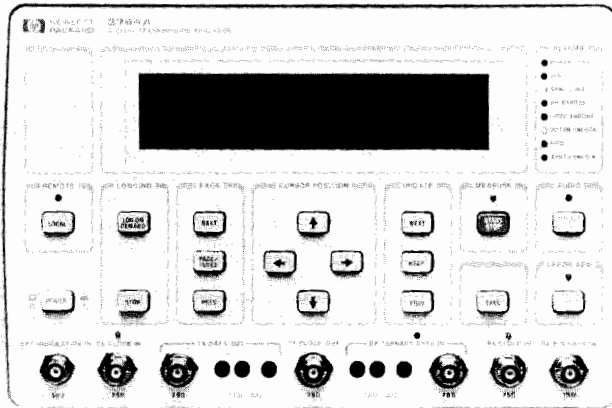

HP 3784A



### HP 3784A Digital Transmission Analyzer

The HP 3784A is a portable error performance/jitter test set, offering standard telecom interfaces at 704 kbit/s, 2, 8 and 34 Mbit/s, with the option of codirectional interfaces at 64 kbit/s and V.11 interfaces for testing X.21 leased circuits. In addition, it has binary TTL/ECL interfaces for measurements up to 50 Mbit/s, using the internal clock synthesizer.

The HP 3784A is easy to use with measurement presets, automatic receiver setup and error performance pass/fail thresholds. Automatic jitter tolerance and transfer plotting routines are provided for fast accurate testing up to and beyond CCITT limits. Through-data mode allows jitter to be added to a structured signal for jitter tolerance testing of demultiplexers.

#### Applications

- Automated production test of transmission line and terminal equipment
- Development and test of digital circuits that transport or store data
- Long-term monitoring of digital transmission equipment in the field

#### Measurement Summary

**Error Analysis:** Error count, error ratio, error and error-free intervals (seconds and deciseconds), % unavailability, % errored and % severely-errored seconds, % degraded minutes. All measurements are made simultaneously.

**Jitter Analysis:** Peak-to-peak amplitude, jitter hit count, jitter hit and hit-free seconds or deciseconds.

#### Ordering Information

	Price
HP 3784A digital transmission analyzer	\$10,300
Opt 002: jitter measurements	\$5,860
Opt 006: 64 kbit/s measurements & V.11 interfaces	\$1,110

Note: Options 002 and 006 cannot be ordered together

### HP 3788A

- Low-cost, lightweight, and robust for field use
- Error measurement at 2048, 704 & 64 kbit/s CEPT rates
- Basic measurements & G.821 error analysis
- Long-term internal logging of results
- Internal, rechargeable battery or ac operating

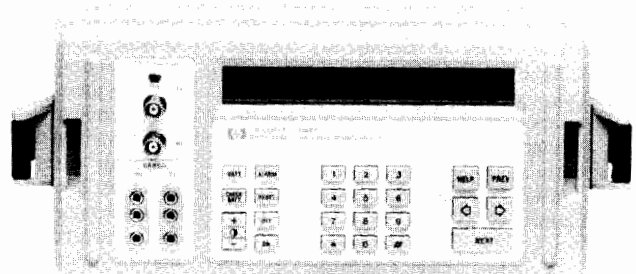

HP 3788A

### HP 3788A Error Performance Analyzer

The HP 3788A is a low-cost, portable, bit-error-ratio test set. Unframed test patterns are used to measure errors at 2048, 704 and 64 kbit/s CEPT standard rates. Measurements include error count and error ratio for fast circuit testing, and powerful error performance analysis for long-term monitoring. Analysis results are stored internally and either logged to an RS-232-C printer or viewed on the display. The HP 3788A operates from an internal battery, with typical operation time of 10 hours, or a charger/ac adapter.

The HP 3788A is intended for use by PTTs, telecom service providers and private network operators.

#### Applications

- Error performance analysis during installation and out-of-service maintenance of digital data circuits, lines, and multiplexers at 2048, 704 and 64 kbit/s (codirectional interface)
- In-service error performance monitoring at 2048 and 704 kbit/s using line code errors

#### Measurement Summary

**Error Analysis:** Error count (EC), error ratio (ER).

**G.821 Analysis:** Maximum and average error ratio, error seconds (ES, % ES), severely-errored seconds (SES, % SES), degraded minutes (DM, % DM), unavailable seconds (US, % US), alarm seconds (ALMS, % ALMS). All measurements are made simultaneously.

**User-defined G.821 Analysis:** As above, but with selectable analysis interval and error thresholds.

**Threshold Analysis:** Provides selectable analysis interval, error count, and error ratio logging thresholds. Results: EC, Max ER, AvER, EI, % EI, SEI, % SEI.

#### Ordering Information

HP 3788A Error Performance Analyzer

Price

\$3,000

# TELECOMMUNICATIONS TEST EQUIPMENT

## Digital Transmission Analyzers

HP 3764A, 37721A

549

### HP 3764A

- Error & jitter measurements at 140 Mbit/s or error measurements at 704 kbit/s, 2, 8, 34 & 140 Mbit/s
- Internal synthesizer for measurements from 1 kbit/s to 170 Mbit/s at binary interfaces
- Powerful data logging to internal or external printer
- Fast, easy measurement setup using stored presets

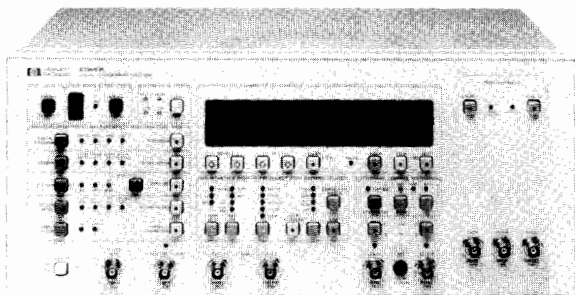

HP 3764A  
Option 007



### HP 3764A Digital Transmission Analyzer

The HP 3764A digital transmission analyzer is available in a number of different versions to cover a wide range of telecom and general-purpose test applications. Each one offers pattern generation and error detection at coded and binary interfaces, and an HP-IB port for remote control operation.

A version of the HP 3764A with combined error and jitter performance measurements at 140 Mbit/s is ideal for production test of telecom equipment. It can be further enhanced with a through-data mode to allow jitter to be added to any 140 Mbit/s signal passing through the instrument.

Versions of the instrument with CEPT rates from 704 kbit/s to 140 Mbit/s offer a test solution for manufacturing and installation of digital network equipment. Other versions, including a clock synthesizer, offer data generation and error detection at binary interfaces at rates up to 170 Mbit/s.

#### Applications

- Production testing of digital transmission equipment
- Installation and maintenance of digital networks
- Demultiplexer testing using through-data mode to add jitter to a structured signal
- Long-term unattended monitoring with error performance analysis based on CCITT Recommendation G.821

#### Measurement Summary

**Error analysis:** Error count, error ratio, error seconds, error-free seconds, % unavailability, % errored seconds, % severely-errored seconds, % degraded minutes. All measurements are made simultaneously and in accordance with CCITT Recommendation G.821.

**Jitter analysis:** Peak-to-peak amplitude, jitter hit count, jitter hit seconds, jitter hit-free seconds. Internal filters to CCITT Recommendation O.171 are available for performing selective jitter measurements. Where a greater degree of selectivity is required, a demodulated jitter output allows connection of external equipment such as a spectrum analyzer.

#### Ordering Information

	<b>Price</b>
HP 3764A digital transmission analyzer	\$11,610
Opt 002 Jitter generation and measurement at 140 Mbit/s	+\$3,115
Opt 007 Jitter generation and measurement at 140 Mbit/s with through-data mode plus clock synthesizer	+\$7,070
Opt 006 Error performance at 704 kbit/s, 2, 8, 34 & 140 Mbit/s plus clock synthesizer	+\$2,730

### HP 37721A

- Bit & code error testing at 704 kbit/s, 2, 8, 34 & 140 Mbit/s
- Portable, lightweight & rugged
- Text & graphic results on large display
- Stored setups & autoselection for ease of use
- Remote control, frequency offset & measurement, multiple outputs

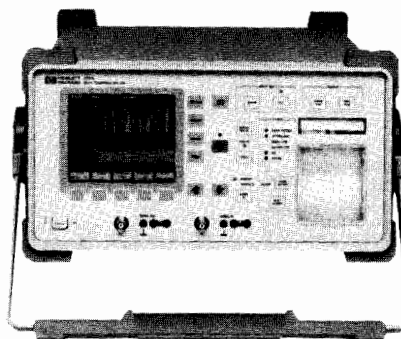

HP 37721A



### HP 37721A Digital Transmission Analyzer

The HP 37721A digital transmission analyzer is a portable, lightweight, rugged test set providing bit and code error testing at the European CEPT rates of 704 kbit/s, 2, 8, 34 and 140 Mbit/s. It measures error performance to CCITT Recommendation G.821, with interfaces to G.703.

A key feature of the HP 37721A is its ease of use: the autoselection facility automatically configures the test set to the incoming data; nine stored setups ensure that required test parameters are instantly available; graphic display of results shows error counts, error seconds and alarms at a glance; and a range of logging options to an internal or external printer provides customized hard-copy proof of results.

Option 001 provides remote control via RS-232-C and HP-IB interfaces and adds the ability to log results to an HP ThinkJet. Multiple outputs in Option 002 enable simultaneous loading of four channels of a multiplexer or digital radio with only one test set. With Option 003, up to 100 ppm of frequency offset is provided at all rates to evaluate clock-recovery circuits.

#### Applications

- Maintenance of digital networks (PTTs, other network operators)
- Installation of digital networks (PTTs, network operators, manufacturers)
- Long-term unattended monitoring with error performance analysis based on CCITT Recommendation G.821

#### Measurement Summary

**Error analysis:** As CCITT Recommendation G.821.

**Results displayed:** Elapsed time in test period; errored seconds, % errored seconds, error-free seconds, % error-free seconds, severely-errored seconds, % severely-errored seconds; unavailability, % unavailability; degraded minutes, % degraded minutes; code-error seconds; bit error count, bit error ratio; code error count, code error ratio; frequency, frequency offset; and alarms.

#### Ordering Information

	<b>Price</b>
HP 37721A digital transmission analyzer	\$7,670
Opt 001 Remote control	+\$645
Opt 002 Multiple outputs	+\$1,720
Opt 003 Frequency offset	+\$1,075

# TELECOMMUNICATIONS TEST EQUIPMENT

## T1 and Digital Data Test Sets

HP 3787B, 37701A

- Carry out stress & compliance tests on DDS/Dataport & T1/T1C equipment
- In manufacturing, replace whole racks of test equipment with one set
- Reduce network downtime with error monitoring, analysis & logging

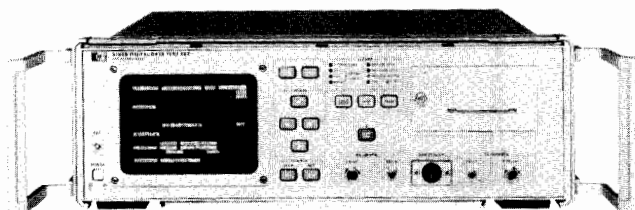

HP 3787B



### HP 3787B Digital Data Test Set

The HP 3787B combines T1/T1C and DDS testing in one, portable test set. A built-in multiplexer/demultiplexer allows test patterns, control codes or external data to be inserted into, or extracted from, individual timeslots, subrates, and overhead channels. Measurements range from simple BER tests to full error analysis, as well as signal level and optional DS1 jitter measurement.

#### Applications

- DDS/Dataport and T1 equipment manufacturing
- Network installation and maintenance
- Performance monitoring

#### Specifications

Full transmit and receive capability.

**Interfaces:** DS0 A/B, DS1 (D4, ESF, T1DM, SLC-96), DS1C.

**Test patterns:** 2<sup>23</sup>, 2<sup>20</sup>, 2<sup>15</sup> PRBS; QRSS, 3 in 24, 8-bit word, loop & control codes; TA55 DDS stress patterns, 256-byte user pattern (DS0 only).

External clock input for jitter generation.

Error detection, analysis and logging on all test patterns.

Frame slips measurement.

Built-in printer.

HP-IB and RS-232 remote control interfaces.

**Size:** 130 H x 425 W x 420 mm D (5.12" x 16.73" x 16.54").

**Weight:** 10.4 kg (23 lb).

#### Ordering Information

HP 3787B Digital data test set	\$9,590
Opt 001 DS1 jitter measurement	+\$935
Opt 002 DC operation (48V)	+\$620
Opt 003 Channel VF output	+\$390

Special options are available to give 32 or 64 additional DSX-1 outputs and DS0 operation with a composite clock signal.

#### Accessories

HP 15513A 1m WECO 310 - WECO 310 cable	\$62
HP 15668A Front-panel DDS clock cable	\$128
HP 15669A Rear-panel DDS clock cable	\$128

- Complete range of T1 installation & maintenance measurements in one tester
- Low-cost, rugged, easy-to-use
- Adaptable to future requirements - no need to re-equip
- Powerful results storage & analysis without using a printer

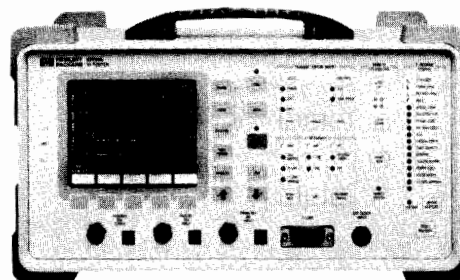

HP 37701A



### HP 37701A T1 Tester

The HP 37701A performs bit-error and signal measurements on T1 circuits in central offices, at outside locations, and on the users' premises. Built-in CSU emulation allows circuits to be proven before user equipment is connected. Autoconfigure, "trouble scan", and pre-stored setups, together with clear simple controls, make the tester easy to use. The HP 37701A T1 tester is easily upgraded to the HP 37711A T1/datacom test set (see page 573).

#### Applications

- Leased T1 circuit installation and maintenance
- T1 circuit monitoring in central offices
- Acceptance testing and maintenance by T1 users

#### Specifications

Full transmit and receive capability.

**Receiver range:** 6 to -36 dB DSX with equalization.

**Framing:** D4, ESF, SLC-96.

**Line codes:** AMI, B8ZS.

**Test patterns:** 2<sup>23</sup>, 2<sup>20</sup>, 2<sup>15</sup> PRBS; QRSS, 3 in 24, 1:1, 1:7, 55 octet, 24-bit word.

**Measurements:** Error performance based on BPVs, logic, frame & pattern errors; frequency, pattern slips, simplex current, level, round trip delay, pulse shape.

Channel VF output including internal loudspeaker.

RS-232 remote control and printer interface.

Universal ac power supply.

**Size:** 190 H x 340 W x 208 mm D (7.5" x 13.4" x 8.2").

**Weight:** 4.5 kg (10 lb).

#### Ordering Information

HP 37701A T1 tester	\$4,700
Opt 001 Pulse shape and wander/clock slips measurement	+\$550
Opt 002 Built-in rechargeable battery and charger	+\$750
Opt 003 Graphic results presentation, result storage and G.821 performance analysis	+\$700

#### Accessories

HP 15513A 1m WECO 310 - WECO 310 cable	\$62
HP 18182A 1.5m WECO 310 - crocodile clip cable	\$67
HP 15710A Soft-fabric carrying case	\$170

# TELECOMMUNICATIONS TEST EQUIPMENT

## DS3 Transmission Test Set and Digital Transmission Analyzer

HP 3789B, 3784A

551

### HP 3789B

- Error & jitter measurement at DS3 & DS1
- Built-in DS3 to DS1 multiplexer

- C-bit parity generation & measurement
- DS3 idle signal generation & detection
- Optional built-in data logging

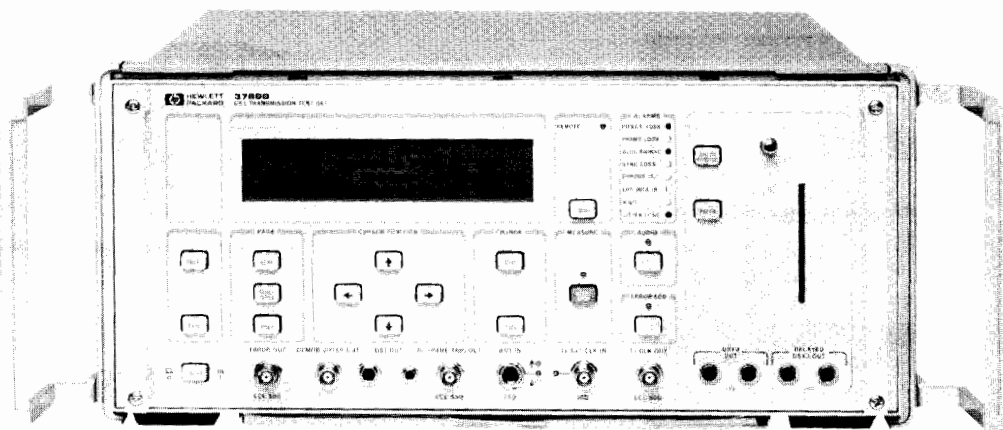

HP 3789B



### HP 3789B DS3 Transmission Test Set

The HP 3789B is a powerful test set offering outstanding monitoring and troubleshooting capability for DS3 digital transmission equipment. A built-in demultiplexer allows it to perform measurements on both DS3 and DS1 signals from a DS3 access point. On equipment using the new C-bit parity framing format, the HP 3789B can measure the end-to-end performance of a transmission path in both directions simultaneously from a single access point.

Jitter measurements at DS3 and DS1 are available to help diagnose timing problems quickly and easily. HP-IB and RS-232-C ports are provided for remote control operation or for logging results to an external printer. Optional enhancements include dc operation, and a built-in printer or 3.5-inch disk drive.

#### Applications

- System turn up checks
- Routine testing of trunks
- Fault sectionalization
- Identifying fault mechanisms
- Preventive maintenance
- Service quality verification
- Outage detection & isolation
- Trouble referral verification
- Equipment & route assessment
- Longterm performance monitoring

#### Measurement Summary

**DS3 errors:** Bit (logic), frame, parity and code (BPV) in the form of error count, error ratio, error seconds, error-free seconds.

**Error bursts:** The number of bursts with > 100 errors is counted.

**Error distribution:** Error seconds, containing 1 error, 2 to 10 errors and > 10 errors, are counted separately.

**DS3 analysis:** % availability, % unavailability, % error seconds, % degraded minutes, consecutive severely-errored seconds (CSES). These can be configured for numeric results or pass/fail results against selectable thresholds.

**DS3 jitter:** Maximum peak amplitude, jitter hit count, hit bit count, hit bit ratio, hit second count, hit-free second count.

**DS1 errors:** Bit (logic), frame, CRC (extended superframe format).

**DS1 jitter:** Maximum peak-peak, maximum positive peak, maximum negative peak, jitter hit count.

**C-bit parity errors:** Cp parity errors expressed as error count, error ratio, error seconds, error-free seconds, error seconds types A, B & C.

**C-bit alarms:** The far-end alarm and control channel (FEAC) is monitored and decoded. The current alarm status is displayed textually and in bit format.

**FEBC bits:** The far-end block error bits are monitored and their information is displayed as error ratio, error seconds, error seconds types A, B & C.

### HP 3784A Digital Transmission Analyzer

#### Special Options

Special versions of the HP 3784A digital transmission analyzer offer error and jitter measurements at North American and binary interfaces, using unframed data. They provide all the features of the standard instrument (see page 548) with North American data rates, DS1 (1.544 Mbit/s), DS1C (3.152 Mbit/s), DS2 (6.312 Mbit/s) and DS3 (44.736 Mbit/s), replacing the European data rates. Another version offers STS1 (51.84 Mbit/s) for testing SONET equipment.

Automatic and manual jitter measurements offer a fast, accurate means of characterizing digital transmission equipment. In addition, jitter can be added to any standard data signal passing through the instrument to allow testing of demultiplexers with a framed signal.

#### Measurement Summary

**Error analysis:** Error count, error ratio, error and error-free intervals (seconds or deciseconds), % unavailability, % errored and % severely-errored seconds, % degraded minutes. All measurements are made simultaneously.

**Jitter analysis:** Peak-to-peak amplitude, jitter hit count, jitter hit and hit-free seconds or deciseconds.

#### Ordering Information

**HP 3789B DS3 transmission test set** **Price**  
\$12,170

The standard package consists of receiver; generator with 6 outputs; built-in demultiplexer to DS1, both HP-IB and RS-232-C ports, real-time clock, WECO 560A type connectors fitted to Rx and Tx (alternative connector types are available). For additional capability, select from the following options.

- Opt 002** Second measurement capability (including C-bit parity generation/ measurement and jitter measurements at DS1) +\$555
  - Opt 003** Second measurement capability (including C-bit parity generation/measurement and jitter measurements at both DS1 and DS3) +\$1,505
  - Opt 004** Delete option - removes DS1 output capability -\$350
  - Opt 005** Built-in operation from 24V/48V dc supplies +\$885
  - Opt 010** Built-in 24-column printer +\$570
  - Opt 011** Built-in 3.5-inch disk drive +\$730
- Note Options 010 and 011 cannot be ordered together

**HP 3784A digital transmission analyzer** \$10,300

- Opt 002/H09:** For error and jitter measurement capability at DS1, DS1C, DS3 and STS1 +\$7,460
- Opt H12:** For error measurement capability at DS1, DS1C, DS2 and DS3 +\$600
- Opt 002/H13:** For error and jitter measurement capability at DS1, DS1C, DS2 and DS3 +\$7,110

# TELECOMMUNICATIONS TEST EQUIPMENT

## Gigabit Error Performance Analyzers and Pattern Generators

### HP 71600 Series

- Variable data/clock delay
- Automatic setting of data threshold & decision point
- Sync-loss detection with fast automatic resync
- User formattable results
- Screen-based pattern editor
- Trigger anywhere in pattern
- True complementary outputs
- Low phase noise clock source

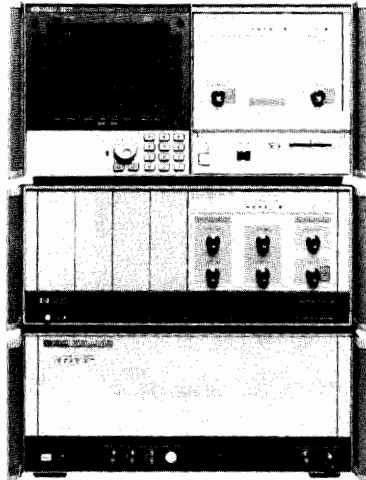

HP 71603A

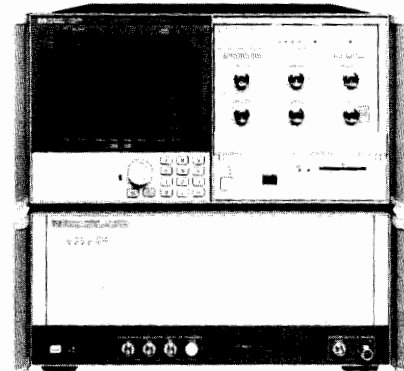

HP 71604A



### HP 71600 Series Error Performance Analyzers

The HP 71601A and HP 71603A error performance analyzers consist of pattern generator, error detector and synthesized clock source configured in the HP 70000 modular measurement system (MMS). The HP 71601A covers the range 50 Mbit/s to 1 Gbit/s and the HP 71603A from 100 Mbit/s to 3 Gbit/s. The HP 71600 series incorporates electronic phase shifters for rapid adjustment of data/clock delay. Measurement speed is increased further with fast pattern synchronization and automatic setting of data threshold and decision point in the receiver. Error distribution is analyzed by counting errored and error-free intervals between 1 second and 1 millisecond. Adjustments can be tracked with continuously updated delta error count and delta error ratio measurements.

#### Applications

- Lightwave systems
- Satellite systems
- High-speed local-area networks (LANs)

#### Specifications

**Bit rate:** 50 Mbit/s to 1 Gbit/s (HP 71601A),  
100 Mbit/s to 3 Gbit/s (HP 71603A),  
(settable to 1 Hz).

**Patterns:** as for pattern generators.

**Data outputs:** as for pattern generators.

**Data input:** 0.5V to 2V p-p amplitude.

**Termination voltage:** selectable 0V or -2V nominal.

**Delay:** data/clock delay  $\pm$  1 ns, resolution 5 ps.

#### Ordering Information

	Price
HP 71601A 50 Mbit/s to 1 Gbit/s Error Performance Analyzer	\$64,300
HP 71603A 100 Mbit/s to 3 Gbit/s Error Performance Analyzer	\$95,000

Individual modules can be ordered for configuring custom-designed systems:

HP 70846A 50 Mbit/s to 1 Gbit/s Error Detector Module	\$16,000
HP 70842A 100 Mbit/s to 3 Gbit/s Error Detector Module	\$25,800
HP 15680A RF Accessory Kit	\$1,400

### HP 71600 Series Pattern Generators

The HP 71602A and HP 71604A pattern generators consist of pattern generator and synthesized clock source configured in the HP 70000 modular measurement system (MMS). The HP 71602A covers the range 50 Mbit/s to 1 Gbit/s and the HP 71604A from 100 Mbit/s to 3 Gbit/s. The HP 71600 series incorporates a screen-based editor for user-defined bit patterns and complementary outputs that simplify testing of high-speed devices and assemblies. Fast, reliable operation of the electronic phase shifter for data/clock delay, ensures rapid analysis of eye-openings and decision windows.

#### Applications

- Gallium-Arsenide and high-speed silicon IC test
- Optical component test
- High-speed computer hardware development

#### Specifications

**Bit rate:** 50 Mbit/s to 1 Gbit/s (HP 71602A),  
100 Mbit/s to 3 Gbit/s (HP 71604A),  
(settable to 1 Hz).

**Rise time (20% to 80%):** < 90 ps (HP 71604A),  
< 180 ps (HP 71602A).

**Patterns:**  $2^{23}-1$ ,  $2^{15}-1$ ,  $2^{10}-1$ ,  $2^7-1$ ; zero substitution/variable mark density patterns; variable length user patterns from 1 to 8192 bits (from 1 to 255 bits in 1-bit steps; 256 to 8192 bits in 32-bit steps).

**Data & Data outputs:** ECL or variable 0.25V to 2V p-p amplitude into 50 ohm.

**Delay:** data/clock delay  $\pm$  1 ns, resolution 5 ps.

#### Ordering Information

	Price
HP 71602A 50 Mbit/s to 1 Gbit/s Pattern Generator	\$41,600
HP 71604A 100 Mbit/s to 3 Gbit/s Pattern Generator	\$62,500

Individual modules can be ordered for configuring custom-designed systems:

HP 70845A 50 Mbit/s to 1 Gbit/s Pattern Generator Module	\$19,500
HP 70320A Signal Generator Module (for 1 Gbit/s operation)	\$17,000
HP 70841A 100 Mbit/s to 3 Gbit/s Pattern Generator Module	\$27,500
HP 70322A Signal Generator Module (for 3 Gbit/s operation)	\$35,000



# TELECOMMUNICATIONS TEST EQUIPMENT

## PCM Terminal Test Set, Primary Multiplex Analyzer, Channel Selector

HP 3776A, 3776B, 3779C, 3779D, 3777A

553

### HP 3776A/B

- Voice, PCM and data (option 001) measurements in one portable instrument
- Network test of 4 kHz channels at VF and 2/1.5 Mbit/s PCM interfaces
- A-A, A-D & D-A measurements (for full & half-channel tests)
- Direct output to printer or plotter
- Set and monitor framing and signaling bits

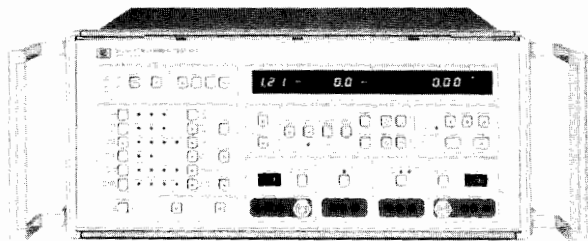

HP 3776A

### HP 3779C/D

- Manufacturing/R&D test of digital line cards/channel banks
- A-A, A-D & D-A measurements (for full & half-channel tests)
- Comprehensive PCM in-band and out-of-band measurements (to 40 kHz)
- Limit checking, sequencing, and direct control of printer and channel selector for ease of system integration
- Complex impedance terminations

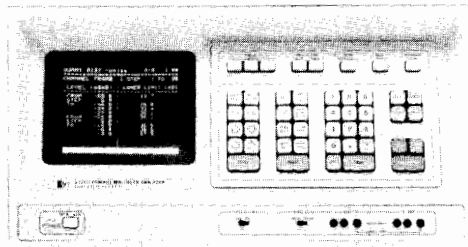

HP 3779C



### HP 3776A/B PCM Terminal Test Set

The HP 3776A is designed for CEPT/CCITT compatible networks. Model 3776B is designed for Bell/Japanese/CCITT compatible networks. Full specifications are contained in the specification booklet.

#### HP 3776A

The HP 3776A has 30/31 channel voice test capability. The VF and PCM interfaces allow multiplexers to be tested to CCITT Recommendations G.712 to G.714. Option 001 provides datacom measurements conforming to the relevant CCITT "O" Series Recommendations.

#### HP 3776B

The HP 3776B has selectable Bell standard or Bell extended superframe (ESF) capability. Line coding is either AMI or B8ZS (clear channel). HP 3776B Option 002 has modified measurements and I-214 connectors for Japan. The VF and PCM interfaces allow channel banks to be tested to BSTR PUB 43801 specifications. Option 001 provides datacom measurements conforming to IEEE STD 743-1984.

### HP 3777A Channel Selector

- DC to 110 kHz
- 2-wire/4-wire balanced switching
- Remote control only (HP-IB)

The HP 3777A is a 4-pole access switch for telecom applications. It may be configured as a single 4-wire switch or as two, independent, 2-wire switches. Channel capacity is arranged by adding standard modules. Unselected channels are switched to 600 ohm terminations. Special options are available with other termination values including none (open circuit).

#### HP 3777A Options

No. of Channels	Connectors	
	Siemens 3-Pln	WECO 310
6	Opt H07	Opt H16
12	Opt 002	Opt 003
18	Opt H13	Opt H17
24	Opt H14	Opt 001
30	Std	Opt H05

#### Ordering Information

HP 3776A PCM Terminal Test Set (CEPT)	\$13,680
HP 3776B PCM Terminal Test Set (Bell)	\$14,900
HP 3777A Channel Selector	\$5,700

### HP 3779C/D Primary Multiplex Analyzer

The HP 3779C is designed for CEPT/CCITT compatible networks. Model 3779D is designed for Bell/Japanese/CCITT compatible networks. Full specifications are contained in the specification booklet.

- The standard unit has VF interfaces for A-A measurements and E&M signaling distortion measurement capability.
- An option adds A-D, D-A and D-D measurements and a single-channel TTL-compatible interface for codec and line card testing.

#### HP 3779C

The HP 3779C performs A-A measurements to CCITT G.712/3 standards. A-D and D-A measurements are performed to CCITT G.714. Multiplex alignment and alarm functions can be tested automatically in D-A mode.

#### HP 3779D

The HP 3779D tests channel bank performance as specified in BSTR PUB 43801.

#### Accessories

- HP 15518A/B: dual-port loop-holding accessory for HP 3776A/B
- HP 15515B: loop-holding unit, 24 mA current sink; WECO connectors
- HP 15512A: 1m length 600 ohm bal cable; Siemens 3-pin connector both ends
- HP 15513A: 1m length 600 ohm bal cable; WECO 310 jack plug both ends

#### Ordering Information

	Price
HP 3779C Primary Multiplex Analyzer (CEPT)	\$25,000
HP 3779D Primary Multiplex Analyzer (Bell)	\$22,050
HP 15512A Cable	\$82
HP 15513A Cable	\$62
HP 15515B Loop Holding Unit	\$330
HP 15518A/B Loop Holding Accessory	\$505

# TELECOMMUNICATIONS TEST EQUIPMENT

## Selective Level Meter and Synthesizer

HP 3586A/B, 3336A/B

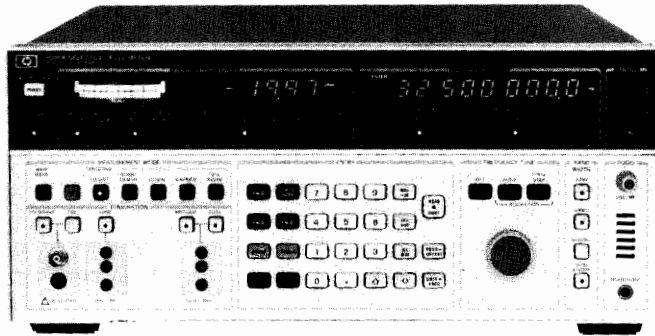

HP 3586A Selective Level Meter (CCITT)



### Selective Level Meter and Synthesizer

The HP 3586A/B Selective Level Meter and HP 3336A/B Tracking Synthesizer offer the high performance necessary to meet demanding requirements in the design, manufacture, commissioning and maintenance of frequency division multiplex (FDM) systems. Features of the HP 3586A/B selective level meter include wideband power measurements and telephone impairment measurement of impulse noise, phase jitter, noise with tone, and signal-to-noise with tone ratio. The wide frequency coverage to 32.5 MHz allows measurements at both voice channel and carrier frequencies.

The HP 3336A/B Synthesizer/Level Generator is an excellent precision tracking signal source for the HP 3586A/B. When the selective level meter (SLM) and synthesizer are in the tracking mode, the frequency of the synthesizer is automatically set to the frequency of the SLM. The HP 3586A and HP 3336A models meet CCITT requirements, and the HP 3586B and HP 3336B models meet North American (Bell) standards.

### HP 3586A/B Specifications

(See data sheet or manual for complete specifications)

#### Frequency

##### Frequency range:

Signal Input	HP 3586A	HP 3586B
75 $\Omega$ Unbalanced	50 Hz to 32.5 MHz	
124 $\Omega$ Balanced		4 kHz to 10 MHz
135 $\Omega$ Balanced		4 kHz to 1 MHz
150 $\Omega$ Balanced	4 kHz to 1 MHz	
600 $\Omega$ Balanced	100 Hz to 108 kHz	

**Center frequency accuracy:**  $\pm 10$  ppm/year

**Frequency counter accuracy:** center frequency accuracy  $+1.0$  Hz

#### Selectivity

**3 dB Bandwidth:** 20, 400, 3100 Hz  $\pm 10\%$

**Noise weighting:** psophometric (3586A) C-message (3586B)

#### Amplitude accuracy: (75 $\Omega$ input)

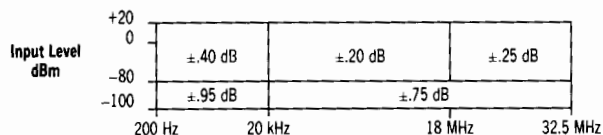

#### Dynamic range

**Noise floor** (full scale setting  $-35$  to  $-120$  dBm)

Frequency	Bandwidth	Noise Level
100 kHz to 32.5 MHz	3100, 1740, 2000 Hz	$-116$ dBm
	20 Hz, 400 Hz	$-120$ dBm
10 kHz to 100 kHz	All	$-105$ dBm

**Harmonic distortion:** 70 dB below full scale  $>4$  kHz on 75  $\Omega$  and 600  $\Omega$  inputs, low distortion mode

**Intermodulation distortion:** two-tone second and third order, separation 7 kHz to 1 MHz, 75 dB below full scale. Either tone  $\geq 10$  MHz,  $-70$  dB.

**Non-harmonic spurious signals:**  $>1600$  Hz offset,  $-80$  dBc.

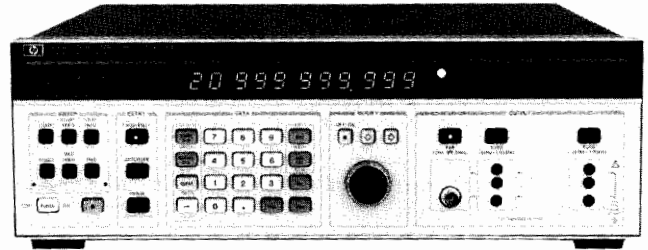

HP 3336A Synthesizer/Level Generator (CCITT)

#### General

**Power:** 100/120/220/240 V,  $+5\%$ ,  $-10\%$  48 to 66 Hz, 150 VA.

**Weight:** net, 23kg (50lb); shipping, 30kg (65lb)

**Size:** 177H x 425.5W x 466.7mmD (7" x 16.75" x 18.38")

### HP 3336A/B Specifications

#### Frequency Range

Signal Output	HP 3336A	HP 3336B
75 $\Omega$ Unbalanced	10 Hz to 20.999 999 999 MHz	
124 $\Omega$ Balanced		10 kHz to 10.999 999 999 MHz
135 $\Omega$ Balanced		10 kHz to 2.099 999 999 MHz
150 $\Omega$ Balanced	10 kHz to 2.099 999 999 MHz	
600 $\Omega$ Balanced	200 Hz to 109.999 999 kHz	

#### Amplitude

**Range:** 75 and 600  $\Omega$  outputs:  $-72.99$  to  $+7.00$  dBm; 124, 135 and 150  $\Omega$  outputs:  $-78.23$  to  $+1.76$  dBm

**Accuracy:** 75  $\Omega$  output, 10 Hz - 20.9 MHz ( $-3$  to  $+7$  dBm)  $\pm 0.15$  dB Opt. 005  $\pm 0.12$  dB

#### Spectral purity

**Phase noise:**  $<-72$  dB for a 3 kHz band, 2 kHz either side of a 20 MHz carrier.

**Harmonic level:**  $-35$  dB, 10 Hz to 30 Hz;  $-50$  dB, 30 Hz to 50 Hz;  $-60$  dB, 50 Hz to 1 MHz;  $-55$  dB, 1 MHz to 5 MHz;  $-50$  dB, 5 MHz to 20 MHz.

**Spurious:** All non-harmonically related signals will be more than 70 dB below the fundamental or  $-100$  dBm ( $-115$  dBm with option 005 except 150 to 600  $\Omega$ ), whichever is greater.

**Phase offset:**  $\pm 719.9^\circ$  with respect to arbitrary starting phase or assigned zero phase.

**Frequency sweep:** linear, logarithmic

**Flatness:**  $\pm 0.15$  dB, 10 kHz  $-20$  MHz

**Modulation:** external AM or PM

#### General

**Power requirements:** 100/120/220/240 V,  $+5\%$ ,  $-10\%$ , 48 to 66 Hz, 60 VA, (100 VA with all options), 10 VA standby

**Size:** 132.6H x 425.5W x 425.5mm D (5 1/4" x 16 3/4" x 16 3/4")

**Weight:** net, 10kg (22lb); shipping, 15.5kg (34lb)

### Ordering Information

**HP 3586A Selective Level Meter (CCITT)** \$12,150

Opt 001 1.6/5.6 mm 75  $\Omega$  Connector +\$103

Opt 004 High Stability Frequency Reference +\$775

**HP 3586B Selective Level Meter (North American)** \$12,150

Opt 001 75  $\Omega$  connector mates with WECO 358A +\$103

and 124  $\Omega$  connector mates with WECO 372A

Opt 004 High Stability Frequency Reference +\$775

**HP 3336A Synthesizer/Level Generator (CCITT)** \$5,660

Opt 001 1.6/5.6 mm 75  $\Omega$  Connector +\$105

Opt 004 High Stability Frequency Reference +\$685

Opt 005 High Precision Attenuator +\$685

**HP 3336B Synthesizer/Level Generator (North American)** \$5,660

Opt 001 75  $\Omega$  WECO 358A, 124  $\Omega$  WECO 372A +\$105

Opt 004 High Stability Frequency Reference +\$685

Opt 005 High Precision Attenuator

#### Price

# TELECOMMUNICATIONS TEST EQUIPMENT

## Microwave Radio Noise and Interference Test Set, Multipath Fading Simulator

HP 3708A, 11757A

555

### HP 3708A

- Carrier tracking maintains accurate & repeatable C/N & C/I conditions
- Fast, alternative residual BER measurement
- Accurate simulation of radio system interference

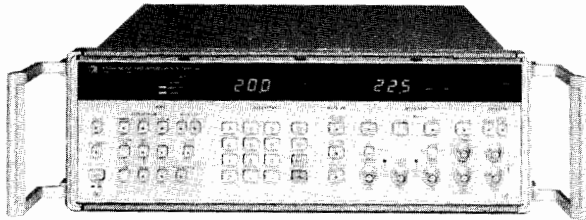

### HP 3708A Noise and Interference Test Set

To minimise lost transmission revenue and the cost of equipment repair, an accurate, overall performance assessment of radio systems is required. This allows potential faults to be corrected before they begin to cause problems. The HP 3708A provides an accurate method of assessing performance of microwave radio and satellite modem systems by providing the Carrier to Noise (C/N) and Carrier to Interference (C/I) conditions necessary to make C/N & C/I vs Bit Error Ratio (BER) measurements.

The instrument is designed for easy access to the IF section of the radio system. The carrier level is monitored and calibrated levels of interference and Gaussian noise are added to stress the system in a controlled way. Accurate and repeatable C/N and C/I ratios can be maintained even in the presence of severe signal variations.

The HP 3708A has the flexibility to accommodate a wide variety of radio designs, a selection of calibrated internal filters giving accurately specified Carrier to Noise ratios in any noise bandwidth. The interference facility allows the addition of a wide variety of interference signals to accurately simulate the effects of radio interference on system performance.

CCIR recommendations 594 recognize the importance of residual BER in assessing the overall performance of digital radio systems. The HP 3708A provides the capability to significantly reduce residual BER measurement time, and increase the confidence in measurement accuracy.

The HP 3708A is equally at home in manufacturing, commissioning or maintenance. Its measurement accuracy allows small changes in performance to be identified with confidence, for correct diagnosis of specific impairments.

#### Options

**Std:** 75 ohm unbalanced connector. Reference tone oscillator frequency is 70/140 MHz.

**001:** 50 ohm unbalanced connector.

**Special options:** Reference tone oscillator frequencies, specifically for portable application of the HP 3708A in determining residual BER, are available on a special order basis.

#### Ordering Information

**HP 3708A Noise and Interference Test Set** \$17,980  
**Opt W30 Extended Repair Service.** See page 723. +\$280

### HP 11757A

- Test equalizers, diversity combiners measure M-curves
- Fixed or moving notch
- Simplified 3-path model
- High performance, lightweight, rugged, easy-to-use
- Optional retrofit for built in M-Curves and internal printer

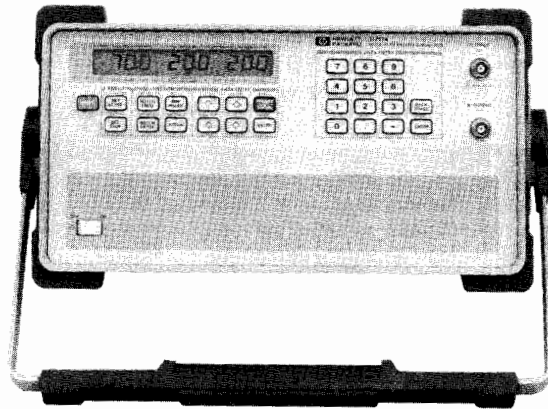

### HP 11757A Multipath Fading Simulator

The HP 11757A Multipath Fading Simulator tests the equalizers and diversity systems in modern digital microwave radios by inserting a notch in the spectrum. The depth, position, minphase/nonminphase, and delay characteristics of the notch can be adjusted. The notch can be stationary to make measurements such as M-Curves (signatures), or it can be swept in depth and position to test radios under dynamic conditions.

The HP 11757A Opt K03 software package is designed for lab and production test of digital microwave radios. When used with the HP 11757A and a bit-error-rate test set, the software calculates and prints M-Curves using an HP Computer. With the HP 3708 Noise and Interference Test Set, the software also makes automatic carrier-to-noise measurements.

A new HP 11757B Multipath Fading Analyzer that offers built in M-Curve and recovery time measurements and an internal printer will be available in Q2 of 1991, making these powerful measurements practical even for field applications. Use the HP 11757A now and reserve the full capabilities of the HP 11757B by simply ordering the HP 11757A K04 retrofit kit.

#### Specifications

##### Notch Frequency

**Range:** Standard: 40 MHz to 100 MHz  
 Opt 140: 110 MHz to 170 MHz

**Resolution:** 100 kHz

**Accuracy:** ±150 kHz

##### Depth

**Range:** 0 to 40 dB

**Resolution:** 0.1 dB

**Accuracy:** 1-20 dB ±0.75 dB  
 21-30 dB ±1.50 dB  
 31-40 dB ±3.00 dB

##### Sweep

**Sweep time:** 100 ms to 99.9 s

**Max. slew rates:** freq: 600 MHz/s, depth: 450 dB/s

**Weight:** 9kg (20lbs)

#### Ordering Information

**HP 11757A Multipath Fading Simulator (70 MHz band)** \$15,000  
**Opt 140 140 MHz band** \$0  
**Opt 147 Both 70MHz and 140 MHz bands** +\$1,000  
**Opt K03 M-Curve Software** Contact Hewlett-Packard  
**Opt K04 B Retrofit Kit** Contact Hewlett-Packard

# TELECOMMUNICATIONS TEST EQUIPMENT

## Digital Radio Constellation Analyzer, Vector Signal Generator

HP 8780A, 8980A, 8981A, 3709B, 15709A

### HP 8780A

- 10 MHz to 3 GHz synthesizer
- BPSK, QPSK, 8PSK, 16QAM, Optional 64QAM
- Burst digital modulation

### HP 8980A

- Analyzes coherent phase and amplitude modulation
- 350 MHz I vs. Q bandwidth
- Markers for measuring phase, amplitude and time
- 12-bit digitizing for HP-IB measurements

### HP 8981A

- Adds 50 MHz to 200 MHz I/Q demodulator
- Demodulates up to 70 MHz communications signals
- $<0.5^\circ$  quadrature error and  $<0.1$  dB amplitude imbalance

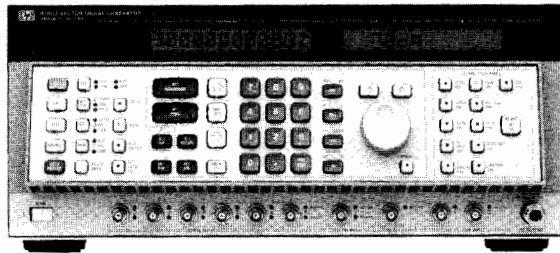

HP 8780A

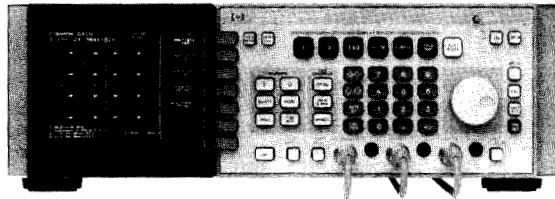

HP 8980A/8981A



### HP 8780A Vector Signal Generator

The HP 8780A Vector Signal Generator is a synthesized source with exceptional modulation for modern digital microwave radio and satellite communications testing. The Vector Signal Generator offers a wide variety of modulation using both digital and analog inputs. It generates standard formats from BPSK to 64QAM and traditional modulation like FM, AM, and pulse, as well as sophisticated complex modulation.

### HP 8980A Vector Analyzer and HP 8981A Vector Modulation Analyzer

The HP Vector Analyzers are two-channel X-Y sampling oscilloscopes designed to analyze the in-phase (I) and quadrature phase (Q) components of modern digital microwave radio signals such as QPSK, 16QAM, and 256QAM. The HP 8981A adds a 50 MHz to 200 MHz demodulator.

### Applications

The vector signal generator, vector analyzer and vector modulation analyzer are well suited to testing modern terrestrial and satellite receivers and transmitters.

The HP 8780A standard modulation patterns — BPSK, QPSK, 8PSK, 16QAM and 64QAM (with Opt. 064) — are easily generated using standard data generators. Asynchronous TDMA modulation can be simulated using the Burst feature along with one of the PSK modulations. A coherent carrier output simplifies quadrature and gain alignment of vector (I/Q) demodulators.

The HP 8980A constellation analysis feature gives non-intrusive measures of closure, quadrature error, and lock angle error for partial response and QAM formats from QPSK to 256QAM. In addition, the HP 8981A extends these measurements to I.F. signals by accurately demodulating them to measure modulators.

For more information about the HP 8780A, HP 8980A and the HP 8981A, refer to the Signal Generator and Signal Analyzer section of this catalog.

### HP 3709B

- For troubleshooting, fine-tuning and preventive maintenance
- Identifies digital radio impairments
- Analyzes magnitude of distortions

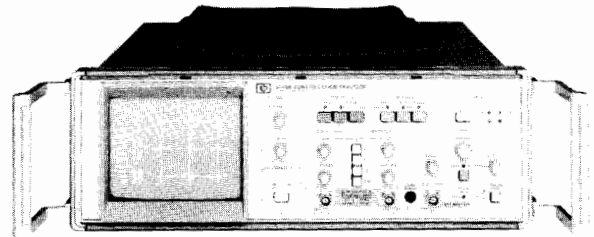

HP 3709B

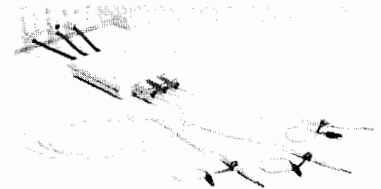

HP 15709A

### HP 3709B Constellation Analyzer

The HP 3709B is used to characterize the performance and condition of digital radios both in-service and out-of-service by analysis of constellation patterns. In addition to displaying constellation patterns, the HP 3709B measures the linear and non-linear distortions revealed by the patterns, and can provide a formatted report containing the pattern and measurement results on a ThinkJet printer.

### Measurements

**Constellation:** amplitude, closure, lock- and quad-angle errors, non-linear distortion (rms, am-am, am-pm).

**Modulation schemes:** QPSK, 16QAM, 64QAM, 256QAM, 9QPR, 25QPR, 49QPR, 81QPR.

### Monitor Points

(1) **I and Q signals:** Any of the above schemes with signal levels in the range 30 to 400 mV p-p across the constellation. (dc offset must be no more than  $0.5 \times$  signal amplitude).

(2) **Clock:** 1 MHz to 80 MHz (100 mV to 1 V p-p)

**Impedance level:** All HP 3709B inputs are 75 ohm terminated.

### Options

**001:** 50 ohm unbalanced input connectors

**003:** Siemens series 1.6/5.6 mm input connectors

**130:** High Impedance Interface Kit. Contains 1 x HP 15709A High Impedance Interface and 3 x HP 10435A 1 metre 10:1 probes

**Special Options:** A low bit rate version (0.1 – 8 MHz) is available to special order.

### HP 15709A High Impedance Interface

This specially designed accessory provides three high impedance, filtered inputs which allow the HP 3709B to be connected to radios without protected 75 or 50 ohm monitor points, using standard oscilloscope passive probes (e.g., HP 10435A 10:1, 1 metre probe).

**Gain:**  $\times 5$  (= overall  $\times 0.5$  gain when used with 10:1 probes)

**Impedance:** 1 M $\Omega$

### Ordering Information

HP 3709B Constellation Display

Opt W30 Extended repair service. See page 723

**Price**

\$13,000

+\$240

# TELECOMMUNICATIONS TEST EQUIPMENT

Digital Radio System, Vector Modulation Signal Generator

HP 11758T, 8782A

557

- Performs 8 different measurements
- Easy to use
- Portable

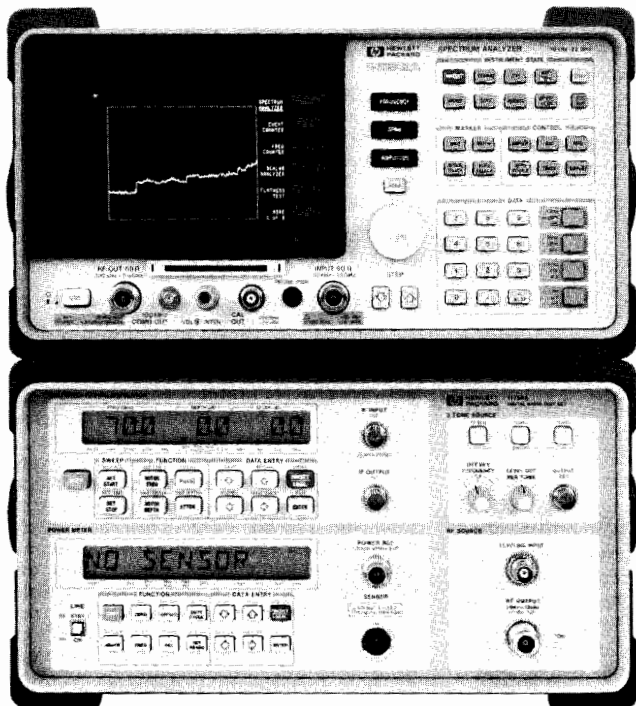

HP 11758T



## HP 11758T Digital Radio Test System

The HP 11758T Digital Radio Test System performs the functions that are most commonly used in testing radios in production, installation, and maintenance. The result is a portable, general-purpose radio testing system that performs all of the following measurements:

- Spectral occupancy and purity
- Nonlinear distortion and intermodulation
- Power measurements
- Frequency
- IF-IF, IF-RF, RF-RF, and RF-IF amplitude flatness
- Sensitivity to multipath fading
- Antenna return loss
- Signal monitoring and logging

### Test Functions

- Spectrum analysis:** 50 kHz to 22 GHz
- Frequency counter:** 10 MHz to 22 GHz,
- IF tracking generator:** 300 kHz to 3 GHz
- Event/Interval counters:** dc to 1.6 MHz
- Power meter and sensor:** 10 MHz to 12 GHz
- Multipath fading simulator:** 40 MHz to 170 MHz
- Three tone IF source:** both 70 and 140 MHz bands available
- RF source:** 3.5 to 6.5 GHz, 10.7 to 11.7 GHz available
- Special RF source options available up to 23 GHz

### Ordering Information

HP 11758T Digital Radio Test System

**Price**  
\$58,000

Contact your HP sales representative for more information about the wide range of options available.

- BPSK, QPSK, 8PSK, 16QAM, 256QAM, digital modulation and burst
- Internal pseudo random binary sequence (PRBS) generator
- AM/SCALAR modulation to simulate flat fading
- Coherent carrier output

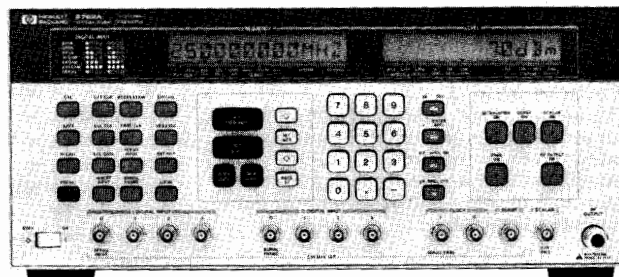

HP 8782A

## HP 8782A Low-Cost Vector Generator

The HP 8782A low-cost vector signal generator offers a wide range of built-in digital modulation from BPSK to 256QAM for microwave terrestrial and satellite communication applications. The 1MHz to 250MHz range covers most of the IF frequencies in commercial receivers. An internal pseudo-random bit sequence (PRBS) generator allows digital modulation without external digital data. The HP 8782A provides economical IF signal generation for R&D and manufacturing. The cost is substantially lower than the cost of the HP 8780A Vector Signal Generator.

### Applications

Use the HP 8782A to align digital radios in manufacturing. The HP 8782A can be used to provide calibrated digital modulations with extremely low quadrature error and amplitude imbalance. It can be used to simulate transmitter impairments, and to test receiver performance margins.

For more information about the HP 8782A, refer to the Signal Generator section of this catalog, page 405.

### Ordering Information

HP 8782A Vector Signal Generator

**Price**  
\$30,300

# DATA COMMUNICATIONS TEST EQUIPMENT

## Protocol Analyzers

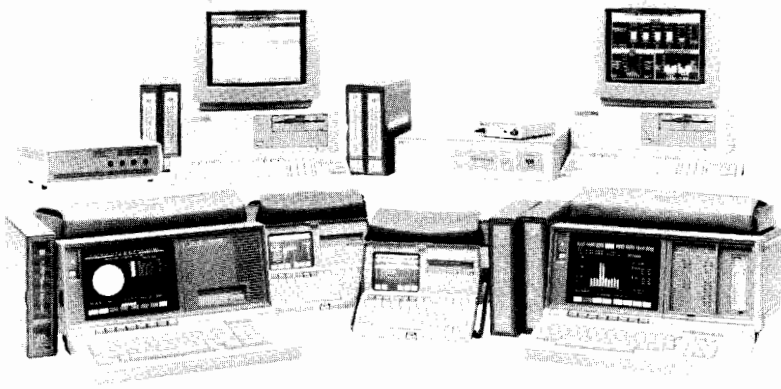

### Protocol analyzers

Hewlett-Packard offers a family of wide area network (WAN) and local area network (LAN) protocol analyzers for testing data communications hardware and software implementations and for troubleshooting data communications networks.

### Protocol Analyzer Testing Solutions

**Monitoring & decoding protocols** spot protocol implementation problems, configuration incompatibilities, communication link failures (corrupted frames, collisions).

**Interactive, programmatic testing** more completely and quickly tests data communications hardware and software implementations, including emulation of error recovery scenarios that are difficult to create.

**Performance analysis** can be used to benchmark product performance and spot degrading network conditions before they result in network failures.

**Traffic generation** to stress-test products and networks.

**Stimulus response testing** verifies the correct operation of networking components and allows quick and easy simulation of faults.

**PC utilities** allow remote control and protocol analysis from a PC.

**Conformance testing** solutions provide conformance acceptance, interoperability, certification and permission-to-connect testing.

**Remote testing** allows technical experts to analyze a remote circuit with the same access and data integrity as if the expert and test equipment were actually at the remote site.

### WAN and ISDN Protocol Analysis

Hewlett-Packard offers a family of five protocol analyzers focused on WAN and ISDN protocol analysis. While maintaining family compatibility, the **HP 4951C**, **HP 4952A** and **HP 4954A/I/AX** are tailored for different environments with different features and characteristics. The analyzers have common operating, setup, mass store, capture buffer, and remote transfer characteristics.

The **IDACOM PT300** and **PT500** support simultaneous multiprotocol, multiprotocol monitoring, emulation, conformance, and performance testing in various interface options. WAN and ISDN interfaces can be combined.

### Local area network (LAN) protocol analysis

HP also offers three versatile local area network (LAN) protocol analyzers to assist you in testing both IEEE 802.3/Ethernet and MAP networks and network devices.

The **HP 4972A** is a high-performance protocol analyzer for managing performance and troubleshooting IEEE 802.3/Ethernet problems. The **HP 4990S** LanProbe distributed analysis system offers a unique approach to maintenance, management and planning of Ethernet local area networks. The **HP 4974S** analyzes IEEE 802.4 networks with layer-by-layer decodes of the MAP 3.0 protocols up through and including layer 7.

### Wide Area Network Protocol Analyzers

	HP 4951C	HP 4952A	HP 4954A/I/AX	PT300	PT500
<b>Weight</b>	6.7 kg (14.8 lb)	7 kg (15.4 lb)	21.17 kg (46.7 lb)	14 kg (30 lb)	20 kg (44 lb)
<b>Mass storage</b>	3.5" diskette	3.5" diskette	3.5" diskette & 20 Mbyte hard disk	Two 3.5" diskettes & 40M bytes <sup>(1)</sup>	
<b>Physical interfaces</b>	RS-232/V.24, V.35, RS-449/422/423, ISDN BRI S/T	RS-232/V.24, V.35, RS-449/422/423, X.21, T1/CEPT, ISDN BRI S/T, ISDN PRI	RS-232/V.24, V.35, RS-449/422/423, X.21, T1/CEPT, ISDN BRI S/T, ISDN PRI, RS-232 for external ISDN access	RS-232/V.24, RS-422/V.35 or RS-449/V.36, V.11/X.21; ISDN BRI S/T (RJ-45 or TAEB+4C), ISDN PRI (RJ-45 and Bantam or DB-9), RJ-14 Voice, serial remote control DB-25, DB-15 External B-Channel access	
<b>Protocols</b>	Async, Bisync, SDLC, HDLC, X.25, SNA, DDCMP, IPARS, ISDN (Q.921 and Q.931)	Async, Bisync, SDLC, HDLC, X.25, SNA, DDCMP, IPARS, X.21, ISDN (Q.921 and Q.931), SS7	Async, Bisync, SDLC, HDLC, X.25, SNA, DDCMP, X.21, ISDN (Q.921 and Q.931), SS7	Async, Sync, X.25, X.25/Q (QLLC/BPAD/DSP), Bisync, SNA/SDLC, X.75, X.21, DDCMP, Teletex/FAX Gr. IV; ISDN (Q.921, Q.931), SS#7, BOP, COP.	
<b>ISDN testing</b>	BRI S/T monitor, INFO states LEDs, Q.921 and Q.931 decode.	BRI S/T single channel, INFO states LEDs, monitor/simulate, Q.921 and Q.931 decode, ISDN PRI single channel, rate adaption/drop and insert, G.821 BERT	BRI S/T dual channel, INFO states LEDs, monitor/simulate/emulate, Q.921 and Q.931 decode, ISDN PRI dual channel, rate adaption/drop and insert, ISDN interactive tester, NET 3 certification	See note 2 below. Layer 3 message sets supported for basic rate and primary rate: AT&T, CCITT 1988, FTZ, NTT, NT and for basic rate: NIU Forum, CNET.	
<b>X.25 testing</b>	X.25 decode, Link level statistics.	User-customizable X.25 decode with facilities field decode, X.25 test library, and link level emulator. Link level statistics.	X.25 decode with facilities field decode, X.25 interactive emulation, X.25 statistics. NET2 certification.	Multi-link X.25 decode, Facility field decode, Link and Packet level emulator, Link and Packet Level Statistics, X.25 test library, custom test scripts. Multiprotocol option.	
<b>SNA testing</b>	SNA FID 2 decoded. SNA/Bisync 3270 tester. Link level statistics.	All SNA FID types decoded. User-definable data display. SNA/Bisync 3270 tester. Link level statistics.	All FID types decoded. SNA bind decode. SNA development language with emulation 3270 device exerciser, LU 6.2 node exerciser. SNA/Bisync statistics.	FID types decoded. Simultaneously emulates up to 32 stations. Link-level emulation of controller. SNA statistics	
<b>Programming</b>	Monitor/simulate menus. Trigger/trap datacom events. Count, time, alarm. Set leads, send strings.	Monitor/simulate menus. All HP 4951C features plus subroutines, softkey triggers display messages	Monitor/simulate menus. DataCommC (full K & R C programming language), SNA development language. X.21 state simulator language, interactive testers (for X.25, ISDN)	Custom test script generation via finite state machine concept. Run-time library for all protocols. Customize ISDN L3 message sets. "C" Programming Software. Header Files for X.25, SNA/SDLC, SS#7 and ISDN.	
<b>Conformance and Certification Testing</b>	not applicable	not applicable	NET2, NET3	X.25: DDN, FIPS100, CTS-WAN, NET2, COS XCTS, Facilities Tests, ISO 8882 (U.S. GOSIP); ISDN: NET3 L2, ACT23 L2, VN2, CTS-WAN L3, AT&T CPE PRI, X.28/X.29/X.3, SNA Verification	
<b>Price (w/RS-232/V.24)</b>	\$4,690	\$9,200	\$17,635	Contact HP	

<sup>(1)</sup>PT 300-1 diskette, PT 500-2 diskettes

<sup>(2)</sup>The PT 300 and PT 500 offer 13 interface options for multiprotocol to operation.

# DATA COMMUNICATIONS TEST EQUIPMENT

Protocol analyzers

HP 4951C, 4952A

559

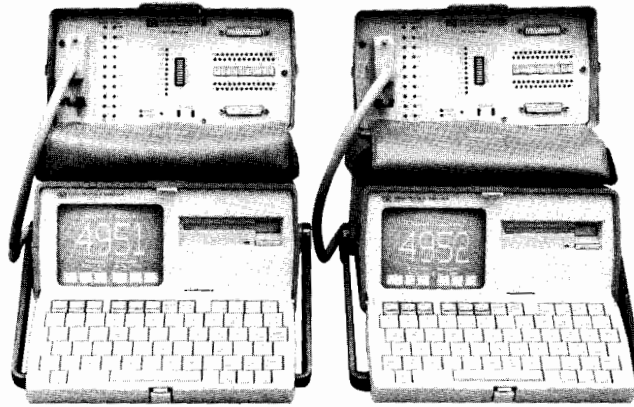

## HP 4951C and HP 4952A protocol analyzers

The HP 4951C (19.2 kbps) and HP 4952A (64 kbps) are portable protocol analyzers used for troubleshooting during installation, maintenance and design of data communication networks and equipment. These analyzers allow you to monitor and decode data transmissions, measure vital link statistics (such as, utilization, errors), test remote facilities from your location, simulate network components, and perform bit error rate tests. Protocols that can be tested include ISDN, SDLC (NRZI), HDLC, X.25, SNA, CCITT #7, DDCMP, Async, Bisync, X.21, and user-defined protocols.

### HP 4951C and HP 4952A features and benefits

**Autoconfigure** to automatically determine line parameters and to monitor data with the press of a key.

**Bit error rate testing (BERT)** to quickly determine the quality of your line.

**3 1/2-inch diskette** to store 613 Kbytes of data, timing, lead status, programs, and configurations.

**Asynchronous terminal emulator** to eliminate the need to carry both a protocol analyzer and a terminal into the field.

**Softkey-driven menus** to make setup and programming fast and easy with no cryptic commands to remember.

**RS-170 video port** to view data on a larger display.

**Printouts** to all RS-232/V.24 ASCII printers.

**PC Utilities** to remotely control and analyze protocol analyzer data from a PC

### Additional HP 4952A features and benefits

**64 kbps testing.**

**3/4 Mbyte extended volatile RAM capture buffer** (option 002).

**128 Kbyte nonvolatile application storage** (option 002).

**Unattended remote testing.**

**Cursor timing** to allow timing measurements to be made quickly, without the need to write a program.

**Enhanced programming features:** run-time user comments, softkey triggering, and subroutines.

**Run-time buffer data filtering** to maximize capture buffer.

**Selective store to disk** to capture only events of interest.

**Copy disk utility** to quickly duplicate disks (requires Opt 002).

### Data communications test library

Standard with every HP 4951C and HP 4952A comes a library of 58 prewritten general-purpose monitor and simulate tests, including installation and acceptance tests for printers and terminals to help you diagnose common datacomm problems quickly and easily. The tests are on a 3 1/2-inch diskette and can be tailored for special configurations and applications.



### ISDN solutions

A complete series of highly portable (12 oz) ISDN pods have been created for the HP 4951C and HP 4952A. For the HP 4951C and HP 4952A, a basic rate monitor pod provides quick level-1 problem solving through LEDs, several switch- and country-specific decodes, and four user-definable display formats. For the HP 4952A, pods are also available for basic rate simulation, and for use on 1.544 Mbps and 2.048 Mbps primary rate ISDN/T1 networks. The primary rate pods provide the same features as the basic rate monitor pod, plus drop and insert capability.

## X.25 and SNA link-level performance analysis

Link-level statistics packages transform the instruments into statistical performance analyzers for the link level (level 2) of SNA and X.25 networks (SDLC and HDLC). The HP 18333D (HP 4951C) and the HP 18264A (HP 4952A) provide a quick and efficient means to determine the performance of a network. Statistics are shown real-time, and they can be stored to disk for review at a later time.

## 3270 installation and maintenance

The HP 18332D (HP 4951C) and HP 18263A (HP 4952A) 3270 installation and maintenance software packages provide easy, automatic, off-line testing of multiple 3270 clusters by emulating many of the functions of a host computer.

## X.25 troubleshooting

Both analyzers provide X.25 troubleshooting. In addition, the HP 18266A enhanced X.25 analysis package (HP 4952A only) allows you to create five custom X.25 decode displays, and provides a display to decode all fields of each packet including facilities, calling/called addresses, cause and diagnostic codes, registration and call user data. The HP 18267A X.25 test library and emulator (HP 4952A only) provides a level-2 emulator, and a library of prewritten X.25 tests.

## SS#7 testing

The HP 18273A provides SS7 testing for the HP 4952A. Layer 2, 3, and 4 message fields are decoded into an easy-to-read format to make analysis quick and efficient. For customized and national variations of SS#7, hex and mnemonics for user parts and message types can be user-defined.

## G.821 BERT testing

G.821 BERT, the error performance specification for ISDN and other protocols recommended by the CCITT, is supported by the HP 18269A G.821 BERT application for the HP 4952A so that you can confidently determine the quality of your lines.

## Physical specifications

**Size:** 160H x 279W x 343mmD (6.3" x 11" x 13.5")

**Weight:** HP 4951C: net, 6.7kg (14.8lb); shipping, 12.2kg (27lb)

HP 4952A: net, 7kg (15.4lb); shipping, 12.5kg (27.6lb)

## Ordering information

**HP 4951C protocol analyzer** (requires interface pod) \$3,980

**HP 4952A protocol analyzer** (requires interface pod) \$7,040

**Opt 002** extended memory plus +\$1,500

**Interface pods** are available for ISDN, RS-232/V.24, RS-449/422A/423A, X.21, and V.35 from \$650 to \$2,500

**Opt W30** extended repair service (see page 723)

**Software packages** for SNA, X.25, DDCMP, and ISDN are available for the HP 4951C \$350

**A typical ISDN solution** - HP 4952A, Opt 002, and a primary rate interface pod (HP 18282A/18283A/18284A) \$11,040

**A typical X.25 solution** - HP 4952A, Opt 002, RS-232 pod, SNA and X.25 link level performance analysis and the X.25 test library and emulator \$10,200

**A typical SNA solution** - HP 4952A, Opt 002, RS-232/V.35 combo pod, SNA and X.25 link level performance analysis and the 3270 installation and maintenance application \$10,755

Contact your local Hewlett-Packard sales office for information on the availability of different options, related products and detailed configuration and ordering information (see page 737).

☎ For same day shipment, call HP DIRECT at 800-538-8787.

# DATA COMMUNICATIONS TEST EQUIPMENT

## Protocol analyzers

HP 4954A/I/AX



### HP 4954A protocol analyzer

The HP 4954A is a high performance, multiprotocol, expandable protocol analyzer for designing data communications products, solving complex networking problems, and analyzing network performance. Both the HP 4954I solution for ISDN testing and the HP 4954AX solution for X.25 testing are based on the HP 4954A protocol analyzer and the powerful DataCommC programming language.

#### HP 4954A features and benefits

**Multiprotocol testing** capabilities allow monitoring, analysis, and simulation of popular protocols, including X.25, SNA/SDLC, bisync, async, DDCMP, X.75, HDLC, BSC-framed X.25, and character-oriented synchronous protocols. ISDN, X.21 and SS#7 support is also available through easy to use application software.

**The internal 256 Kbyte data capture buffer** can be expanded through the integral hard disk up to **20 Mbyte**. Even greater data capture buffers are possible with external HP-IB disk drives.

**Programming flexibility** through high-level protocol analysis and simulation is a standard capability of the HP 4954A. Custom measurements and tests are easy to perform with softkey-driven entry of monitor and simulation programs with triggering based upon datacomm events. The DataCommC programming language supports more advanced testing.

**PC Utilities** to remotely control and analyze protocol analyzer data from a PC.

#### DataCommC programming language

**Testing power and flexibility** are supported by the HP 4954A's DataCommC programming language, which is a version of the standard Kernighan and Ritchie 'C' language enhanced with data communications libraries. DataCommC includes an interactive tester, a full-screen windowing text editor, terminal emulator, Kermit file transfer protocol, compiler, linker, and a multitasking operating system. A decode platform provides screen and keyboard handling functions to simplify analysis of custom protocols.

**DataCommC interactive tester**, which interprets keyboard commands, simplifies testing of protocol state machines. The interactive tester allows users to interactively send test stimuli to the implementation under test (IUT), examine decoded data on the screen, and respond to the data sent by the IUT with further stimuli — without the need to edit, compile, and link a DataCommC program. From the interactive tester, over 70 data communications functions can be executed. Macros, sequential lists of functions, can be created and executed.



### HP 4954AX X.25 protocol analyzer

The HP 4954AX provides the powerful testing tools needed by developers of X.25 equipment. The HP 4954AX consists of the HP 4954A with extended memory, DataCommC programming language, and the HP 18321A X.25 test environment. Optional software packages are the HP 18322A X.25 certification test suite and the HP 18370A X.25 network performance analyzer.

### X.25 test environment

The HP 18321A X.25 test environment offers the following important features for X.25 testing:

- The **X.25 emulator** offers 5 emulation stages to meet various testing needs: layer 1, partial layer 2, full layer 2, and two different layer 3 stages.
- The **X.25 interactive tester** provides X.25-specific functionality for in-depth protocol state machine testing.

### X.25 certification test suite

Verification of an X.25 implementation is greatly simplified with the HP 18322A X.25 certification test suite. This easy-to-configure, menu-driven product tests compliance with the NET-2 (Normes Europeennes de Telecommunications) specifications for X.25. Eighteen European PTT's agreed to require passing of NET-2 tests at official test centers as of July 1, 1990.

### X.25 network performance analyzer

The HP 18370A X.25 network performance analyzer is an HP 4954A software solution that gathers statistical information about the performance of an X.25 data link. Statistics on throughput, utilization, bad FCS's, reject frames, and many other parameters are available in both tabular and graphical format.

### SNA testing

The HP 18360A SNA emulation language is an HP 4954A software solution that is designed to aid in the development of devices that are compatible with IBM's Systems Network Architecture (SNA). The HP 18360A consists of an SNA-specific programming language plus complete link and path control emulators. The HP 18361A SNA 3270 device exerciser and HP 18362A LU6.2 node exerciser are user-modifiable tests written in the SNA emulation language to thoroughly test 3270 and LU6.2 devices.

### SNA/Bisync network performance analyzer

The HP 18371A SNA/bisync network performance analyzer consists of two software programs designed to aid in the management of IBM and IBM-compatible data networks. Statistical information can be gathered about the performance of an SNA or bisync data link. When analyzing an SNA data link, statistics on session control BIU, link setup, binds, unbinds, and many other parameters are available in both tabular and graphical format. Similar measurements are provided when analyzing bisync data.

### X.21 testing

The HP 18352A X.21 state simulator is an HP 4954A software solution that is specifically designed to aid in the development of X.21 DTEs and DCEs. It consists of an X.21-specific softkey-driven programming language combined with a state level decode. Included with the X.21 state simulator is the X.21 DTE analysis pack, a set of user-modifiable tests written in the X.21 state simulator language that thoroughly tests an X.21 DTE for protocol conformance.

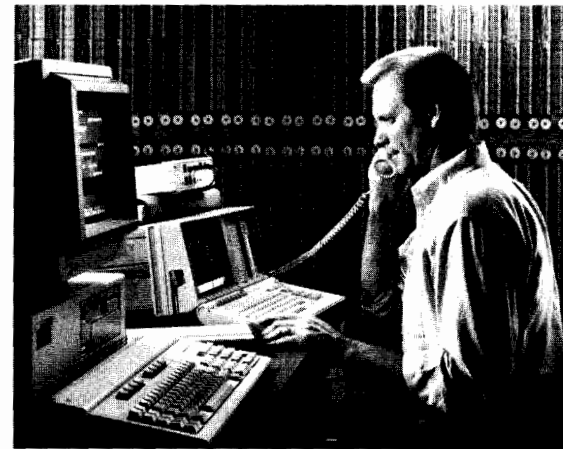

The HP 4954A protocol analyzer is a powerful tool for solving complex network problems, analyzing network performance, and protocol testing in the development of data communications products.



# DATA COMMUNICATIONS TEST EQUIPMENT

Protocol analyzers

HP 4954A/I/AX continued

HP 4974A

561



## HP 4954I ISDN protocol analyzer

The HP 4954I is optimized for both R & D testing of ISDN equipment and solving complex networking problems encountered in ISDN installation and maintenance. The HP 4954I is composed of the HP 4954A with extended memory, DataCommC programming language, and ISDN hardware interface for basic and/or primary rate access, as well as ISDN application software. Both T1 (1.544 Mbps) and CEPT (2.048 Mbps) ISDN primary rate interfaces are supported. The HP 4954I supports many features for high-performance ISDN testing:

**Multiple channel analysis** allows troubleshooting where timing between channels is critical.

**ISDN interactive tester** provides ISDN-specific functionality, the ability to call DataCommC programs, and softkey tree definition for customized ISDN testing. The LAPD emulator can be invoked from the ISDN interactive tester, allowing the user to concentrate on layer-3 testing.

**Layer 1 LED's** are used to show configuration and line quality problems at a glance.

**Rate adaption analysis** of the HP 4954I supports non-ISDN devices, which is important in the transition to ISDN.

**Device emulation** simplifies testing by automating either the NT (network termination) when testing a TE (terminal equipment) implementation or the TE when testing an NT implementation.

**The ISDN Automonitor** program provides automatic selection of ISDN B channels which are actively carrying data and voice traffic.

**ISDN NET 3 Certification** provides menu-driven, easy-to-use testing for protocol verification of an ISDN implementation.

### Physical specifications

**Size:** 196H x 425W x 565mmD (7.7" x 16.7" x 22.2"), rack-mountable

**Weight:** 21.17kg (46.7lb)

### Ordering information

**HP 4954A** protocol analyzer (requires interface) \$16,470  
 Opt 001 extended memory +\$1,500

### Interfaces (required for on-line analysis)

HP 18135A RS-232C/V.24 interface \$1,165  
 HP 18136A RS-449/422A/423A interface \$1,165  
 HP 18137A V.35 interface \$1,465  
 HP 18139A MIL-188C interface \$1,165

### ISDN Interfaces (includes ISDN software)

HP 18356A ISDN BRI channel selector \$4,800  
 HP 18357A ISDN T1 PRI channel selector \$7,200  
 HP 18358A ISDN T1 PRI + BRI channel selector \$10,000  
 HP 18359A ISDN CEPT PRI channel selector \$7,200  
 HP 18366A ISDN CEPT PRI + BRI channel selector \$10,000

### Application Software

HP 18320A DataCommC programming language \$2,020  
 HP 18321A X.25 test environment \$2,000  
 HP 18322A X.25 certification test suite \$1,500  
 HP 18352A X.21 state simulator \$4,040  
 HP 18355A CCITT#7/CCS7 analysis \$1,600  
 HP 18360A SNA emulation language \$2,500  
 HP 18361A 3270 device exerciser for 18360A \$1,000  
 HP 18362A SNA LU6.2 node exerciser for 18360A \$2,000  
 HP 18363A password security \$450  
 HP 18369A asynchronous terminal emulator \$300  
 HP 18370A X.25 network performance analysis \$1,200  
 HP 18371A SNA/BSC network performance analysis \$1,200

**A typical network management solution - HP 4954A, RS-232C interface, X.25 network performance analysis or SNA network performance analysis** \$18,835

**A typical SNA development solution - HP 4954A, RS-232C interface, SNA emulation language, 3270 device exerciser, SNA LU6.2 node exerciser** \$23,135

**A typical X.25 development solution - HP 4954AX, Opt 201 (X.25 certification test suite), RS-232C interface** \$24,655

**A typical ISDN basic rate solution -HP 4954I, Opt 200 (BRI interface and software)** \$24,790

**A typical ISDN basic and primary rate solution - HP 4954I, Opt 203 or 204 (BRI + PRI interface and software)** \$29,990

**Opt W30 extended repair service (see page 723)** \$310

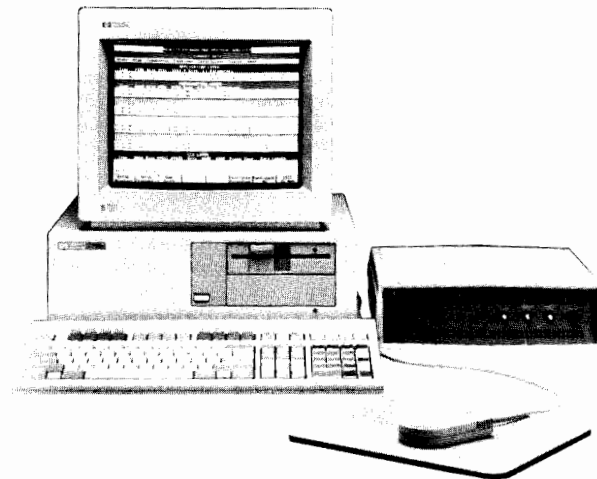

## HP 4974A MAP protocol analyzer

The HP 4974A is a high-level MAP protocol analyzer for IEEE 802.4 broadband and carrierband networks that run MAP 3.0 protocols. For total HP quality and support, the HP 4974A should be installed in an HP Vectra PC. It is also available as a card to be installed in selected IBM-AT compatibles.

### HP 4974A Features and benefits

**OSI protocol decodes** for all MAP 3.0 protocols, with detailed displays from the LLC layer through the application layer of the MAP protocol stack are provided. This feature provides unprecedented capabilities to engineers and network managers involved in MAP development and installation and maintenance.

**Frame capture** from all active nodes along with monitoring of single conversation between two MAP devices, filtering out additional network traffic.

**2Mbyte memory buffer** (expandable to 8 Mbyte) to enable long exchanges or large file transfers to be captured, logged to either the large Winchester drive or floppy disk. Data can be examined online or from a previously stored buffer file or disk.

### Applications

The HP 4974A MAP protocol analyzer provides an independent, unbiased view of protocol events and a summary representation of protocol data unit header values. This time-saving information is helpful in network troubleshooting situations. Interoperability testing is easier when protocol data units from two dissimilar devices are viewed in a consistent format. Communications software debugging is faster when protocol transactions can be seen as they appear on the network. Configuration and integration of equipment is simplified by viewing exchange negotiations and configuration values as they affect your network. Common protocol and configuration mismatches are easily identified, often saving hours of guesswork and experimentation.

Protocols supported include IEEE 802.2 Link Layer, ISO Network, ISO Transport Class 4, ISO Session, ISO Presentation, ACSE, FTAM, MMS, DS, and NM.

### Ordering information

The HP 4974A can be ordered as a complete system, or the MAP interface equipment and software can be ordered for installation in your existing HP Vectra ES/12 personal computer, IBM PC-AT computer, or Compaq III portable computer.

**HP 4974A** protocol analyzer (requires PC) \$18,660

Includes: MAP protocol analysis software, MAP network interface card, and MAP network broadband and carrierband interface pods.

Contact your local Hewlett-Packard sales office for information on the availability of options, related products and detailed configuration and ordering information (see page 737).

# DATA COMMUNICATIONS TEST EQUIPMENT

## Conformance Tester/Protocol Analyzer IDACOM model PT500

### PT500, PT300 Protocol Analyzers

The IDACOM PT500 and PT300 are true multi-port, multi-channel, multi-protocol testers that offer a combination of ISDN basic, primary rate and WAN interfaces for data communications product development, conformance testing, and performance testing. The PT500 is also the same test engine used by the conformance test centers worldwide as Conformance Test System.

### Features

**High-speed multi-processors** make up a parallel application processing environment which supports simultaneous monitoring and/or simulation/emulation of up to six independent channels.

**Dynamic on-line control** allows operators to change test parameters while a program is running, without rebooting, reloading, or reconfiguring.

**RTP remote test package** makes existing capabilities available remotely, distributing test and analysis functions throughout remote sites.

**Custom test script development** is provided via a finite state machine concept with access to an extensive runtime library.

### Conformance Testing

The IDACOM Conformance Test System is a software package that runs on the PT500 or the PT300. Common Control software offers a consistent user interface among test suites. IDACOM provides executable test suites specified by recognized testing authorities and an environment for the development of test cases. The test suites can be used during and after the development of data communications products. During the implementation phase, the developer simply executes the conformance tests immediately after each feature is implemented to verify the implementation of that feature. During test phase, a complete set of tests can be executed against the product. A detailed test report shows the exchange of data and the verdict. For subsequent maintenance, the test suite should be executed for each new hardware and software release.

### ISDN Basic, Primary Rates and WAN Testing

This configuration supports independent and simultaneous monitoring and/or simulation and emulation at the PRA(primary rate), BRA(basic rate) and R interfaces. An application example is PABX development, where all network and user functions can be tested simultaneously by simulating or monitoring all voice and data calls throughout the network.

### ISDN Basic Rate and WAN Testing

This configuration supports independent and simultaneous monitoring and/or simulation and emulation at the ISDN BRA(basic rate) and R interfaces. For example, it can simplify the complex testing of ISDN TAs through logical testing at the R and the S interface points simultaneously.

### ISDN Basic Rate Testing

The Dual BRA configuration supports simultaneous emulation and/or monitoring of two completely separate S/T buses. The PT500 can simulate the ISDN network including up to 16 links (8 per S-bus) and 4 B-Channel services.

### WAN Testing

The PT500 provides extensive monitoring and emulation packages for WAN protocols such as X.25, SDLC/SNA, BSC3270, etc. Other high-performance analysis programs include X.25 load generation, X.25 network performance, SNA network performance, and SS#7 simulation/monitor, etc. The dual WAN configuration provides two independent WAN ports. A dual WAN unit can emulate a different protocol on each port, while both ports monitor and display their own traffic.

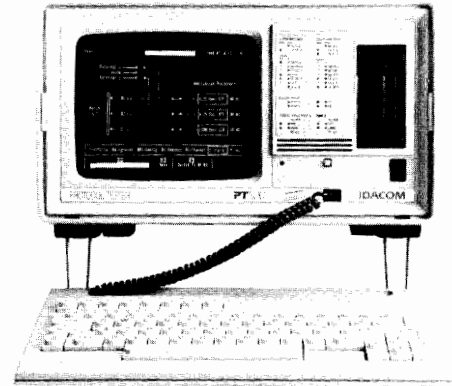

IDACOM PT500

### Voice Support (ISDN configuration)

B-Channel telephone access is provided via codec. An internal call progress tone generator provides realistic network emulation.

**Display options:** Multi-level decoded character, complete, short, or split screen.

**Protocols:** X.25, X.25/Q (QLLC/BPAD/DSP), ISDN Q.921/I.441, Q.931/I.451, BSC 3270, SNA/SDLC, X.75, X.21, DDCMP, Teletex/FAX Gr. IV, LAPD/X.25, SS#7, Sync, Async, COP, BOP

### Data Transfer Rate

**Monitor:** 256 kbps

**Emulation:** D-Channel: 16 kbit/s (BRA), 64 kbit/s (PRA)

B-Channels: 64 kbit/s per channel

WAN: up to 128 kbit/s

### Interface Ports

**ISDN BRA:** Dual RJ-45 (CCITT) or TAE8+4C (German PTT) connectors including a connector for external B-Channel for each BRA port

**ISDN PRA:** Dual RJ-48 and Bantam (T1) or DB-9 (CEPT), with external clock sync and B-Channel access

**WAN:** RS-232C, V.35 or V.36(RS-449/422) and V.11/X.21 per port

### Display Modes

Decoded character, Hex, JIS8, ASCII, EBCDIC, T.61

### Physical Specifications

**Display** PT500 High resolution 9" color monitor

PT300 9" monochrome (ext color display)

**Size** PT500: 22.0H×38.0W×47.5 cmD (8.66"×14.96"×18.7")

PT300: 22.0H×38.0W×36.0 cmD (8.66"×14.96"×14.17")

**Weight:** PT500: 20 kg (44 lb); PT300 14 kg (30 lb)

**Data to disk Storage:** 64 to 30 Mbytes configurable

**Mass:** PT500 40 Mbyte hard disk, 2 × 3.5" flexible drives

PT300 40 Mbyte hard disk, 1 × 3.5" flexible drives

### Configurations

PT500 D-Channel

PT500 WAN

PT500 BRA

PT500 PRA

PT500 Dual WAN

PT500 BRA/WAN

PT500 PRA/WAN

PT500 Dual BRA

PT500 PRA/BRA/WAN

PT300 D-Channel

PT300 WAN

PT300 BRA

PT300 PRA

PT300 Dual WAN

PT300 BRA/WAN

### Ordering Information

Please call your local HP sales office (see page 737).

# DATA COMMUNICATIONS TEST EQUIPMENT

Remote Network Testers

IDACOM model RTM, RTA

563

## Software Programs for PT500, PT300 and RTA

### X.25

- X.25 Monitor
- X.25/Q Monitor (QLLC/BPAD/DSP)
- X.25 Emulation
- X.25 Load Generator
- X.25 Network Performance Measurement Software

### X.25 conformance testing

- Common Control Software
- DDN Test Suite
- CTS-WAN B-Channel/WAN Test Suite
- NET2 Test Suite (incl. Annex F and G)
- ISO 8882 (U.S. GOSIP)
- Facilities Test Suite
- COS XCTS (includes software for SUN Host, and PT remote, plus the X.25 Conformance Test Suite)
- X.25 Test Suite (standalone version using the COS X.25 Conformance Test Suite)

### X.25 test case specifications

- NET2 for L2 and L3 (SDL)
- CTS-WAN L2 (SDL) and L3 (TTCN)

### ISDN

- ISDN D-Channel Monitor (BRA, PRA with X.25 PLP)
- ISDN D-Channel Emulation (BRA, PRA with X.25 PLP)

### ISDN conformance testing

- Common Control Software
- NET3 L2 Test Suite
- ACT23 L2 Test Suite
- VN2 Test Suite
- CTS-WAN L3 D-Channel Test Suite
- AT&T CPE PRI Test Suite

### SS#7

- SS#7 (ANSI) Monitor
- SS#7 (CCITT) Monitor
- SS#7 (Telecom Canada) Monitor
- SS#7 (ANSI) Simulation
- SS#7 (CCITT) Simulation
- SS#7 (Telecom Canada) Simulation

### SNA/BSC

- SNA/SDLC Monitor, SDLC Emulation
- BSC 3270 Monitor, BSC 3270 Emulation
- SNA Network Performance Analysis
- SNA Verification

### Others

- X.21 Monitor, X.21 Emulation
- X.75 Monitor, X.75 Emulation
- Teletex/FAX Group IV Monitor
- DDCMP Monitor
- Remote Test Package
- R-FILEX®
- X.28/X.29/X.3 Conformance Test Suite

Each IDACOM software package supports automatic decode, real-time display, multiple display formats, data capture to RAM or directly to disk, and printing of data or reports. A built-in test manager supports dynamic interactive monitoring with user-defined test sequences.

### Ordering Information

Please call your local HP sales office (see page 737.)

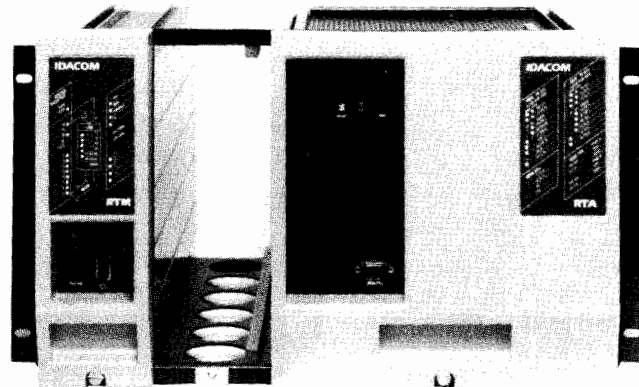

IDACOM RTM and RTA

### IDACOM RTM (Remote Transparent Monitor)

The IDACOM RTM transports live data and control lead information from a remote test site to the network control center (NCC) in real-time, with the same data integrity and in the same time correlation as it occurs. The experts at the NCC can analyze a network problem as if they were at the remote location.

RTM consists of monitor and regeneration equipment connected by a dedicated or switched circuit. Generally, the monitor function is at the remote site, and the regeneration function is at the central site.

### Features

**Protocol independent:** the circuit under test monitored by the RTM can be any protocol at up to 64 kbit/s synchronous and 19.2 kbit/s asynchronous in selected speed increments.

**Maintains data integrity and time correlation:** the RTM ensures time correlation; the data is regenerated at the central location in its original sequence and maintains the same integrity as if the line under test were not remote.

**Error detection:** the RTM is a "smart pipeline", a data transport system with built-in error detection. It accommodates for normal noise on the link, so nothing interferes with the original data. It automatically signals the operators at remote and central sites when major disturbances occur.

**Voice:** direct phone communication between the remote and central site is provided.

**Transparent monitor medium:** the RTM can act as a transparent communication link between the remote and central test sites.

**Command port:** Using the command port, the operator can set the RTM to either monitor or regeneration and run diagnostics, obtain reports on link statistics, and reset link error counters.

**Automatic clock adjustments:** The RTM automatically adjusts to synchronous clock rates. It also recognizes the lack of clocks on a line and provides an internal clock to sample the line at a suitable rate.

**Dial-up modem:** The RTM has an on-board dial-up modem for maintenance and software updates.

### IDACOM RTA (Remote Test and Analysis)

The IDACOM RTA is a flexible and programmable test engine for remote test and analysis. It has similar capabilities as the PT500, including multi-channel support but without built-in CRT since it is not required at most remote sites. The test experts at the central site can control RTAs located at the remote sites to perform testing and analysis on remote equipment or circuits. Multiple applications running at the remote site can be viewed from the central tester. Custom test suites can be generated at the central site and down loaded to the remote site for testing. The RTA, PT500 and remote RTAs share the same user interface.

# DATA COMMUNICATIONS TEST EQUIPMENT

## Protocol analyzers

HP 4972A



### HP 4972A LAN protocol analyzer

The HP 4972A is a protocol analyzer for Ethernet, IEEE 802.3 and StarLAN local area networks. The analyzer captures and displays frames integral to communications between networked systems and devices. Messages can also be transmitted in order to test system responses, identify active stations, or simulate heavily loaded network conditions. Statistical measurements provide information on fundamental parameters which instantly characterize network performance.

The HP 4972A resolves problems quickly and provides fundamental information for optimizing networked systems. Its many powerful features can be used to:

- Resolve communication problems and verify solutions.
- Identify addressing problems and system incompatibilities.
- Analyze the behavior and performance of networked systems.
- Characterize network usage and system efficiency.
- Fully test products prior to network installation.

### Features and benefits

**Statistical measurements** (to help isolate problems quickly.)

**Custom-designed front-end hardware** to completely and accurately capture data under all network conditions.

**Dual LAN co-processors** to transmit and receive simultaneously.

**Programmable filters and messages** to do stimulus/response and custom testing.

**20 Mbyte hard disk and 640Kbyte flexible disk drive** to store tests and data.

**Controllable** via RS-232/V. 24 link by another HP 4972A or an IBM-compatible PC to do remote testing.

### Media-access layer statistics

Network activity is easily observed with this powerful set of measurements included with the HP 4972A. By profiling and monitoring fundamental MAC-layer parameters, problems are noticed quickly, trends become apparent, network usage is quantified, active stations are identified, and peak loading periods are determined. Devices may be tested under simulated network loads with the traffic generator running in the background. These measurements are displayed in both graphical and tabular formats.

### Key measurements include:

- Utilization, errors, collisions, and frame-type analysis.
- Frame activity and error rates for physical addresses and logical connections.
- Background traffic generator with variable messages.
- Alarms, measurement autosequencing and data logging.

### Network performance analysis

Network performance analysis (statistical) applications for the HP 4972A measure network and transport layer parameters for TCP/IP and DECnet networks. With these measurements, the behavior and efficiency of networked applications becomes readily apparent. The information is presented in both graphical and tabular formats.

### TCP/IP network performance analysis measurements:

- Distribution of frames by port type.
- System activity by IP address.
- Throughput, retransmissions, response time, packet lengths and send windows for specified conversations.

### DECnet network performance analysis measurements:

- Distribution of frames by message type.
- System activity by DECnet address.
- Throughput, retransmissions, response time and packet lengths for specified conversations.

### Protocol interpreters

Protocol interpreter applications present protocol header information in an easily understood manner. Interpreters are available on the HP 4972A for TCP/IP, DECnet, Novell's NetWare, Sun Microsystems's NFS, XNS, and ISO protocols.

Features of the protocol interpreters include:

- Header information is displayed in common and easily recognized formats.
- Incorrect or invalid field values are highlighted.
- Name lists assign logical names to numeric addresses.

### Physical specifications

**Size:** 270H x 430W x 570mmD (11" x 17" x 22")

**Weight:** net 21kg (46lb); shipping 27kg (60lb)

### Ordering information

<b>HP 4972A LAN protocol analyzer</b>	\$18,540
Opt 001 RGB color output	+\$1,500
Opt 002 RS-232/V. 24 remote interface	+\$600
Opt 005 StarLAN interface	+\$500
Opt W30 extended repair service (see page 723)	
<b>HP 18221A TCP/IP protocol interpreter</b>	\$960
<b>HP 18222A TCP/IP network performance analysis</b>	\$960
<b>HP 18223A XNS protocol interpreter</b>	\$960
<b>HP 18224A DECnet protocol interpreter</b>	\$960
<b>HP 18225A DECnet network performance analysis</b>	\$960
<b>HP 18226A ISO protocol interpreter</b>	\$960
<b>HP 18227A NetWare protocol interpreter</b>	\$960
<b>HP 18228A NFS protocol interpreter</b>	\$960

# DATA COMMUNICATIONS TEST EQUIPMENT

## LAN Protocol Analyzers and Distributed Monitoring Systems

HP 4990S

565

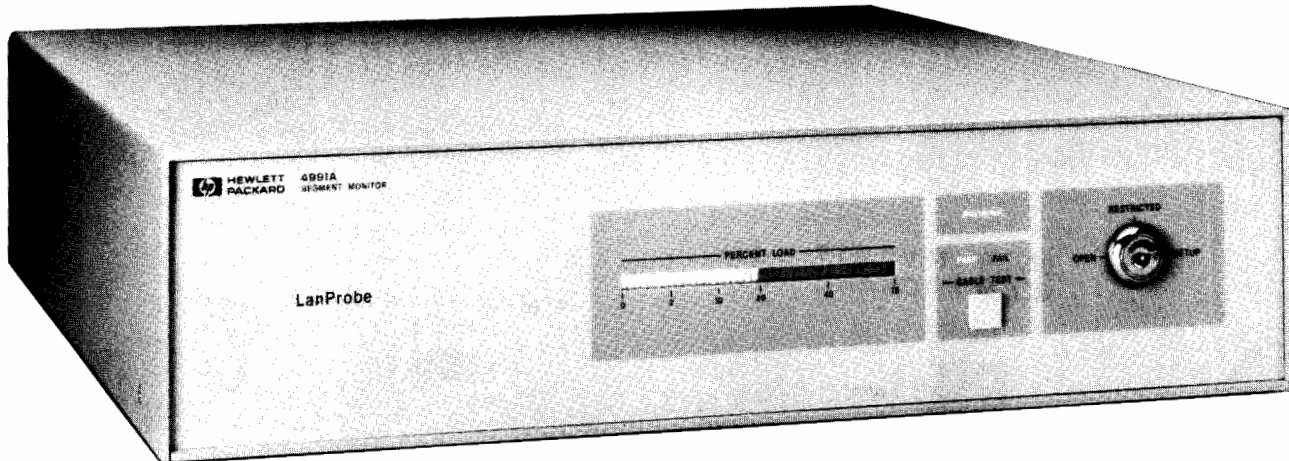

HP 4991A

### Dispatched vs Distributed Monitoring

Different Methods to Meet Different Needs

Troubleshooting/ development needs	Maintenance/ Installation needs	Trend analysis/ LAN management needs
Hardware testing Protocol development Conformance testing Interoperability testing Performance testing Reliability testing	Initial planning Cabling Device installation System testing Certification Configuration testing	Document network Monitor usage Plan future growth Unattended monitoring Remote monitoring Preventive maintenance

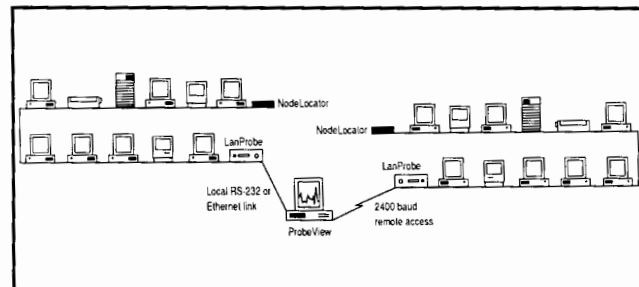

#### HP 4972A Protocol Analyzer

Dispatched  
Attended  
As Needed

#### HP 4990S LanProbe Distributed Analysis System

Distributed  
Unattended  
Immediate

The network manager chooses the right instrument for the job. Although the features of a protocol analyzer and a distributed management system often overlap, each tool has specific benefits for different applications.

A protocol analyzer, such as the HP 4972A LAN protocol analyzer, is ideal for on-site troubleshooting of network faults during development, installation, and maintenance of network hardware and software. A protocol analyzer provides specific, detailed information about network operations. (See page 564 for more information about the HP 4972A protocol analyzer.)

A distributed monitoring system like the HP 4990S LanProbe distributed analysis system is designed into the network layout. An instrumented network provides continuous, preventive network management information unattended by an operator. This system will give the network manager immediate, up-to-the-minute information about the state of the network. A distributed monitoring system such as LanProbe complements the dispatched HP 4972A protocol analyzer.

#### HP LanProbe™ Distributed Analysis System

The HP LanProbe distributed analysis system enables a network manager to monitor all critical aspects of a remote or local Ethernet LAN. Completely independent of network equipment or protocols, the LanProbe system monitors, tests, and diagnoses virtually every aspect of the network and presents the findings in clear color graphics. As an integral part of the network, the LanProbe system provides a comprehensive and informative view that is key to confident network management.

The system consists of one or more LanProbe segment monitors and ProbeView™ software running under Microsoft® Windows.

#### The network is managed locally or remotely

The LanProbe segment monitor attaches to the end of an Ethernet segment and monitors all traffic. Attachment can be direct to a thin or thick coax cable, or via an external transceiver to fiber optic or twisted pair cabling. Network data relating to the segment is transferred to a workstation running ProbeView via RS-232, an Ethernet adapter, or a modem connection.

ProbeView software, which runs on a PC/AT-class workstation, presents network information in graphical displays.

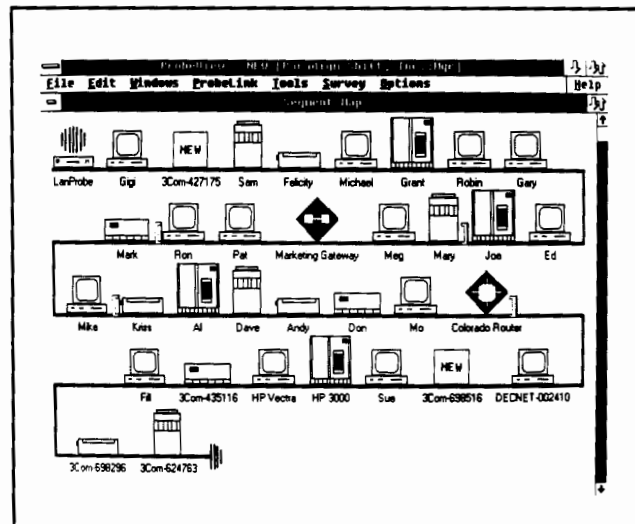

The segment map drawn by ProbeView identifies and displays devices that are active on the monitored segment.

# DATA COMMUNICATIONS TEST EQUIPMENT

## LAN Protocol Analyzers and Distributed Monitoring Systems

HP4990S

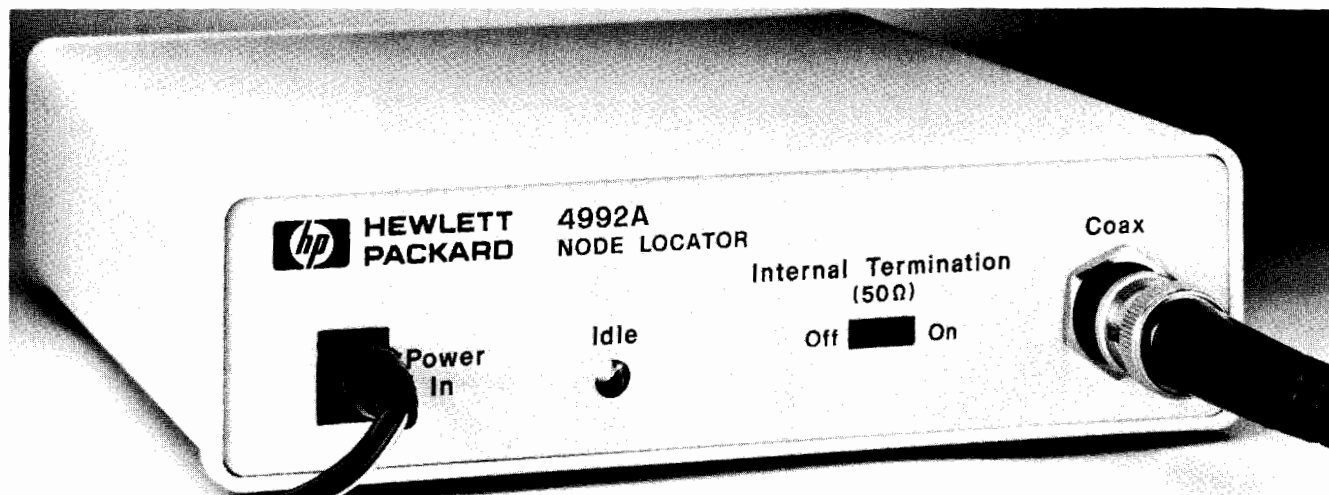

HP 4992A

The HP 4992A NodeLocator option attaches to the opposite end of the cable from the HP 4991A LanProbe segment monitor. It automatically locates the position of nodes on Ethernet networks using coaxial cabling schemes.

Installed in minutes, LanProbe quickly and automatically identifies all active nodes on a segment and displays them, with their adapter card vendor name and Ethernet address, on a map. You can enter additional information about the nodes, such as equipment types and physical location, into the database by clicking on an icon and typing it in.

When the NodeLocator option is used, data on the actual location of the nodes is automatically entered, and the map becomes an accurate representation of the physical layout of the segment. Thereafter, when a new node is installed and becomes active, or when a node is moved or becomes inactive, the change is detected and shown on the map in real time. The system also provides the network manager with precise cable fault information. When a fault is detected the manager workstation is alerted and the precise location of the fault is specified on the map.

The system's interactive capabilities ensure easy LAN management. The LanProbe system continuously monitors vital parameters of the LAN segment. Traffic statistics are gathered and displayed and can be exported in (comma delimited) CSV format for further analysis. In addition, a library of predefined filters and network tests run concurrently, collecting valuable diagnostic information.

The LanProbe system provides an unmatched tool for documenting and monitoring your network.

### Features

- Network and segment maps identify nodes, addresses, and position.
- Real-time update of the maps via NodeLocator.
- Cable test option detects and reports breaks, shorts, and faulty termination.
- Statistics chart LAN utilization and performance in real time and over a period of time.
- Traces all packets or specific packets.
- Alerts based on user-definable thresholds and entry into a log.
- Remote access with built-in 2400 baud modem.
- Continuous monitoring of the LAN.
- Concurrent and interactive operation of all tools.

### Specifications

#### HP 4991A LanProbe segment monitor

**Network Compatibility:** Ethernet version 2.0, IEEE 802.3

**Size:** 10.5 H x 41.4 W x 44.5cm D (4.15" x 16.3" x 17.5")

**Weight:** 7.26kg (16 lb)

#### HP 4992A NodeLocator

**Network Compatibility:** Ethernet version 2.0, IEEE 802.3

**Size:** 41.7 H x 14.15 W x 18.29cm D (1.64" x 5.57" x 7.20")

**Weight:** .55kg (1.2 lb)

#### HP 4993A ProbeView Console

Includes: Vectra QS/20 model 46 PC, 42 Mbyte half-height hard disk drive with embedded controller, 2 Mbyte memory, 5.25 floppy drive, VGA monitor and multistandard I/F card, ThinLan network access card, HP-HIL mouse, MS-DOS® USA, Microsoft® Windows USA, HP 4990A ProbeView™ Manager software.

### Ordering Information

	Price
HP 4990S LanProbe distributed analysis system	
HP 4991A LanProbe segment monitor	\$4,995
Opt 001 LanProbe, deletes cable test, BNC connector and NodeLocator capability	-\$300
Opt 002 LanProbe, deletes internal modem	-\$225
Opt 003 LanProbe, deletes cable test, BNC connector, internal modem and NodeLocator capability	-\$525
HP 4992A NodeLocator	\$975
HP 4993A ProbeView console	\$12,750
Opt 001 Adds 3.5" floppy drive	+\$265
Opt 002 Deletes ThinLan card adds StarLan 10 card	-\$220
Opt 003 Adds an additional 2MB memory	+\$1,506
Localization option must be selected. Please contact your local HP Sales office for information.	
HP 4990A ProbeView manager software	\$5,000
Opt 100 Adds ProbeView observer software with ProbeView manager software	+\$250
HP 18490A ProbeView observer software	\$250

Microsoft is a U.S. registered trademark of Microsoft Corporation  
MS-DOS is a U.S. registered trademark of Microsoft Corporation.

# DATA COMMUNICATIONS TEST EQUIPMENT

Signaling Test Sets

HP 37900C, 37900B

567

- Multi-link testers for common-channel Signaling System No.7
- Call tracing
- Text decoding of level 3 and 4 data (optional user-defined decoding)
- Programmable No.7 device emulation

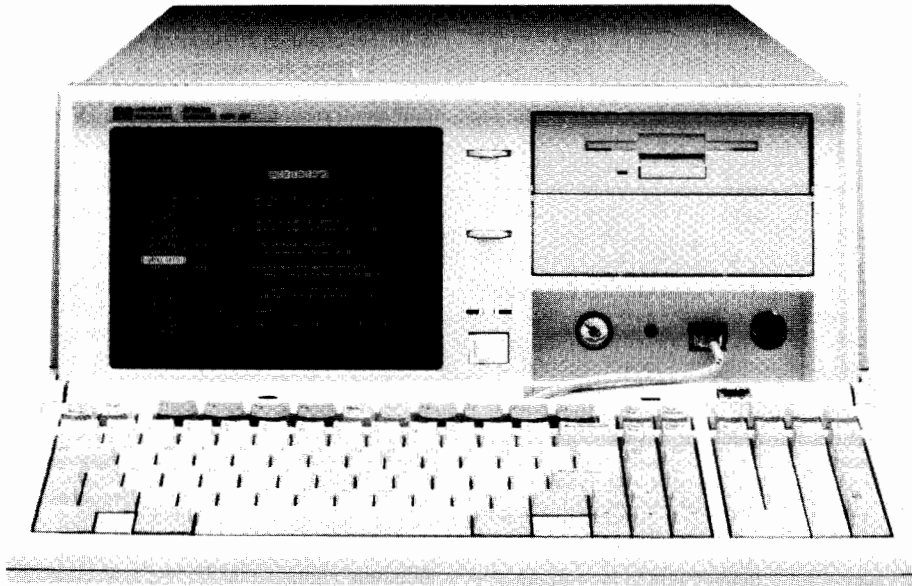

HP 37900C

## HP 37900B/C Signaling Test Sets

The HP 37900C signaling test set is a high-performance solution for testing the demanding No.7 common-channel signaling protocol (Signaling System No.7). The HP 37900C is capable of monitoring two or emulating four bi-directional No.7 signaling links.

The HP 37900B is a modular No. 7 test set consisting of a workstation, signaling link processors, and dedicated software. The capabilities are similar to the HP 37900C, but the HP 37900B can monitor four and emulate eight bi-directional links simultaneously.

### Features

The major features of this test set include non-intrusive monitoring and recording of signaling messages on signaling links; optional interfaces for datacom and telecom applications; real-time and post-analysis of No.7 data; text decoding of level 3 & 4 data (CCITT RED/BLUE books and, optionally, national variants such as ANSI/BELLCORE SS7, BTNR 167, and applications such as GSM, CLASS and ABS); emulation of No.7 devices for feature testing.

### Assessing No.7 Performance

The HP 37900B/C simplifies the manufacture, qualification or maintenance of No.7 equipment or software.

The non-intrusive monitoring capabilities of the HP 37900B/C allow troubleshooting and assessing the performance of No.7 signaling links. For example, real-time analysis of signaling activity, through dynamic display of loading levels and error rates, allows problems to be quickly assessed. Sophisticated data triggers and filters can readily be created to control the logging of data so that only useful data is recorded. In addition, the call trace facilities can obtain the No.7 messages related to a specific call.

Interpretation of logged signaling messages is straightforward; the data can be automatically decoded directly to text. (Optional software is available for customized text decodes.) Powerful search,

selective view, and display facilities aid the examination of logged data, simplify investigations, and minimize troubleshooting.

A simple programming language - optimized to send, receive, and validate message signal units (MSUs) - speeds the creation of conformance, acceptance or regression emulation tests.

Users define messages in a catalog of messages that is separate from the test script. Messages captured while monitoring can also be transferred to the catalog and edited as required. To simplify testing further, the HP 37900 automatically handles level 2 operations (including signaling link alignment) and, optionally, level 3 operations sufficient to keep the link in service. During a test, the HP 37900B/C generates or responds to signaling messages on the No.7 links, and allows users to follow the progress of the test while it is running. On completion, users obtain a report of the signaling interactions for fault tracing or test performance documentation.

### Specifications

**RAM buffer for logging:** 2.5 Mbyte (expandable to 6.5 Mbyte)

**Built-in disc:** 20 Mbyte 37900C; 40 Mbyte 37900B

#### Monitor

**Capture performance:** 100% MSUs per link (each direction)

**Timestamps for logged data:** 1 millisecond accuracy

**No.7 specific triggers and filters:** Include triggering on level 2, 3 or 4 data, and erroneous SUs; and filtering out of FISUs, LSSUs or specified MSUs

#### Emulate

**Message generation performance:** 100% MSUs

**Messages per catalog:** 300

**Save/retrieve catalogs from disc:** Yes

### Ordering Information

Please contact your local Hewlett-Packard Sales & Support Office. See page 737.

# DATA COMMUNICATIONS TEST EQUIPMENT

## Twisted-pair LAN Cabling

### General Information

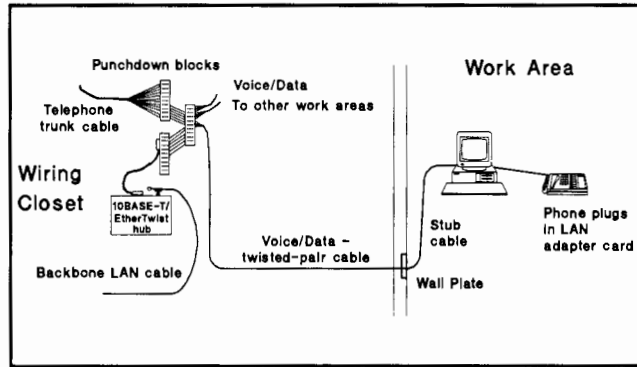

### Twisted pair cable installation

#### Twisted-pair for LANs

Twisted-pair phone cable is emerging as the most popular Ethernet LAN media. This new use of twisted-pair cable for data communications is driven by its many benefits: low cost, may already be installed, single media for both voice and data communications, support of a structured wiring system, as well as simple installation and administration. These benefits, combined with the finalization of the IEEE 802.3 10BASE-T standard, establish twisted-pair as the preferred alternative to networking with coaxial cable.

However all twisted-pair cable is not suitable for support of 10-Mbit/s data traffic. Developed and installed for voice use only, some twisted-pair cable is of poor quality, may be installed improperly, or may exist in a noisy environment. Because all of these factors affect signal quality and transmission, cabling should be evaluated prior to supporting a 10BASE-T network. The 10BASE-T standard has defined parameters for twisted-pair cable in the areas of signal attenuation, burst noise, impedance and crosstalk attenuation.

#### Testing Twisted-pair LAN Cable

For optimum network utilization, twisted-pair cable should be tested when it is newly installed, when it is part of an existing cabling system and as part of a troubleshooting procedure when isolating faults in a network. And because installation procedures (e.g. number of crossconnects in cable path) affect signal quality, cable should be tested after installation.

#### IEEE 802.3 10BASE-T Standard

The IEEE 802.3 10BASE-T standard defines transmission of Ethernet/802.3 data over twisted-pair cable. Following are the key parameters specified:

##### Crosstalk attenuation

Crosstalk in twisted-pair cable is caused by electrical interference from adjacent twisted-pairs. Crosstalk attenuation can be measured two ways: near-end crosstalk attenuation (pair-to-pair) and multiple disturber crosstalk attenuation (bundled). Near-end crosstalk is measured between one transmit pair and one receive pair within a cable. Multiple disturber crosstalk is measured between one receive pair and multiple transmit pairs in bundled (25-pair) cables.

##### Attenuation

Attenuation is a measure of how much the signal amplitude decreases during transmission from one point to another. Cable quality, untwisted cable, too many cross-connect blocks, cable length, and temperature of cable's path can all affect the cable's attenuation.

##### Burst noise

Burst noise is electrical noise picked up by the cabling from an outside source (e.g. electrical equipment). If this noise is sufficiently powerful, data traffic will be corrupted.

#### IEEE 802.3 10BASE-T Specifications

	Frequency	Specification	
Attenuation*	5 MHz	≤ 11.5 dB	
	10 MHz	≤ 11.5 dB	
Crosstalk attenuation	Near-end (4-pair)	5 MHz	≥ 30.5 dB
		10 MHz	≥ 26 dB
	Multiple Disturber (25-pair)	5 MHz	≥ 27.5 dB
		10 MHz	≥ 23.0 dB
Burst noise	—	≤ 264 mV	

\* For twisted-pair cable that is not installed, the specification is 10 dB. This allows 1.5 dB attenuation for various connectors used when the cable is installed.

In addition to testing for IEEE 802.3 10 Base-T specifications the HP 28687A Wire Test Instrument, also tests for opens, shorts or miswiring of data pair-wires.

**For information** on HP's solution for testing twisted-pair LAN cabling, see the following page on the HP 28687A wire test instrument. For information on HP's complete family of 10BASE-T products pictured below, (HP EtherTwist) contact your local HP sales office, (see page 737) or HP LAN dealer.

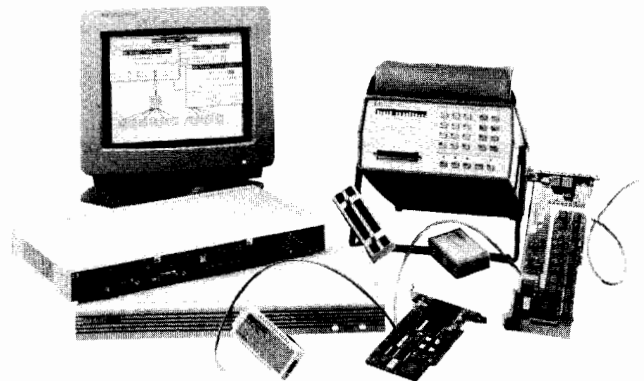



# DATA COMMUNICATIONS TEST EQUIPMENT

Wire Test Instrument

HP 28687A

569

- Troubleshooting and verification of type 10base-T cable
- Easy to use



HP 28687A

## HP 28687A Wire Test Instrument

The portable HP 28687A wire test instrument verifies and troubleshoots twisted-pair LAN cabling for Type 10BASE-T networks. It lets the user quickly and easily perform the necessary tests to evaluate the key parameters specified by the IEEE 802.3 10BASE-T standard.

### Complete Testing of Type 10BASE-T Cable

Twisted-pair LAN cable, unlike coaxial cable, allows for variations in physical characteristics and has dynamic performance requirements such as crosstalk, signal attenuation, and installation-dependent specifications. Tools developed for the telephone industry are not specialized to test for these specification requirements. The HP 28687A wire test instrument can quickly identify problems in these areas. Designed specifically to test for compliance to the IEEE 802.3 10BASE-T standard, the HP 28687A lets you easily verify and troubleshoot twisted-pair LAN cabling.

### Easy to Use

This lightweight, portable unit saves time by simplifying the complex task of testing twisted-pair cabling. Individual tests or combinations of tests can be run, and up to 24 pairs (twelve 10BASE-T connections) can be tested simultaneously. The alphanumeric display steps you through the test procedures and gives you complete diagnostic information when you want it. An RS-232 printer port also allows you to quickly get a copy of the results. Twelve green LEDs indicate whether the pairs have passed or failed the test(s). Intermittent cabling problems can be identified by pushing the MONITOR button, which performs the selected tests and compiles statistical parameters for up to 24 hours.

### Troubleshooting

Network downtime is expensive. While the costs of a downed network cannot always be quantified, daily business depends on a functional network. With the HP 28687A, cable problems can be easily and quickly identified.

### Verification

To avoid intermittent problems and performance degradation, both new and in-place twisted-pair cabling should be evaluated prior to usage as a LAN medium. The HP 28687A wire test instrument verifies the suitability of in-place twisted-pair cable for your 10BASE-T network prior to usage as a local area network cabling system.

## HP 28687A Features

- The HP 28687A wire test instrument tests key parameters for Type 10BASE-T networks: crosstalk attenuation, signal attenuation over frequency, burst noise, and continuity. (Crosstalk attenuation and signal attenuation are measured using 5-MHz sine waves, 10-MHz sine waves and 10-Mbit/s pseudo-random Manchester-encoded data.)
- For added flexibility, the HP 28687A evaluates both bundled 25-pair and individual 4-pair twisted-pair cabling.
- Weighing less than 10 pounds, this unit is easily portable to any wiring closet or cable run.
- A built-in RS-232 printer port makes it easy to get hard-copy results at any time.
- Monitor function allows user-selected tests to be performed over a 24-hour period.
- To ensure reliability, the HP 28687A runs a self-test at power-on and recalibrates periodically during use.
- Easy-to-read LEDs indicate which ports have been selected for testing, which tests have been selected, and which ports have passed or failed.
- To make wiring connections quickly, the HP wire test instrument includes a built-in 50-pin Telco connector as well as a 12-port modular adapter for 8-pin jacks.

## Physical Specifications

**Size:** 27.9 H x 34.3 W x 15.9 cm D (11.0" x 13.5" x 6.3")

**Weight:** 4.1 kg (9.0 lb)

## Measurement Specifications

	Measurement Range	Accuracy	Resolution
<b>Signal attenuation</b>	0-15 dB	± 0.5 dB	0.1 dB
<b>Crosstalk attenuation</b>	0-36 dB	± 1.0 dB	0.1 dB

**Burst noise:** 232 mV minimum ± 32 mV

Measurement made through a 3-pole Butterworth low-pass filter with a 3-dB cut off at 15 MHz.

### Source characteristics

**Frequency range:** 5-MHz sine wave, 10-MHz sine wave, 10-Mbit/s pseudo-random Manchester-encoded data

**Output level range:** 1.25 volts peak ± 250 mV

**Impedance:** 100 ohms ± 10 ohms

**Output connector:** 50-pin Telco connector

### Receiver characteristics

**Frequency range:** 5 MHz to 15 MHz

**Input level range:** 20 mV peak to 1.5 V peak

**Impedance:** 100 ohms ± 10 ohms

**Input connector:** 50-pin Teleco connector

## Ordering Information

HP 28687A wire test instrument

## Price

\$6,500



# DATA COMMUNICATIONS TEST EQUIPMENT

## Transmission Impairment Measuring Sets

HP 4945A, 4947A, 4948A

571

- Complete analog testing to North American standards for: voice-grade data circuits, program circuits, metallic digital circuits

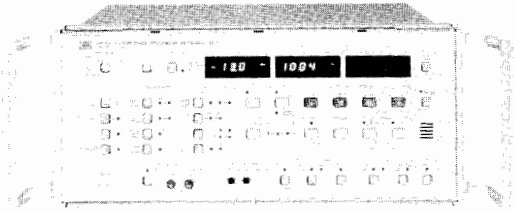

HP 4947A

### HP 4947A and HP 4945A TIMS

The HP 4947A (5 kHz) and HP 4945A (110 kHz) Transmission Impairment Measuring Sets (TIMS) provide a complete set of IEEE-754-compatible measurements, for installation, maintenance, and troubleshooting, as well as manufacturing. Both instruments feature automatic end-to-end testing and comprehensive remote control/printer output functions.

#### Measurement Capability

Measurement	HP 4945A	HP 4947A
Level/frequency	to 110 kHz	to 5 kHz
Attenuation distortion	yes	yes
Intermodulation distortion*	yes	yes
Envelope delay distortion	yes	yes
Gain slope	yes	yes
Signal-to-noise & notched noise	yes	yes
Message circuit noise & noise-to-ground	yes	yes
Noise filters:		
C-message & 3 kHz	yes	yes
15 kHz, program, 50 kbit	yes	no
P/AR	yes	yes
2/4-wire return loss:		
ERL, SRL Hi, SRL Lo	yes	yes
Sinewave	yes	no
Equal level echo path loss	no	yes
Phase jitter	yes	yes
Amplitude jitter	yes	no
Gain hits, phase hits, dropouts	yes	yes
3-level impulse noise	yes	yes
Impedance (ohms)	135/600/900/1200	600/900/1200

\* The intermodulation distortion technique is licensed under Hekimian Laboratories, Inc., US Patent No. 3862380.

#### Ordering Information

HP 4945A TIMS	\$18,000
Opt 001 100/200V operation	\$0
Opt 101 Adds HP 18162A HP-IB module	+\$555
Opt 102 Adds HP 18163A RS-232-C module	+\$555
Opt 104 Adds HP 18169A 19-in rackmount kit	+\$82
Opt 105 Adds HP 18170A soft vinyl case	+\$227
HP 4947A TIMS	\$11,800
Opt 908 19-in rackmount kit	+\$41
<b>Accessories for HP 4945A and HP 4947A</b>	
HP 18182A 1.5m cable with WECO 310 and alligator clips.	\$67
HP 15513A 1m cable with WECO 310 on each end.	\$62

- Voice-grade data circuit testing - without disturbing traffic
- True preventive maintenance
- Network management information - without special modems
- Suitable for North American and CCITT environments

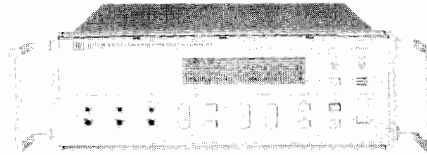

HP 4948A

### HP 4948A In-service TIMS

The HP 4948A is a unique transmission impairment measuring set (TIMS) that lets you test data circuits, carrying voice-grade modem traffic, while the circuits are still in service. This opens up new cost-saving test strategies for managing data circuits.

With the HP 4948A you can implement a preventive maintenance policy and routinely check lines against a benchmark, while the circuits are still operating. Testing can be done at convenient times, even when the circuits are under most stress.

All HP 4948A capabilities can be remotely controlled and can be used to build a network monitoring system. The HP 4948A is an economical means of producing accurate data for private network management, even for small networks, using a variety of modem types.

#### Measurement Capability

The HP 4948A measures: level, frequency, S/N, phase jitter, amplitude jitter, dropouts, gain hits, phase hits, impulse noise; and, on modem signals only, attenuation distortion and delay distortion.

#### Compatible Modems

Data Rate	Compatible Modem Types (4-Wire) - Examples
14400 b/s (optional)	CCITT V.33 (trellis coded) V.33 with 1700 Hz carrier
9600 b/s	CCITT V.29, AT&T 209, AT&T 2096 V.29 with 1800 Hz carrier 4x4 QAM with 1700 Hz carrier
4800 b/s	CCITT V.27, AT&T 208, AT&T 2048
2400 b/s	CCITT V.26 A&B, AT&T 201 B&C

AT&T is a trademark of the American Telephone and Telegraph Company.

#### Connector Types

	Transmit & Receive Connectors	
	WECO 310 & Bantam	Siemens 3-pin
Stand-alone front connectors adjustable legs	HP 4948A Standard	HP 4948A Option 003
For rack mounting front connectors flat base	HP 4948A Option 001	HP 4948A Option 004
For rack mounting rear connectors flat base	HP 4948A Option 002	HP 4948A Option 005

#### Ordering Information

HP 4948A In-service TIMS	\$13,690
Opt 001, 002, 004, 005: See Table above	-\$500
Opt 006 14.4 kbit/s V.33 capability.	+\$1,010
Opt 908 19-in rackmount kit	+\$35

# DATA COMMUNICATIONS TEST EQUIPMENT

## Transmission Impairment Measuring Sets (TIMS)

HP 4934A, 4935A, 4936A, 3551A, 3552A

- Rugged, portable, affordable
- Optional battery operation with built-in recharger

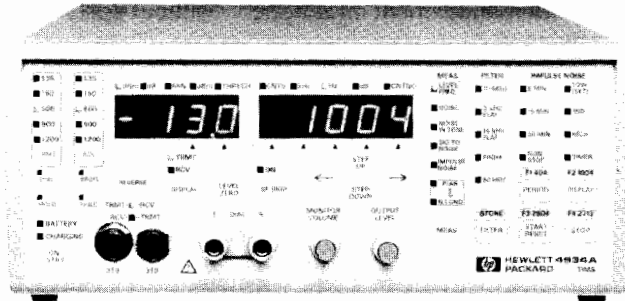

HP 4934A

### Transmission Impairment Measuring Set (TIMS)

The HP 4934A transmission impairment measuring set (TIMS) increases installation and maintenance productivity for telephone companies and service providers through its ease of use, portability and ruggedness. HP 4934A measurements (using IEEE 743-1984 methods) include the following:

- Level/frequency up to 110 kHz
- Noise and noise-to-ground
- Noise-with-tone and signal-to-noise ratio
- 3-level impulse noise
- P/AR

The HP 4934A is easy to use. You can cut out errors with simple keystrokes and one-button-per-function operations. The dedicated keys and indicators allow you to see the measurement setup at a glance. Results are easy to read on large, bright displays. There is a built-in operating summary. The manual describes how to do measurements and also describes the principles of each measurement and how to interpret the results.

The HP 4934A is easily carried by hand and stowed in an aircraft cabin. The front cover stores the power cord and the two standard test cords, or they can be stored in an optional soft vinyl carrying case for greater protection and more accessory storage.

### Applications

The HP 4934A is ideal for telephone companies and for service providers for the installation and maintenance of special services using a wide range of analog circuit types. The HP 4934A provides the tests required to qualify the local loop for Digital Data System (DDS) up to 56 kbit/s and basic rate ISDN.

The features and low cost make the HP 4934A suitable for data communications users who need to check line performance against tariffs. If there is a fault, the users can quickly determine who is responsible for fixing it. Because the measurement results of the HP 4934A are reliable, they are readily accepted by circuit or equipment vendors and repairs can be made quickly to minimize downtime.

### Ordering Information

	Price
HP 4934A TIMS-Including front-panel cover, power cord, 2 HP 15513A test cords (with WECO 310 jack plugs), manual	\$2,790
Opt 001 Battery pack with built-in charger	+ \$300
Opt 010 Delete test cords	- \$100
Opt J01 Replaces North American features and connectors with CCITT (specification similar to HP 4936A). Deletes test cords. 820Hz hold tone.	+\$700
Opt J02 As J01, except 1020 Hz hold tone.	+\$700

### Accessories

HP 15513A 1m cable, WECO 310 jack plug each end	\$62
HP 15677A Ladder bracket	\$36
HP 15678A 19-inch rackmount	\$190
HP 18134A Vinyl carrying case	\$144
HP 18182A 1.5m cable, WECO 310 jack plug to alligator clips.	\$67

### HP 4935A/4936A TIMS

The HP 4935A/4936A Transmission Impairment Measuring Sets are rugged, portable test sets that provide the basic analog tests to isolate faults and to qualify circuits for voice, data, and broadcast service. The HP 4935A performs measurements compatible with the Bell standards (BSTR 41009) and IEEE standards (IEEE 743-1984). The HP 4936A is compatible with CCITT recommendations. The HP 4935S data transmission test system consists of HP 4935A plus the HP 4925B bit error rate test set (see page 573).

### Specifications

**Measurements:** Level, frequency, circuit noise, noise-with-tone, signal-to-noise ratio, 3-level impulse noise (quiet) (HP 4936A), 3-level impulse noise (quiet or tone) (HP 4935A), noise-to-ground (HP 4935A), P/AR (HP 4935A option).

### Filters:

#### HP 4935A

C-message  
3 kHz flat  
Program  
15 kHz flat  
50 kbit  
1010 Hz notch

#### HP 4936A

Psophometric (P.53)  
275-3250 Hz flat (O.71 impulse noise)  
Sound unweighted (J.16)  
Sound weighted (J.16)  
820 Hz notch (1020 Hz optional)

**Size:** 127 H x 279 W x 381 mm D (5.0" x 11.0" x 15.0")

**Weight:** 5.0 kg (11 lb); 6.5 kg (14 lb) with battery

### Ordering Information

	Price
HP 4935A TIMS (North American)	\$3,830
Opt 001 Rechargeable batteries	+ \$380
Opt 002 Add P/AR measurement, delete noise-to-ground	+ \$155
Opt 003 Add options 001 and 002	+ \$465
HP 4936A TIMS (CCITT)	\$4,880
Opt 001 Include 820 Hz tone, add rechargeable batteries	+ \$535
Opt 002 1020 Hz tone replaces 820 Hz	\$0
Opt 003 Add options 001 and 002	+ \$535
HP 4935S Data Transmission Test System	\$5,405
Opt 001 Rechargeable batteries	+ \$385
Opt 002 P/AR, no noise-to-ground on HP 4935A	+ \$155
Opt 003 Add options 001 and 002	+ \$465
Opt 101 RS-232-C/V.24 on HP 4925B	+ \$420
Opt 102 V.35 interface and 115V power module (HP 18185A) on HP 4925B	+ \$620
Opt 104 V.35 interface and 220V power module (HP 18194A) on HP 4925B	+ \$660

### HP 3551A/3552A Transmission Test Sets

The HP 3551A (North American) and HP 3552A (CCITT) are basic level/noise measuring sets to 60 kHz. Both test sets include selectable noise filters, holding circuits and built-in rechargeable batteries with charger.

### Ordering Information

	Price
HP 3551A Transmission Test Set (North American)	\$5,400
HP 3552A Transmission Test Set (CCITT)	\$6,340

# DATA COMMUNICATIONS TEST EQUIPMENT

Datacom Test Sets

HP 37711A, 4925B

573

- Combined T1 & datacom testing up to 1.5 Mbit/s  
- no need for separate testers or plug-ins
- Four interfaces in a single tester
- Powerful results storage & analysis  
without using a printer
- Rugged, portable & easy-to-use

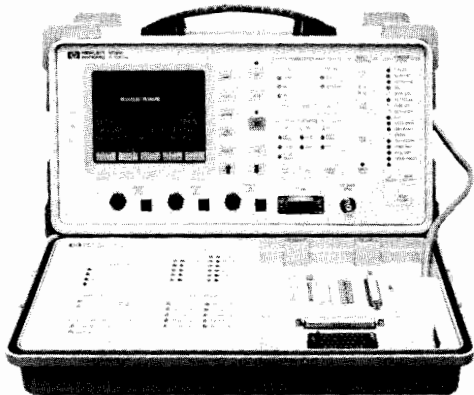

HP 37711A



## HP 37711A T1/Datacom Test Set

The HP 37711A tests at T1 (DSX and line), RS-232, RS-449 (balanced) and V.35 interfaces. The instrument consists of the HP 37701A T1 Tester (see page 550) plus the HP 15901A Datacom Module (available separately for existing HP 37701A users). In addition to a full range of BER tests, the HP 37711A performs timing analysis on interface control leads - with transition diagrams on the screen - and it has results storage and histogram alarm/results presentation on the screen.

### Applications

- T1 and datacom installation
- Long-term network monitoring
- Troubleshooting and service restoration

### Specifications

T1, remote control, power supply and size specifications as HP 37701A (see page 550).

**Weight:** 6kg (13lb).

**Datacom interfaces:** RS-232, RS-449, V.35, DTE or DCE

**Data rates:** 600 bit/s to 1.544 Mbit/s (synchronous, built-in synthesizer); 50 bit/s to 19.2 kbit/s (asynchronous)

**RS-232 breakout:** patch points, monitors, voltage sources & switches

**RS-449/V.35:** activity indicators on data, clock & control circuits

**Test patterns:** 63, 511, 2047, 2<sup>15</sup>-1 PRBS, QRSS, (all invertible); all 1s, 1010 ..., 24-bit word, FOX message

**Measurements:** errors, BER, blocks, block errors, block error ratio, error seconds, % EFS, clock slips, alarms, Tx & Rx frequency, G821 analysis

Control circuit timing analysis measures time between selectable start/stop events.

**Range:** 1s, resolution 0.1 ms

**Transition diagrams:** for MON, RTS, CTS, DTR, DSR & DCD

## HP 4925B Bit Error Rate Test Set

The HP 4925B bit error rate test set provides the standard bit and block error tests and also measures errored seconds, percent-error-free seconds, timing delay, and parity errors over both RS-232/V.24 and V.35. Complete data testing is available from the HP 4925B from 75 bit/s to 19.2 kbit/s for asynchronous framed or unframed systems. In synchronous systems data rates up to 72 kbit/s are available, which makes the HP 4925B ideally suited for DDS testing at all rates.

Increased flexibility is afforded by a complete breakout box. You can manipulate and monitor individual signal lines on the RS-232/V.24 interface or crosspatch any line from the DCE side of the interface to the DTE side. The HP 4925B also transmits the FOX message using a 5-bit baudot, 6-bit EBCD, 7-bit ASCII, or 8-bit EBCDIC code to terminals and printers. It includes detection and annunciation of dropouts, clock slips, and RTS-CTS delay time. Three separate start-up tests, end-to-end, loopback, and BELL 208B modem, enable dynamic testing of modems, which makes the HP 4925B extremely useful in isolating faults related to automatic equalization.

The HP 4925B is powered by six 9-volt alkaline transistor batteries, allowing greater than 50 hours of RS-232/V.24 operation. An ac module (HP 18185A or HP 18194A) is recommended for use with V.35 interfaces.

### Ordering Information

HP 37711A T1/Datacom Tester \$7,500

Opt 001 T1 pulse shape and wander/clock slips measurement + \$550

### Accessories (HP 37711A)

For HP 37701A accessories, see page 550.

HP 92204S RS-232 cable \$50

HP 15692A RS-449 cable \$68

HP 15708A V.35 cable \$250

HP 4925B Bit Error Rate Test Set \$1,450

(does not include interfaces)

Opt 001 Carrying case + \$118

Opt 101 RS-232/V.24 (HP 18183A) + \$420

Opt 102 V.35 (HP 18184A) and 115V power module (HP 18185A) + \$620

Opt 104 V.35 (HP 18184A) and 220V power module (HP 18194A) + \$660

### Accessories (HP 4925B)

HP 18183A: RS-232/V.24 interface \$420

HP 18184A: V.35 interface \$495

HP 18185A: 115V power module \$124

HP 18191A: 19-in rackmount kit \$196

HP 18194A: 220V power module \$165

# HEWLETT-PACKARD INTERFACE BUS

## Versatile Interconnect System for Instruments and Controllers

### General Information

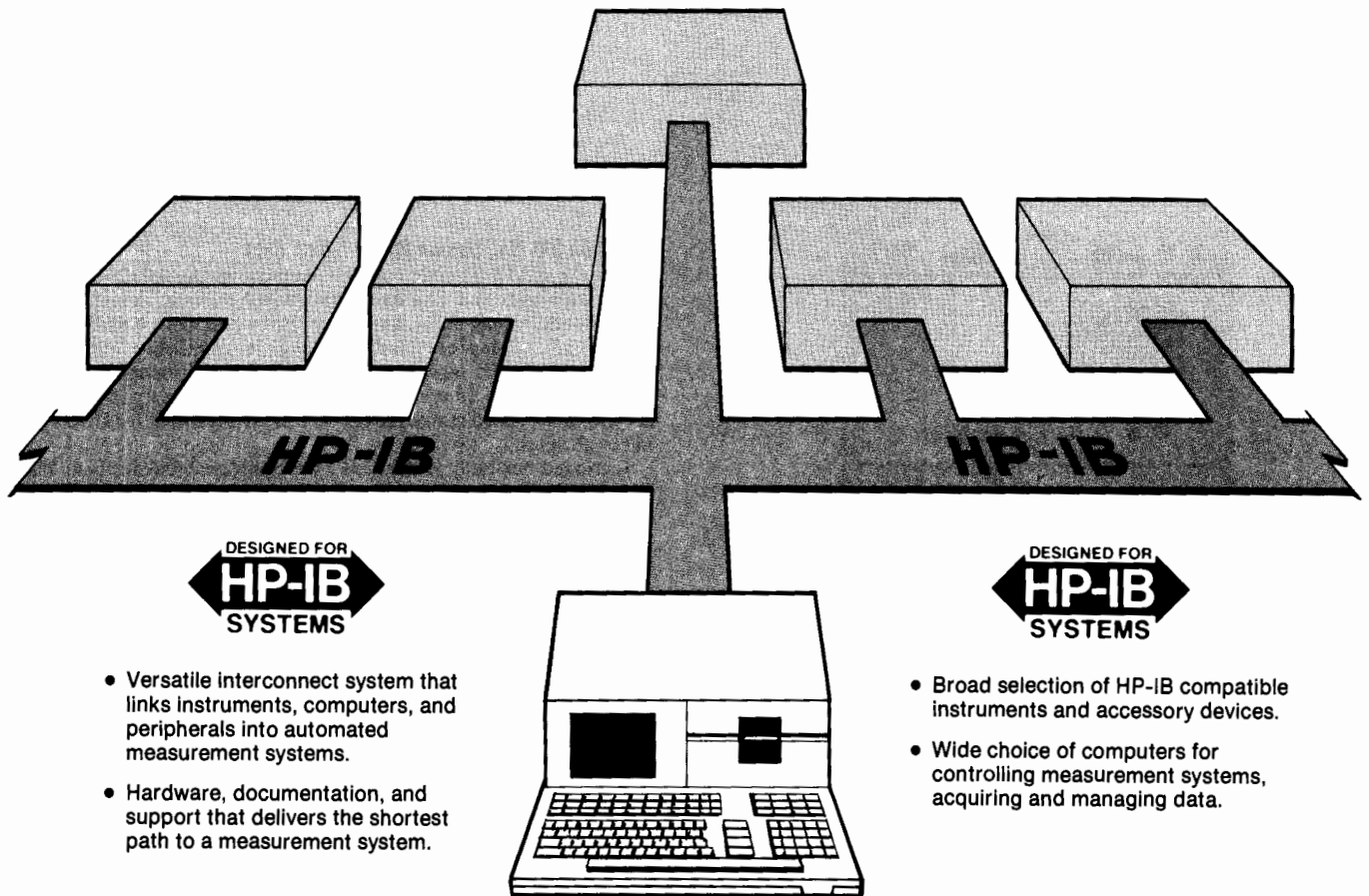

- Versatile interconnect system that links instruments, computers, and peripherals into automated measurement systems.
- Hardware, documentation, and support that delivers the shortest path to a measurement system.

- Broad selection of HP-IB compatible instruments and accessory devices.
- Wide choice of computers for controlling measurement systems, acquiring and managing data.

### Advantages of HP-IB Systems

There are many applications where the measurement power of interactive instruments can be further enhanced by desktop computers or minicomputers. Operating in a remote mode can provide more exact, error-corrected results than conventional manual operation techniques.

The following three major parameters combine to reduce significantly the engineering development costs of configuring measurement systems:

1. The Hewlett-Packard Interface Bus, also known as HP-IB
2. Distributed computing through the growing number of "smart" instruments with internal microprocessors
3. The broad choice of computers ranging from friendly, easy-to-program desktop computers to more sophisticated computer systems capable of managing multistation instrument clusters and complex data bases.

### Relationship Between HP-IB and Other Interface Standards

Hewlett-Packard is committed to the overall advancement of measurement technology and has for some time been working to simplify and standardize instrumentation interfacing. An example of such an effort is the involvement with the HP-IB from its inception at Hewlett-Packard to its present status as a world instrumentation interface standard (IEEE 488-1978 and IEC 625-1).

In mid-1972, Hewlett-Packard began to participate in various international standardization bodies. The U.S. Advisory Committee, composed of diverse interests represented by both users and manufacturers, first established initial goals, then adopted the interface concept used by the HP Interface Bus as an appropriate starting point. A draft document was subsequently written and evaluated by members of the committee, then submitted as the U.S. Proposal to the IEC (International Electrotechnical

Commission) Working Group in the autumn of 1972. Since then, the interface definition has undergone a number of minor changes to accommodate various needs at the international level.

In September 1974, the parent technical committee, IEC TC66, approved the main interface draft document for a formal ballot among the member nations of the IEC. Balloting took place in 1976, and IEC recommendation 625-1 was adopted. The IEC recommendation, using a different connector, is totally compatible with the present definition of the HP-IB.

Meanwhile, the IEEE Standards Board approved IEEE Standard 488-1975 "Digital Interface for Programmable Instrumentation", first published in 1975 and again published in 1978 with minor editorial changes as IEEE Standard 488-1978. The IEEE standard is also fully compatible with the HP-IB. In January 1976, the American National Standards Institute adopted the

IEEE Standard and published it initially as ANSI Standard MC 1.1.

The standardized interface concept is now widely accepted. Hundreds of manufacturers in more than fourteen countries offer thousands of products that use the HP-IB concepts articulated in IEEE-488. As more instrumentation interface standards evolve from the HP-IB, we will clearly indicate the relationship of the Hewlett-Packard Interface Bus to those standards, just as we have done with ANSI/IEEE Standard 488 and IEC Publication 625-1.

### Why the HP Interface Bus Name?

As the list of HP products available with the "new digital interface" grew, our customers sought a convenient way to identify those products having the interface capability. In response, in 1974 we adopted the name "Hewlett-Packard Interface Bus" or simply "HP-IB". We will continue to use the identifying name and this symbol:



Both are used with appropriate HP products to identify their interface capabilities.

The Hewlett-Packard Interface Bus fully complies with IEEE Standard 488. As such, it incorporates the mechanical, electrical, and functional specifications of the standard. A fourth and vital element of any interface system is the operational aspect of a product at both the human-machine interface and the machine-machine interface at the HP-IB port. HP-IB capability provides additional

user benefits that are beyond the scope of IEEE Standard 488. Typical user conveniences include high-level language implementation of interface functions, underscored program codes on instrument front panels for easy programming, convenient data output formats, and designed-in learn modes. In addition, we provide complete support documentation in the form of programming and interfacing guides, application notes and operators' manuals that illustrate the added benefits for users of products with HP-IB capability.

### Single-Source Systems Approach

The decision to use a system instead of conventional manual methods must be based on an engineering evaluation of benefits versus costs. The many benefits associated with a systems approach include the following:

- More consistent results in repeated measurements because a system is not subject to operator fatigue.
- Greater throughput because systems are generally faster.
- More thorough testing because system speed allows more parameters to be measured in a shorter time.
- Results expressed in engineering or scientific units because many systems controllers are capable of on-line data manipulation.
- Greater accuracy because system errors can be measured automatically, stored and accounted for in the results.
- Adaptive data acquisition so that a system can be programmed to branch to other measurements to help pinpoint an abnormal condition.
- Measurement results stored in computer memory or on hard copy.

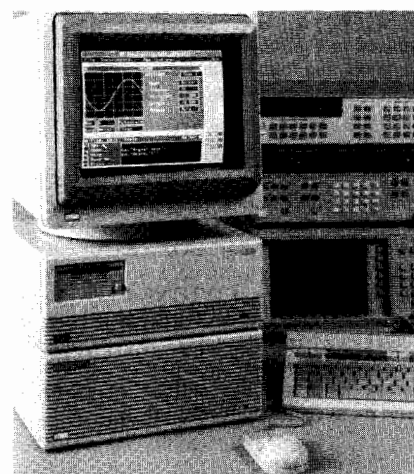

Hewlett-Packard offers a broad range of controllers and software solutions to meet your measurement automation needs. HP E2000A Interactive Test Generator software works with instrument drivers to provide a uniform, user-friendly interface to a wide variety of HP-IB instruments.

It is our objective to make the integration of instrumentation systems easier by providing instruments and computers designed for systems applications. Computers are designed with HP-IB options that allow easy hook-up to the bus and incorporate easy-to-use bus commands in their software. Hewlett-Packard's policy when designing HP-IB compatible instruments is to eliminate interfacing ambiguities associated with controllers and instruments operating per the ANSI/IEEE and IEC standards by adopting guidelines for consistent interface design.

Proper training on system components is very important for efficient use of any interface system. Therefore, we offer training at sales and service offices worldwide on HP desktop computers, computer systems, and instruments as they relate to the HP-IB. In the area of HP-IB support documentation, we offer general interface technical descriptions, operating and service manuals with programming information, instrument/controller introductory operating guides, quick reference guides, and application notes.

Technical assistance during system development is available at most local HP sales and service offices, from resident systems engineers who specialize in desktop computers, computer systems, and instruments.

### How the HP-IB Operates

All active interface circuitry is contained within the various HP-IB devices, and the interconnecting cable (containing 16 signal lines) is entirely passive. The cable's role is



Automation provides the speed needed for production environments. This HP 8957S Cellular Test System produces accurate, hard-copy test results in minutes.

# HEWLETT-PACKARD INTERFACE BUS

## Versatile Interconnect System for Instruments and Controllers (cont'd)

### General Information



limited to that of interconnecting all devices in parallel so that any one device can transfer data to one or more other participating devices.

Every participating device (instrument, controller, accessory module) must be able to perform at least one of the roles of TALKER, LISTENER, or CONTROLLER. A TALKER can transmit data to other devices via the bus, and a LISTENER can receive data from other devices via the bus. Some devices can perform both roles. For example, a programmable instrument can LISTEN to receive its control instructions and TALK to send its measurement results.

A minimum HP-IB system consists of one TALKER and one LISTENER, without a CONTROLLER. In this configuration, data transfer is limited to direct transfer between one device manually set to "talk only" and one or more devices manually set to "listen only" for example, a measuring instrument talking to a printer for semi-automatic data logging).

A CONTROLLER manages the operation of the bus system primarily by designating which devices are to send and receive data, and it can also command specific actions within other devices.

The full flexibility and power of the HP-IB become more apparent, however, when one device that can serve as CONTROLLER/TALKER/LISTENER (e.g., calculator or computer) is interconnected with other devices that may be either TALKERS or LISTENERS, or both (e.g., frequency synthesizers, counters, power meters, relay actuators, displays, printers), depending on the application. An HP-IB controller participates in the measurement by being programmed to schedule measurement tasks, set up individual devices so that they can perform these tasks, monitor the progress of the measurement as it proceeds, and interpret the results of the measurement. Hewlett-Packard offers controllers that can be programmed in high-level languages such as BASIC, FORTRAN, HPL, and Pascal.



Rear panel switches are set so instrument will either be addressable by controller in a multi-device system, or will simply "talk only" to another device, such as a printer.

### HP-IB Connections and Structure

The HP-IB has a party-line structure. All devices on the bus are connected in parallel. The 16 signal lines within the HP-IB cable are grouped into three clusters according to their functions:

1. Data Bus (8 signal lines)
2. Data Byte Transfer Control Bus (3 signal lines)
3. General Interface Management Bus (5 signal lines).

The Data Bus consists of eight signal lines that carry data in bit-parallel, byte-serial format across the interface. These signal lines carry addresses, program data, measurement data, universal commands, and status bytes to and from devices interconnected in a system. Identification of the type of data present on the DIO signal lines is indicated by the ATN (attention) signal. When the ATN signal is true (asserted), either addresses or universal commands are present on the data bus and all connected devices are required to monitor the DIO lines. When the ATN message is false, device-dependent data (e.g., programming data) is carried between devices previously addressed to talk and listen.

Data transfer uses a set of three signal lines: DAV (data valid), NRFD (not ready for data), and NDAC (not data accepted).

These signals operate in an interlocked handshake mode. Two signal lines, NRFD and NDAC, are each connected in a logical AND (wired OR) to all devices connected to the interface. The DAV signal is sent by the talker and received by potential listeners. The NRFD and NDAC signals are sent by potential listeners and received by the talker.

The General Interface Management Lines manage the bus for an orderly flow of messages. The IFC (interface clear) message places the interface system in a known quiescent state. SRQ (service request) is used by a device to indicate the need for attention or service and to request an interruption of the current sequence of events. REN (remote enable) is used to select between two alternate sources of device program data. EOI (end or identify) is used to indicate the end of a multiple byte transfer sequence or, in conjunction with ATN, to execute a polling sequence.

It is not possible in this limited space to go into detail on each signal line's role. But you should note that every HP-IB device need not be able to respond to all the lines. As a practical and cost-effective matter, each HP-IB device usually responds only to those lines that are pertinent to its typical function on the bus. (Details are covered in each device's operating manual.)

### HP-IB and the new IEEE 488.2

In June of 1987, the IEEE approved a new standard for programmable instruments called IEEE Std. 488.2-1987 Codes, Formats, Protocols, and Common Commands. It works with the IEEE Standard Digital Interface for Programmable Instrumentation, IEEE 488-1978 (now 488.1). HP-IB is Hewlett-Packard's implementation of IEEE 488.1.

As with IEEE 488.1, Hewlett-Packard was active in the development of IEEE 488.2. Many of the new HP instruments introduced this year already follow this new standard, and many more HP instruments to be introduced in the near future will also follow IEEE 488.2.

This new standard addresses issues involved with sending messages between devices on the bus. Its features include:

- A required minimum set of IEEE 488.1 capabilities.
- Reliable transfer of complete messages between a computer and an instrument.
- A precise description of the syntax in those messages.
- A set of commands useful in all instruments.
- Common status reporting capability using serial poll.
- Techniques for guaranteeing synchronization of application programs with instrument functions.
- A way of automatically assigning addresses.

The desired benefit from these features is to make the job of an instrument system designer easier. IEEE 488 standardized the electrical and mechanical interface. This new standard ensures compatibility at the next higher level.

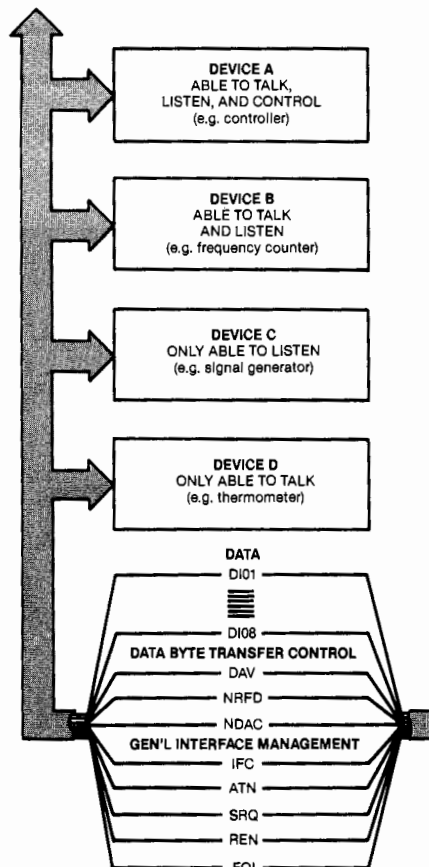

Interface connections and bus structure



### 488.1 Requirements

The IEEE 488.2 Standard requires that each device provide a minimum set of 488.1 interface capabilities. Each device must be able to source and accept bytes, talk and listen, do service request, and respond to device clear.

IEEE 488.2 allows more freedom by making other capabilities optional. However, it requires a minimum capability when these functions are implemented. This applies to the Remote Local, Parallel Poll, Device Trigger, and Controller capabilities.

### Message Exchange

IEEE 488.1 provides a reliable means of transferring bytes between a talker and a listener. In addition, devices need a reliable means of transferring programming commands and measurement results. IEEE 488.2 provides this means.

### Syntax

IEEE 488.2 requires that devices listen in a "forgiving" manner. However, the level of forgiveness is precisely defined. The meaning of every data byte is well defined, while several characters sometimes have the same meaning.

Although the listening syntax is forgiving, an instrument is required to talk precisely. Talking precisely greatly increases the chances of a message being accepted by any controller.

### Common Commands

Certain functions are useful across all types of instruments. IEEE 488.2 defines a set of commands that all instruments must implement. Required commands include identifying the instrument by manufacturer and model number, resetting the instrument to a known state, and performing a self-test.

Other commands that are useful in some instruments are also described in the standard. They are included so that, if the functions are implemented, they will be done in standard ways. For example, there are commands for calibration, triggering, macros, and passing control. There are a total of 13 required commands and 26 optional commands.

### Status Reporting

IEEE 488.1 exactly describes how the Request Service (RQS) message behaves, but it says very little about the status byte, STB. The meanings of the bits are left to the designer. Some instruments clear the status byte after a serial poll, others do not. Many instruments allow the programmer to configure what causes a service request, but here too the techniques for doing so are varied.

IEEE 488.2 describes a hierarchical status reporting model in which the contents of other data structures are summarized in the status byte. It does not specify the exact meaning of all of the bits in the status byte. However, it does describe the meaning of two more of the bits, Message Available (MAV) and Event Status (ESB).

### Synchronization

Many instruments can accept commands faster than they can execute them. Although this feature can improve system throughput, it also creates a need to know when the instrument actually completes all of its commands. IEEE 488.2 requires three common commands that enable the application program to detect when all pending operations are complete.

### Auto-configuration

Whenever a test system is assembled, the addresses of the instruments must be set to prevent collisions. Additionally, the application has to know the address of every instrument. Currently, addresses have to be set manually from the front panel or a bank of switches. IEEE 488.2 describes a protocol between the controller and all the auto-configurable instruments on the bus, which identifies each instrument and assigns it an address.

### Future

Codes, formats, protocols, and common commands cover new ground for instrument-to-computer communication. Most of the concepts involved can be used on any physical interface whether HP-IB, RS232, or VME. If a new physical interface should displace or co-exist with HP-IB, the syntax of messages, the common commands, the status reporting, and the synchronization techniques can all survive.

### HP-IB Training and Support

To assist you in configuring HP-IB measurement systems, Hewlett-Packard has field sales people trained in electronic instruments, desktop computers, and computer systems. Also available for technical consultation are computing controller systems engineers and HP-IB instrumentation specialists.

HP-IB training courses on HP-IB controllers and instruments are listed below. Courses are conducted at a convenient HP location. Some courses can be taught at your site with special arrangements.

- HP-IB Theory
- HP-IB for MOS-DOS® Personal Computers
- HP-IB Instrument Control Using HP Series 200/300 BASIC
- HP-IB Instrument Control Using HP 1000E/F Series Controllers

### HP-IB Service and Warranty

Hewlett-Packard has dedicated measurement system service people who perform on-site maintenance of HP instrumentation on customer-configured systems as well as HP-configured systems. Service contract coverage is available to meet your specific measurement system service needs and can be tailored to include extended warranty, calibration and extended hours of coverage. Contact your local sales and service office for further information on HP-IB service contract information.

MS-DOS is a U.S. registered trademark of Microsoft Corporation.

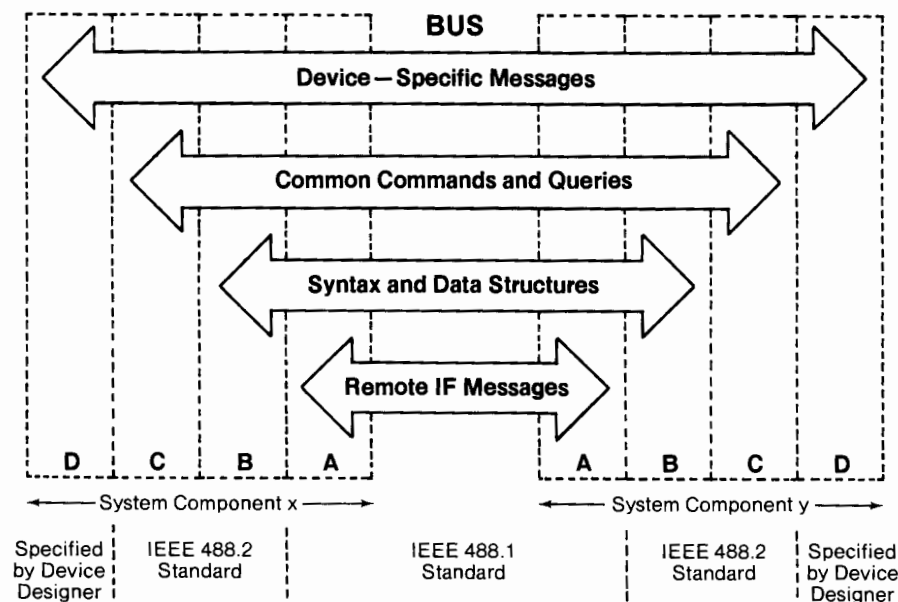

This diagram shows the relationship between the IEEE-488.1 standard and the new IEEE 488.2 standard. The new standard expands and complements IEEE 488.1 by addressing issues involved with sending messages between devices on the bus. Layer D represents device functions, layer C represents common system functions, layer B represents message communications functions, and layer A represents interface functions. Layers D, C and B contain IEEE 488.1 device-dependent messages and layer A contains IEEE 488.1 interface messages.

# HEWLETT-PACKARD INTERFACE BUS

## Versatile Interface Bus for Instruments and Controllers (cont'd)

### General Information



Every HP-IB device and HP-configured system carries a standard Hewlett-Packard warranty appropriate to that product. The warranty period for each product will be provided on request at the time of sale and is specified in documentation supplied with the product. HP takes responsibility for standard HP-IB systems performing as specified. However, software or interfacing that has not been provided by Hewlett-Packard as part of a standard system delivered by HP is not covered by this warranty.

In all cases, overall operational responsibility for those HP-IB systems assembled by a customer from individual HP-IB devices rests with the customer.

### HP-IB Specifications Summary

#### Interconnect Devices

Up to 15 maximum on one continuous bus.

#### Interconnection Path

Star or linear bus network; total transmission path length 2 meters times number of devices or 20 meters, whichever is less. Operating distances can be extended; see page 580.

#### Message Transfer Scheme

Byte-serial, bit-parallel asynchronous data transfer using locked 3-wire handshake technique.

#### Data Rate

One megabyte per second maximum over limited distance; 250-500 Kbytes per second typical over full transmission path (actual data rate depends on individual device characteristics).

#### Address Capability

Primary addresses, 31 TALK and 31 LISTEN; secondary (2-byte) addresses, 961 TALK and 961 LISTEN. Maximum of 1 TALKER and up to 14 LISTENERS at a time.

#### Control Shift

In systems with more than one controller, only one can be active at a time. A currently active controller can pass control to another, but only the designated system controller can assume control over others.

#### Interface Circuits

Driver and receiver circuits are TTL-compatible.

#### HP-IB Interface Functions

HP-IB functions are the predefined capabilities that can be designed into an HP-IB device. These capabilities and their alphanumeric codes are summarized in the table. Because the codes completely describe interface capability and are therefore particularly useful to system designers and specifiers, they frequently appear in technical data and on system components. On HP system-ready products the capabilities are listed near the HP-IB connector, and they are included in the specifications for most of the HP-IB products in this catalog.

#### HP-IB Connector Lock Screw Compatibility

HP-IB products delivered now and in recent years are equipped with connectors having ISO metric-threaded lock screws and stud mounts. Very early HP-IB products have non-metric parts, but are readily distinguished from the metric by color: metric-threaded parts are black, whereas non-metric parts have a shiny nickel finish. HP-IB Metric Conversion Kit (HP P/N 5060-0138) is available to convert these early instruments.

#### HP-IB Reference Publications

- *Tutorial Description of the Hewlett-Packard Interface Bus*. This 118-page reference chronicles the development of byte-serial, bit-parallel interface system

standards, describes their relationship to HP-IB, presents a working overview of HP-IB, and includes useful information. Published by Hewlett-Packard, part number 5021-1927.

- *ANSI/IEEE 488.1-1987, Digital Interface for Programmable Instrumentation, and IEEE Std. 488.2-1987, Codes, Formats, Protocols, and Common Commands*, published by the Institute of Electrical and Electronics Engineers, 345 East 47th Street, New York, NY 10017.
- *IEC 625-1, An Interface System for Programmable Measuring Apparatus (Byte Serial Bit Parallel)*, published by the International Electrotechnical Commission, 1 rue de Varembe, 1211 Geneva 20, Switzerland.

#### HP-IB Interface Capability Codes for HP Products

Interface Function	Basic Code	Capability Code
Source Handshake	SH	SH0 No capability
		SH1 Full capability
Acceptor Handshake	AH	AH0 No capability
		AH1 Full capability
Talker (Extended Talker)	T(TE)	T(TE)0 No capability
		T(TE)1 Basic talker, serial poll, talk only
		T(TE)2 Basic talker, serial poll
		T(TE)3 Basic talker, talk only
		T(TE)4 Basic talker
		T(TE)5 Basic talker, serial poll, talk only, unaddresses if MLA <sup>1</sup>
		T(TE)6 Basic talker, serial poll, unaddresses if MLA <sup>1</sup>
		T(TE)7 Basic talker, talk only, unaddresses if MLA <sup>1</sup>
		T(TE)8 Basic talker, unaddresses if MLA <sup>1</sup>
Listener (Extended Listener)	L(LE)	L(LE)0 No capability
		L(LE)1 Basic listener, listen only
		L(LE)2 Basic listener
		L(LE)3 Basic listener, listen only, unaddresses if MTA <sup>2</sup>
		L(LE)4 Basic listener, unaddresses if MTA <sup>2</sup>
Service Request	SR	SR0 No capability
		SR1 Full capability
Remote Local	RL	RL0 No capability
		RL1 Full capability
		RL2 No local lockout
Parallel Poll	PP	PP0 No capability
		PP1 Remote configuration
		PP2 Local configuration
Device Clear	DC	DC0 No capability
		DC1 Full capability
		DC2 Omit selective device clear
Device Trigger	DT	DT0 No capability
		DT1 Full capability
Driver Electronics	E	E1 Open collector (250kb/s max)
		E2 Tri state (1Mb/s max)
Controller <sup>3</sup>	C	C0 No capability
		C1 System controller
		C2 Send IFC and take charge
		C3 Send REN
		C4 Respond to SRQ
		C5 Send interface messages, receive control, pass control to self, parallel poll, take control synchronously

<sup>1</sup>MLA: My Listen Address

<sup>2</sup>MTA: My Talk Address

<sup>3</sup>There are 29 controller levels. These are the more significant levels.



# HEWLETT-PACKARD INTERFACE BUS

## Versatile Interconnect System for Instruments and Controllers

HP 59401A, 10833A/B/C/D, 10834A

579

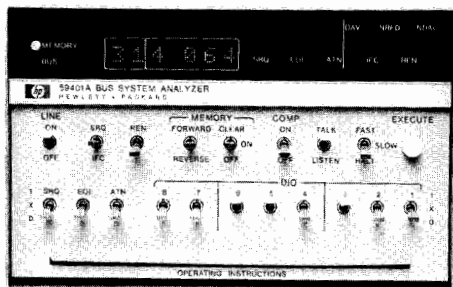

HP 59401A

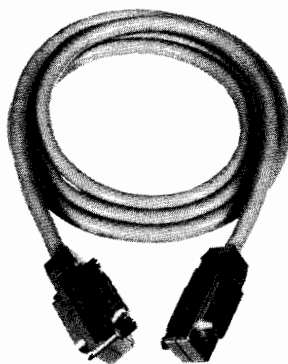

HP 10833A/B/C/D

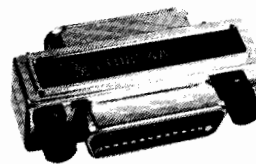

HP 10834A

### HP 59401A Bus System Analyzer

The HP-IB (IEEE 488) concept has greatly simplified many of those things which have in the past made instrument interfacing a burdensome task. Even so, software errors can occur if the system designer does not completely understand the bus system or the capabilities of the instruments and other devices being interfaced. Hardware problems can occur if the instruments/devices are not functioning properly, or if they are not completely compatible with the bus standard.

The HP 59401A Bus System Analyzer is especially useful in design and service work. It simplifies and speeds up the diagnosis of software and hardware problems by allowing the user to see the status of all bus lines, including the actual characters on the bus data lines. Because the HP 59401A can also drive all bus lines, it can completely exercise another Talker, Listener or Controller—which is especially useful in verifying compatibility of new or user-designed products with the HP-IB.

There are several choices of analyzer operating speed. It may be operated at one character at a time (useful for software debugging), at 2 characters per second, or at regular bus speed. It may also be operated at a variable rate as determined by the external clock input.

The analyzer's 32 character memory can be used to store bus characters in the Listen mode, or to output characters to the bus in the Talk mode. When the analyzer is in the Compare mode, a stream of bus traffic may be stopped on a pre-selected character—and at that time a trigger pulse is available, which is very useful when analyzing transient or timing problems related to the bus.

### HP 59401A Specifications

**Display:** monitors all bus lines. Represents data lines, any memory location, or DIO front panel switch settings; in octal code and ASCII character.

**Listen mode:** stores up to 32 characters of bus traffic in memory for real time and repetitive testing. In Compare mode, halts bus traffic when a selected character is present, and user can display any one of the previous 31 characters stored in memory.

**Timing:** accept <750 ns; ready <750 ns.

**Talk mode:** bus lines can be driven directly from front panel switches; memory can be loaded from front panel switches for driving bus with a 32 character sequence.

**Timing:** (1) data changed >500 ns before DAV pulled low; (2) ATN driven low >1 μs before DAV pulled low; (3) DAV driven high <700 ns after NDAC is false; (4) DAV driven low <700 ns after NRFD is false, if conditions 1 and 2 are met.

**Operating speeds:** one character at a time, 2 characters per second, regular bus speed, or variable rate determined by external clock input; in either Listen or Talk mode.

**External clock input:** 1 standard power TTL gate input; ≤10 MHz repetition rate.

**Compare output:** provides 1 standard power TTL gate output (LOW TRUE) sync pulse when bus character is same as front panel switches.

**HP-IB load:** 1 bus load (capable of driving 14 other bus devices).

### General

**Temperature ranges:** operating, 0 to 50°C; storage, -40 to +75°C.

**Humidity:** 95% relative, 0 to 40°C.

**Power requirements:** 100, 120, 220, or 240 V +5%, -10%; 48 to 66 Hz; ≤42 VA.

**Size:** 145.5 H, 205.1 W, 49.5 mm D (5.730" x 8.075" x 1.950").

**Weight:** net, 5.64 kg (12.44 lb).

### Accessories

HP 59401A Bus System Analyzer

HP 5061-9689(metric) front handle kit

HP 10833B 2 m (6.6 ft) bus cable, furnished

### Price

\$4170

\$55 ☎

### HP-IB Interconnection Cables

Cables for interconnecting HP-IB devices are available in four different lengths. The connector block at both ends of each HP-IB cable (photo above) has a plug on one side and a matching receptacle on the other, so that several cables may be conveniently connected in parallel, thus simplifying system interconnection. Lock screws provide for secure mounting of each connector block to an HP-IB instrument, or to another cable connector block.

**SPECIAL NOTE:** HP-IB cables are not always included with individual HP-IB devices, particularly those that normally connect directly to an HP computing controller. (The HP-IB interface for HP computing controllers contains the necessary cable and connector). Product listings in this catalog should be checked to see if HP-IB cables are furnished.

The HP 10833 series of cables feature an improved shielding design to help improve RFI levels in systems. This series of cables, with the RFI shielding, exhibits significantly lower radiated emissions than previous HP-IB cables.

The HP 10834A adapter is a shielded HP-IB to HP-IB adapter. It provides additional clearance (approximately 2.3 cm) between the HP-IB cable and the rear panel of the instrument. This allows easier access to switches, cables, and other connectors that may be in close proximity to the HP-IB connector.

### Ordering Information

HP 10833A HP-IB Cable, 1m (3.3 ft)

HP 10833B HP-IB Cable, 2m (6.6 ft)

HP 10833C HP-IB Cable, 4m (13.2 ft)

HP 10833D HP-IB Cable, 0.5m (1.6 ft)

HP 10834A Adapter

☎ For same-day shipment, call HP DIRECT at 800-538-8787

### Price

\$80

\$90

\$100

\$80

\$31



# HEWLETT-PACKARD INTERFACE BUS

## Versatile Interconnect System for Instruments & Controllers

HP 59306A, 59307A, 59309A, 59501B

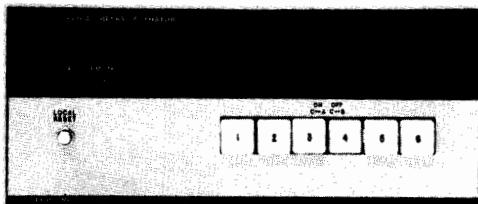

HP 59306A

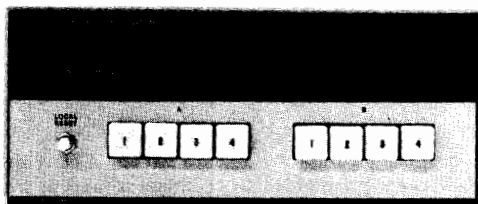

HP 59307A

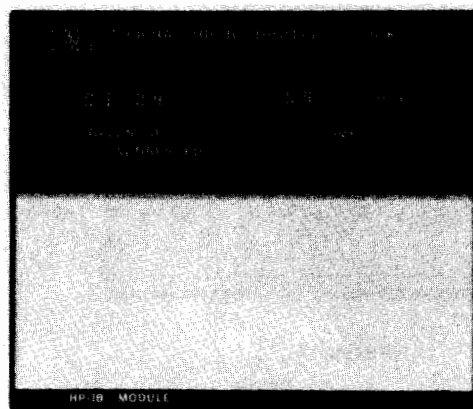

HP 59309A

DESIGNED FOR  
**HP-IB**  
SYSTEMS

### HP-IB Accessory Modules

Modules in the HP 59300, 59400 and 59500-series are ideal building blocks for use with instruments to extend measurement capabilities. Modules listed here can be interconnected via the HP-IB to HP measuring instruments, signal sources and recording devices capable of operating directly on the HP-IB. In addition, these modules frequently serve as useful ways to interconnect with devices which are not themselves capable of direct HP-IB operation.

#### HP 59306A Relay Actuator

Has six Form-C relays that provide for control of external devices either manually from front panel pushbuttons or remotely from the HP-IB. Relay contacts are specified to switch 28 V dc or 115 V ac at 0.5 A. Each relay can be programmed independently or multiple relays can be switched together. Front panel pushbuttons light to indicate the state of each relay.

The HP 59306A is ideal for providing control of microwave coaxial switches (HP 8761 A/B) as well as control of microwave programmable step attenuators (HP 8494 through 8496 G/H) using external dc power supplies.

#### HP 59307A Dual VHF Switch

This module provides two single pole 4-throw switches controlled from front panel pushbuttons or remotely from the HP-IB. The HP 59307A is a dc to 500 MHz 50  $\Omega$  switch designed to maintain fast pulse transition times. The switches are independent and bidirectional for optimum use in multiplexing 50  $\Omega$  signal lines into measuring instruments. The HP 59307A is ideal to switch a standard delay, frequency, or voltage into a measurement loop for purposes of system calibration.

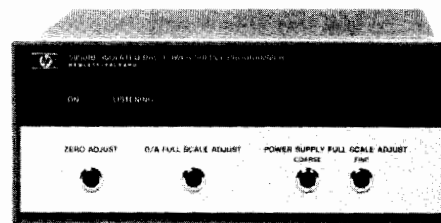

HP 59501B

#### HP 59309A HP-IB Digital Clock

Displays month, day, hour, minute, and second, and upon command will output time via the interface bus. Time can be set into the clock by local control, or by remote commands received from the HP-IB. The clock accepts a small internal battery which can provide more than a day's standby in case of short power interruptions. Additionally, an auxiliary power supply such as the K10-59992 can sustain the clock for up to one year.

#### HP 59501B Power Supply Programmer (isolated DAC)

This single-channel digital-to-analog converter can control a wide range of power supplies (output voltage, or current), as well as other analog programmable devices. It may also be used as a low level signal source, depending on the speed of the controller. It has two output ranges (0-1 and 0-10 V dc in unipolar mode; -1 to +1 and -10 to +10 V dc in bipolar mode), as well as photo-isolators which electrically separate HP-IB control and data lines from power supply circuitry by up to 600 V dc. (For additional details see page 491).

HP Model	Description	Dimensions—max. height x width x depth mm (inches)	Net Weight kg (lb)	Shipping Weight kg (lb)	Price
HP 59306A	Relay Actuator	101.6 x 212.9 x 294.6 (4 x 8.38 x 11.6)	2.64 (5.87)	3.23 (7.18)	\$2000
HP 59307A	VHF Switch	101.6 x 212.9 x 294.6 (4 x 8.38 x 11.6)	2.64 (5.87)	3.23 (7.18)	\$1750
HP 59309A	HP-IB Digital Clock	101.6 x 105.9 x 294.6 (4 x 4.17 x 11.6)	1.70 (3.78)	2.84 (6.31)	\$2900
HP 59401A	Bus System Analyzer	145.5 x 205.1 x 495.3 (5.73 x 8.08 x 19.5)	5.64 (12.44)	9.1 (20)	\$5075
HP 59501B	Power Supply Programmer	101.6 x 212.9 x 294.6 (4 x 8.38 x 11.6)	2.61 (5.80)	3.17 (7.04)	\$1000

# HEWLETT-PACKARD INTERFACE BUS

## Versatile Interconnect System for Instruments and Controllers

HP 37204A/B

581

- HP-IB extension up to 1250 meters (up to 3000 meters with fiber-optic cable)
- Data transfer rate up to 60 kbyte/s
- Cost-effective multi-drop capability; up to 30 remote sites
- Installation usually needs no software changes
- 100% error-free operation
- Industry-standard ST, FC and SMA fiber-optic connectors; fiber sizes from 50/125 to 100/140  $\mu$ m

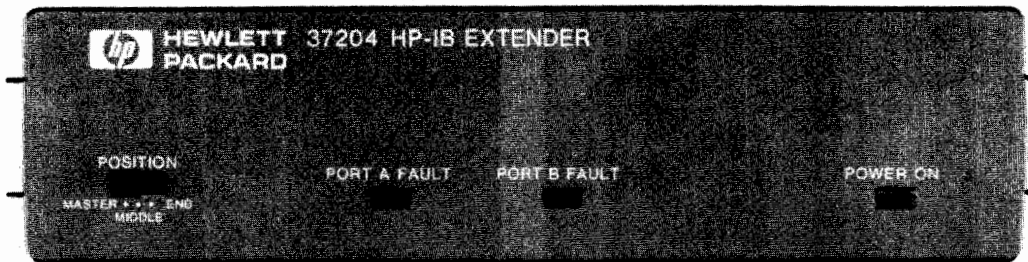

### HP 37204A/B



#### HP 37204A Multi-point HP-IB Extender

The HP 37204A extends the distance between HP-IB devices beyond the 2-meter limit. Users can link up to 31 HP 37204As (one per site) to achieve a multi-point system. Each link can be up to 1250 meters long (3000 meters with fiber-optic cable). Once installed, extenders operate automatically and transparently. Usually, programs can remain unchanged. Error correction ensures 100% data integrity. Partial HP-IB operation can continue after link failure by invoking truncation.

The HP 37204A supports all IEEE-488 functions, but might slow the response to a parallel poll beyond the 2  $\mu$ s limit. Extenders are listen-always devices that handshake data from a talker to all sites - if there is no addressed listener, the extender handshakes with itself. Because extenders limit the speed of all bus traffic to 60 kbyte/s maximum, extenders should be located on a separate HP-IB from disk/tape drives.

The table below shows examples of maximum speed against the number of extenders in a system. Note: For coaxial-cable links longer than 250 meters, link speed is 1/10 normal.

Average Inter-extender Cable Length	Number of Extenders per Chain		
	2	3	5
100 meters - coaxial cable	54 kbyte/s	26 kbyte/s	14 kbyte/s
100 meters - optical fiber	52 kbyte/s	25 kbyte/s	13 kbyte/s
500 meters - coaxial cable	5.9 kbyte/s	2.8 kbyte/s	1.4 kbyte/s
500 meters - optical fiber	36 kbyte/s	17 kbyte/s	9 kbyte/s

#### HP 37204B Multi-point HP-IB Extender

The HP 37204B is only for supported configurations of HP 256X/268X printers and HP 3000 computers.

#### Specifications

- Maximum distance:** 1250 meters per link (coaxial cable); 3000 meters per link (fiber-optic cable)
- Maximum speed:** 60 kbyte/s
- Power requirements:** 100/120/220/240V ac +5/-10%, 48 to 66 Hz, 10 VA max
- Size:** 71 H x 212 W x 254 mm D (2.8" x 8.3" x 10")
- Weight:** 1.72 kg (3.8 lb)
- Temperature:** 0 to 50 degrees C (operating); -40 to +70 degrees C (storage)
- Humidity:** 5% to 95% non-condensing
- Altitude:** up to 4600 meters (15000 feet)
- Compliance:** UL 478 & 114 listed  
CSA 22.2 No 220-1986 certified  
Complies with IEC 435 & 380  
Verified to FCC part 15 level B  
Complies with FTZ 1046-84

#### Ordering Information

- |   |                      |
|---|----------------------|
| <b>HP 37204A</b> Equipped with dual coaxial ports   | <b>Price</b> \$1,215 |
| <b>Opt 003</b> Fiber-optic interface, SMA type 905 connectors. For end extenders                            | \$495                |
| <b>Opt 004</b> Fiber-optic interface, SMA type 905 connectors. For middle extenders in a multi-point system | \$940                |
| <b>Opt 013</b> Fiber-optic interface, ST connectors. For end extenders                                      | \$495                |
| <b>Opt 014</b> Fiber-optic interface, ST connectors. For middle extenders in a multi-point system           | \$940                |
| <b>Opt 023</b> Fiber-optic interfaces, FC connectors. For end extenders                                     | \$495                |
| <b>Opt 024</b> Fiber-optic interface, FC connectors. For middle extenders in a multi-point system           | \$940                |
| <b>HP 37204B:</b> Equipped with dual coaxial ports  | \$1,450              |
| <b>Options common to HP 37204A and HP 37204B</b>  |                      |
| <b>Opt 303</b> Half-rack-width adapter for mounting adjacent to an instrument in an HP System II cabinet    | +\$87                |
| <b>Opt 305</b> Standard 19-inch rack-mount adapter; holds one or two HP 37204A/Bs                           | +\$87                |

For same-day shipment, call HP DIRECT at 800-538-8787.

# DATA ACQUISITION SYSTEMS

## General Information

- Reduce manufacturing costs
- Reduce product development time
- On-going payback
- Improve product quality
- Higher process throughput
- More process up-time

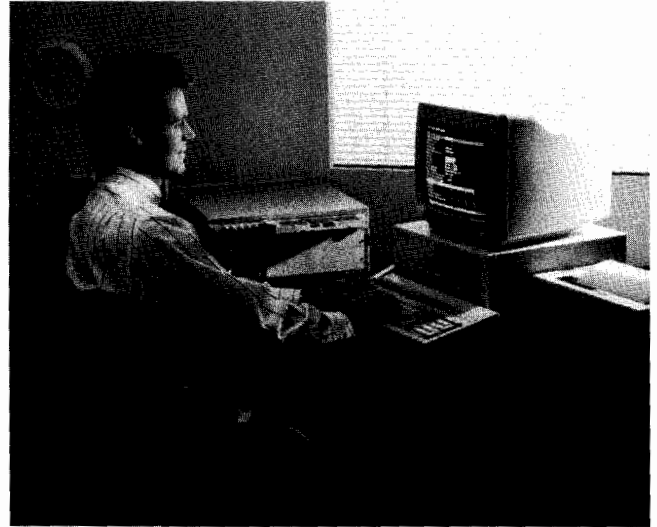

Every data acquisition system requires a combination of computers, instruments, transducers and software. The extent to which these pieces are packaged together is dependent upon your individual needs. Whether it is a completely integrated turnkey system, system components, plug-in board products or a customized in-house system, Hewlett-Packard can help. Turnkey solutions can be provided by HP's own

Customer Support Group or through an expanding network of independent systems integrators and software suppliers. Contact your local HP sales office for more information about these programs.

Information on data acquisition plug-in board products for HP 1000 and HP 9000 computers can be found on pages 640 and 642. Data acquisition software products are described on pages 600 and 610. Information

on instruments and computers for custom-built systems can be found under the headings for those products. The remainder of this section contains detailed information on data acquisition component systems. These systems provide solutions for a very broad range of applications. Contact your local Hewlett-Packard sales office for more information on how these systems can work for you.

### HP DATA ACQUISITION SYSTEM COMPONENTS

#### PRODUCT DEVELOPMENT & PHYSICAL CHARACTERIZATION

##### Instrument

- HP 3852A data acquisition/control unit
- \* Powerful built-in operating system
- \* Broad functionality with complete line of plug-in accessories

##### Software/computers

- HP DACQ data acquisition manager
- \* Data acquisition software tools
- \* Use with HP 9000 Series 300 technical computer, HP-UX workstation, or HP Vectra PC

##### Value-added suppliers

- \* Software packages available for all HP computers
- \* Expanding selection

#### BASIC RESEARCH

##### Bundled system

##### HP 75000 System 10

- \* PC-based menu-driven software
- \* Installed hardware and software

#### SCADA

##### Instrument

- HP 48000 remote terminal unit
- \* Designed for industrial environments
- \* Remotely locatable

##### Computers

- HP Vectra personal computer
- \* IBM PC/AT-compatible
- \* Independent HP BASIC language processor

##### HP 9000 Series 300 technical computer

- \* High performance
- \* Modular

##### HP 1000 real-time computer

- \* Real-time processing
- \* Multi-user operating system

##### Software

- \* Value-added suppliers

#### REMOTE ACQUISITION

##### Instrument

- HP 75000 Series B
- \* Stand-alone operation

#### PORTABLE ACQUISITION

##### Instrument

- HP 3421A data acquisition unit
- \* Low costs
- \* Portable

# DATA ACQUISITION SYSTEMS

Instruments for Measurement and Control

HP 3421A

583

- Up to 30 differential channels, 56 single-ended channels
- Electronic calibration for repeatable answers
- Built-in 5½ digit A/D converter with 1 μV sensitivity
- HP-IL (standard) and HP-IB (optional) with rear panel switch
- Optional 12 volt remote charging adapter

- "Sleep mode" for extended battery life in remote locations
- Front terminals for convenient DCV, ACV, 2 & 4-wire ohms, frequency and temperature
- Display shows channels closed, digital states and self-test conditions

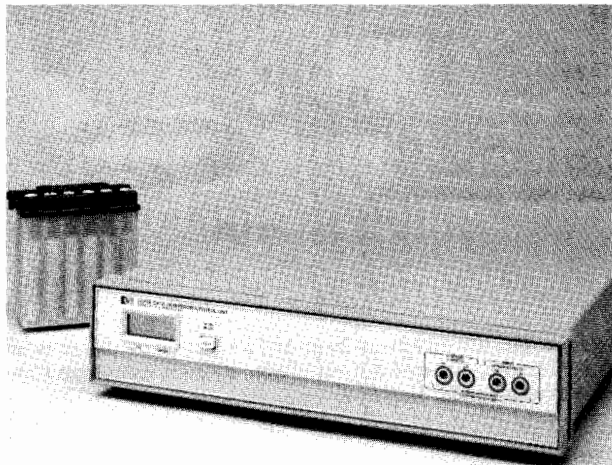

HP 3421A

## HP 3421A Data Acquisition/Control Unit

If your measurement needs exceed the capabilities of plug-in cards but don't quite call for a top-of-the-line data acquisition unit, the HP 3421A is just what you are looking for. The HP 3421A is the instrument that beats the high cost of data logging. Use it for small data acquisition projects with the assurance that it will quickly pay its own way. The HP 3421A can be configured with several different computers into a variety of systems designed for low to medium sized applications.

### The Instrument

The HP 3421A scans up to 30 channels, measuring DCV, ACV, 2- and 4-wire Ohms, Frequency, and Temperature. It also reads and writes digital information and stores up to 30 analog readings. The standard HP 3421A comes with an HP-IL interface for battery-powered flexibility or optionally HP-IB for more computational power.

The HP 3421A is battery-powered with latching relays that will not change state when the ac line power is removed.

Up to three of the following assemblies may be added to the HP 3421A mainframe:

- 10-channel analog multiplexer/actuator assembly with thermocouple compensation,
- 8-bit input/8-bit output digital assembly,
- Breadboard assembly for custom circuitry.

### Measurement Integrity

With its 5½, 4½, 3½ digit A/D converter, the HP 3421A can resolve 1 μV out of 300 mV to monitor thermocouples and other low-level transducers. Or it can read higher level signals by auto-ranging up to 300 volts dc.

## HP 3421A Mainframe Specifications

The HP 3421A mainframe comes with:

- A 5½, 4½, and 3½ digit integrating A/D converter
  - Built-in counter
  - Thermocouple compensation
  - Type T thermocouple linearization built in
  - HP-IL
  - 30-reading storage buffer
  - LCD 30 channel display with power and error indicators
  - Electronic calibration
  - Rechargeable battery
  - High level command set
- All specifications apply for relative humidity less than 85% at 30 degrees C.

### dc voltage

**Ranges:** 300 mV, 3 V, 30 V, 300 V, Autorange

**Basic accuracy:** ±(.009% reading + 3 counts); 5½ digits

**Reading rates:** 2 to 35 readings/second

## Ordering Information

**HP 3421A** Data Acquisition/Control Unit

**Price**

\$2,220

### Input and I/O Assembly Options

- Opt 020** 8 Channel Multiplexer/2 Channel Actuator Assembly +\$500
- Opt 021** 9 Channel Multiplexer/1 Channel Actuator Assembly +\$500
- Opt 022** 10 Channel Multiplexer Assembly +\$500
- Opt 040** Breadboard Assembly with connector block +\$115
- Opt 050** 8 bit in, 8 bit out Digital I/O Assembly with connector block +\$500
- Opt 201** add HP-IB interface. Allows use of EITHER an HP-IB or HP-IL controller +\$400
- Opt 214** add 12 volt remote charging adapter. Cannot be added if opt 201 is specified +\$530

### Field Installation Kits\*

- HP 44461A:** Add HP-IB interface. Allows use of either an HP-IB or HP-IL Controller (same as Opt 201) \$400
  - HP 44462A:** 8-Channel Multiplexer/2 Channel Actuator Assembly with thermocouple compensation, connector block. (Same as Opt 020. Can be reconfigured to same as Opt 021 or Opt. 022) \$500
  - HP 44463A:** extra connector block for HP 44462A \$60
  - HP 44464A:** Breadboard Assembly with connector block (same as Opt 040) \$115
  - HP 44465A:** 8 bit in, 8 bit out digital I/O assembly with connector block (same as Opt 050) \$500
  - HP 44466A:** Extra connector block for digital or breadboard assembly \$25
  - HP 44469A:** Seven 10:1 dividers for measuring 300 Vac \$25
- ### Accessories
- HP 11340A:** 20-meter HP-IL Cable \$120
  - HP 11340B:** 50-meter HP-IL Cable \$230
  - HP 11340C:** 100-meter HP-IL Cable \$445

\* Field installation is recommended to be performed only by service trained personnel.

# DATA ACQUISITION SYSTEMS

## PC-Based Data Acquisition

### HP 75000 PC Data Acquisition System 10



HP 75000 System 10

#### HP 75000 System 10

The HP 75000 System 10 is a PC-based data acquisition system that includes the HP 75000 cardcage, three measurement cards, a test block, and data acquisition software. The PC/printer option allows you to add an HP Vectra computer and HP QuietJet printer. Other plug-in measurement cards are also available to be used with this system.

Included in the System 10 are a 5½-digit multimeter, a 16-channel thermocouple relay multiplexer, and a quad 8-bit digital I/O card. These three cards are configured and built into the cardcage. Other measurement cards will be installed at the factory when ordered at the same time as the System 10.

LABTECH® NOTEBOOK is a menu-driven software package for data acquisition applications. The COMPANION software is an on-line job aid to assist you in learning about the software and configuring the hardware to your transducers. Other software like Lotus 1-2-3 can be used with LABTECH® NOTEBOOK for customized analysis of the data.

#### The Complete Solution

The System 10 is a complete solution to your data acquisition application. The complete system includes measurement hardware, data acquisition software, a personal computer and printer, and on-line documentation. It also includes a test block complete with transducers to help you test your system.

Hewlett-Packard has over 50 years of experience in building test and measurement instruments. With a full line of personal computers, software, and data acquisition equipment, Hewlett-Packard offers complete solutions to your data acquisition applications.

#### Easy-To-Use Software

The System 10 solution is designed specifically for data acquisition. LABTECH® NOTEBOOK software is menu-driven so that you do not have to write code. Sample software setups are included in the System 10 to get you started quickly. The COMPANION software assists you in learning the software and using the hardware without reading a manual.

#### Dependable Hardware

The System 10 hardware ensures that you get reliable measurements without effort on your part. Plug-in cards are properly configured at the factory, and the software includes an auto-configuration routine to adapt to your specific configuration. Hewlett-Packard has a reputation of building quality products with superb

reliability. The HP 75000 cardcage and its plug-in cards are rated with a mean-time-between-failures of over 20 years and comes standard with a three-year warranty.

#### Flexible Solution

No two data acquisition applications are the same. The cardcage architecture allows you to install a variety of different plug-in cards to match almost any type of transducer you have. The software supports any configuration of these cards. A seamless link to Lotus 1-2-3 or user-written code makes the software flexible enough for your most demanding tasks.

#### Worldwide Support

Hewlett-Packard offers worldwide support for the System 10. The HP sales force is technically-oriented to help you solve your measurement problems, and a highly trained team of HP system engineers is available to help customize these solutions.

#### Specifications

Relay Multiplexers	Relay	Thermocouple	Single-Ended
Channels	16	16	48
Offset	4 $\mu$ V	2 $\mu$ V	50 $\mu$ V
CMR	100 dB	100 dB	> 80 dB
Isolation	120 V dc	120 V dc	120 V dc

FET Multiplexers	FET	Thermocouple	Single-Ended
Channels	16	16	32
Offset	25 $\mu$ V	25 $\mu$ V	25 $\mu$ V
Resistance-on	10 <sup>8</sup> $\Omega$	10 <sup>8</sup> $\Omega$	100 $\Omega$
Resistance-off	200 $\Omega$	200 $\Omega$	200 $\Omega$

D/A Converter			
Resolution	16 bits (2.5 $\mu$ V)		
Accuracy	12 bits		
Isolation	120 V rms, 170 V dc		
Ranges	$\pm$ 10 V, $\pm$ 20 mA		

Digital I/O			
Isolation	TTL		

Counters	Totalizer	Universal
Max count	2 <sup>32</sup>	2 <sup>32</sup>
Resolution	9 ½ digits	10 ½ digits
Frequency	4 MHz	100 MHz
Input	$\pm$ 5 V or 42 V	$\pm$ 4 V or 42 V

Form C Switch		
Isolation	250 V dc	
Max current	1A	
Power	30 watts/channel	
Offset	7 $\mu$ V	



### Typical System Accuracy

Type	Range	Resolution	System accuracy <sup>1</sup>
dc voltage <sup>2</sup>	0.125 V	120 nV → 7.6 μV	0.023% + 9μV → 0.115% + 64 μV
	1V	1.0 μV → 61 μV	0.013% + 19μV → 0.1% + 204μV
	8V	7.6 μV → 488 μV	0.01% + 54μV → 0.1% + 1.5 mV
	64V	61 μV → 3.9 mV	0.015% + 1mV → 0.1% + 20mV
	300V	488 μV → 31 mV	0.015% + 5mV → 0.1% + 80mV
Strain <sup>3</sup>	Full bridge	0.01 με	
	1/2 bridge	0.02 με	
	1/4 bridge	0.04 με	
Thermocouples	B	+1000 to +1600°C	1.0°C
	E	0 to +1000°C	0.8°C
	J	+200 to +600°C	0.8°C
	K	-200 to +1200°C	0.5°C
	N14	+200 to +1200°C	1.0°C
	N28	-100 to +300°C	1.0°C
	R	+200 to +1600°C	1.2°C
	S	+200 to +1600°C	1.5°C
T	0 to +300°C	0.5°C	
Thermistors	2.25K	-80 to +80°C	0.06°C
	5000	-50 to 100°C	0.05°C
	10000	-80 to 120°C	0.06°C
RTDs (Platinum, alpha @ 100 C)	0.00392	-100 to +400°C	0.3°C
	0.00385	-100 to +800°C	0.4°C

<sup>1</sup> System accuracy does not take into account the accuracy of transducers. Thermocouples have typical accuracies of 1.5-5°C, thermistors have 0.1 to 1°C, and RTDs have 0.01 to 0.1°C.

<sup>2</sup> Resolution and accuracy specifications are for the multimeter and the relay multiplexers. If FET multiplexers are used, add 21 μV to the offset when used at room temperature.

<sup>3</sup> The accuracy of strain gage measurements are dependent on the strain gages used.

### Typical System Speeds

(msec)	Time required for single reading (rdg)	Time required* multiple channels (chl)
High speed burst (dc volts)		350 5000 rdgs
dc volts (relays)	10	85 16 chls
dc volts (FETs)	10	53 16 chls
Thermocouples (relays)	100	900 16 chls
Thermocouples (FETs)	100	900 16 chls
Thermistors	55	850 16 chls
RTDs	55	850 8 chls
Strain <sup>3</sup>	100	900 8 chls
Read from digital I/O	10	
Write to digital I/O	11	
Close Form C switch	30	
Write to a D/A output	14	
Read a counter total (10 Hz signal)	14	
Read a frequency (1 kHz signal)	80	

\* Available in Version 6.0 of the System 10 software (February 1991).

### Ordering Information

### Price

#### PC-based Data Acquisition Systems

**HP E1390B** HP 75000 System 10 \$5,750  
Includes LABTECH® NOTEBOOK and COMPANION software, HP 75000 Series B cardcage, 5 1/2-digit multimeter, 16-channel thermocouple relay, multiplexer, quad 8-bit digital I/O, HP-IB cable, and test block

**Opt 100 PC/printer** +\$4,650

Adds the HP Vectra computer, HP QuietJet printer, and cables. The data acquisition software and DOS are installed on the hard disk. The HP Vectra includes an 80286 microprocessor, 640K RAM, 3 1/2" floppy disk drive, 40 Mbyte hard disk drive, VGA color monitor, keyboard, and an HP 82335A HP-IB interface card.

#### Language Option

**Opt ABA** U.S. English (110V) \$0

**Opt ABB** Universal English (220V) \$0

#### Additional plug-in modules

**HP E1328A** 4-channel D/A converter \$1,100

**HP E1330A** quad 8-bit digital I/O \$600

**HP 1332A** 4-channel counter/totalizer \$900

**HP E1333A** 3-channel universal counter \$900

**HP E1345A** 16-channel relay multiplexer \$650

**HP E1346A** 48-channel single-ended relay multiplexer \$800

**HP E1347A** 16-channel thermocouple relay multiplexer \$750

**HP E1364A** 16-channel form C switch \$650

The following modules work with version 6.0 or later of the System 10 software. (Available February 1, 1991)

**HP E1355A** 8-channel 120 Ω strain relay multiplexer \$925

**HP E1356A** 8-channel 350 Ω strain relay multiplexer \$925

**HP E1351A** 16-channel FET multiplexer \$875

**HP E1352A** 32-channel single-ended FET multiplexer \$1,000

**HP E1353A** 16-channel thermocouple FET multiplexer \$975

**HP E1357A** 8-channel 120 Ω strain FET multiplexer \$1,125

**HP E1358A** 8-channel 350 Ω strain FET multiplexer \$1,125

LABTECH® NOTEBOOK is a registered trademark of Laboratories Technology Corporation. Lotus and 1-2-3 are U.S. registered trademarks of Lotus Development Corporation.

# DATA ACQUISITION SYSTEMS

Instruments for Measurement and Control

HP 3852A

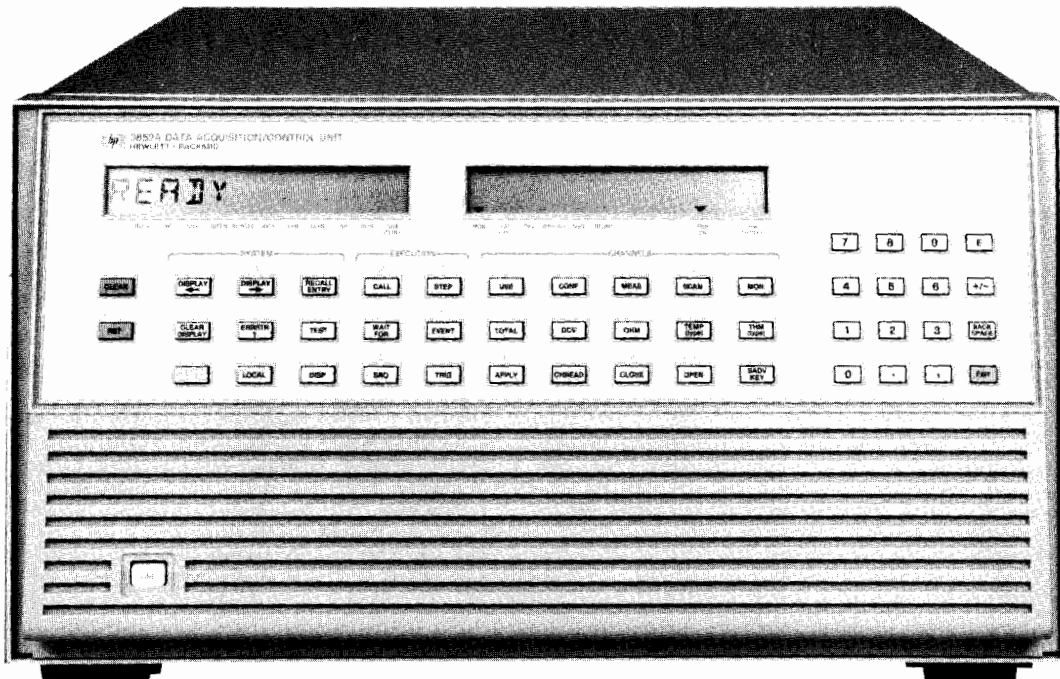

HP 3852A



## Configure the Capabilities You Need

You can easily configure an HP 3852S Data Acquisition and Control System to meet your needs for measuring physical parameters through transducers, and for providing control outputs. The HP 3852A Data Acquisition/Control Unit (mainframe) has eight slots for plug-in function modules. If more slots are needed, up to seven extenders can be added, each with ten additional slots. You can choose any combination of capabilities that include precision and high-speed plug-in voltmeters and a variety of analog and digital input/output functions.

A system clock and programmable pacer are built-in to drive your system. The clock — non-volatile for four years; 1 msec resolution—allows data to be time-stamped and events to be timed. The pacer—0.25  $\mu$ sec resolution—provides powerful capabilities to initiate and pace measurements, scans, or events.

## Include High-Speed and Accurate Analog Measurements in One System

Choose from two digital voltmeters to meet your measurement needs. For applications that require sensitive, accurate measurements in the presence of noise (for example, thermocouples), use the 5½-Digit Integrating Voltmeter and Relay Multiplexers. If you need speed, the 13-Bit High-Speed Voltmeter and High-Speed FET Multiplexers are the answer, providing single-channel bursts, channel-to-channel, random channel, full auto-ranging, and direct DMA transfers to a hard disc at an honest 100,000 readings/sec. The system voltmeters can be used in the mainframe or any extender, and multiple voltmeters are allowed per card-cage.

## Add Versatility and Expandability to Your System

With the HP 3852A Data Acquisition and Control System, you'll have available a complete set of input and output plug-in modules for interfacing to measurements and for controlling and sequencing your tests. Modules are available to handle physical measurements of temperature, flow, pressure, level, and strain. The HP-IB controller module gives you the capability to autoboot subroutines stored on a disc and to store data to the disc without computer assistance.

## Take Advantage of Extensive Front-End Intelligence

The HP 3852A mainframe has considerable built-in intelligence to increase the speed of collecting measurement and control data. Control decisions can be handled faster using subroutines running within the mainframe. This intelligence can be used to *return only significant data* to the computer, increasing its efficiency.

- Up to 5,500 readings can be stored in the standard HP 3852A mainframe. Expand this memory (used for storage of user routines as well as readings) to 256 kbytes, 1 Mbytes, 2 Mbytes, or 4 Mbytes with an Extended Memory board. Extended memory fits inside the mainframe controller module without using an I/O slot.

The power of this front-end intelligence in combination with an HP Series 300 Computer and the optional data acquisition software adapts easily to testing your complex product or characterizing your process. Of course, the mainframe can be also used with HP 1000 computers, HP Vectra PC, other IEEE-488 controllers and instruments, and a variety of computer peripherals.

## Reduce Your Test Development Investment

Optional data acquisition software for an HP Series 300/200 computer or HP Vectra PC gets your application running quickly and easily by providing off-the-shelf solutions for:

- Data base management — store large amounts of data in files that are easy to identify and access later.
- Graphics presentations — display or plot color graphs, display a real-time strip chart, plot data with linear, log, semilog, or automatic axis scaling.
- Data analysis — This software provides high-level subroutines as tools to be used in a test system program running with HP BASIC. Ease-of-use is exemplified by:
  - automatic creation of a data base for storing data using only one subroutine,
  - fast access to a single data item or a block of data items using only one subroutine,
  - manipulation and formatting of gathered data any way you wish.

Program development time is leveraged using this software, while allowing a powerful, highly customized system to be developed. Furthermore, the software can be used with any HP-IB instrument.

## Data Acquisition and Control Unit —

### HP 3852A

#### Mainframe Supports:

- Eight Function Module Slots
- Data Acquisition Operating System
- System Timer
- Measurement Pacer
- Full Alphanumeric Keyboard, Command and Result Displays

#### Benefits

- **Make real-time decisions and reduce data without burdening your computer:**
  - Multitasking operating system prioritizes and timeslices tasks
  - Powerful HP 3852A command statements simplify complex measurements.
  - Execution speed of command sequences are enhanced by executing subroutines stored in the HP 3852A memory.
  - Built-in, easy-to-use transducer conversions are supported for thermocouples, thermistors, RTDs, and strain gages.
  - Post-processing and data reduction before transferring results to a computer are achievable by first storing data to the HP 3852A internal memory.
  - Limit checking of analog measurements is performed in real time or after the measurements have been stored in mainframe memory.
- **Optimize measurement timing and throughput to meet your needs:**
  - Real-time interrupts allow higher priority tasks and external inputs to be serviced at any time
  - Asynchronous communication with a computer is achieved through input and output buffering.
  - Control can be timed using built-in clock and alarm capabilities (can cause an interrupt).
  - A built-in pacer simplifies measurement timing and triggering.
  - Multiple voltmeters can be used. The high-speed voltmeter can control scanning, timing, and triggering of its own high-speed FET multiplexer subsystem via ribbon cable. Several of these subsystems can run simultaneously.

## Data Acquisition Operating System

### Multitasking

Several subroutines called “run tasks” can be assigned equal priority and the operating system will timeslice them such that it appears they are running simultaneously. “Queued tasks” can be defined to run after certain conditions are met. Priority assignment allows complete control over front panel, HP-IB, interrupt, and run task execution.

### Real-time Interrupts

Interrupts from the front panel, HP-IB, plug-in accessories, or higher priority tasks are serviced immediately after the current command is done executing.

### Commands:

Powerful data acquisition commands are easy to remember and use. For example, “MEAS TEMPK <channel list>” performs K-type thermocouple measurements, cold-junction compensation, linearization, and channel scanning—ALL AUTOMATICALLY. In addition, <channel list> may be a short list of channels—or possibly the name of an array containing a much longer list.

### Down-Loaded Subroutines:

FOR...NEXT, IF...THEN...ELSE, WHILE...ENDWHILE Enhanced BASIC language constructs are available.

User subroutines with variables can be called for execution by a computer, other subroutines, or conditional interrupts.

### Transducer Conversions:

Transducer conversions have been optimized to support high system accuracy and speed for these transducers:

- \* Thermocouples
- \* Thermistors
- \* Platinum RTDs
- \* Strain Gages

### Special Conversions:

A special function permits user-defined tables of X,Y pairs to be used for linear interpolation (at a small price in memory usage, this function will typically execute much faster than high-order polynomial calculations).

### Limit Testing:

Perform limit testing in real-time (data is tested as it is measured) or as a post-process (data previously stored in arrays is tested). Limit test failures can cause an interrupt if enabled.

### Interrupts:

Time alarms, events that have just occurred, or limit tests of measurements can cause an HP-IB Service Request or a call to a stored subroutine.

### Math Operations:

+, -, \*, /, <, >, ATN, BINAND, BINCOMP, BINEOR, BINIOR, BIT, COS, EXP, LOG, SIN, SQR

### Scaling:

Offset and scale factors (mx + b) can be performed on an entire array using just one command.

### Statistics:

An easy-to-use function finds MIN, MAX, MEAN, and SIGMA (standard deviation) of the values stored in arrays.

## Extender Chassis — HP 3853A

### Extender Supports:

- Ten Function Module Slots

### Benefit

- **Expand your system with no loss of functional capability:**
  - Up to seven extenders may be used with each HP 3852A mainframe.
  - Any slot can be used for any function module and multiple voltmeters can be used with parallel triggering.
  - All mainframe functions, including interrupts and triggering, are available through the extender control cable.

### MULTITASKING OPERATING SYSTEM PRIORITY SCALE

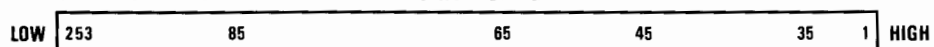

### RUN TASKS

- Maximum of 8 run tasks
- All tasks at the same priority will timeslice

### QUEUED TASKS

- Maximum of 20 subroutines queued to execute in the run tasks

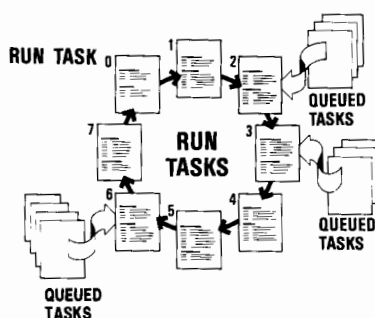

### INTERRUPT TASKS

- System alarm
- Limits
- Digital transition
- Counter overflow



### HP-IB TASKS

- Commands from a computer over HP-IB



### FRONT PANEL TASKS

- Commands entered from instrument front panel

# DATA ACQUISITION SYSTEMS

## Instruments for Measurement and Control (cont'd)

### HP 3852A

### 5½ to 3½ Digit Integrating Voltmeter

#### HP 44701A

Directly Measures:

- dc Voltage
- Resistance
- ac Voltage

#### Benefits

- **Accurately measure small signal changes in noisy environments:**
  - Integrating A/D rejects normal mode noise at multiples of the power line frequency.
  - Guarded input maximizes common-mode rejection.
- **Choose the resolution, accuracy, and noise rejection needed, while maximizing measurement speed:**
  - Integration selection (number of power line cycles) is key to optimizing these performance parameters.
  - This voltmeter provides the fastest dc reading rates available with power line-related noise rejection.
- **Optimize resistance measurements to the accuracy you need:**
  - Use two-wire ohms for measurements where lead resistance is not critical.
  - Use four-wire ohms where inaccuracies due to measurement leads cannot be tolerated (*most accurate measurement technique for RTDs*).
  - Use offset-compensated ohms to correctly measure resistance in the presence of series voltages (often caused by thermocouple effects).

#### dc voltage

#### Accuracy:

± (% of reading + volts), rear terminal input, one-hour warm-up, specified over time since last calibration, and operating temperature.

#### 90 Days, 18 to 28°C, Auto-zero On

Integration Time in Number of Power Line Cycles (NPLC)

	1	0.1	0.005	0.0005
<b>Range:</b>				
30 mV	0.02% + 6 μV	0.02% + 8 μV	0.02% + 20 μV	0.02% + 60 μV
300 mV	0.008% + 6 μV	0.008% + 10 μV	0.008% + 40 μV	0.008% + 400 μV
3 V	0.008% + 8 μV	0.008% + 40 μV	0.008% + 400 μV	0.008% + 4 mV
30 V	0.008% + 300 μV	0.008% + 700 μV	0.008% + 4 mV	0.008% + 40 mV
300 V	0.008% + 700 μV	0.008% + 4 mV	0.008% + 40 mV	0.008% + 400 mV

#### Reading Rate/Noise Rejection:

Integration Time in Number of Power Line Cycles (NPLC)

	1	0.1	0.005	0.0005
<b>Integration Time</b> 60 Hz (50 Hz)	<b>16.7</b> (20.0) ms	<b>1.67</b> (2.0) ms	<b>100</b> (100) μs	<b>10</b> (10) μs
Number of Converted Digits	6½	5½	4½	3½
Reading Rate (readings/sec) with auto-zero, auto-range off 60 Hz (50 Hz)	57 (48)	415 (360)	1350 (1350)	1600 (1600)
Min Noise Rejection (dB) Normal Mode Rejection at 50 or 60 Hz ± 0.09%	60	0	0	0
DC Common Mode Rejection with 1 kΩ in low lead	120	120	120	120
Effective Common Mode Rejection, at 50 or 60 Hz ± 0.09% with 1 kΩ in low lead	150	90	90	90

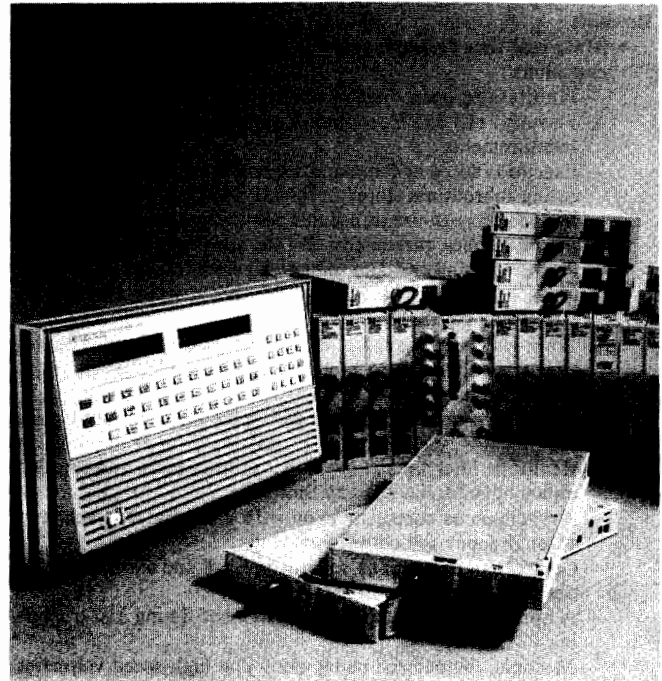

### 13-Bit High-Speed Voltmeter

#### HP 44702A/B

Directly Measures:

- dc Voltage
- dc Resistance

#### Benefits

- **Collect data quickly:**
  - A measurement rate of 100,000 readings/sec with auto-ranging is achieved by directly controlling up to six (eight in an extender) High-Speed FET Multiplexers through a dedicated ribbon cable.
  - Multiple High-Speed Voltmeters can be triggered simultaneously and operate independently.
- **Maximize your measurement throughput:**
  - On-board buffer is included for over 8,000 readings (HP 44702A) or over 64,000 readings (HP 44702B) that can be transferred to mainframe internal memory or to hard disc via GPIO and a DMA controller while taking measurements.
  - Dedicated triggering is achieved with on-board pacers.
  - Balanced input, equal impedance between high-to-chassis and low-to-chassis, gives good common mode noise rejection.

#### dc voltage

#### Accuracy:

± (% of reading + volts), rear terminal input, one-hour warm-up, specified over time since last calibration, and operating temperature, with auto-zeroing performed within one minute of measurement.

90 Days, 18 to 28°C

	Accuracy
<b>Range:</b>	
40 mV	0.05% + 68 μV
320 mV	0.05% + 234 μV
2.56 V	0.05% + 1.88 mV
10.24 V	0.05% + 7.5 mV

**Reading Rates:**

100,000 readings/sec with auto-ranging. Proper auto-ranging is ensured as long as a single-channel signal changes no more than 600 volts/s during auto-ranging.

**Noise Rejection:**

Min effective common mode rejection specified in dB for DC to 60 Hz with 1 k $\Omega$  in low lead; maximum signal (high to low) + common mode voltage (low to chassis) for proper operation is  $\pm 10.24$  volts.

ECMR	
<b>Range:</b>	
40 mV	90
320 mV	80
2.56 V	70
10.24 V	70

**Relay Multiplexers****HP 44705A/44705H/44706A/44708A/44708H/44717A/44718A**

Directly Multiplexers:

- Voltage
- Resistance
- Thermocouples
- Strain Gages

**Benefits**

- **Reduce the effects of real-world measurement errors in a multi-channel system:**
  - Relay multiplexers minimize errors due to thermal DC offsets, crosstalk, and injected (bias) currents.
  - The relay multiplexers have high, low, and guard terminals to maximize common mode noise rejection.
  - A single-ended multiplexer (HP 44706A) lowers your cost per channel.
  - With shunt and series jumpers in each channel of the HP 44705A/H and 44708A/H multiplexers, you can easily install a one-pole low-pass filter for additional noise rejection, a voltage divider to extend relay lifetime, or a shunt resistor to measure current.
  - Differential or common mode voltages up to 350 V peak or 250 Vdc can be handled by the HP 44705H and 44708H modules.
  - Scanning is break-before-make to prevent inadvertent connections of circuits being measured.
  - Each lead to the back-plane and common terminals has a 100 $\Omega$  resistor in series to prolong the lifetime of the relay contacts. Because of placement, these resistors contribute no error when measuring 2-wire ohms resistance using the HP 44701A Integrating Voltmeter. The resistor can be shorted, but this can seriously shorten relay contact life if relatively high voltages or currents are switched.
  - Tree switch relays automatically isolate each bank of relays from the back-plane to reduce crosstalk and improve settling time.
- **Optimize thermocouple measurement accuracy:**
  - Thermocouple types can be mixed on the HP 44708A/H multiplexer to optimize accuracy over the temperature ranges needed.
  - Thermocouple compensation is handled automatically with no extra wiring.
- **Measure strain accurately:**
  - Strain sensitivity can be optimized using finger-moveable jumpers to select between 1/4-, 1/2-, and full-bridge configurations. The HP 44717A and 44718A multiplexers each support 10 bridges for 120 $\Omega$  and 350 $\Omega$  strain gages.
  - No manual adjustments are required to balance the bridge.
  - Strain accuracy is independent of long-term bridge excitation voltage changes because the excitation voltage is automatically measured and included in the strain calculations.
  - The excitation voltage is always applied, never switched, reducing errors due to dynamic heating and cooling of the gages.
  - Connection to an available Wagner ground reduces errors due to gage leakage current.

**Solid State Relay Multiplexers - HP 44705F/44708F**

Directly multiplexers:

- Voltage
- 4-wire ohm resistance (HP 44705F only)
- Thermocouples (HP 44708F only)

**Benefits**

- **Solid state switching is free from wearout normally associated with electromechanical relays:**
  - Solid state relay multiplexers do not rely on a mechanical system to actuate the switching. Switching is performed by an optically coupled field effect transistor.
  - The switching element does not degrade when used within its maximum rating. The solid state relay is free from the damaging arc associated with electromechanical relays.
- **Perform precision measurements of real world electrical signals:**
  - Three wire switching of high, low, and guard is provided to minimize the effects of common mode voltage.
  - Errors due to injected currents and thermal offsets are minimized with the solid state relay multiplexer.
  - Break-before-make switching prevents inadvertent connection of separate channels during scanning.
  - Tree switching isolates the unused multiplexers from the backplane of the HP 3852A.
  - Internally, the solid state relay card is divided into two groups to minimize crosstalk and facilitate 4-wire resistance measurements.
  - The solid state relay becomes a high impedance when powered down thereby isolated each channel in the event of power loss.
- **Optimize thermocouple measurement accuracy with the HP 44708F:**
  - Thermocouple types can be mixed on the HP 44708F multiplexer to optimize accuracy over the temperature ranges needed.
  - Thermocouple compensation is performed automatically by the HP 3852A without external wiring.

**HP 44789A Serial Interface**

Directly provides:

- Serial programming port for the HP 3852A
- Control port for RS-232 or RS-422 devices

**Benefits**

- **Interface your computer to the HP 3852A using RS-232 or RS-422.**
  - Use your computer's standard RS-232 or RS-422 interface for complete access to the HP 3852A. The HP 44789A provides an alternative to the built-in HP-IB interface.
- **Locate the HP 3852A long distances from your host computer.**
  - Implement a remote data acquisition design by using the serial interface modems as well as a direct connection.
- **Control RS-232 or RS-422 devices directly from the HP 3852A.**
  - Offload your host computer by using the serial interface to communicate directly with RS-232 or RS-422 devices.
- **Program the HP 3852A from a remote terminal.**
  - Use your standard data terminal to send commands to the HP 3852A. List the data read from the HP 3852A on your terminal's CRT.

**Specifications**

**Baud rates:** 300, 600, 1200, 2400, 4800, 9600, and 19200

**Interrupts:** special character, buffer conditions, carrier detect, ring indicator, and receiver error conditions

**Handshake:** none, XON/XOFF, hardware, and both

**Buffer size:** user defined up to 8 kbyte on both transmitter and receiver

# DATA ACQUISITION SYSTEMS

## Instruments for Measurement And Control (cont'd)

HP 3852A

### FET Multiplexers

HP 44709A/44710A/

44711A/44712A/44713A/44719A/44720A

Directly Multiplexes:

- Voltage
- Thermocouples
- Resistance
- Strain Gages

#### Benefits

- **Maximize your measurement throughput:**

- A throughput rate of 100,000 readings/sec is realized using High-Speed FET Multiplexers (HP 44711A/44712A/44713A) directly controlled through a dedicated ribbon cable by the 13-Bit High-Speed Voltmeter.
- Up to six (eight in an extender) High-Speed FET Multiplexers can be controlled through this ribbon cable.
- The 24-channel multiplexers switch high and low only. Each floating input is balanced (that is, equal impedance between high-to-chassis and low-to-chassis) to provide good common mode noise rejection.
- For lower costs per channel, single-ended multiplexing of 48 channels (HP 44712A) is also available (has no common mode noise rejection, however).

- **Increase system reliability:**

- FETs have no mechanical limitations (no wear out due to switching).
- Similar to their relay counterparts, the HP 44709A/44710A/44719A/44720A FET multiplexers have high, low, and guard connections for better common mode rejection than the high-speed FET multiplexers.

### 4-Channel Track/Hold with Signal Conditioning

HP 44730A

### 4-Channel Dynamic Strain Gage Multiplexers

HP 44732A/44733A

Directly Multiplexes

- Transient DC voltages
- Dynamic strain gages
  - The Track/Hold Multiplexers have powerful capabilities for applications in acoustic analysis, environmental tests and the testing of engines, electromechanical products, mechanical products, rubber belts, elevators, hydraulics, motors, pressure transducers and materials.
  - Dynamic strain applications include seismology/ground characterization, machine control and characterization, and physical tests of engines, aircraft, mechanical products, hydraulics and motors. Tests using strain gages include operating and burst tests, as well as the simultaneous detection of "glitches."

#### Benefits

- Enhance dynamic signal measurement accuracy by measuring a number of channels simultaneously via internal or external strobes.
- Set gains of 1, 10, or 100 on each channel to amplify low level signals and improve measurement accuracy.
  - Select offset voltage nulling on each channel, minimizing computation time to obtain higher reading rates.
  - Reduces settling errors when switching between low-level and high-level signals.
- Use the analog peak detect/hold feature to capture either positive or negative peaks without having to sample at a high rate of speed.

- Boost system throughput in some applications by reducing the requirements to over-sample. Using the ribbon cable, it connects to the HP 44702 high speed voltmeter for high speed operations.
- Measure dynamic strain accurately.
  - Utilize on-board excitation that is provided separately for each bridge.
  - Select quarter, half, or full-bridge configurations.
  - Eliminate offsets with electronic nulling.

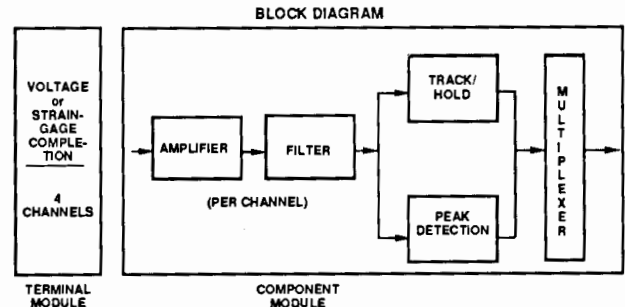

### Arbitrary Waveform Digital to Analog Converter

HP 44726A

Directly Outputs

- Arbitrary Waveforms
- DC Voltages

This 2-channel non-isolated module provides arbitrary waveforms and stimulus signals for product test and characterization applications. Applications include the testing of satellites, engines, electromechanical products, aircraft, automobiles, mechanical products, materials, chemicals and elevators.

#### Benefits

- Provides a stimulus voltage signal with a step rate of up to 800 kHz.
  - Outputs a DC voltage or any arbitrary waveform stores in its own memory.
  - Output waveforms, once initiated, can run continuously regardless of the activities being performed by the HP 3852A mainframe.
  - Channels have independent timebases that can be synchronized with each other or with external events. External timebases can also be used.
  - Waveforms can be single-shot (one cycle of the waveform) or continuous. Channel 0 can also perform n repetitions of the waveform (n = 1 to 65,536).
  - Sine, triangle and square (50% duty cycle) waveforms can be calculated and loaded from the HP 3852A with one command.
- Random access memory is available for each channel on this accessory.
  - Each channel has enough memory for 32,400 waveform points in which each point is defined as both a voltage level and length of time at that level. As a result, memory is used efficiently.
  - Up to 64 different waveforms on each channel can be stored in memory.
  - Arbitrary waveforms can be loaded from a user-defined array or a real array or high-speed voltmeter readings.

## Digital to Analog Converters

### HP 44727A/44727B/44727C

Directly Outputs:

- dc Voltage
- dc Current

#### Benefits

- **Simplify your test system by providing test or control of devices with one data acquisition control system:**
  - Four channels are provided on each module.
  - Each channel can be configured using finger-movable jumpers to output either unipolar or bipolar voltage, or unipolar current. Reconfiguration may require recalibration of the changed channel. Recalibration consists of adjustments to zero offset and gain potentiometers, and can be performed with the HP 44701A Integrating Voltmeter or equivalent. Three configurations (4-Channel Voltage—HP 44727A; 4-Channel Current—HP 44727B; 2-Channel Voltage, 2-Channel Current—HP 44727C) are available to make reconfiguration unnecessary in most cases.
  - Channels are isolated and can be connected in parallel for current or in series for voltage to expand the usable ranges.
  - Each channel configured for voltage has remote sense capabilities to ensure accurate voltages at the device.

#### dc voltage

**Ranges:** 0 to +10.235 V or -10.235 to +10.235 V

**Resolution:** 2.5 mV (12 bits plus a sign bit for bipolar range)

#### dc current

**Ranges:** 0 to +20.16 mA or +4 to +20.16 mA

**Resolution:** 2.5  $\mu$ A (13 bits)

## 3-Channel Stepper Motor Controller

### HP 44714A

Directly Provides:

- Stepper Motor Control Signals
- Limit Inputs
- Built-in Quadrature Counters
- Pulse Output

#### Benefits

- **Completely control three stepper motors with one module:**
  - Output a continuous stream or a fixed number of pulses.
  - Program separate acceleration and deceleration rates for trapezoidal motion profiles.
  - Halt output pulses when limits are reached or from the emergency stop input.
  - Built-in quadrature counter on each channel gives position feedback.
- **Use the module as a pulse generator.**
  - Output a set number of pulses or a continuous stream.
  - Set, accelerate, and decelerate both pulse width and pulse rate.

Trapezoidal Motion Profile

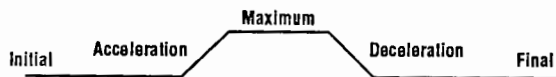

## 5-Channel Counter/Totalizer

### HP 44715A

Directly Provides:

- Count Measurements
- Period Measurements
- Frequency Measurements
- Interrupts

#### Benefits

- **Reduce your costs by taking advantage of frequency counting versatility:**
  - The counter/totalizer accurately measures logic or RMS inputs with frequencies up to 200 kHz.
  - By multiplexing between five isolated channels and five non-isolated channels, a total of ten connected channels is possible (only five can operate simultaneously).
  - Each DC logic channel independently counts on either positive or negative signal transitions. Non-isolated, low-level RMS inputs are measured using a zero-crossing detector.
  - Any channel that is totalizing can be programmed to set an interrupt for a counter roll-over to zero.
  - For isolated DC inputs, nominal voltages are separately selected for each channel by finger-movable jumpers. For non-isolated inputs, either TTL or low-level RMS inputs are also separately selected for each channel by finger-movable jumpers.
  - Debounce times (common to all channels) can be programmed to prevent false counts.
  - With shunt and series jumpers in each channel, you can easily install a one-pole low-pass filter for rejection of unwanted signals.

## Digital Inputs with Totalize and Interrupt

### HP 44721A/44722A

Directly Provides:

- Logic Readings
- Totalize Count Measurements
- Interrupts

#### Benefits

- **Conveniently read a variety of digital values in your system:**
  - Isolated inputs detect the presence of DC (HP 44721A 16-channel digital input) or AC (HP 44722A 8-channel digital input) inputs based on nominal voltages selected by finger-movable jumpers.
  - Each channel can independently totalize positive or negative (whichever is selected) logic transitions.
  - Voltage selection and function can be set independently on each channel.
  - Any channel can be programmed to set an interrupt for an edge occurrence (positive or negative) or a counter roll-over to zero.
  - Debounce circuitry that is common to all channels prevents erroneous readings on inputs that are still changing after a logic level transition.
  - For detecting whether switches are opened or closed, the HP 44721A has a non-isolated five volt supply at the terminal module with 9.4 k $\Omega$   $\pm$ 10% pull-up resistors on each input.

# DATA ACQUISITION SYSTEMS

## Instruments for Measurement and Control (cont'd)

HP 3852A

### 32-Channel High-Speed Digital Sense/Control

#### HP 44723A

Directly Provides:

- High-speed Digital Input and Output
- Triggered Input and Output
- Interrupts
- Output Handshaking

#### Benefit

- Input 16 channels or output 16 channels over 150,000 times per second.
- Capture and load 16-bit patterns with external triggers.
- Interrupt on any input channel on any transition or on a user-specified 16-bit pattern.

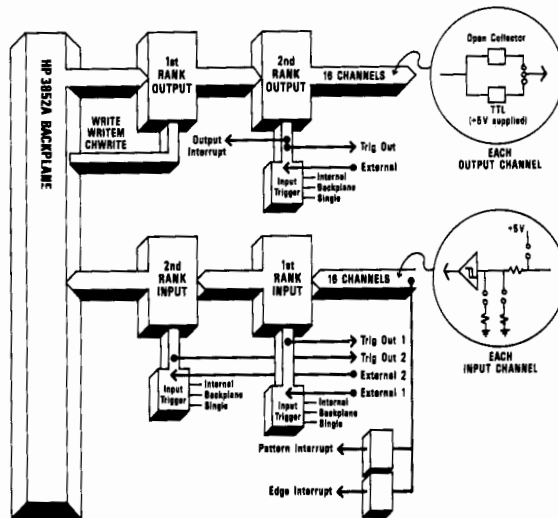

High-Speed Digital Sense/Control

### 16-Channel Digital Output

#### HP 44724A

Directly Provides:

- Open Drain Digital Outputs

#### Benefit

- Conveniently control dc devices or logic levels:
  - Open drain outputs are used to control dc devices with up to 55 V, or drive TTL logic levels. An external power supply and external pull-up resistors are required.

#### Characteristics

##### Max Input Voltage:

Between High and Low Terminal of Each Channel — 55 V dc  
Between Channels or Between Any Terminal and Chassis — 354 V peak or 250 V dc

**Max Sink Current:** 500 mA dc per channel (1 A fuse protection)

**Max Reverse Polarity Current:** 500 mA dc per channel

**TTL Compatibility:** 200 mA per channel with  $V_{out} \leq 0.4$  volts

### Switching

#### HP 44725A/44728A/44729A

Directly Switches:

- Voltage
- Current
- Power

#### Benefit

- **Reliability switch the voltage, current, or power you need:**
  - Both the HP 44725A and 44728A use single-pole double-throw (SPDT) Form-C relays that return to their normally

closed positions at power down. The HP 44725A 16-channel general purpose relays are for switching low-level power or moderate voltages and currents in an experiment while minimizing errors due to cross talk and thermal DC offsets. More dc or ac power can be switched with the HP 444728A 8-channel relay actuator.

- The HP 44729A 8-channel ac power controller distributes ac power. It switches "on" at the zero voltage crossing and "off" at the zero current crossing for long device life and low transient generation. Each channel has a relay and solid state switch in parallel to provide an exceptional combination of switch life and low on-resistance.

#### Characteristics

	Module		
	HP 44725A	HP 44728A	HP 44729A
Max Input Voltage ( $V_{max}$ ) Per Channel	30 V DC or RMS, 42 V peak	300 V DC, 250 V RMS	— 250 V RMS, 354 V peak
Max Input Current Per Channel	1.5 A DC, 1.5 A RMS	2 A DC, 3 A RMS (5 A fuse protection)	2.5 A RMS (3 A RMS if module is limited to 16 A RMS total; 4 A fuse protection per channel)

### Binary Mode Software

#### HP 44790A

The HP 44790A Binary Mode Software is a collection of special subprograms used to access high speed opcodes within the HP 3852A. This collection helps the system programmer to increase the run time speed of many data acquisition functions up to five times as fast as the standard high-level commands.

The binary mode software is written for the programming professional familiar with opcode programming. HP systems engineers can provide consulting services for those unfamiliar with this type of programming.

The binary mode software accesses over forty high-speed opcodes to support the following functions:

- Analog inputs using the HP 44702A/B High Speed Voltmeter
- Analog outputs using the HP 44727A/B/C DAC
- Digital I/O using the HP 44721/22/23/24A Digital Input/Output

- Data moves between memory, I/O slots, and HP-IB
- Statistics and limit checking
- Microcode instructions such as push, pop and rts

#### System Requirements

The binary mode software requires HP 3852A firmware revision 3.5 or later. It is supplied on a 3½-inch single-sided disk. The subprograms contained are written in HP BASIC, in modular form, so that they can be ported to other languages.

### HP-IB Controller

#### HP 44788A

Directly controls:

- HP-IB disk drives (CS80/SS80)
- HP-IB printers
- HP-IB instruments

#### Benefits

- Remote operations without a computer
- At power-up, load subroutines into an HP 3852A from an HP-IB disk drive and start executing them.
- Send data to an HP-IB disk drive without using a computer.
- Print out data stored in the HP 3852A without using a computer.
- Control other HP-IB instruments directly with HP 3852A.





### Ordering Information

To order, specify an HP 3852S System with the appropriate software, controller, mainframe, extenders, function modules, racks, and extra terminal modules. The HP 3852S itself has no cost—each component of the system is priced individually.

### Data Acquisition Manager

	<b>Price</b>
<b>HP 44458A</b> Data Acquisition and Control Software for Series 300/200 Computers on 3½" and 5¼" diskettes (BASIC 4.0 and 5.0)	\$2,055
<b>HP 44458R</b> License to Reproduce HP 44458A or 44458B. Includes one set of software manuals.	\$1,255
<b>HP 44459A</b> Data Acquisition and Control software for HP Vectra Computers on 3½" and 5¼" diskettes (BASIC 5.0)	\$1,530
<b>HP 44459R</b> License to reproduce HP 44459A/44459B. Includes one set of software manuals.	\$955

### Mainframe

<b>HP 3852A</b> Data Acquisition and Control Unit	\$4,110
<b>HP 44703A</b> Mainframe Extended Memory Card—256 kbytes*	\$780
<b>HP 44703B</b> Mainframe Extended Memory Card—1 Mbyte*	\$1,715

\*Only one extended memory option may be added per mainframe.

Extended memory cards for 2 Mbytes and 4 Mbytes can be ordered from Infotek Systems, 1045 S. East Street, Anaheim, CA 92805-8508, as AM220B and AM244B, respectively. These products have been *functionally tested, but are not warranted or supported by HP* (no RFI or environmental tests were conducted). Warranty for two years and support of individual cards are provided by Infotek.

### Extender Chassis

<b>HP 3853A</b> Extender Chassis with ten additional slots for function modules. A 1-meter extender control cable, and two 1-meter (3 wires each) analog signal extender cables are included. A total of seven extenders may be added to a mainframe. Extender control cables are always needed. Analog signal extender cables are needed if analog voltages must be switched to the mainframe or another extender.	\$2,720
---	---------

### Voltmeters

<b>HP 44701A</b> 5½ to 3½-Digit Integrating Voltmeter	\$1,725
<b>HP 44702A</b> 13-Bit High-Speed Voltmeter (100,000 readings/sec; buffer for over 8,000 readings)	\$2,930
<b>HP 44702B</b> 13-Bit High-Speed Voltmeter (100,000 readings/sec; buffer for over 64,000 readings)	\$3,535
<b>HP 44703C</b> High Speed Extended Memory Card for expanding HP 44702A Buffer to over 64,000 readings	\$680

### Relay Multiplexers

<b>HP 44705A</b> 20-Channel Relay Multiplexer	\$910
<b>HP 44705H</b> 20-Channel High-Voltage Relay Multiplexer	\$1,135
<b>HP 44706A</b> 60-Channel Single-Ended Relay Multiplexer	\$1,135
<b>HP 44708A</b> 20-Channel Relay Multiplexer with Thermocouple Compensation	\$1,060
<b>HP 44708H</b> 20-Channel High-Voltage Relay Multiplexer with Thermocouple Compensation	\$1,315
<b>HP 44717A</b> 10-Bridge 120 Ohm Static Strain Gage Relay Multiplexer	\$1,210
<b>HP 44718A</b> 10-Bridge 350 Ohm Static Strain Gage Relay Multiplexer	\$1,210

### FET Multiplexers

<b>HP 44709A</b> 20-Channel FET Multiplexer	\$1,035
<b>HP 44710A</b> 20-Channel FET Multiplexer with Thermocouple Compensation	\$1,140
<b>HP 44719A</b> 10-Bridge 120 Ohm Static Strain Gage FET Multiplexer	\$1,315
<b>HP 44720A</b> 10-Bridge 350 Ohm Static Strain Gage FET Multiplexer	\$1,315
<b>HP 44711A</b> 24-Channel High-Speed FET Multiplexer	\$1,095
<b>HP 44712A</b> 48-Channel High-Speed Single-Ended FET Multiplexer	\$1,265
<b>HP 44713A</b> 24-Channel High-Speed FET Multiplexer with Thermocouple Compensation	\$1,210
<b>HP 44730A</b> 4-Channel Track/Hold Multiplexer with Signal Conditioning	\$1,715
<b>HP 44732A</b> 4-Channel 120 Ohm Dynamic Strain Gage Multiplexer	\$1,920
<b>HP 44733A</b> 4-Channel 350 Ohm Dynamic Strain Gage Multiplexer	\$1,920

### Solid State Relay Multiplexer

<b>HP44705F</b> 20-Channel Solid State Multiplexer	\$1,440
<b>HP44708F</b> 20-Channel Solid State Multiplexer T/C	\$1,510

### Analog Outputs

<b>HP 44726A</b> 2-Channel Arbitrary Waveform DAC	\$2,120
<b>HP 44727A</b> 4-Channel Voltage DAC	\$1,455
<b>HP 44727B</b> 4-Channel Current DAC	\$1,455
<b>HP 44727C</b> 2-Channel Voltage; 2-Channel Current DAC	\$1,455

### Stepper Motor Controller

<b>HP 44714A</b> 3-Channel Stepper Motor Controller/Pulse Output	\$2,120
--	---------

### Counter

<b>HP 44715A</b> 5-Channel Counter/Totalizer (200 kHz)	\$1,155
--	---------

### Digital Inputs/Outputs—Switching

<b>HP 44721A</b> 16-Channel Digital Input with Totalize and Interrupt	\$820
<b>HP 44722A</b> 8-Channel AC Digital Input with Totalize and Interrupt	\$850
<b>HP 44723A</b> 32-Channel High-Speed Digital Sense/Control	\$1,110
<b>HP 44724A</b> 16-Channel Digital Output	\$810
<b>HP 44725A</b> 16-Channel General Purpose Switch	\$910
<b>HP 44728A</b> 8-Channel Relay Actuator	\$775
<b>HP 44729A</b> 8-Channel Power Controller	\$1,285
<b>HP 44788A</b> HP-IB Controller	\$710

### Breadboard

<b>HP 44736A</b> Breadboard	\$455
-----------------------------	-------

### High-Speed Accessories

<b>HP 98620B</b> 2-Channel DMA Controller for HP Series 300/200 Computers	\$530
<b>HP 98622A</b> GPIO Interface for HP Series 300/200 Computers	\$390
<b>HP 98625B</b> High-Speed HP-IB Disc Interface for HP Series 300/200 controllers	\$1,000
<b>HP 44744A</b> 2-Meter GPIO Cable with Mating for HP 44702A/B and HP 98622A	\$335
<b>HP 44744B</b> 4-Meter GPIO Cable with Mating for HP 44702A/B and HP 98622A	\$380
<b>HP 44745A</b> 4-Meter GPIO Cable with Mating for HP 44702A/B and HP 12006A (GPIO interface for HP 1000 Computers)	\$380
<b>HP44790A</b> Binary Mode Software	\$1,010

### Service and Support Products and Courses

<b>HP 44743F</b> Service Kit consists of specially designed hardware and software for operationally verifying and calibrating the HP 3852A. Fixtures for testing individual plug-in modules should be ordered separately.	\$1,810
<b>HP 50011B</b> HP-IB Course for HP Series 300/200 Computers	\$1,220
<b>HP 50015A</b> Data Acquisition and Control Fundamentals Course	\$975
<b>HP 50016E</b> HP-IB Course for HP 1000 Computers	\$1,200

# DATA ACQUISITION SYSTEMS

## Low cost, Versatile Mainframes

### HP E1300A, E1301A

- VXI, SCPI, (Industry Standards)
- Temperature, strain, voltage, resistance
- Digital I/O
- Analog Output

- General switching
- Built-in RS-232, HP-IB
- Count/Totalize

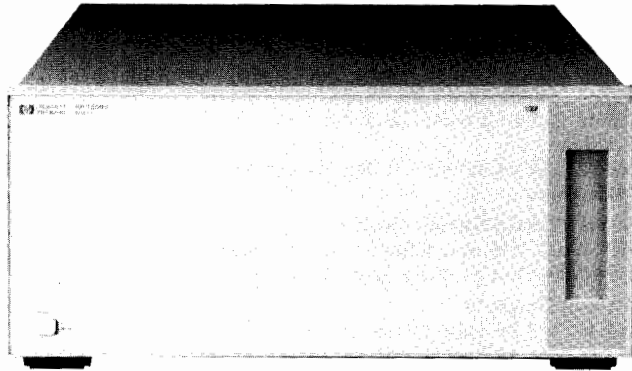

HP E1300A

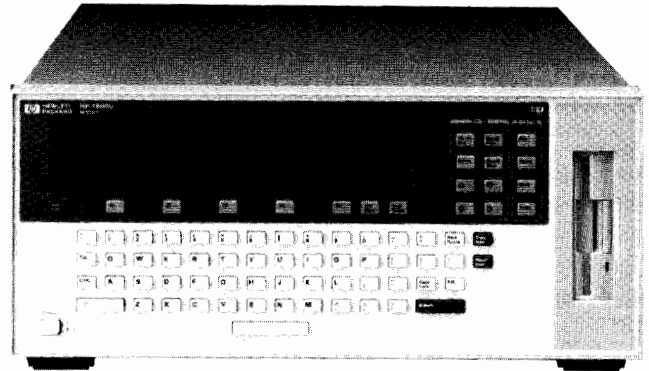

HP E1301A

### HP E1300A, E1301A VXI Mainframes

The E1300A and E1301A are low-cost but highly versatile mainframes based on VXI standards. Each mainframe provides 9 VXI B-size slots (2 internal) and 3 A-size slots. The mainframes are easily configured with a variety of plug-in cards to meet data acquisition needs.

#### Industry Standards in Data Acquisition:

VXI (VME extensions for instrumentation) and SCPI (Standard Commands for programmable Instruments) are industry standards. Utilizing Industry Standards in data acquisition helps minimize hardware and software integration efforts.

#### Optional HP IBASIC

The optional HP IBASIC has over 150 BASIC commands, which are a subset of the popular HP BASIC. The commands allow the mainframe to run user-defined programs. The user programs free the computer by performing data collection, management, and analysis within the HP 75000.

HP IBASIC allows you to:

- Reduce complex measurements to a single key stroke
- Save and print results
- Run programs as stand-alone DATA LOGGER
- Transfer results via HP-IB or RS-232
- Execute conditional branching with 'IF ... THEN ...' commands
- Control RS-232 peripherals
- Edit programs remotely via RS-232 and a terminal

#### Optional Disk Drives

When HP IBASIC is installed in the mainframe, you can add a 3-1/2 inch flexible-disk drive and/or 20 Mbyte hard disk drive. The flexible-disk drive supports 256-Kbyte, 720-Kbyte, and 1.4-Mbyte disks. In addition, both LIF and DOS formats are recognized automatically.

#### Optional RAM

Non-volatile RAM memory can be added to provide a total memory of 512 Kbytes, 1 Mbyte, or 2 Mbytes for additional reading storage.

When used with HP IBASIC, the increased RAM provides more space for programs and data. Additional RAM (512 K or more) is required for HP IBASIC.

#### Optional dc Power

The ability of the mainframe to operate on dc voltages from 10 to 30 volts affords system portability. Also, this option can be used to provide UPS capability because the switch from ac to dc operation is made automatically, without resetting, whenever the ac power stops.

#### 5 1/2-Digit Multimeter - HP E1326B

This economical, versatile multimeter meets both high-accuracy-scanning and medium-speed measurement needs in data acquisition. The HP E1326B multimeter is a two-slot B-size module that can be plugged into the back of the HP 75000 Series B mainframe or mounted in the 2 internal B size-slots.

- Dual A/Ds: 5 1/2-digit, low-noise integrating A/D and High-speed, 14 kHz 14 bit A/D
- Autozeroing and autoranging
- Directly measures dc voltage ac voltage, resistance
- Balanced differential isolated inputs
- Flexible triggering with built-in timer/pacer

#### dc Voltage

	Range	Resolution	90- Accuracy
Minimum	125 mV	120 nV	0.023% + 5 $\mu$ V
Maximum	300 V	488 $\mu$ V	0.015% + 5 mV
Resistance			
Minimum	256 $\Omega$	250 $\mu\Omega$	0.035% + 10 m $\Omega$
Maximum	1 M $\Omega$	1 $\Omega$	0.025% + 10 $\Omega$
True RMS acV			
Minimum	87.5 mV	30 nV 50 Hz - 1 kHz	0.675% + 200 $\mu$ V
Maximum	300 V	31 mV 50 Hz - 1 kHz	0.625% + 500 mV

#### Multiplexers

##### Relay Multiplexers -

##### E1345A/E1346A/E1347A/E1355A/E1356A

- Low thermal-offset reed relays (<4 microvolts, differential H-L)
- Three wires are switched per channel for voltage, 2- and 4-wire resistance (E1345A/E1347A)
- Thermocouple compensation for mixed thermocouple types (E1347A)
- Strain measurements of 1/4, 1/2, or full-bridge configurations with built-in 5 V excitation
- Break-before-make channel scanning
- Use with signals up to 170 V peak
- One-slot B-size modules

**FET Multiplexers - E1351A, E1352A, E1353A, E1357A, E1358A**

- Up to 10,000 scans per second with the HP E1326B 5 1/2-digit multimeter.
- Increased system reliability no mechanical wear out.
- One-slot B-size modules
- Maximum Voltage 16V peak, maximum current 1 mA (non-inductive)
- E1351A-16 Channel Single Ended FET Multiplexer
- E1352A-32 Channel Single Ended FET Multiplexer
- E1353A-16 Channel Thermocouple FET Multiplexer
- E1357A-8 Channel 120 ohm Strain Gage FET Multiplexer
- E1358A-8 Channel 350 ohm Strain Gage FET Multiplexer

**Counter - HP E1332A**

- Totalize, up/down count, gated totalize, pulse width, time interval, period average, and frequency measurements up to 1 GHz
- Programmable direct or isolated inputs
- Programmable digital input filter
- One-slot B-size modules

**General-Purpose Switches - HP E1364A**

- Independent Form-C relays for a wide variety of devices and signals
- Each channel has Common, Normally Open, and Normally Closed terminals for easy configuration

Maximum Input Voltage: 250 V dc or AD rms

Maximum Input Current: 1 A dc or AC rms

Maximum Input Power: 40 VA

RF and Microwave Switches - HP E1364A, E1366A, E1367A, E1368A, E1369A, E1370A

See compatible cards from the VXI B-size switch cards - beginning on page 621.

**Analog Output - HP 1328A**

- 4 isolated channels provide either dc voltage or current outputs
- Each channel works independently to maximize flexibility
- One-slot B-size modules
- Voltage range: 10.92 V
- Current range: 21.8 mA
- Settling time: 750 micro seconds
- Isolation: 120 V rms, 170 V ac/dc peak
- Programmable resolution: 333 micro volts, 667 nano amps

**Digital Inputs/Outputs - HP E1330A**

- Quad 8-bit bi-directional data ports
- One slot B size
- TTL Compatible, 5Vmax
- Digital interfacing to special-purpose circuitry or external devices
- Each block has dedicated control and handshake lines
- Supports standard GPIO protocols and different data formats such as decimal, hexadecimal, octal, and binary

**Ordering Information****HP 75000 Series B mainframes**

HP E1300A HP 75000 Series B mainframe with plain front panel \$2,300

HP E1301A HP 75000 Series B mainframe with front panel keyboard/display \$2,800

**System options installed (pick one)**

Opt 020 HP IBASIC Controller w/ 512 Kbyte nonvolatile memory +\$1,000

Opt 021 HP IBASIC Controller w/ 1 Mbyte nonvolatile memory +\$1,600

Opt 022 HPIBASIC Controller w/ 2 Mbyte nonvolatile memory +\$2,400

Opt 010 512 Kbyte nonvolatile memory +\$600

Opt 011 1 Mbyte nonvolatile memory +\$1,000

Opt 012 2 Mbyte nonvolatile memory +\$1,800

**Disk storage options installed (pick one) — requires IBASIC**

Opt 005 3-1/2 inch flexible-disk drive only +\$850

Opt 006 20-Mbyte ruggedized hard disk only +\$1,900

Opt 007 20-Mbyte ruggedized hard disk plus floppy +\$2,100

Opt 008 External dc power operation installed +\$700

Opt 009 HP E1326B 5 1/2-digit multimeter installed internally +\$1,340

**Interfaces**

HP E1324A RS-232C/422 Data Comm \$650

**Multimeters**

HP E1326B 5 1/2-digit multimeter \$1,200

**Relay multiplexers**

HP E1345A 16-channel relay multiplexer \$650

HP E1347A 16-channel thermocouple relay multiplexer \$750

HP E1346A 48-channel single-ended relay multiplexer \$800

HP E1355A 8-channel 120 Ω strain relay multiplexer \$925

HP E1356A 8-channel 350 Ω strain relay multiplexer \$925

**FET multiplexers**

HP E1351A 16-channel FET multiplexer \$875

HP E1353A 16-channel thermocouple FET multiplexer \$975

HP E1352A 32-channel single-ended FET multiplexer \$1,000

HP E1357A 8-Channel 120 Ω strain FET multiplexer \$1,125

HP E1358A 8-Channel 350 Ω strain FET multiplexer \$1,125

**Counter**

HP E1332A 4-channel counter/totalizer \$900

**General-purpose switches**

HP E1364A 16-channel form C switch \$650

**Analog Output**

HP E1328A 4-channel D/A converter \$1,100

**Digital**

HP E1330A quad 8-bit digital input/output \$600

# DATA ACQUISITION SYSTEMS

## Instruments for Measurement and Control

### HP Model 48000 RTU Family

- For Industrial Monitoring and Control
- Stand-Alone or System Operation
- Radio/Modem/Wireline Datacom

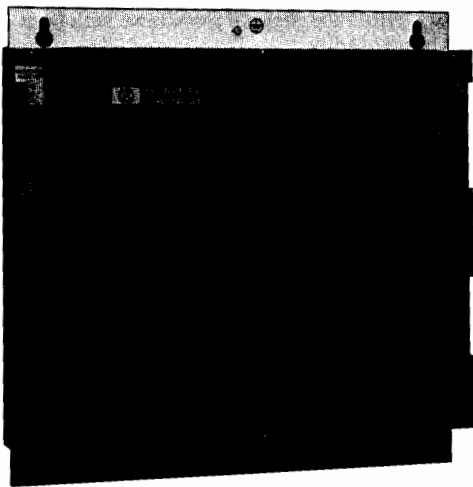

HP 48060A RTU

#### Description

The HP 48000 Remote Terminal Unit (RTU) are intelligent, microprocessor-based measurement and control units designed to operate in harsh industrial and remote environments. The HP 48000 RTU starts with 16 I/O points which can be increased to 256 I/O points with optional expansion modules.

The HP 48060A RTU is the newest member of the HP 48000 RTU product family, addressing applications that require small point counts. The HP 48060A RTU has 13 I/O points.

Applications for the HP 48000 RTU family include:

- Oil and gas production
- Pipeline SCADA systems
- Water treatment systems
- Electrical utility SCADA systems
- Facility/energy management
- Process monitoring & control

#### Built-in Intelligence

Intelligent processing is easy to implement on the HP 48000 RTU, because HP provides the right tools: built-in signal-processing functions, along with a built-in BASIC compiler. Both can be accessed through the Application Development Software, which runs on a variety of HP personal computers.

To offload host-computer processing, the HP 48000 incorporates over 50 of the most commonly required signal-processing functions. These include PID loop control, AGA flow calculations, engineering unit conversion, and alarm checking. When the database of the HP 48000 is being configured, these functions can be chained to perform multiple processing of input and output signals.

#### Easy to Program

The HP 48000 contains a built in BASIC that can be used for more complex signal processing, and for custom control routines. The BASIC is incrementally compiled, providing fast program execution in a multi-tasking environment. Up to eight BASIC tasks may reside in a single HP 48000 RTU.

The HP 48071A/72A menu-driven Application Development Software for the HP 48000 lets system designers quickly configure the RTU database to their own specifications. This software runs on the HP Vectra and the HP Portable Plus. To configure the database, the user simply selects the field on the display screen and keys in values relating to his specific application. (The database can also be configured from the HP 3081A Portable Operator Panel or a host computer.)

- Rugged Design for Harsh Environments
- Menu Driven Configuration
- Multi-Tasking BASIC

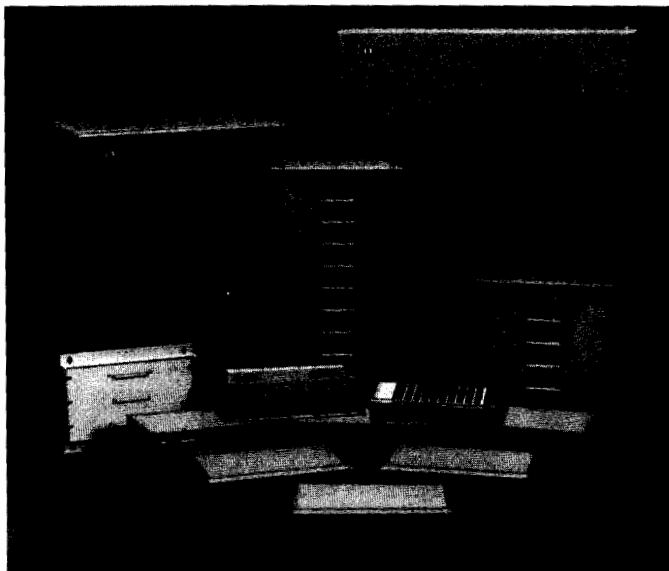

HP 48000 RTU Family

#### High Quality and Reliability

The HP 48000 RTU family is designed to withstand harsh environments. It is so rugged and reliable that a typical configuration has a Mean Time Between Failures of over five years!

Here are some features that make such performance possible.

- Use of CMOS technology contributes to the wide operating temperature specifications
- Aluminum module enclosures shield circuit boards from physical contact and ESD damage
- Transient voltage suppressors protect the electronics from electrical surges on the power line and field terminal wiring
- I/O modules are internally protected from field-wiring shorts
- Pin-and socket connectors provide reliable interconnection

#### General Specifications

**Temperature Range:** -40°C to +65°C (operating); -65°C to +85°C (storage)

**Humidity Range:** 5 to 95% non-condensing

**RFI Susceptibility:** 1 volt/meter from 14 KHz to 1 GHz

**EMI Emissions:** Meets VDE 0871 level B

**Vibration:** Random vibration 0.30 Grms 5 to 500 Hz (functional).

Random vibration 2.41 Grms 5 to 500 Hz (survival).

**Shock:** Half-sine shock pulse of <3 ms duration with 175 cm/s velocity change (functional). Trapezoidal shock pulse of 30 G with 742 cm/s velocity change (survival).

**Transient Protection:** Meets IEEE 472/ANSI-C37.90a for ability to withstand surges at all communications and field wiring points. Meets IEEE 587 standards for ability to withstand power-line surges.

**Dimensions:** 330mm W x 215mm D x 55mm H (13" x 8.5" x 2.17")

**Electrical Classification:** General Non-Hazardous Area (CSA & FM approved).

### Communications Flexibility

The diagram to the right shows some of the typical networks that can be configured with the HP 48000 RTU. Remote data acquisition and control systems are easily implemented using twisted-pair wireline, radio-communication links or telephone company facilities.

The host computer accesses data in a network of remote units in one of three modes:

- Standard poll/response
- Polled Report-By-Exception (PRBX)
- Spontaneous Report-By-Exception (SRBX)

This choice of communication modes, and the availability of both HEX ASCII and Radix-64 ASCII protocols, lets users maximize communication efficiency for their applications.

Other data communication features of the HP 48000 RTU products include:

- A Modem Module 202T or CCITT frequency
- A RS232 C port that supports smart auto-dial modems
- A FCC and DOC approved Radio Datacom Module
- A data link Repeaters to extend wireline communications
- Communication Handler software for HP host computer interface
- Multi-drop networking capabilities of up to 90 RTUs over a maximum distance of 3.6 kilometers (2.25 miles)
- The capability of communications protocol emulation

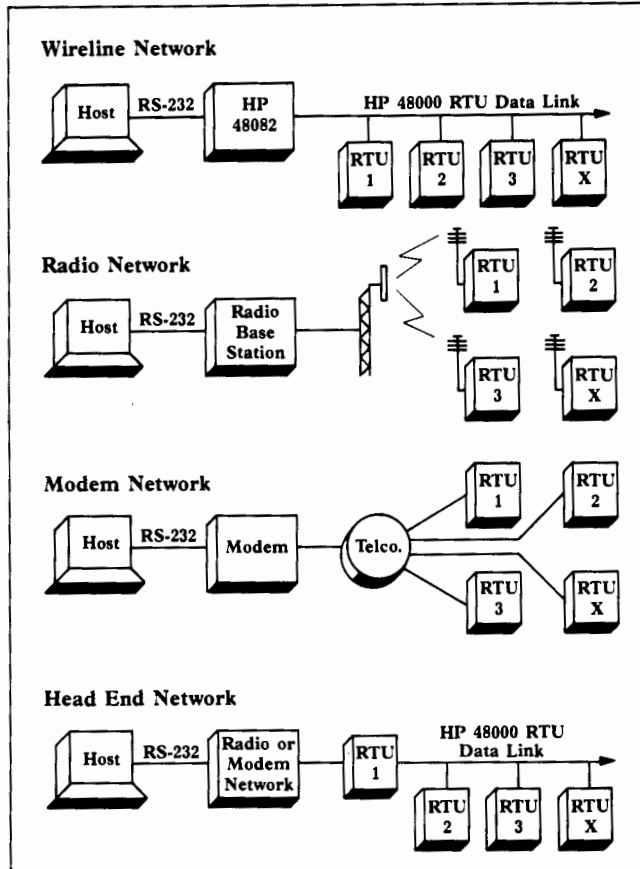

### HP 48000 RTU Ordering Information

	Price
HP 48002A 6-Slot Backplane	\$275
HP 48003A 11-Slot Backplane	\$655
HP 48004A NEMA-4 Cabinet (3/6 slot)	\$990
HP 48005A NEMA-4 Cabinet (11 slot)	\$1190
HP 48010A Master Controller Module	\$2740
HP 48020A Configurable I/O Module (16 ch)	\$1810
HP 48021A Analog Output Module (4 ch)	\$1675
HP 48022A Low Level Input (16 ch) (with thermocouple compensation)	\$3405
HP 48023A Isolated Digital Relay Output Module (8 ch)	\$1260
HP 48024A Digital Input Module (32 ch)	\$1285
HP 48025A Isolated Digital Input Module (16 ch)	\$1260
HP 48026A Isolated Digital Triac Output Module (8 ch)	\$1365
HP 48028A Digital Input/Output Module (24 ch)	\$1440
HP 48030A Power Supply Module	\$1390
HP 48041A Modem Module	\$890
HP 48085A 48000 Family Manual Set	\$480
HP 48032A Power Transformer	\$290

### Common Accessories

	Price
<b>Application Development Software</b>	
HP 48072A HP Vectra PC Version	\$255
HP 48079A User-Defined Code Development Software	\$780
HP 48082A Datacommunications Adapter	\$790

### HP 48060A RTU Ordering Information

	Price
HP 48060A Standard Unit with 13 I/O Points	\$1525
Opt 011 Adds RS-232-C/RS-422 Port	+\$395
Opt 012 Adds HP 48000 Datalink Port	+\$350
Opt 013 Adds Bell 202 Modem Port	+\$415
Opt 014 Adds Bell 212/103 Modem Port	+\$415
Opt 022 Adds 128K EPROM (max)	+\$93
HP 48004A NEMA-4 Cabinet	\$990
HP 48033A External Power Supply (+24 VDC)	\$890
HP 48086A 48060A Manual Set	\$380

### HP 48050A RTU Ordering Information

	Price
HP 48050A Standard Unit with 23 I/O Points	\$3280
Opt 001 Adds 22 ch I/O Expansion Board	+\$1050
Opt 003 Adds 18 ch I/O Expansion Board	+\$1285
Opt 011 Adds RS-232-C/RS422 Port	+\$400
Opt 012 Adds HP 48000 Datalink Port	+\$350
Opt 013 Adds Bell 202 Modem Port	+\$505
Opt 014 Adds Bell 212/103 Modem Port	+\$655
Opt 022 Adds 128K EPROM	+\$93
Opt 023 Adds 256K EPROM (max)	+\$170
HP 48004A NEMA-4 Cabinet	\$990
HP 48033A External Power Supply (+24 VDC)	\$890
HP 48086A 48050A Manual Set	\$380

# DATA ACQUISITION SYSTEMS

## Instruments for Measurement and Control

### HP 3497A

- Relay multiplexing
- DVM
- FET multiplexer
- Real time clock
- Bridge completion

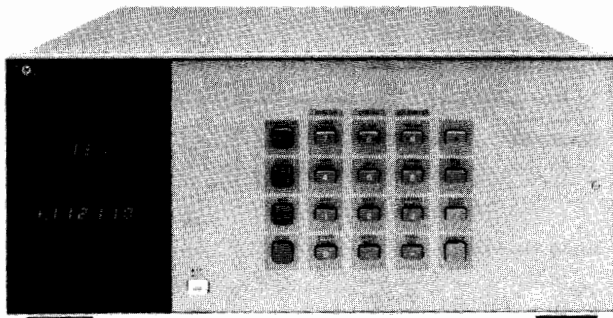

HP 3497A

### Description

The HP 3497A Data Acquisition/Control Unit combines the capabilities of several instruments and is a basic building block of an automatic data acquisition and control system. The HP 3497A will be used in an HP-IB automated system and can be viewed as a precision measurement and control computer peripheral.

The HP 3497A has been designed to be a very versatile and very powerful instrument. A basic HP 3497A consists of a mainframe that includes a front panel keyboard and display, a non-volatile real time clock, and an HP-IB interface. Available as an option is a 5½ digit integrating digital voltmeter and current source that occupies a dedicated slot in the HP 3497A chassis. Capability is added to the HP 3497A by using any combination of plug-in assemblies. Available plug-in assemblies are:

- Relay Multiplexers with or without thermocouple compensation
- FET Multiplexer
- Digital Input/Interrupt
- Counters
- Strain gage/bridge completion
- Actuators
- Programmable voltage and current D/As
- Breadboard Assembly

Up to 5 assemblies can be added to a HP 3497A and the HP 3498A Extender chassis can hold up to 10 more plug-in assemblies.

### High Performance

The HP 3497A DVM can resolve 1 microvolt signals and is ideal for the precise measurement of the outputs of thermocouples, strain gauges and other transducers. Included on the DVM is a programmable current source that allows four-terminal resistance measurements. The multiplexer assemblies switch 3 wires (Hi, Lo, and Guard) and add less than 2 microvolts of thermal offset to the measured signal.

### Flexible Hardware Configuration

The HP 3497A card cage can hold 5 of any combination of the plug-in assemblies. This allows the multiplexing of up to 100 3-wire inputs to the DVM in a single HP 3497A or a single HP 3497A might contain 60 multiplexer channels, 16 digital inputs, 16 actuator outputs, and a DVM. By using HP 3498A Extenders, up to 1000 analog channels or 1360 digital channels can be controlled, all at a single bus address.

### Ease of Use

The HP 3497A keyboard and display make the HP 3497A very easy to use and make debugging of a HP 3497A based system easy. The calibration adjustments for the HP 3497A DVM are located behind a hinged front panel; this allows complete calibration of the DVM without removing it from the test rack. Connections to all of the HP 3497A assemblies are made using screw terminals, eliminating the need for soldering.

### Real Time Clock

The HP 3497A mainframe includes a quartz-referenced, non-volatile, real-time clock. In addition to providing timing data, the clock can mea-

- Digital inputs/outputs
- Counter
- Programmable D/As
- Optional RS-232C interface

sure elapsed time, interrupt at a presettable time, and output a programmable pulse train.

### Clock Format

Month:Day:Hours:Minutes:Seconds (U.S. Format)

Day:Month:Hours:Minutes:Seconds (European Format)

### Option 001—5½ Digit DVM and Current Source

The HP 3497A DVM assembly is a systems quality, 5½ digit, 1 microvolt sensitive dc voltmeter. The DVM is fully guarded and uses an integrating A/D conversion technique; this yields excellent common and normal mode noise rejection.

Included on the DVM assembly is a three level programmable current source. The current source, when used simultaneously with the DVM, can be used to make high accuracy four terminal resistance measurements with 1 milliohm resolution. Maximum speed is 300 readings per second in 3½ digit mode.

**Buffer size:** packed format: 100 readings; ASCII format: 60 readings

Scanning Speeds	Number of Digits Selected	Series 200/300		1000A*	
		200	300	200	300
Sequential Channels using external increment	5½ digits	39	39	39 (25)	39 (25)
	4½ digits	103	103	108 (79)	108 (79)
	3½ digits	123	123	127 (99)	127 (99)
Random Channels using software	5½ digits	27	27	24 (20)	24 (20)
	4½ digits	51	51	41 (34)	41 (34)
	3½ digits	55	55	43 (36)	43 (36)

\*A600+ speeds in FORTRAN

### Option 010—20 Channel Relay Multiplexer

This assembly uses reed relays to multiplex signals to the DVM or other instruments. Each assembly switches 20 channels, each channel consists of Hi, Lo, and Guard lines. Two channels may be closed per assembly and relays may be closed in a random sequence or incremented between programmable limits. The low thermal offset of the relays make it suitable for measuring the outputs of strain gage and other transducers. Each channel can be configured with a filter or current shunt for additional flexibility.

### Option 020—Relay Multiplexer with Thermocouple Compensation

The option 020 assembly uses the same relay multiplexer as option 010 but incorporates a special isothermal connector block to allow thermocouple compensation. Two types of compensation (selectable by the user) are available. A temperature-dependent voltage is generated for software compensation; this voltage is then used in a computer program to compensate the thermocouple voltage. Hardware compensation involves inserting a voltage in the measurement circuit that automatically compensates the thermocouple voltage.

### Option 030—20 Channel FET Multiplexer Assembly

The option 030 assembly is used to multiplex input signals to a DVM in a manner similar to option 010. The option 030 assembly provides high speed, low level multiplexing. Maximum signal levels are 12 volts peak between any high, low or guard input and any other guard input, guard common or chassis ground.

**Maximum sequential scanning rate:** 4800 readings/s (at 60 Hz) using an HP 3437A Voltmeter and HP Series 200 computer (4000 readings/s at 50 Hz power).

### Option 050—16 Channel Isolated Digital Input/Interrupt

The option 050 assembly can sense up to 16 channels of digital data. The first 8 channels can also be used as interrupt lines to detect transient signals. The assembly can accept inputs of 5, 12 or 24 volts and all functions and masks are fully programmable. A five-volt supply is provided for driving external contact closures and open collector outputs.

**Option 060—100 kHz Reciprocal Counter**

This option can be used to measure mechanical and low frequency electronic signals. The counter can measure the period of signals up to 100 kHz and the pulse width of signals down to 18  $\mu$ s. The counter can also count up or down from a programmable start point. It can accept inputs of 5, 12, or 24 volts including CMOS, open collector TTL and passive contact closures.

**Option 070—120 Ohm Strain Gage/Bridge Completion Assembly****Option 071—350 Ohm Strain Gage/Bridge Completion Assembly**

The option 070/071 assemblies may be used to provide bridge completion for measuring strain gages, RTDs pressure sensors and load cells. Each card uses an internal shared half bridge and can complete 10 channels of  $\frac{1}{4}$  and  $\frac{1}{2}$  and full bridges in any combination. When used with a +5 V excitation supply (such as the HP 6214A) and the HP 3497A DVM, the assembly provides 0.1  $\mu$ e sensitivity with 1  $\mu$ e accuracy. Provisions are made for shunt calibration and checking gage leakage and lead resistance.

**Option 110—16 Channel Actuator****Option 115—8 Channel High Voltage Actuator**

Option 110 consists of 16 mercury wetted form C (single pole-double throw) relays. Each relay can be individually closed and can switch 1A at 100V. The actuator assembly can be used to switch test fixture power or to actuate alarm bells. This flexibility of this assembly allows it to be used as a digital output or matrix switch.

Option 115 is an 8 channel high voltage actuator assembly that can switch voltages up to 252 Vrms and currents up to 2 amperes. The Option 115 assembly is ideal for switching power line voltages to small motors, alarm bells and lights, motor starters and solenoids.

	Option 110	Option 115
Switch Form	C	A
Contact Type	Mercury Wetted	Dry
Number of channels	16	8
Maximum Voltage	100 V Peak	252 Vrms 48 Vdc
Maximum Current	1 A	2 Arms or dc
Maximum Power	100 VA	500 VA ac 60 VA dc

**Option 120—Dual Voltage D/A****Option 130—Dual Current D/A**

Option 120 consists of two 0 to  $\pm 10$  V programmable voltage sources. These sources can be used to provide a programmable test stimulus or to control voltage programmed devices like power supplies and VCOs.

Option 130 consists of two 0 to 20 mA or 4 to 20 mA programmable current sources. These sources, especially when using the 4 to 20 mA range, can be used as transmitters in industrial current loops and can drive up to 600 ohms of total loop resistance.

**Option 120**

**Output:** 13 bits including polarity

**Least significant bit:** 2.5 mV

**Output range:** -10.2375 V to +10.2375 V

**Maximum output current:** 15 mA (output within specifications)

**Option 130**

**Output:** 12 bits

**Least significant bit:** 5  $\mu$ A (0 to 20 mA range)  
4  $\mu$ A (4 to 20 mA range)

**Output range:** 0 to 20.475 mA or 4 to 20.380 mA (each source jumper selectable)

**Compliance voltage:** 12.0 volts

**Option 140 Breadboard Card**

Option 140 is a breadboard card compatible with the HP 3497A cardage. Using this card, HP 3497A users can construct special purpose assemblies that communicate with the HP 3497A backplane.

**Option 232—RS232C Interface**

Option 232 to the HP 3497A deletes the standard HP-IB interface and adds an RS232C (CCITT/V.24) compatible interface allowing you to remotely program the HP 3497A. The option 232 interface is also compatible with the new RS423 (CCITT/V.10) version of the RS449 interface.

**Option 298—HP 3498A Extender**

The HP 3498A Extender chassis allows low cost expansion of HP 3497A-based systems. Each HP 3498A can hold up to ten HP 3497A

plug-in assemblies. Use of one or more HP 3498As requires an HP 3497A (for control); all required connecting cables are supplied with the HP 3498A. Up to 13 HP 3498As can be controlled by a single HP 3497A.

**Software**

**HP DACQ/PC Data Acquisition Manager (HP 44459A/B/R):** Powerful software tools for gathering, storing, analyzing, and presenting measurement data with a Vectra Personal Computer and the BASIC language processor. (see page 600).

**HP DACQ/300 Data Acquisition Manager (HP 44458A/B/R):** Sophisticated software tools that provide all of the power of HP DACQ/PC plus enhanced data transfer, system configuration routines, and color graphics on Series 300 Technical Computers (see page 600).

**General**

**Size (HP 3497A or HP 3498A):** 190.5 mm H x 428.6 mm W x 520.7 mm D (7 $\frac{1}{2}$ " x 16 $\frac{7}{8}$ " x 20 $\frac{1}{2}$ ").

**Net weight:** HP 3497A, 20.4 kg (45 lb) and 3498A, 20.4 kg (45 lb) with assemblies in all slots.

**Shipping weight:** HP 3497A and HP 3498A maximum with assemblies in all slots are 26.3 kg (58 lb.)

Operating temperature: 0°C to 55°C

Non-operating temperature: -40°C to 75°C

Humidity: to 95% at 40°C except as noted

Operating power: switch selection of 110, 120, 220 and 240 volts  $\pm 10\%$ , 48-66 Hz, 150 VA 3497A and 3498A.

**Ordering Information****Price**

Each HP 3497A can hold one DVM assembly (Opt 001) and up to 5 plug-in assemblies. Each HP 3498A (Opt 298) can hold 10 additional plug-ins. To order plug-ins without a mainframe, order as 444XXX Field Installation Kits as shown below.

Clock format and power line frequency and voltage will be set at the factory based on the country from which the order was placed.

<b>HP 3497A Data Acquisition/Control Unit</b>	<b>\$3,890</b>
<b>Opt 001 or 44420A:</b> 5 $\frac{1}{2}$ Digit DVM and Current Source	\$2,020
<b>Opt 010 or 44421A:</b> 20 Channel Relay Multiplexer Assembly	\$830
<b>Opt x20 or 44422x:</b> Relay Multiplexer Assembly Substitute A in place of x for software compensation. For hardware compensation, substitute the thermocouple type B, E, J, K, R, S, or T for x.	\$950
<b>Opt 030 or 44423A:</b> 20 channel FET Multiplexer Assembly	\$950
<b>Opt 050 or 44425A:</b> 16 channel Isolated Digital Input/Interrupt Assembly	\$705
<b>Opt 060 or 44426A:</b> 100 kHz Reciprocal Counter	\$810
<b>Opt 070 or 44427A:</b> 120 Ohm Strain Gage/Bridge Completion Assembly	\$1,160
<b>Opt 071 or 44427B:</b> 350 Ohm Strain Gage/Bridge Completion Assembly	\$1,160
<b>Opt 110 or 44428A:</b> 16 Channel Actuator/Digital Output Assembly	\$950
<b>Opt 115 or 44431A:</b> 8 Channel High Voltage Actuator Assembly	\$810
<b>Opt 120 or 44429A:</b> Dual Output Voltage DAC Assembly	\$1,300
<b>Opt 130 or 44430A:</b> Dual Output Current DAC Assembly	\$1,300
<b>Opt 140 or 44432A:</b> Breadboard Card	\$215
<b>Opt 232:</b> Delete HP-IB Interface, add RS232C Interface	\$405
<b>HP 3498A Extender &amp; Connecting Cables</b>	<b>\$2,880</b>

# DATA ACQUISITION SYSTEMS

## Software Solutions

Data Acquisition Manager - DACQ/300 and DACQ/PC, DACQ/UX, HP 44458A, 44459A, 44460A

- Reduce your software development time
- Customize your data management needs
- Optimize your software performance

- Use with the controller of your choice: either HP 9000 Series 200/300, HP Vectra PC, HP-UX Workstation
- Use with any HP-IB instrument

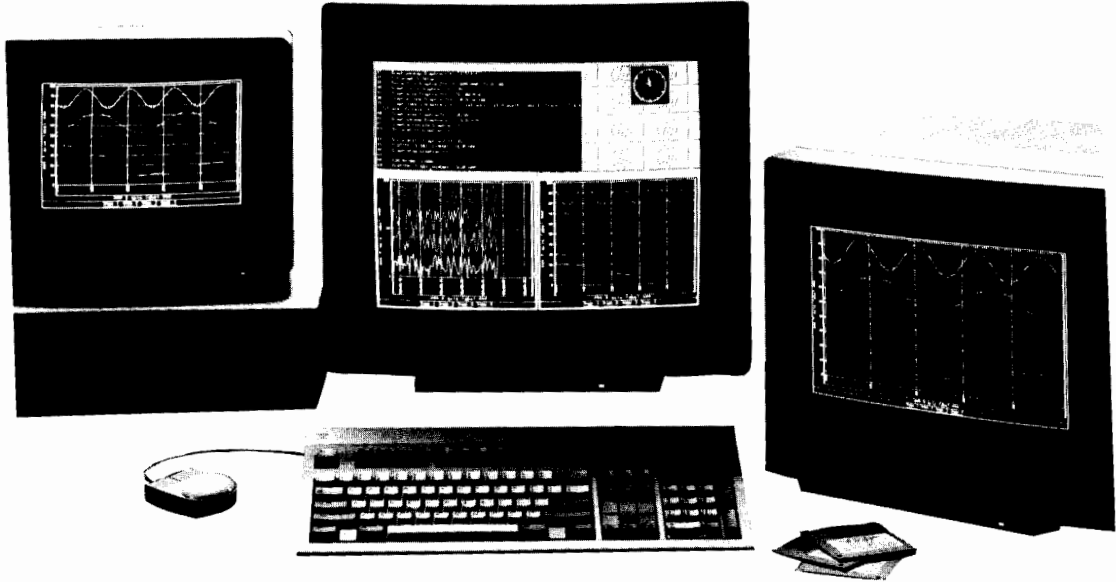

### Description

HP Data Acquisition Manager is a general-purpose subroutine library for the HP 9000 Series 200/300 controllers (HP DACQ/300), HP-UX Workstation, or the HP Vectra Personal Computer equipped with the HP BASIC language processor (HP DACQ/PC). The software reduces your development time by providing you with software tools (subroutines written in HP BASIC and compiled Pascal) that you can add to your HP BASIC program to handle up to 90% of your data management functions. Customize your data management programs by adding these subroutines to match your final application needs. Optimize your software performance through HP Data Acquisition Manager's compiled subroutines and use of memory volumes (electronic disc). Eliminate the need to have several software packages because HP Data Acquisition Manager provides you with subroutines that cover a wide range of data acquisition and control tasks and works with any HP-IB instrument. Use HP Data Acquisition Manager with the controller of your choice - either the HP 9000 Series 200/300 controller or the HP Vectra Personal Computer. Both controllers offer you the HP BASIC language (on the HP Vectra PC through use of the HP BASIC Language Processor - HP 82300B) for one of the most powerful and easy-to-use programming environments available for instrument control.

### Data Management

Use HP Data Acquisition Manager to:

- Set up a data base organized into archives, books and pages
- Specify the format of books and pages
- Collect data over HP-IB, GPIO, from the program, or the keyboard
- Time-stamp and store the data into the data base
- Document the data
- Retrieve the data from the data base to display, analyze or transmit it elsewhere

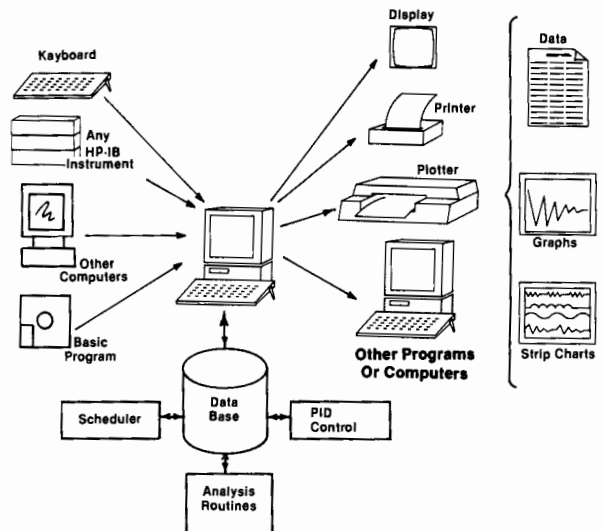

### Data Analysis

Entire arrays of data captured over HP-IB or retrieved from the data base can be analyzed quickly using the data analysis subroutines. Analysis functions available are:

- Scaling ( $mx+b$ )
- Limit checking
- Statistics (high, low, mean, standard deviation)
- Math (+, -, \*, /)
- FFT and inverse FFT
- Temperature conversions (thermocouples, thermistors, RTDs)
- Strain gage conversions
- User-defined look-up tables
- Unpacking packed HP 3852 high speed voltmeter readings



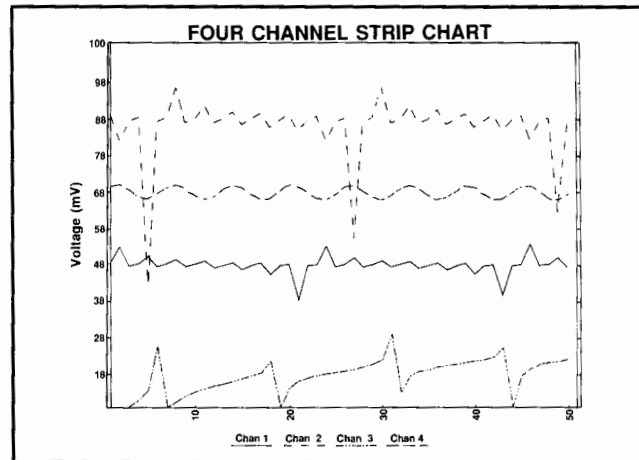
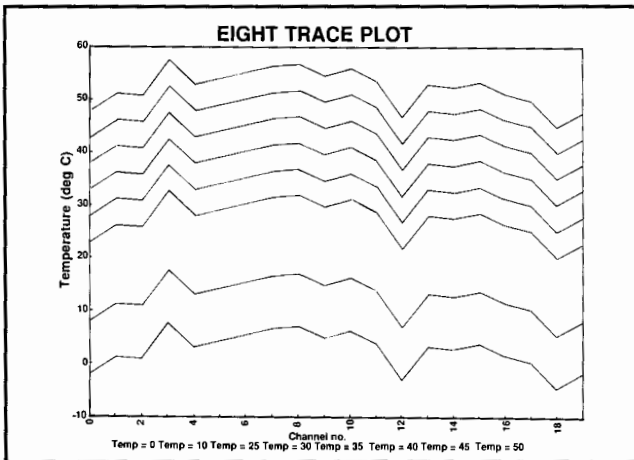

### Data Presentation Printing

Captured data and sections of the data base can be formatted and printed on the controller display or to a supported printer.

### Plotting

Plot subroutines allow you to plot up to eight traces per chart on either the controller display or an HP plotter. Labels, size, location, color (HP DACQ/300 only), and orientation of the chart are programmable, allowing you to have more than one chart per screen or page. Linear and logarithmic scaling (with or without grid lines) are available as well as auto-scaling of the entire chart.

### Real-time Stripcharting

The stripchart subroutines allow you to plot up to four traces on the controller display as the readings are being received from the instrument. Once the screen is full, the data scrolls on the display from right to left. A file can be reserved to store values that scroll off the display. Data from the instrument can be plotted versus time or a user-defined array. If a hard copy of the stripchart is desired, the data can be saved and later sent to an HP plotter with the plot subroutines.

### Data Transmission

Transmit data from the data base to another computer over RS-232, using the data transmission subroutines. These subroutines can be used to set up the HP 9000 Series 200/300 Datacomm Card (HP 98628A) with the desired protocols. The ENQ/ACK and X-ON/X-OFF protocols, baud rate, handshaking, and the use of modems are all supported with these subroutines. Files of data can be transmitted using a default ASCII format or you can create your own format. When the default format is used, the files transferred can be used by Lotus 1-2-3™ or Wordstar™. The transferred ASCII file can also be transmitted to other computers using the HP Vectra PC Advance-Link software.

### Process Control

Calculate up to 10 PID algorithms with one HP Data Acquisition Manager subroutine call. You specify the PID constants and send the measured values from your process to the subroutine. The subroutine performs the PID calculation and returns the final values. Bumpless control allows a smooth transition from manual to automatic control of your process using the PID subroutines. You can cascade two or more of the PID loops and adjust the PID constants (tune your process control loops) while the process is still under automatic control.

### Task Scheduling

The scheduler subroutine assists you in scheduling tasks (in the form of subroutines) within your program. The software creates a table of up to 99 tasks and allows you to designate each task name and number, starting time, time interval between task runs, number of times the task is to be run and its priority. When the scheduler subroutine is called, it returns the number of the task with the highest priority scheduled for that time. Your program can then run that task by calling the appropriate subroutine.

### Configuration/Verification (HP DACQ/300)

The HP 9000 Series 200/300 version of HP Data Acquisition Manager (HP DACQ/300) also contains a menu-driven program that you can use to help document your equipment set-up and application. The program allows you to write a description of your application and prompts you to list the peripherals and instruments attached.

The program automatically reads the configuration (processor, memory, plug-in interface cards, operating system) of the HP 9000 Series 200/300 controller and an HP3852 data acquisition unit (if present). When you are finished, the entire setup and description will be saved in a file. The program even contains a routine to verify that the present configuration matches a configuration stored in a file.

### Summary

HP Data Acquisition Manager is a powerful software package that provides you with tools to handle up to 90% of your data acquisition/control program. This leaves you time to concentrate on other aspects of your application. Collecting, storing, analyzing, transmitting, and scheduling data collection and subroutines are all handled by this software. Add only the routines that you need to customize your program and allow HP Data Acquisition Manager to optimize your software performance. Use this software with any HP-IB instrument on the controller of your choice, either the HP 9000 Series 200/300 or the HP Vectra PC, with the HP BASIC language processor, for virtually all of your data acquisition data management needs.

### Supported Computers

#### HP BASIC and HP-UX Workstations:

Series 300 Model 370  
Series 300 Model 360  
Series 300 Model 350  
Series 300 Model 340  
Series 300 Model 332  
Series 300 Model 330  
Series 300 Model 320  
Series 300 Model 319  
Series 300 Model 310  
Series 300 Model 236 (B/W only)  
Series 300 Model 220  
Series 300 Model 217  
Series 300 Model 216

#### Operating System for HP DACQ/300 and HP DACQ/UX

HP BASIC 5.0 or greater for the HP BASIC workstations  
HP BASIC/UX 5.52 with HP-UX 7.0 for the HP-UX workstations  
Basic Language Processor for HP DACQ/PC - BASIC emulators:  
A.xx.xx, B.xx.xx, and C.xx.xx

#### Memory

1.5 Mbyte or greater

#### Ordering Information

	Price
HP 44458A HP DACQ/300 software and manual, 3 1/2" and 5 1/4" disks	\$2,055
HP 44458R HP DACQ/300 manual and license to copy HP DACQ/300 software (HP 44458A or HP 44458B) for use on one other computer	\$1,255
HP 44459A HP DACQ/PC software and manual, 3 1/2" and 5 1/4" disks, required HP 82300C Basic Language Processor	\$1,530
HP 44459R HP DACQ/PC manual and license to copy HP DACQ/PC software (HP 44459A or 44459B) for use on other computer	\$955
HP 44460A HP DACQ/UX software and manual, 1/4" tape	\$2,050
HP 44460R HP DACQ/UX manual and license to copy HP DACQ/UX software (HP 44460A) for use on one other computer	\$1,250

# COMPUTER AIDED TEST

## Measurement Systems Architecture

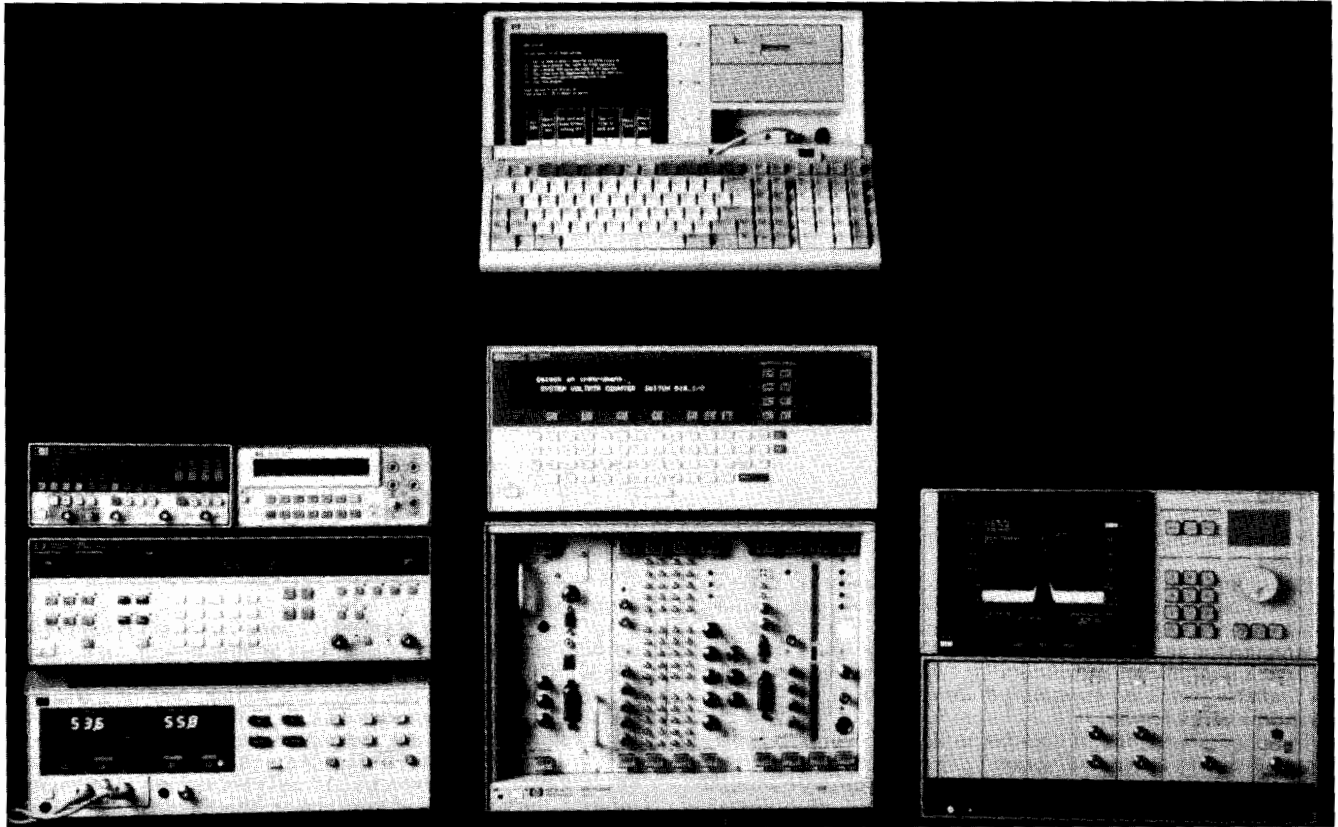

HP stand-alone, VXIbus, and modular measurement system products, along with controllers and software, are all part of the HP Measurement Systems Architecture

### The Measurement Systems Architecture for the '90s

Keeping pace with today's complex, changing measurement needs requires a new approach to automated testing—one that will minimize the time, effort, and risk involved in system design.

Hewlett-Packard meets this challenge with the measurement systems architecture for today and the future. The HP Measurement Systems Architecture is industry's widest, most advanced selection of hardware, software, controller, and support offerings. Products are based on industry standards for greater compatibility. Using this approach you can create cost-effective systems that cover applications from dc to lightwave.

Within the HP Measurement Systems Architecture, new modular product families enhance our traditional HP-IB test equipment. All have measurement functions optimized for automated testing.

### The HP 70000 modular measurement system

The HP 70000 modular measurement system (MMS) offers rugged, reliable instrumentation for applications from RF through lightwave. For 1990, we have introduced a powerful new color display/mainframe and a host of new modules.

### The HP 75000 VXIbus system

The HP 75000 VXIbus system is part of this emerging technology with particular strengths in digital and analog measurement. Our B- and C-sized mainframes and modules share a common human interface and common set of instrument commands.

### HP-IB

HP-IB products offer the largest hardware selection for system integrators. New 'smart' HP-IB instruments feature built-in controllers for greater system efficiency. HP-IB is HP's implementation of the IEEE-488 standard.

### Controllers

HP controllers include the HP Vectra personal computer and popular HP 9000 technical computers. Rackmount models are compact and easy to integrate into test systems.

### Standard Commands for Programmable Instruments

SCPI is the name of the new, industry standard that is based on TMSL, HP's Test and Measurement Systems Language. SCPI is a universal set of instrument commands that HP has already implemented into its VXI products and many stand-alone and modular measurement system (MMS) products.

### System Support

Your investment in HP products, including those in MSA, is protected by our commitment to long-term system support. Our sales and support people have the expertise you need to help put your system together and keep it running smoothly. HP products are backed by excellent warranties and service. And our many training courses help you get the most out of your HP purchase.

### Measurement Systems Architecture

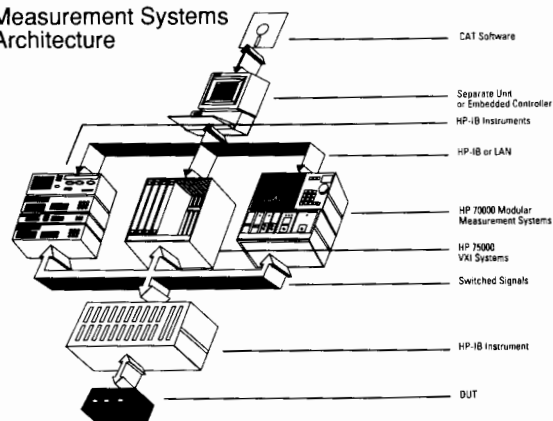

### Modular, Open Systems Maximize Your Flexibility

Modularity answers a number of critical issues for the automated-test-system designer. Rack and floor space are saved. There is less duplication of measurement functions. Systems can be reconfigured easily by exchanging modules. HP has taken a leading role in helping establish both the VXIbus and the modular measurement system as fully open, modular standards into which any manufacturer can build.

#### VXIbus system

The flexible addressing system of the VXIbus system makes the best use of module space within the mainframe. Multiple instruments can be located on one module or card, or one instrument can span more than one slot. Local bus lines allow fast, private communication between a set of cards performing a specific measurement function. The HP 75000 Series C mainframe delivers high performance while allowing for system downsizing. Modules include a command module, digital multimeters, multiplexers, a function generator, and more. The HP 75000 Series B mainframe is designed for low-cost computer-aided-test applications, and the modules include a digital multimeter, relay multiplexers, counters, a digital/analog converter, and more. For descriptions of HP 75000 series products, see page 621.

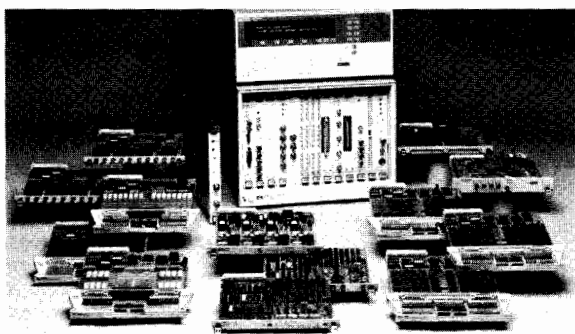

HP 75000 VXIbus mainframes and modules

#### Modular measurement system

For test systems that require high performance microwave functionality, the HP 70000 modular measurement system provides the needed environment. Mechanical structures are optimized for holding heavy microwave components. Mainframes and modules are designed for the electromagnetic compatibility critical to sensitive high-frequency equipment. Systems are configured and reconfigured easily with interchangeable modules.

The ability to share power supplies and a single display contribute to the system's overall efficiency. A powerful digital backplane provides fast module-to-module communication. A new color display/mainframe turns your MMS into a microwave workstation, and new modules add vector voltmeter, power meter, signal generator, scalar measurement, and other capabilities. See pages 189 and 336.

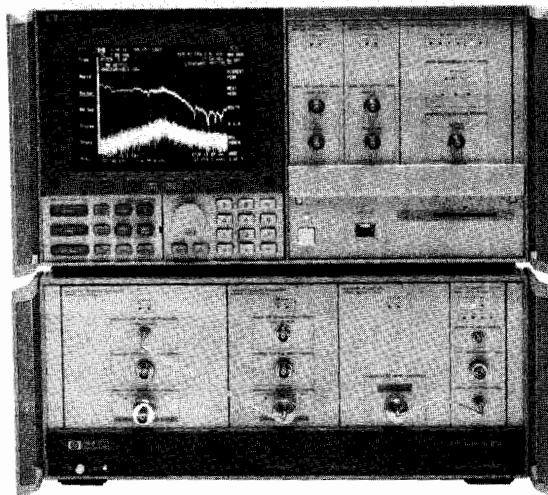

The HP 70000 modular measurement system

#### Stand-alone instruments

Compatible stand-alone instruments make the HP Measurement Systems Architecture the largest selection in the industry. These products are listed throughout the catalog, indicated by the HP-IB symbol. General information on HP-IB is found on page 574.

#### Time-saving Hardware and Software Development Tools

The HP 70000 modular measurement system and HP 75000 VXIbus families offer test equipment and development tools for every step in the design and integration of today's automated test systems. Choose from a wide array of modules and mainframes. Part kits along with design guides and schematics are also available for creating your own VXIbus and modular measurement system products.

#### HP BASIC

To make software development easier, the powerful HP BASIC has been optimized for instrument control and is available on UNIX® and MS-DOS® operating systems. This popular programming language runs on a wide range of HP computers and workstations. When system rack space is at a premium, you will find HP controllers in rackmount or VXIbus configuration. Details about HP controllers begin on page 604.

#### Development software

In addition, the HP Interactive Test Generator software accelerates the development of HP BASIC test programs using a windowed, mouse-driven interface designed for generating code and controlling IEEE-488 instruments. The HP Functional Test Manager software gives you a reusable framework for customizing production test systems. Features include standard forms for a uniform approach to test development; flexible, user-written subroutines that are easily integrated into test programs; statistical quality control (SQC) and database management; and more. See pages 610 and 612, respectively.

#### Industry standard command language

SCPI provides a universal set of commands for instruments. Common commands simplify software development because you no longer need to learn a different programming language for every instrument in your system. Using a common instrument language minimizes software modifications when upgrading your system hardware.

SCPI is based on HP's TMSL. SCPI is implemented into all of HP's VXI products and many stand-alone products already. HP plans to implement SCPI into all new systems products and retrofit some existing products, including the MMS products.

UNIX® is a registered trademark of AT&T in the U.S.A. and other countries.  
MS-DOS® is a U.S. registered trademark of Microsoft Corporation.

# COMPUTER AIDED TEST Instrument Controllers

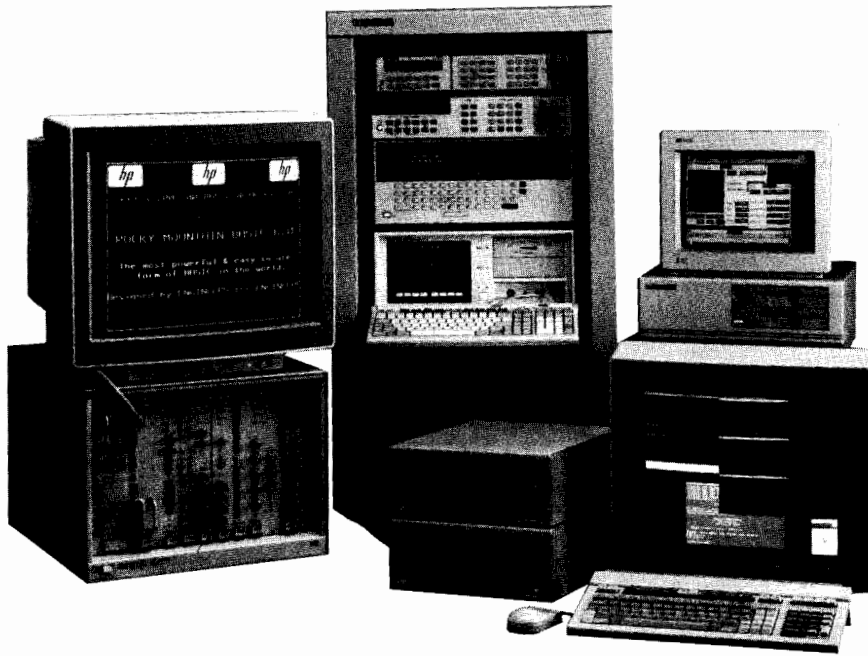

## Introduction

Hewlett-Packard has for many years been a leading supplier of instrument control solutions for data acquisition and electronic test.

In the early 1970's, Hewlett-Packard developed the HP-IB interface, also known as IEEE-488 or GP-IB, to provide a standard bus for instruments and peripherals. Since then, this interface has become the standard way for communication with instruments in the test and measurement community. With over seventeen years of experience in providing instrument controllers, Hewlett-Packard has optimized these systems to work with over 1500 HP instruments and peripherals through HP-IB.

Hewlett-Packard is also incorporating emerging standards into instrument controllers. Hewlett-Packard has been instrumental in driving the VXIbus standard for development of instruments-on-a-card (see page 621). This standard addresses the need to down-size test systems while providing the performance and flexibility required for advanced test systems. The HP V/360 instrument controller answers the need for a high-performance instrument controller embedded within the VXI mainframe.

Hewlett-Packard is extending the usability of the HP-IB by driving the definition of the IEEE 488.2 standard. The new Standard Commands for Programmable Instruments (SCPI), which fully supports IEEE 488.2, is based on HP's Test and Measurement Systems Language (TMSL). SCPI is a command language that supports all instrument types. Instruments that are SCPI-compatible are easier to program than other instruments, and test systems that contain SCPI instruments can be upgraded without requiring new software to be written. HP has implemented SCPI in over 30 instruments already and plans to implement it in all new systems instruments.

HP instrument controllers, instruments, and software make it easy to build custom test systems for unattended testing in R&D,

or for manufacturing test and quality control applications. Software packages such as the Interactive Test Generator (see page 610), Functional Test Manager (see page 612), DACQ/300 and DACQ/PC (see page 613) take full advantage of HP instrument controller features to aid in the development and execution of computer-aided test and data acquisition applications.

## Wide Range of Controllers

Hewlett-Packard offers the widest range of instrument controllers in the industry. Each controller system is optimized to meet the needs of test and measurement customers.

Controller solutions are available for price-sensitive users and for applications requiring the highest performance and technology. You have the choice of operating system, computer hardware platform, and form factor that best meets your test system requirements.

Hewlett-Packard offers instrument controllers based on MS-DOS and HP-UX, two industry-standard operating systems, in addition to HP BASIC, the world's most powerful instrument control environment.

## DOS Controllers

For low-cost instrument control, HP also offers controller solutions that provide the advantages of native DOS. A variety of HP Vectra personal computers (see page 682) are available in a variety of price and performance ranges to fit your requirements.

The HP-IB interface and command library (see page 606) helps you use PCs to perform sophisticated instrument control, and it supports a variety of standard MS-DOS programming languages.

## HP-UX Controllers

Hewlett-Packard's HP-UX is a complete UNIX System V implementation with selected enhancements to provide features necessary for the test and measurement environment. A number of programming

languages are available for the development of instrument control applications. Powerful networking and database tools are available within HP-UX.

The Device I/O Library (DIL) enhances HP-UX for instrument control applications. DIL allows HP-UX systems to provide very high-performance instrument control. DIL directly supports DMA hardware and burst-mode I/O. Interrupt response time is minimized in a number of ways. Real-time extensions allow you to specify which programs must run with special priority.

## HP BASIC Controllers

Hewlett-Packard controllers used with the HP BASIC language offer a highly productive environment for developing and executing test and measurement applications.

The HP BASIC programming environment is unsurpassed in ease of use and user friendliness. As you type in code, an advanced program editor checks it for syntax errors.

Advanced commands for moving and copying program lines are fully integrated into HP BASIC, along with other features useful in producing very readable, self-documenting programs. Automatic program indentation, string search and replacement, and automatic renumbering of program lines are standard with HP BASIC.

HP BASIC controllers provide ready access to the most advanced device I/O systems available. Full interrupt processing is supported with fifteen levels of user-definable software priorities. Data transfer of various data types is also fully supported. Data formatting is handled automatically for REAL, INTEGER, STRING, and COMPLEX data and for arrays of these data types.

The HP BASIC I/O system automatically determines the optimal data transfer method based on system configuration. For example, data transfer automatically takes full advantage of Direct Memory Access when DMA hardware is present in the system; no programming changes are required to take advantage of DMA hardware.

Support of separate context subprograms within HP BASIC allows you to develop modular, reusable program segments to be loaded or unloaded during program execution. This increases productivity because modules are easily reused or replaced with new ones for future controller applications.

HP BASIC provides the capability of using compiled subprograms, or CSUBS, developed with standard language compilers. These CSUBS provide increased performance for many applications while still operating within HP BASIC. An HP BASIC compiler is also available to increase performance of HP BASIC programs without having to develop non-BASIC code.

HP BASIC is available on three platforms:

- HP BASIC/DOS for use on personal computers.
- HP BASIC/UX for use with HP-UX workstations.
- HP BASIC/WS for high-performance operation as a dedicated controller.



### HP 9000 Series 300 Controllers

The HP BASIC/WS and HP BASIC/UX systems are based on the HP 9000 Series 300 controller systems. The HP BASIC/WS system incorporates its own operating system with the HP BASIC environment and is highly optimized to provide the best performance platform. The HP BASIC/UX systems are based on the standard HP-UX operating system on the same series 300 hardware platform and provide the additional benefits associated with multi-tasking/multi-user operating systems, including an X windows-based environment and access to HP-UX tools and applications.

The HP 9000 Series 300 instrument controllers are available in a variety of configurations with a wide range of performance. The latest offerings take full advantage of Motorola MC68030 microprocessors. Both HP BASIC/WS and HP BASIC/UX operating systems are supported for use with series 300 controller systems. HP BASIC/UX can be added to series 300 HP-UX systems to provide the best of the HP-UX and HP BASIC worlds.

The model 340 is the lowest cost series 300. It provides good performance in a restricted configuration. It comes standard with 4 Mbyte RAM, HP-IB, HP-HIL, LAN, and RS-232 interfaces and a Motorola

MC68882 math coprocessor. One additional DIO I/O slot is available for the addition of SCSI, Fast Disk or other series 300 I/O cards. RAM can be expanded to a total of 16 Mbyte, but no additional I/O slots can be added to the system.

The model 332 controller provides the same performance as the model 340, while offering the ability to add a variety of series 300 interface cards. The model 332 comes standard with 1 or 4 Mbyte RAM and can be expanded to 8 Mbyte. This controller also comes standard with HP-IB, HP-HIL, RS-232, and either medium- or high-resolution displays. Two DIO I/O interface slots are available for additional interfaces such as LAN, SCSI or fast disk interfaces, and one optional expander (4 DIO I/O interface slot pairs) can be added to increase I/O capability. The optional Motorola MC68882 math coprocessor increases floating point math, and it is required for either HP-UX or HP BASIC/UX operation.

The model 332 is also available in a standard EIA 19" rack-mountable configuration (see page 609). The Series 300 Model R/332 provides the same performance as the modular model 332 system in a fully integrated, rack-mountable package. The 7-inch high package is ideal in applications where space is at a premium, since it integrates a 9"

medium-resolution display, hinged keyboard, flexible-disk drives, and optional 20 or 40 Mbyte disk drives. As with the model 332, RAM can be expanded on the R/332 to up to 8 Mbytes, but it provides better I/O expansion capabilities by offering 4 DIO I/O slot pairs in its backplane.

The model 360 and model 375 are also expandable configurations. Both systems include LAN, HP-IB, HP-HIL, RS-232, MC68882 math coprocessor and optional fast disk or SCSI interfaces. The model 360 comes standard with a 25 MHz Motorola MC68030 processor and 4 Mbyte RAM and can be expanded to a total of 16 Mbyte. The model 375 comes standard with 50 MHz Motorola MC68030 processor and 8 Mbytes of error correcting and checking (ECC) RAM. RAM can be expanded to a total of 32 Mbytes. If 4 Mbyte RAM chips are used, the model 375 can be expanded to 128 Mbytes of RAM. For additional performance, the model 375 is available with a 25 MHz Motorola MC68040 microprocessor upgrade.

Both the model 360 and 375 provide the computational power for test and measurement applications requiring the highest performance. The model 360 is also available as an embedded VXI controller. This controller provides the same performance as the Model 360, but has been repackaged and enhanced to fit in a Series C VXI mainframe, giving full access to the VXIbus structures and providing Slot0 functionality. The V/360 includes the same HP-IB, HP-HIL, RS-232, LAN and either SCSI or fast disk interface as the modular model 360 above, but no additional I/O cards can be added. RAM is 4 Mbytes standard and may be expanded to 16 Mbytes. A choice of five graphics subsystems is available.

### PC-300 Controllers

HP BASIC/DOS controllers combine HP Vectra personal computers with the HP 82300C Measurement Coprocessor. The HP 82300C runs HP BASIC and is compatible with other HP BASIC systems.

The HP Vectra PC platforms cover a wide performance spectrum. The entry-level PC-308 controllers are based on the HP Vectra 286/12 PC. There are three PC-308s, giving display options and hard disk capacity options.

The PC-312CL controller is based on the HP Vectra QS/16S PC, which uses the 80386SX processor. The PC-312CM platform is the Vectra QS/20 20 MHz PC using the 82386 processor.

The PC-315CN has the highest performance and is based on the Vectra RS/25C.

Each PC-300 comes standard with display, hard disk, 3.5" flexible-disk drive, a serial/parallel card, and the installed HP 82300C installed.

The HP 82300C has a built-in HP-IB port and 1 Mbyte of on-board RAM (expandable to 4 Mbytes.) HP BASIC comes with all PC-300s for installation on the HP 82300C.

HP BASIC can run in background on the HP 82300C simultaneously with MS-DOS applications running on the PC. HP BASIC

# COMPUTER AIDED TEST Instrument Controllers (cont'd)



programs can control instruments, take measurements, and/or analyze data while the user is working a DOS applications such as a spreadsheet, word processor, or data base application. With software that comes standard with all PC-300s, HP BASIC programs in background and DOS applications in foreground can have bidirectional communication with each other. The HP BASIC program may control the DOS application, or the DOS application may control the HP BASIC program.

Optional DIO I/O cards, a GPIO card (HP 82306A) and a Shared Resource Manager (HP 50963A) are also available.

The HP E2080A LIF Utilities provides a convenient way to transfer files between the HP LIF and MS-DOS disk formats, and also provides other useful LIF-disk utilities for the PC.

### Measurement Coprocessor

The HP 82300C Measurement Coprocessor includes the following:

- Powerful BASIC-DOS communications libraries that allow the user to write HP BASIC programs to communicate with and control DOS applications.
- The ability to write data directly into a DOS application running in foreground. This feature is useful in process control applications that require continuous instrument monitoring and process control without interruption for data analysis, data display, or data reporting.
- Communication between multiple HP 82300Cs in the same PC. Up to 3 HP 82300Cs can operate simultaneously in a

single PC while the PC handles a fourth independent process. This provides the user with 4 independent processors to boost the performance of the system at a very low price per processor.

- HP BASIC data files written by the HP 82300C can be either DOS or Series 300 (LIF) compatible. This further enhances the compatibilities with HP 9000 Series 300 systems and with other PCs using DOS applications.

### HP 82323A Release II Upgrade Kit

The HP 82323A release II upgrade kit upgrades the HP 82300A/B Measurement Coprocessor to full release II compatibility (i.e., HP 82300C). This includes improved boot, graphics, and disk I/O performance. The upgrade consists of new software, documentation, and boot ROMs. The upgrade kit provides all of the performance improvements of the HP 82300C while protecting your original hardware investment.

### HP 82335A HP-IB Interface and Command Library

The HP 82335A HP-IB Interface and Command Library is a low-cost PC interface for controlling HP-IB devices using MS-DOS programming languages. The HP 82335A provides HP-IB interface hardware and command library software for controlling HP-IB (IEEE 488) instruments and HP-IB printers and plotters.

The HP 82335A can be used in HP Vectra PCs, IBM PC/XT/AT PCs, and other compatible MS-DOS computers. The HP-IB interface card fits into an 8- or 16-bit slot on industry-standard compatible computers.

The HP 82335A supports the following languages: Microsoft® QuickBASIC and Compiled BASIC, HPs Vectra BASIC, GW-BASIC®, IBM BASICA, Borland Turbo Pascal and Turbo C, and Microsoft Pascal, QuickC, and C.

In addition, the HP peripheral driver is included to add HP-IB capability directly to MS-DOS applications such as Lotus 1-2-3. By using DOS commands, outputs and inputs can be redirected to HP-IB printers and plotters.

### HP 82302A HP BASIC Self-study Course

An HP BASIC self-study course (HP 82302A) provides new users additional assistance. This self-paced course is an ideal way to quickly learn HP BASIC programming techniques for instrument control. This course includes practical examples of instrument control programs, which are provided on floppy disk with the course. Course material is applicable to any HP BASIC system, including the HP 9000 Series 200/300 controllers and PC 300 controllers.

### Convenient Ordering

The HP 82335A HP-IB Interface and Command Library, the HP 82302A HP BASIC self-study course, and the HP 82300C Measurement Coprocessor are available through HP DIRECT.

☎ For same-day shipment, call HP DIRECT at 800-538-8787.

GW-BASIC is a U.S. registered trademark of Microsoft Corporation.



### Controller Comparison

	HP PC-300 Controllers			HP 9000 Series 300 Controllers						
	286/12 PC-308	Q5 PC-312	RS PC-315	340	332	R/332	360	V/360	370	375
<b>OPERATING SYSTEM</b>										
MS-DOS	•	•	•							
HP BASIC/WS				•	•	•	•	•	•	•
HP-UX				•	•	•	•	•	•	•
<b>HP BASIC SUPPORT</b>										
HP BASIC/DOS	•	•	•							
HP BASIC/WS				•	•	•	•	•	•	•
HP BASIC/UX				•	•	•	•	•	•	•
<b>PROCESSOR</b>										
Main Processor	80286	80386	80386	68030	68030	68030	68030	68030	68030	68030 <sup>(5)</sup>
Clock Speed (MHz)	12	16/20	25	16.6	16.7	16.7	25	25	33	50
Math Coprocessor	80287	80387	80387	68882	68882 <sup>(1)</sup>	68882 <sup>(1)</sup>	68882	68882	68882	68882
Clock Speed (MHz)	12	16/20	25	16.7	16.7	16.7	25	25	33	50
HP BASIC Coprocessor	68000	68000	68000							
Clock Speed (MHz)	8	8	8							
<b>MEMORY CAPACITY</b>										
PC Memory (std)	640 Kbyte	1 Mbyte	1 Mbyte							
PC Memory (max)	8 Mbyte	16 Mbyte	16 Mbyte							
680X0 Memory (std)	1 Mbyte <sup>(2)</sup>	1 Mbyte <sup>(2)</sup>	1 Mbyte <sup>(2)</sup>	4 Mbyte	1 Mbyte	1 Mbyte	4 Mbyte	4 Mbyte	8 Mbyte	8 Mbyte <sup>(6)</sup>
680X0 Memory (max)	4 Mbyte	4 Mbyte	4 Mbyte	16 Mbyte	8 Mbyte	8 Mbyte	16 Mbyte	16 Mbyte	32 Mbyte <sup>(3)</sup>	32 Mbyte
<b>DISPLAY SYSTEMS<sup>(4)</sup></b>										
640x480 VGA	M/C	M/C	M/C							
512x400				M/C	M/C	M	M/C	M/C	M/C	
1024x768				M/C	M/C		M/C	M/C	M/C	M/C
1280x1024				M/C	M/C		M/C	M/C	M/C	M/C
<b>AVAILABLE SLOTS</b>										
PC CARDS (std/max)	7/7	7/7	7/7							
DIO I/O CARDS (std/max)	2/2 <sup>(2)</sup>	2/2 <sup>(2)</sup>	2/2 <sup>(2)</sup>	1/1	2/6	4/4	1/9	0/0	0/8	2/10
EXPANDER SUPPORT					•	•	•		•	•
<b>COMPUTATION</b>										
PC (MIPS)	1.5	3	4							
680X0 (MIPS)	0.6	0.6	0.6	4	4	4	6	6	8	12

(1) MC68882 Math coprocessor available as an option. MC68882 required for HP-UX or HP BASIC/UX operation.

(2) Only supported from HP Measurement Coprocessor (HP 82300C). Only available for use from HP BASIC/DOS.

(3) Maximum of 48 Mbyte RAM if ECC RAM is used.

(4) Resolution specified is in pixels. M=Monochrome, C=Color

(5) Upgrade to MC68040 25 MHz available

(6) ECC RAM standard, expandable to 128 MByte using 4 MByte chips.

# COMPUTER AIDED TEST

## Instrument Controllers

### Bundled Instrument Control Systems

Several bundled systems are available to simplify ordering of the best instrument controller for your application. All bundled systems

listed below are localized for a variety of international uses. For more information, contact your local HP sales office.

### PC-300 Instrument Controllers

HP BASIC/DOS	PC-308ML	PC-308CL	PC-308CM	PC-312CL	PC-312CM	PC-315CN
HP part number	82314F	82315F	82319F	82332E	82333E	82334E
Internal hard disk	20Mbyte	20Mbyte	40Mbyte	40Mbyte	40Mbyte	103Mbyte
VGA display type	Mono <sup>(1)</sup>	Color	Color	Color	Color	Color
Price	\$5,499	\$5,999	\$6,299	\$6,699	\$7,799	\$12,499

<sup>(1)</sup>The PC-308ML monochrome display options are Amber, Green, and White.

Hewlett-Packard offers six PC-300 instrument controllers based on a range of HP Vectra Personal Computers. Each PC-300 bundle includes the HP Measurement Coprocessor and built-in HP-IB,

1 Mbyte RAM (expandable to 4 Mbyte), 3 1/2-inch flexible disk drive and HP BASIC/DOS software.

### HP BASIC/WS Controllers<sup>(1)</sup>

HP BASIC/WS	332 MMA	332 CMA	R/332	R/332	R/332	360 MMA	360 CMA
HP part number	98580C	98581C	A1303A	A1305A	A1307	98580W	98581W
Internal hard disk	none	none	none	20Mbyte	40Mbyte	none	none
Internal flexible disk	none	none	3.5"	3.5"	3.5"	none	none
Touchscreen	<sup>(2)</sup>	<sup>(2)</sup>	<sup>(3)</sup>	<sup>(3)</sup>	<sup>(3)</sup>	<sup>(2)</sup>	<sup>(2)</sup>
Display type	Mono	Color	Mono	Mono	Mono	Mono	Color
Price	\$6,080	\$8,870	\$8,490	\$10,790	\$11,990	\$14,400	\$14,900

<sup>(1)</sup> Systems for HP BASIC/WS and HP BASIC/UX may be ordered for the V/360. For more information, please contact your local HP Sales Office

<sup>(2)</sup> Available as an additional product - HP Part Number 35723A

<sup>(3)</sup> Available as an option

Seven controller bundles are available for HP BASIC/WS operation. These systems provide the highest performance HP BASIC operation with a variety of price and performance choices. All bun-

dles include medium resolution (512x400) graphics, keyboard and HP BASIC/WS software.

### HP-UX, HP BASIC/UX Controllers<sup>(1)</sup>

HP BASIC/UX	332 MMAX	332 CMAX	360 MMAX	360 CMAX	375 CMAX
HP part number	98580CX	98581CX	98580WX	98581WX	98581JX
Display type	Mono	Color	Mono	Color	Color
Display resolution	1024x768	1024x768	1024x768	1024x768	1280x1024
Price	\$9,500	\$12,500	\$16,665	\$19,995	\$25,200

<sup>(1)</sup> Systems for HP BASIC/WS and HP BASIC/UX may be ordered for the V/360. For more information, please contact your local HP Sales Office.

There are five bundled solutions that offer the best of HP-UX and HP BASIC/UX. These bundles include high-resolution graphics, mouse, keyboard, and both HP-UX and HP BASIC/UX software. All HP BASIC/UX bundled systems also offer the option of a 152

Mbyte or 304 Mbyte disk drive with HP-UX and HP BASIC/UX installed and optimized for operation. Bundled prices listed below do not include disk options.



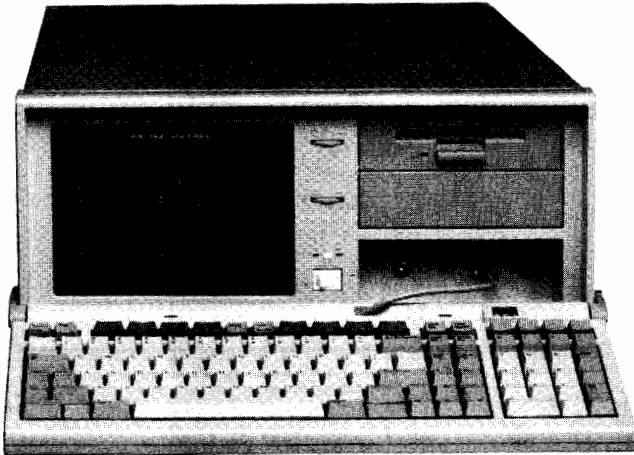

HP R/332 Rackmount Controller

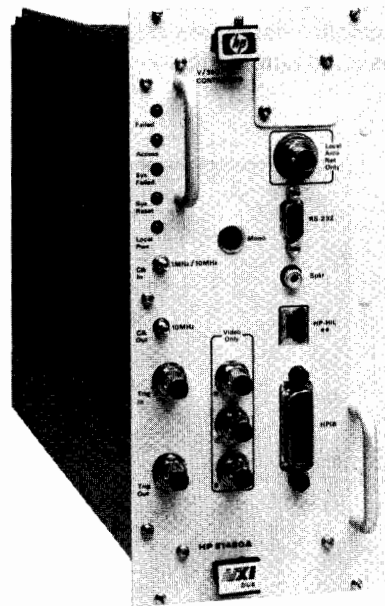

HP V/360 VXIbus Embedded Controller

### HP R/332 Controller

The R/332 controller is a Series 300 Model 332 computer which has been repackaged and enhanced to fit into a 19-inch rack, taking up only 7 inches in height, while integrating the keyboard, hard disks, flexible-disk drives, and a display. In addition to its small size, the R/332 offers hardware features which allow it to operate in rough environments. This controller can easily be rack mounted, or used as a benchtop device.

#### Compatible and Powerful

As a Series 300, the R/332 provides full compatibility with other Series 300 hardware and software and can run any application that other Series 300 controllers can. As a 68030-based controller, the R/332 provides four times the performance of a Model 310, with DMA on the processor board, a faster, more robust RAM architecture, and improved I/O expandability.

#### Rack-mountable

The R/332's compact and fully integrated package is optimized for rackmount applications, saving costly rack space. An equivalent modular controller would normally take up over half of a 6-foot rack when all components are rack-mounted. The R/332, in a package which includes a flexible-disk drive, hard disk drive, monitor, computer, keyboard, and 8 DIO/accessory slots, takes up only 7 inches.

#### Transportable

Because all components of the R/332 are integrated and built-in, it is much easier to transport than having to juggle separate components of a large computer system.

#### Rugged

The packaging is not the only feature that makes the R/332 ideal for rack-mount applications. Very often, equipment that is placed on racks must also be able to withstand harsh environments, be subjected to dust and the elements, or be subjected to vibrations. The R/332 has added features which make it very rugged and reliable, and has been tested extensively to comply to some of the most stringent regulatory certifications.

### V/360 VXI Embedded Controller

The V/360 is a VXI embedded controller which provides unparalleled performance, functionality, and flexibility in an integrated package. A wide array of choices in graphics subsystems, RAM capacity, operating systems, and application tools guarantees a perfect fit for your needs, in price, performance, and functionality.

#### Full Series 300 Compatibility and Performance

Because it is a re-packaged model 360, the V/360 guarantees full compatibility with operating systems and applications currently available for the Series 300 workstations. As a model 360, the V/360 comes equipped with a Motorola MC68030 processor and floating point co-processor, both operating at 25 MHz, a two-channel DMA controller and full 32-bit data and address bus to provide excellent performance and faster test program execution. RAM access is optimized by use of the 32-bit bus structures and can be ordered in increments of 4 Mbytes expandable up to 16 Mbytes. The V/360 is also loaded with standard interfaces and several choices in graphics subsystems.

#### Unparalleled VXI Functionality

The V/360 provides all the standard required Slot0 and commander functionality as called for by the VXI standard. It, however, goes above and beyond the requirements to provide additional enhancements without sacrificing compatibility and interoperability. Among these enhancements are transparent auto-configuration of Slot0 or non-Slot0, external trigger access, synchronization of VXI CLK10, both word serial and register access through the software, and an extra 256 Kbytes of memory (separate from main memory) for shared memory use.

#### Complete Software and Applications Support

As a complement to the operating system, routines are available for HP BASIC and HP-UX to perform many VXI tasks, provide excellent resource manager capabilities, and aid the user in troubleshooting and diagnosing the entire system. These routines are written such that the user has a choice between interactive and programmatic modes, allowing both automated and user-attended operation.

# COMPUTER AIDED TEST

## CAT Software

HP Interactive Test Generator (HP ITG)

- Accelerates test program development
- Mouse-driven interface to HP-IB instruments
- Full functionality instrument drivers
- Generates code automatically
- For HP BASIC controllers: Series 300 workstations, HP BASIC/UX controllers, and PCs with the Measurement Coprocessor
- For PCs using Microsoft C, QuickC, or QuickBASIC.

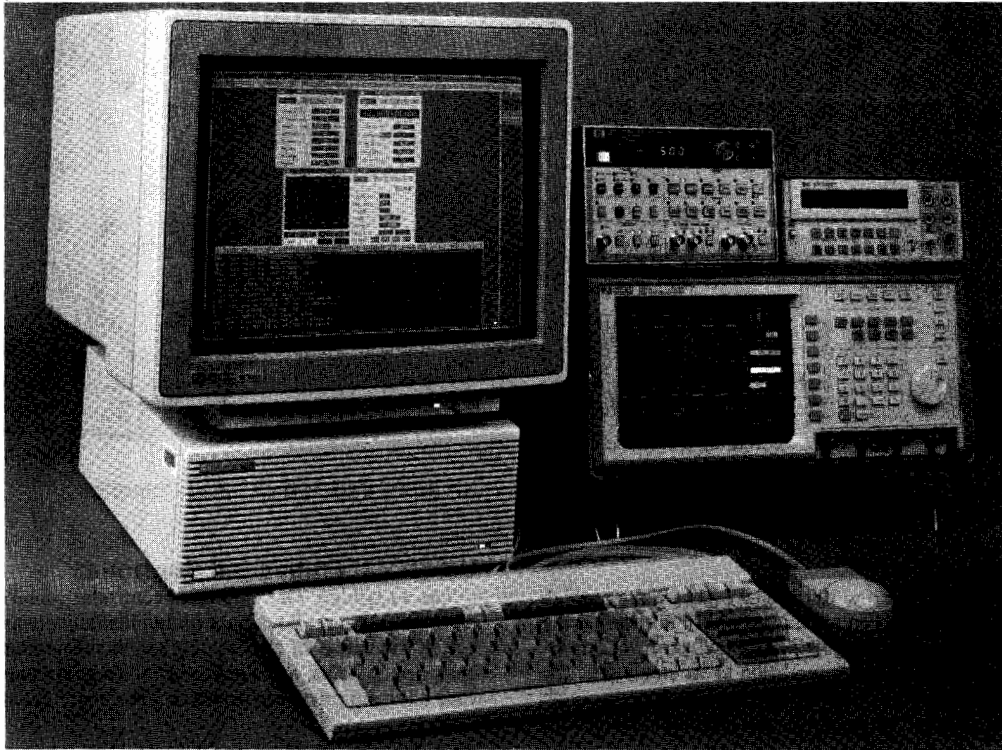

### Software Tools for Reduced Development Time

Hewlett-Packard provides a variety of CAT software tools to meet your needs, from general-purpose to specific applications. For general-purpose instrument control, the HP Interactive Test Generator software provides an easy-to-use interactive instrument driver library. For manufacturing test applications, HP's Functional Test Manager software provides a range of features that enable you to generate functional tests quickly and easily, and help you improve control of your manufacturing processes.

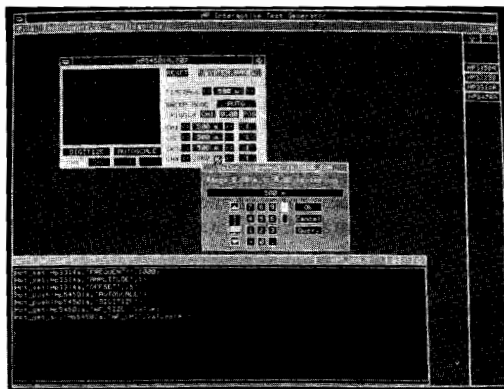

Menu selections expedite instrument setups and reduce costly errors

### HP Interactive Test Generator (HP ITG)

HP Interactive Test Generator (HP ITG) and HP ITG for DOS (HP ITG/DOS) are software packages that accelerate test development by providing powerful instrument control tools that integrate into your test development environment.

Designed for test engineers, independent of their programming skill, HP ITG reduces test development with on-screen instrument panels. Menu selections made with the click of a mouse prescribe settings of instruments, and initiate and display measurements. HP ITG also automatically generates the code necessary to perform these tasks in your test program.

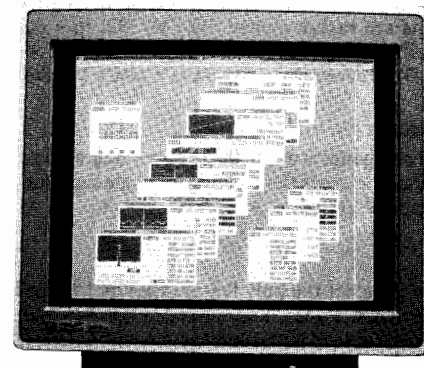

HP instrument drivers are available for wide variety of popular instruments

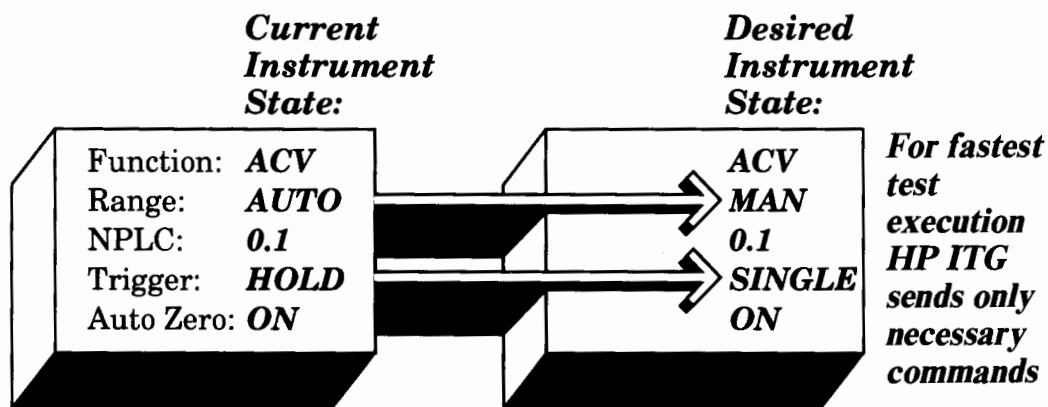

Incremental state programming ensures maximum throughput.

### Powerful Instrument Drivers

HP instrument drivers are designed to give you the full power available in your instrumentation. These drivers contain information on all instrument functions and how to access these functions. Additionally, HP instrument drivers contain the links between functions, assuring that the driver reacts just as the instrument front panel does. This assures that you have all the power of your instruments remotely, and that the software generated in HP ITG will execute with a minimum of errors.

### Wide variety of Supported Instruments

HP provides quality instrument drivers for many popular HP-IB test and measurement instruments. Although HP-written drivers address most applications, drivers for custom black boxes or non-supported instruments are easily created using any text editor and the tools available with the product. Additionally, the unique structure of HP instrument drivers allows the same instruments to be supported in both HP ITG products.

### On-line Help

At the click of a mouse, on-line help keeps the job moving with information on the operation of HP ITG as well as the specific instruments available. With instruments connected to the HP-IB bus, immediate feedback on an instrument's operation saves time debugging your instrument setups.

### Protected Software Investment

Because software development can easily cost as much as the instrumentation in a test system, protecting that software investment is as important as minimizing it.

The software generated with HP ITG for HP BASIC integrates into your existing HP BASIC test software. Whether you use custom programs or HP Functional Test Manager (HP FTM) software to create new applications, HP ITG serves as an easy and efficient tool for developing the measurement-specific part of your test.

Because HP ITG for DOS supports the full language capabilities of Microsoft QuickC, C, and QuickBASIC, HP ITG/DOS saves development time without abandoning your present software investment.

### Front Panels for VXI and MMS Instruments

HP ITG is particularly well-suited for VXI and MMS control. HP ITG gives users interactive front panels that don't exist on the actual instruments. Additionally, full functionality drivers assure that you can get the most out of your VXI and MMS instrumentation.

### Optimized for Test Development

HP ITG optimizes test throughput by automatically providing incremental state programming. HP ITG tracks the current instrument state and sends only the necessary commands to reach the next state. This eliminates time spent sending superfluous commands over HP-IB, as well as the time required for an instrument to interpret and respond to the command.

### HP ITG for HP BASIC

Code generated in HP BASIC retains the friendliness, power, and high performance that test developers have come to expect for instrument control. Full access to all HP BASIC math, graphics, and I/O capabilities gives HP ITG the edge as a friendly development environment without sacrificing application performance.

### System Requirements

#### HP ITG for HP BASIC

Runs on HP BASIC 5.1 or greater for all HP 9000 Series 300 HP BASIC workstations. Runs on HP BASIC/UX 5.5 or greater. Runs on Vectra-compatible PCs with the HP Measurement Coprocessor.

Additional requirements: HP-HIL or serial mouse, at least 3 Mbyte RAM (4 Mbyte for HP BASIC/UX), and at least 4 Mbyte of available hard disk space.

#### Code generated by HP ITG for HP BASIC

Code developed with HP ITG requires HP BASIC 5.1 or greater and at least 1.5 Mbyte RAM for execution on any HP 9000 Series 300 HP BASIC workstation or Vectra-compatible PC that supports the HP Measurement Coprocessor. Series 300 HP BASIC/UX workstations require at least 4 Mbyte RAM.

#### Ordering Information

	<b>Price</b>
<b>E2000A</b> HP Interactive Test Generator	\$995
Includes software and manuals	
Opt AA0 Software on 1/4-inch tape cartridge	\$0
Opt AA6 Software on 5-1/4 inch LIF disk	\$0
Opt AA7 Software on 3-1/2 inch single-sided LIF disk	\$0
Opt AA8 Software on 3-1/2 inch double-sided LIF disk	\$0
<b>E2001A</b> HP instrument drivers (One set includes all)	\$495
Opt AA0 Software on 1/4-inch tape cartridge	\$0
Opt AA6 Software on 5-1/4 inch LIF disk	\$0
Opt AA7 Software on 3-1/2 inch single-sided LIF disk	\$0
Opt AA8 Software on 3-1/2 inch double-sided LIF disk	\$0

### HP ITG for DOS

HP ITG for DOS supports common PC languages and hardware, allowing the code you generate to integrate directly into your current test system. The code generated integrates instrument mnemonics with the proper I/O commands, letting you concentrate on measurements, not methods.

#### System Requirements

HP ITG for DOS runs on all HP Vectra PCs, IBM PC-AT and 100% compatibles, and the Radix Micro VXI controller with at least 80286 CPU, 20 Mbyte hard disk, EGA, VGA or Hercules displays. Software required includes DOS 3.x or 4.0, Microsoft C version 5.x, QuickC version 2.0, or QuickBASIC version 4.5. Microsoft Windows/286 or Windows/386 can be used, but are not required.

Additional requirements: HP-HIL or serial mouse, at least 640K system memory and 1 Mbyte expanded memory, compatible HP 82335A or HP 82990A HP-IB interface, or National PCII series GP-IB interface.

#### Code generated by HP ITG for DOS

System requirements to execute software generated with HP ITG for DOS are the same as those for development except that many C applications will not require more than the default 640K memory. Most QuickBASIC applications will require expanded memory.

#### Ordering Information

	<b>Price</b>
<b>E2020A</b> HP Interactive Test Generator for DOS	\$1995
Includes software and manuals for HP ITG for DOS.	
Includes the full set of HP instrument drivers. Also includes the HP 82335A HP-IB interface card.	
Opt 335 Delete the HP-IB Interface card	-\$495
Opt AA6 Software on 5-1/4 inch high-density (1.2 Mbyte) disk	\$0
Opt AA8 Software on 3-1/2 inch high-density (1.44 Mbyte) disk	\$0

# COMPUTER AIDED TEST

## Functional Test Manager Software

HP FTM/300 and FTM/PC

- Available on HP 9000 Series 300 BASIC workstations and HP-UX workstations running HP BASIC/UX, and on HP Vectra PCs with HP Measurement Coprocessor.
- Improve functional test processes with statistical analysis.
- Substantially reduce your test system development time.



HP FTM/300

### HP FTM Functional Test Manager

HP FTM functional test manager software is a test executive that improves the functional test process by reducing time-to-market and reducing test station downtime. HP FTM includes powerful turnkey features, so you write less code. Turnkey user password security and HP-HIL bar-code wand compatibility keep operators from accidentally modifying test programs. Turnkey statistical analysis improves the test process.

HP FTM fits well into the test development process. It provides a standard test development environment. Most programming is done with forms that are very easy to fill out and self-documenting to save time.

#### Powerful Turnkey Features

Start functional test system software development with HP FTM, and start out "already finished" with many of your most difficult development tasks. HP FTM provides you with up to 65% of your test system software. It does this by taking care of the non-application specific portions of the system software; parts that are typically the same from one test system to another. Develop your next test system quicker using all of HP FTM's powerful turnkey features:

- Turnkey System Security
- Turnkey Test Scheduling
- Turnkey Test Sequencing
- Turnkey Test Debug Mode
- Turnkey Database Management
- Turnkey SQC Data Analysis
- Turnkey Networking

Standardize On The  
Complete Set Of  
HP FTM Turnkey Features

Use these flexible features to quickly build test systems that do more than most custom-coded systems. Many customers have already standardized on HP FTM turnkey features for all functional test systems.

#### Test Development And System Configuration Tools

Using HP FTM's turnkey tools means you can concentrate harder on your application specific tasks. Application specific tasks typically include defining tests and test parameters and coupling HP FTM's turnkey features into your overall application environment. HP FTM has system configuration and test development tools to help you in these application specific areas.

HP FTM development tools are both easy to use and extremely powerful. They combine the friendliness of menus and forms with the ultimate power and flexibility of HP BASIC programming language. Quickly finish the application specific portion of your functional test software using HP FTM:

- **Menu of forms**  
Use HP FTM's forms to conveniently document, access and modify your test parameter and test system configuration data.
- **Library of optimized subs**  
Use these subs and quickly build individual tests tailored to your specific needs.
- **Full access to HP BASIC**  
With HP BASIC, add custom test capabilities to HP FTM or use your existing subprograms.  
Combining HP FTM's turnkey features with its development tools, you retain all the advantages of writing custom software while substantially reducing your development time and effort.

#### Optimized For Test Throughput

While HP FTM provides high level testing capabilities in real time (e.g., HP-IB driver I/O, pass/fail limit testing, data archiving, test sequencing, test progress reporting, etc.), HP FTM still executes HP-IB I/O and test sequencing just as fast as most custom written test software. However, for even faster program speed or higher flexibility, custom code critical test segments using powerful HP BASIC. The structure of HP FTM allows straightforward integration of HP BASIC callable custom code.

Further optimize your overall testing speed by taking advantage of HP FTM's intelligent test sequencer. Set up HP FTM's Test Plan Form so that certain tests are executed only under certain conditions. For example, execute an overall functional test first. Whenever this test fails, then execute a set of troubleshooting tests to gather more information on the cause of the failure. You don't need to execute the troubleshooting tests every time. Or, specify a lengthy set of tests as "audit tests" to be executed only on every Nth device under test. With HP FTM's intelligent test sequencer you get more of your product out the door faster.

### Flexible Test Program Scheduling

Your test system tasks may need to be executed upon specific events or at specific times. With HP FTM, schedule your tasks to be executed upon the wave of a barcode wand, at specific times of day, or upon operator menu selection. At the same time HP FTM will save important information with your test result data, information such as serial numbers, time of test, operator information and networked test station #.

For your less sophisticated operators, use HP FTM's security levels to tailor HP FTM's operator menu to each operator, allowing only specific menus to be seen and executed by specific operators. HP FTM's turnkey security and scheduler features give you flexibility to display, schedule and initiate tasks the way you want.

### Data Analysis and Report Generation

Analyze and improve your production process in addition to testing your products. Use HP FTM to monitor trends in your process with its turnkey statistical quality control (SQC) analysis features. Improve your process and your profits by monitoring test result trends as you tune your production process. And HP FTM will generate important SQC reports and graphs. Use HP FTM's SQC overview page as your management summary. It lists yield, units passed or failed, and presents information graphically. For more detailed reporting, use HP FTM to produce the following SQC charts and graphs:

- Pareto charts for failure analysis
- Histograms of test results
- Control Charts (p, X-bar and s) as process monitors

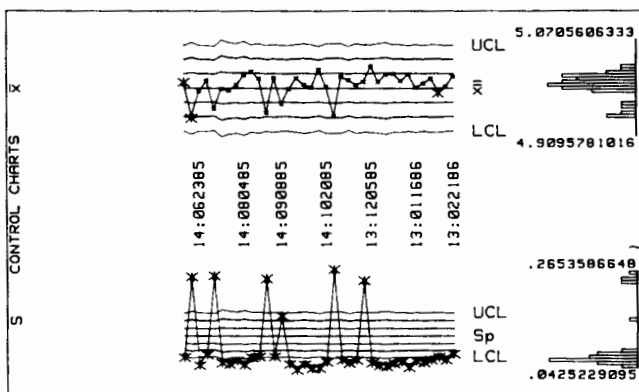

### Networking and Data Transfers to Other Computers

Format your test results and transfer them to other computing environments for further analysis or archiving. HP FTM formats test data files in the standard ASCII formats (CSV and DIF) used by nearly all major software packages.

HP FTM networking features let you use any common file transfer means including RS-232, HP-IB, HP's Shared Resource Manager (SRM), or IEEE 802.3 (using HP's SRM network and a co-existing HP-UX environment). Use HP Advancelink and HP FTM for total turnkey transfers of data over RS-232C to DOS computers. The resultant DOS files are ready for access by spreadsheets such as Lotus 1-2-3 and database managers such as dBASE III Plus.

HP FTM software is specially designed to take full advantage of HP's SRM network. Multiple HP FTM systems can be linked to share a common data base for data storage and SQC analysis. HP FTM's SRM networking can also be used to transfer test data from HP FTM to HP Q-STATS II area-wide information manager. HP Q-STATS II, working with the HP 306X Board Test Systems and HP FTM at functional and final test provides a comprehensive "board-test-to-final-test" statistical quality control solution.

### Standardize On HP FTM For All Your Test Systems

Implement just one test system using HP FTM and see the time saving benefits of reduced software development time, maintenance and documentation. Standardize on HP FTM and experience the additional effect of having your newer test engineers understand and maintain both new AND old systems. Using and training your new test engineers on HP FTM's standard database, data structures and other turnkey features gives them a big headstart in understanding and maintaining all your HP FTM based systems. Examining the information in HP FTM's forms will complete the picture, making it easy and quick for new engineers to grasp the inner application specific elements of any previously unfamiliar system.

### Summary

HP's Functional Test Manager is a sophisticated, comprehensive and flexible software package fine tuned for functional test applications in production environments using HP-IB test instrumentation. It provides the set of features most needed to run a modern, versatile production operation. HP FTM has the breadth and depth needed to be considered as your standard test system executive.

Use HP FTM to beat your functional test software development deadlines while simultaneously expanding the functionality and flexibility of your test systems.

### Product Requirements

#### Supported Computers

HP 9000 Series 200\*/300 controllers and HP Vectra (or 100% IBM AT compatible) PC equipped with the HP BASIC Language Processor.

#### Operating System

HP BASIC 5.X or greater and HP BASIC/UX 5.X or greater. Must order HP BASIC HFS binary (HP 82313A) separately for HP FTM/PC unless using SRM.

#### Memory

3 Mbytes recommended for development system (2.25 Mbytes minimum), 2 Mbytes for run-only. For HP FTM/PC this memory must reside on the HP BASIC Language Processor.

#### Hard Disc

Local hard disc required unless using SRM. Recommend 20 MBytes (40 Mbytes for HP FTM/PC if hard disk is shared with DOS applications).

#### Printer

Optional. HP-IB, RS-232 or Centronics (on PC) interfaces with HP Raster Interface Standard capability. For example, HP ThinkJet, HP LaserJet and HP PaintJet.

#### Plotter

Optional. HP-IB, HPGL (automatic sheet feed desirable).

#### Bar Code Reader

Optional. Use HP 92916A (HP-HIL).

#### 32-Button Box

Optional. Use HP 46086A (HP-HIL).

### Ordering Information

	Price
<b>HP FTM/300</b> (for HP 9000 Series 200/300 Computers under HP BASIC 5.X or greater)	
<b>HP 34806A</b> FTM/300 on 3 1/2 inch disk. Includes one seat in training class.	\$5,049
Opt 001 Delete training	-\$900
<b>HP 34806B</b> FTM/300 on 5 1/4 inch disk. Includes one seat in training class.	\$5,049
Opt 001 Delete training	-\$900
<b>HP FTM/PC</b> (for HP Vectra PCs (and compatibles) with HP BASIC Language Processor)	
<b>HP 34806C</b> HP FTM/PC on 3 1/2 inch disk. Training not included.	\$3,417
<b>HP 34806D</b> HP FTM/PC on 5 1/4 inch disk. Training not included.	\$3,417
<b>HP FTM/300 for HP-UX</b> (for HP 9000 Series 300 computers with HP BASIC/UX 5.5 or greater)	
<b>HP 34806E</b> HP FTM/300 on 1/4 inch tape. Includes one seat in training class.	\$5,049
Opt 001 Delete training	-\$900

### Multiple Copy/Right-To-Use Licenses, Upgrade Kits, Training & Support Materials

Economical multiple copy/right-to-use licenses, upgrade kits for Rev 1.0 and 2.0, user training and Software Materials Subscription (SMS) are available for HP FTM/300 and HP FTM/PC. For more information on these products ask your local HP Sales Representative.

Lotus and 123 are registered trademarks of Lotus Development Corporation. MS-DOS is a registered trademark of Microsoft, Incorporated.

\*HP Models 216 and 220 require display enhancements. HP Model 226 not supported.

## COMPUTER AIDED TEST Switching/Interface Hardware

The philosophy behind computer-aided test (CAT) is simple. If you can raise the quality of your product without raising its cost, your customer is happier and your company is more productive. The formula for executing this plan is equally simple: monitor incoming parts, manufacturing processes and final products in great detail, and make corrections to improve them.

While the philosophy is simple, the implementation can sometimes be complex. HP can help, with a full complement of computers, software, instruments, switches, and interconnect hardware designed specifically to make your CAT task easier.

A good CAT system is designed to improve manufacturing productivity. It minimizes the design time to build fixtures, write software and configure systems, and it also minimizes the time required to test devices.

### What to Look for in Hardware Cardcages

Performance is the main criteria in selecting instruments and switches. The switch and instruments must meet your stringent requirements. It is a good idea to select an instrument and switch with slightly more performance than the initial specification requires. That way you can easily adapt to

changing manufacturing specifications. Another consideration is throughput speed. An intelligent cardcage system, such as the HP 3235A, can run subroutines and make decisions, thereby off-loading the host computer to do the test sequencing and data reporting.

The HP Series 6900 multiprogrammers are high-performance CAT products offering very high-speed stimulus and response functions. The broad function versatility and inter-card communication of its I/O cards give the multiprogrammer the required adaptability to make time-critical measurements. Series 6900 multiprogrammer I/O cards can be used in either the HP 6954A, the HP 6944A or the HP 6942A mainframes. These I/O cards give the multiprogrammer abilities such as digital I/O rates up to 1 MHz and analog acquisition rates up to 500 kHz that can be synchronized with application-dependent events.

If your budget or application is relatively small, look to the HP 3488A switch/control unit.

### Switching

If your application involves switching signals >1 MHz, you need to look at the

HP 3235A for large point counts (>100), the HP 75000 Series B for medium point counts, and the HP 3488A for low point counts. All three products offer high-performance switching in various topologies covering dc to 26.5 GHz.

### Interfacing and cabling

For years, the cabling and fixturing of a CAT system have been neglected by CAT manufacturers. Test engineers and technicians had to build their own connection systems. But, today HP has commercial units to do most of the critical switching and cable management necessary in a CAT system. The availability of these switch units can save hundreds of hours of design time.

The interface system to the HP 3235A standardizes the way you cable your unit-under-test to the test system. It adapts to complex components, pc boards, subassemblies and systems.

For those who need help in configuring, implementing, or supporting a complex CAT system, HP offers the ATS 2000, which provides an integrated solution (including hardware, software, racking, cabling and system-level support).

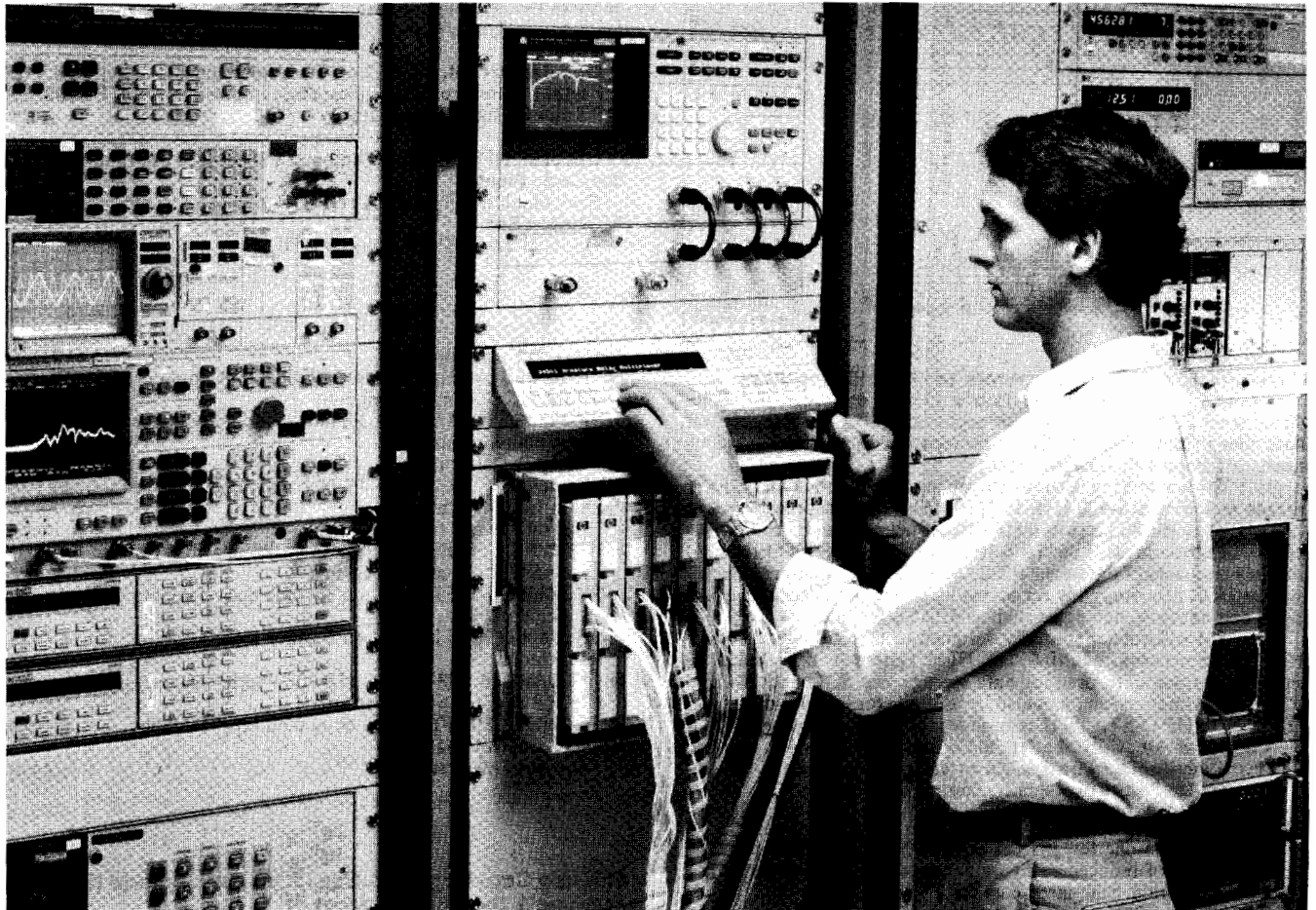

The HP 3235A switch/test unit performs high-integrity switching for signals from dc to 26.5 GHz. With its mass interconnected fixture, the HP 3235A can route signals from many instruments to the device under test, saving the test engineer the chore of designing a custom switch, and greatly simplifying cable management.

Programming the HP 3235A is extremely efficient, with high-level BASIC commands. Faster test throughput speed is created by downloading test setups and by direct communication between the internal switches and the internal 6½-digit multimeter or internal stimulus.

- For medium to large systems
- 10-Slot, intelligent card cage
- 20-switch modules for DC to 26.5 GHz signals

- DMM, AC/DC source, 4-channel D/A digital I/O, breadboard modules
- Quick interconnect fixture
- Control panel for debugging

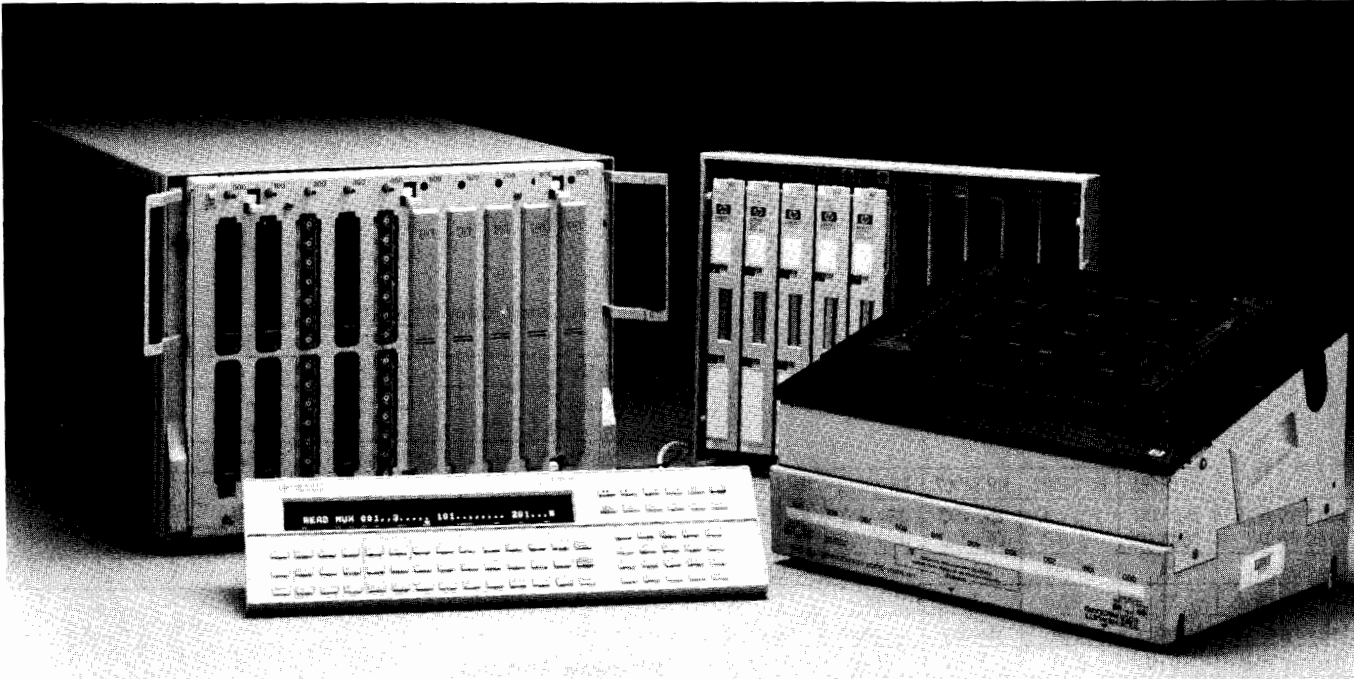

HP 3235A

### Description

The HP 3235A Switch/Test Unit reduces test development of HP-IB production test systems by providing high performance off-the-shelf switching and interfacing to a wide variety of Devices Under Test (DUT).

This Switch/Test Unit routes signals between your DUT and source/receiver instruments such as digital multimeters, counters, signal sources and analyzers.

Speed your test system development with:

- off-the-shelf tools
- easy programming
- reduced cabling

Your test system throughput increases with the HP 3235A's:

- intelligence
- plug-in digital multimeter module
- internal bus structure
- Quick Interconnect Fixture

### A Reconfigurable Architecture

The HP 3235A chassis is a 10-slot cardcage driven by a 16-bit processor backed with 256k of firmware. You control the cardcage over HP-IB using high level commands for easy programming. Twenty different switch modules in various matrix and multiplexer topologies switch signals up to 10 Amps and from DC to 26.5 GHz. Also available are digital I/O, breadboard, four-channel D/A, DMM, and AC/DC source modules that are true "instruments-on-a-card."

For applications demanding numerous switch points, up to seven 10-slot HP 3235E Extenders can be slaved to the HP 3235A mainframe. 20,480 two-wire analog points can now be controlled from one HP-IB address.

The Quick Interconnect Fixture allows easy reconfiguration of the customer's test system for different test devices. Operator errors are also reduced by minimizing the number of connections that must be made before starting a new test.

Four analog and two trigger buses link the switch and instrumentation modules. These internal paths provide a "soft-wired" connection

that can be redefined by your test software. Analog signals get routed conveniently from a multiplexer to the digital multimeter module during scanning. Or, a trigger generated by the digital I/O module can be routed to the digital multimeter module.

To aid in system set up and debugging, a control panel with a full alpha-numeric keypad and electro-luminescent display is available.

### Intelligence of a Computer

The powerful firmware of the HP 3235A instructs the plug-in modules with high level commands from the host computer. Storage and recall of hundreds of HP 3235A setups saves sending command sequences from the computer. BASIC language commands in the mainframe such as IF . . . THEN and FOR . . . NEXT, plus variables and math functions keep computer to switch interactions to a minimum, thereby increasing throughput. Use up to 480K bytes of mainframe memory for downloaded subroutines and stored values. Downloaded programs, including user defined data conversions or setups, execute rapidly.

### Complete Modularity Means In-Rack Service

The HP 3235A is completely in-rack serviceable, so you never need to remove the card cage from the rack. All assemblies, including power supply, controller, and HP-IB, remove easily because of the modular design.

### Simple Operational Verification Before Your Test

The HP 3235A offers three levels of internal self-test as well as a fixtured functional test for the individual plug-in modules. The fixtured test is performed using diagnostic terminal blocks that attach to the modules. These diagnostic fixtures, together with the internal DMM module, verify the integrity of the relay contacts in your system.

### HP 3235A Plug-in Modules

A full complement of functional plug-in modules is available for use with the HP 3235A 10-slot mainframe or the HP 3235E 10-slot extender.

# COMPUTER AIDED TEST

## High Performance Switching and Control (cont'd)

HP 3235A

### Low Frequency Relay Multiplexers

These modules can be used either as input or output multiplexers to switch signals to and from a device under test (DUT). The multiplexers are two-wire, switching both High and Low. They have different voltage and current switching capabilities, and use different relay types. The HP 34501T/34502T/34507T can also be used with thermocouples. For matrix applications, see below.

32 Channel Multiplexers (one bank shown)

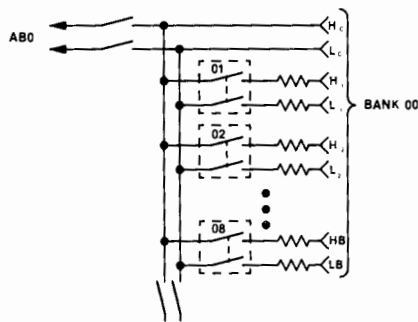

	HP 34501	HP 34502	HP 34507	HP 34511	HP 34515
Max Voltage (AC RMS)	250 VDC 250 VAC	125 VDC 90 VAC	250 VDC 250 VAC	130 VDC 130 VAC	1000 VDC 1000 VAC
Max Current	2A	25 mA	100 mA	1 A	1 A
No. of Channels	32	32	32	64	10
Relay Type	Armature	Reed	Mercury	Armature	Reed
Thermal Offset	<3 uV	<3 uV	<20 uV	<7 uV	<30 uV

### High Frequency Relay Multiplexers

These multiplexers provide broadband switching of high frequency analog or digital signals. The HP 34504 switches both the center conductor and the shield. In the HP 34505 and HP 34508, the three multiplexer banks are isolated from each other and from ground, preventing ground loops.

Switched-Shield Coaxial Multiplexer (one bank shown)

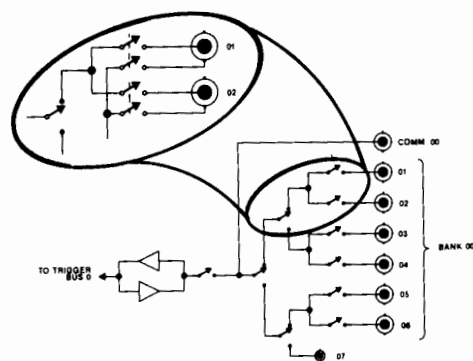

RF Multiplexer (one bank shown)

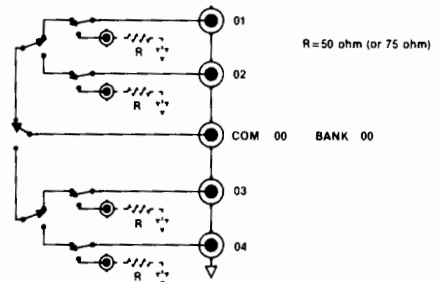

### High Frequency Relay Multiplexers

	HP 34504	HP 34505	HP 34508
Bandwidth	100 MHz	1.3 GHz	1.3 GHz
Number of Channels	Dual 1x6	Two 1x4 One 1x3	Two 1x4 One 1x3
Impedance	50 ohms	50 ohms	75 ohms
Maximum Voltage (AC RMS)	42 VDC 30 VAC	42 VDC 30 VAC	42 VDC 30 VAC
Maximum Current	1 A	1 A	1 A
Switched Shield	Yes	No	No

### Microwave Switches

These 50 ohm coaxial switches provide excellent electrical performance from DC to microwave frequencies. The HP 34530A goes to 18 GHz, while the HP 34530B goes to 26.5 GHz. The HP 34531A/B 18 GHz multiplexers are configured as 1x6. The HP 34531B has internal 50 ohm terminations for the open channels, while the HP 34531A does not. All of these microwave switches use SMA connectors. A variety of rack panel mounting kits are available. Up to four HP 34530A/B 3-port switches can also be mounted in the HP 34530T terminal block kit.

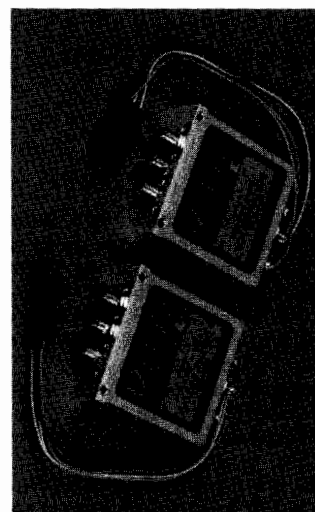

HP 34530A/B

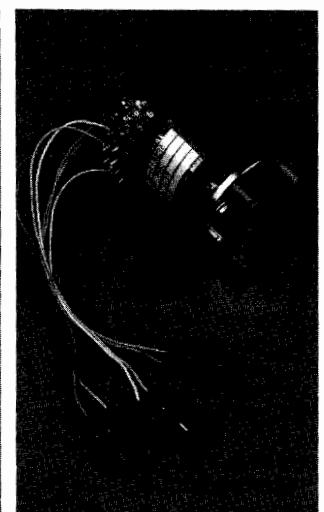

HP 34531A



**Relay Matrix Modules**

These matrix cards come in a variety of configurations, densities, and bandwidths. For the highest density, consider the HP 34511M or the HP 34516M/N. If low leakage is a requirement, the HP 34512C features 10 pA/volt leakage, 2 pA/V typical. For higher bandwidth applications, look at the HP 34506 Switched Shield Matrix. Finally, for very high frequency applications, consider using the HP 34513C or the HP 34514C General Purpose RF relay modules (described in a later section) to build up your own custom high frequency matrices. Special cable kits allow many of these modules to easily expand into larger matrix configurations.

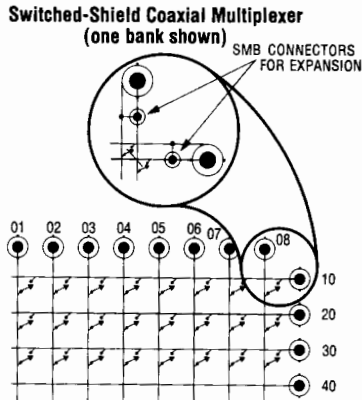

**HP 34516N Two-Wire 256 Crosspoint Matrix**

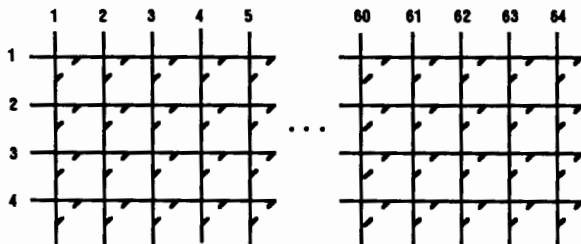

**Relay Matrix Modules**

	HP 34501M	HP 34506	HP 34511M	HP 34512	HP 34516
Crosspoints	32	32	64	32	256
Matrix Configuration	4x8	4x8	8x8 4x16	4x8	8x32 4x64
Bandwidth	1 MHz	30 MHz	1 MHz	30 MHz	1 MHz
Max voltage (AC RMS)	42 VDC 30 VAC	42 VDC 30 VAC	130 VDC 130 VAC	250 VDC 170 VAC	42 VDC 30 VAC
Max Current	2 A	1 A	1 A	1 A	1 A
Connectors	Two-wire	Coaxial	Two-wire	Triaxial	Two-wire
Switched Shield	No	Yes	No	Yes	No

**General Purpose Relay Modules**

There are several general purpose modules available for different applications. The HP 34503 has 16 Form C relays. The HP 34510 has 8, but can switch 10 amps per relay. The HP 34513 and HP 34514 are essentially building blocks, allowing you to build up custom switching topologies to fit your requirements. These cards contain 32 independently operated double-pole double-throw high frequency relays. All contacts are brought out to board mounted SMB connectors. Inter-connection between relays are made via coaxial cables.

**General Purpose Relay Modules**

	HP 34503	HP 34510	HP 34513	HP 34514
Number of relays	16	8	32	32
Contact Config	SPDT (Form C)	SPDT (Form C)	DPDT	DPDT
Maximum Voltage (AC RMS)	250 VDC 250 VAC	125 VDC 250 VAC	42 VDC 30 VAC	42 VDC 30 V AC
Maximum Current	3 A	10 A	1 A	1 A
Bandwidth	1 MHz	1 MHz	1 GHz	300 MHz
Use	General Purpose	Power Actuator	50 ohm RF Switching	75 ohm RF Switching

**Digital I/O Modules**

The HP 34509 has a total of 32 open-drain MOS-FET outputs available, which can switch voltages up to 42 volts and currents up to 0.5 A. This card also contains two internal power supplies of 15V and 28V, making the module ideal for driving relay coils or other devices. This card is also used in conjunction with the HP 34530 and HP 34531 Microwave switches.

The HP 34522 is a 32 Bit Digital I/O module, featuring 32 bi-directional TTL-compatible data lines, 8 edge-triggered interrupt lines, 16 high-power FET outputs, and a read/write rate > 40 kHz. The 32 data lines are configured as four 8-bit ports, each with their own handshake lines. Each port can be operated independently as a read or write port, or can be combined to handle 16 or 32 bit parallel data.

**Analog Source Cards**

The HP 34521 AC/DC Source card offers 24-bit (6.5 digit) resolution in the DC voltage mode, highly accurate amplitudes in the AC voltage mode, and versatile high speed outputs in the arbitrary waveform mode. Maximum voltage output is ±10 volts, while maximum frequency is 1 MHz. Standard AC outputs include sine, square, and triangle waveforms, with variable duty cycle on both triangle and square waves. AC outputs are generated by direct digital synthesis which provides high accuracy and resolution down to 0.001 Hz. Arbitrary waveform memory depth is 2048 bytes. ARB's can be generated at a full 1 MHz bandwidth.

The HP 34524 contains four completely independent 14-bit plus sign digital-to-analog converters. In the voltage mode, each DAC can supply ±10.24 volts. In current mode, each can provide ±20.16 mA. Because the four DACs are isolated from one another, they can be connected in series or parallel for greater output voltages or currents.

**Breadboard Module (HP 34523)**

The breadboard module furnishes a convenient way to incorporate special purpose circuits into your test system. This module lets you interface directly the HP 3235A's backplane control signals and backplane analog and trigger buses.

**6½ Digit Multimeter Module (HP 34520)**

With the DMM module, you can integrate a high performance system multimeter into your test system without extensive cabling and software programming. The DMM module offers seven functions:

- DC volts with five ranges from 0.03V to 250V and reading rates >1450 rdgs./sec in the 3½ digit mode.
- AC Volts with 1MHz AC Bandwidth
- Two and four-wire resistance measurements
- DC current up to 1.5A, with reading rates as fast as DC Volts and ohms
- AC Current up to 100kHz and 1A.
- Frequency and period from 10 Hz to 1.5MHz with 6½ digit resolution.

The DMM module combines superb analog measurement capability with powerful system flexibility. Measurement inputs can be switched directly from the front of the module or, with the exception of current inputs, from any of the four internal HP 3235 analog buses.

# COMPUTER AIDED TEST

## High Performance Switching and Control (cont'd)

### HP 3235A

#### DC Voltage (90 day, Tcal $\pm 5^\circ\text{C}$ )

Range	Best 6½ Digit Accuracy <sup>1</sup> $\pm$ (% of reading + volts)	Input Resistance
30mV	0.0053% + 5.40 $\mu\text{V}$	>10 G $\Omega$
300mV	0.0038% + 5.7 $\mu\text{V}$	>10G $\Omega$
3.0V	0.003% + 8 $\mu\text{V}$	>10G $\Omega$
30V	0.0048% + 220 $\mu\text{V}$	10 M $\Omega \pm 1\%$
250V	0.0063% + 700 $\mu\text{V}$	10 M $\Omega \pm 1\%$

#### DC Current (90 day, Tcal $\pm 5^\circ\text{C}$ )

Range	Best 6½ Digit Accuracy <sup>1</sup> $\pm$ (% of reading + amps)	Max. Burden Voltage at Fullscale
300 $\mu\text{A}$	0.025% + 15.4 nA	0.35 V
3mA	0.025% + 15.4 nA	0.35 V
30mA	0.025% + 1.54 $\mu\text{A}$	0.35 V
300mA	0.088% + 25.4 $\mu\text{A}$	0.6 V
1.5A	0.088% + 654 $\mu\text{A}$	1 V

#### Resistance (2 and 4-wire ohms)<sup>2</sup> (90 day, Tcal $\pm 5^\circ\text{C}$ )

Range	Best 6½ Digit Accuracy <sup>1</sup> $\pm$ (% of reading + ohms)	Current Output
30 $\Omega$	0.0078% + 5.4m $\Omega$	1mA
300 $\Omega$	0.0058% + 5.7m $\Omega$	1mA
3k $\Omega$	0.0048% + 9m $\Omega$	1mA
30k $\Omega$	0.0048% + 90m $\Omega$	100 $\mu\text{A}$
300k $\Omega$	0.006% + 1 $\Omega$	10 $\mu\text{A}$
3M $\Omega$	0.008% + 15 $\Omega$	1 $\mu\text{A}$
30M $\Omega$	0.032% + 830 $\Omega$	100 nA
300M $\Omega$ <sup>3</sup>	2.5% + 100k $\Omega$	100 nA
3G $\Omega$ <sup>3</sup>	25% + 1M $\Omega$	100 nA

1. After one hour warm up, integration time 100 PLC. Tcal is the temperature of the calibration environment between 18 and 28°C.

2. For two-wire ohms, add 200M $\Omega$  to count error specifications.

3. For two-wire ohms only accuracy is specified following auto-cal (ACAL), under stable conditions ( $\pm 1^\circ\text{C}$ ).

#### AC Voltage (RMS AC and RMS AC+DC)

ACV Bandwidth: 20 Hz to 1 MHz

Crest Factor: 3.5 to 1 at fullscale

Common Mode Rejection with 1 k $\Omega$  imbalance in the low lead, DC to 60 Hz. Guarded: >86dB; non-guarded >66dB.

#### AC Volts (90 day, Tcal $\pm 5^\circ\text{C}$ )

Range	(100Hz to 20kHz) Best 5½ Digit Accuracy <sup>1</sup> $\pm$ (% of reading + % of range)		Input Impedance
	AC Coupled	DC Coupled	
30mV	0.15% + 0.0441%	0.19% + 0.169%	1M $\Omega \pm 1\%$
300mV	0.15% + 0.0441%	0.19% + 0.169%	shunted by
3.0V	0.15% + 0.0441%	0.19% + 0.169%	<90pF
30V	0.15% + 0.0441%	0.19% + 0.169%	
300V	0.21% + 0.053%	0.25% + 0.203%	

1. Accuracy specified for sine wave inputs, >10% of range. DC component <10% of AC component after one hour warm up and within one week of autocal. AC band set to <400 Hz.

#### AC Current (RMS AC and RMS AC+DC)

ACI Bandwidth: 20 Hz to 100 kHz

Crest Factor: 3.5 to 1 at fullscale

**Frequency and Period:** Measures the frequency or period of the ac component of the ac or dc coupled voltage or current input. The counter uses a reciprocal counting technique to give constant resolution independent of input frequency.

**Frequency Range:** 10 Hz to 1.5 MHz (voltage input)  
10 Hz to 100 kHz (current input)

**Period Range:** 0.1 s to 667 ns (voltage input)  
0.1 s to 3.33  $\mu\text{s}$  (current input)

**Sensitivity:** 10 mV RMS or 100  $\mu\text{A}$  RMS (sinewave)

**Triggering:** Triggers and counts on zero crossings.

#### SimPlate Board Test Fixture (HP 34597A)

The HP 34597A SimPlate Board Test Fixture is a vacuum actuated bed-of-nails test fixture kit for the HP 3235A Switch/Test Unit. SimPlate and the HP 3235A are tools developed for your "rack-and-stack" functional test systems. Unlike an edge connector test, SimPlate gives you access to all component leads to provide more functional test flexibility and improved fault isolation. Because of its unique single plate design, SimPlate can provide the close tolerance probing required for interfacing to Surface Mount Technology (SMT) boards.

SimPlate is delivered as a kit, that you must drill, wire, and assemble. The components in this kit are designed to probe printed circuit boards from a single side, with test pads as small as 0.030" diameter on 0.050" centers. Probes, receptacles and extra HP 3235A terminal blocks are ordered separately.

#### Environmental:

Operating Temperature: 0-55 C (32-130 F)

Storage Temperature: -40 -75 C (-40 -165F)

Humidity Range: 95% R.H., 0 to 40 C

#### Power:

Line Voltage: 90-132V (115V) or 192-264 (230V) switch selectable  
47-66 Hz. Fused at 5A (115V) or 2.5A (230V).

#### Size:

HP 3235 Cardcage: 310mm H (without feet) x 426mm W x 594 mm o (12.25"x16.75"x23.4")

Height with Feet: 325mm (12.8")

Depth with Terminal Blocks: 693mm (27.3")

#### Weight

HP 3235 Cardcage (max.)

Each Module (max.)

#### Net

21 kg (46 lbs)

5.5 kg (12 lbs)

#### Shipping

28 kg (61 lbs)

6.6 kg (14.5 lbs)

#### Ordering Information

HP 3235A Switch/Test Unit

Opt 560 Add System Expansion Card

Opt 580 HPIB Controller

Opt 590 Add Quick Interconnect

Opt 908 Rack Mount Kit (HP P/N 03235-80908)

HP 3235E Switch/Test Unit Extender

HP 34550A Control Panel

HP 34551A Control Panel Rack Mount Kit

#### Price

\$5455

+\$430

+\$695

+\$910

+\$115

\$4545

\$730

\$65

**Plug-in Accessories** are supplied with your choice of terminal blocks. "A" suffix designates solder lugs, "B" suffix designates screw terminals, "C" suffix deletes the terminal block, "M" and "N" suffixes designate matrices, and "T" suffix is used to measure thermocouples. Prices are shown below for the "B" suffix.

HP 34501A/B/M/T 32-chan Armature Rly \$1870

Mux/Matrix

HP 34502A/B/M/T 32-chan Reed Rly Mux/Matrix \$1870

HP 34503A/B General Purpose Relay Module \$1170

HP 34504A/B/C Switched-Shield Coax Mux \$2000

HP 34505A/B/C 50 Ohm RF Mux \$1770

HP 34506A/B/C Switched-Shield Coax Matrix \$2275

HP 34507A/B/M/T 32-chan Mercury Rly \$2120

Mux/Matrix

HP 34508A/B/C 75 Ohm RF Mux \$1970

HP 34509A/B/C 32 Channel Relay Driver Module \$1340

HP 34510B 10-amp, 8-Channel Power Actuator \$900

HP 34511B/M 64-channel Relay Mux/Matrix \$2710

HP 34512C Switched-Shield Triaxial Matrix \$3010

HP 34513C General Purpose 50 Ohm RF Module \$3010

HP 34514C General Purpose 75 Ohm RF Module \$3325

HP 34515B 10-channel 1000 Volt Mux \$2180

HP 34516M/N 256-crosspoint Matrix \$5070

HP 34520A/B 6.5 Digit Multimeter Module \$3180

HP 34521A/B AC/DC Source Module \$3080

HP 34522A/B 32 Bit Digital I/O Module \$1555

HP 34523A/B Breadboard Module \$630

HP 34524A/B 4 Channel D/A Converter Module \$2070

HP 34530A/B Microwave Switch \$760

HP 34531A/B 1x6 Microwave Switch \$1560

# COMPUTER AIDED TEST

## Low Cost, Versatile HP-IB Switching & Control

### HP 3488A

619

- dc—26.5 GHz signal switching
- Matrix, multiplexer, & general purpose relays
- Digital I/O control & actuation

- Up to 50 channels
- 40 configuration storage registers
- 11 switch & control modules

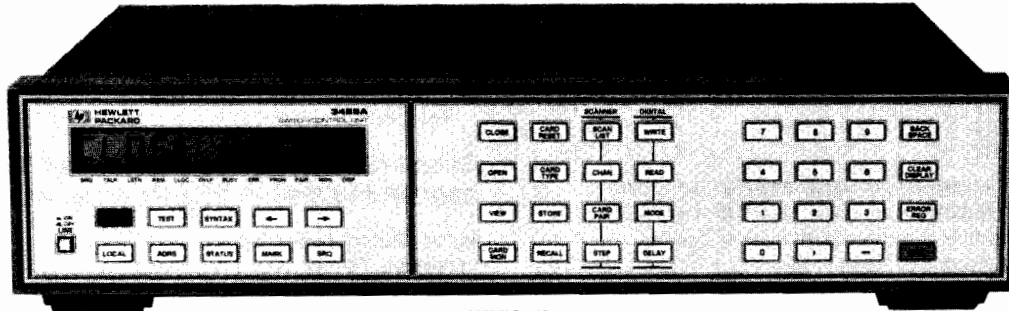

HP 3488A



### HP 3488A Switch/Control Unit

The HP 3488A Switch/Control Unit brings versatile, HP-IB programmable switching to tests requiring multi-channel measurements. The HP 3488A provides signal switching with the integrity and isolation needed for high performance test systems in production. It also offers a flexible, low cost interconnection solution for automating experiments on the bench and for development testing in the lab. The HP 3488A is designed to hold any combination of up to 5 of the following optional switch and control modules:

- 10 Channel Relay Multiplexer
- 10 Channel General Purpose Relay
- Dual 4 Channel VHF Switch
- 4 x 4 Matrix Switch
- 16 Bit Digital Input/Output
- Breadboard
- 3 Channel 18 GHz Switch
- 7 Channel Form-C Relay
- 2 Channel Microwave Switch
- 1.3 GHz 50 and 75 ohm Multiplexers

### Flexible Switching

The HP 3488A offers an economical approach to switching flexibility through plug-in modules. The user can select the right combination of switching functions to meet both performance and budget requirements. Testing is simplified by having one solution for connections of low level DVM inputs, high level dc and ac power, and microwave signals to 26.5 GHz. Additional devices such as microwave relays and programmable attenuators are easily controlled with digital I/O functions. Custom circuitry can also be implemented on breadboard modules.

### Versatile Performance

The HP 3488A can store up to 40 complete switch configurations for convenient recall in automated test programs. Switch operation can be with multiple relay closures or with selectable channels in a break-before-make mode. Break-before-make closures and recallable complete switch configurations can be combined in a programmable scan list. The HP 3488A uses removable screw terminal connectors that provide easily interchangeable wiring configurations for each test. Built-in self-test capability assures proper operation.

### Multiplexer (Opt. 010/HP 44470A)

Option 010 is a 10 channel multiplexer for scanning or multiple signal connections. Channels switch 2 wires (Hi & Lo) with 2PST relays for DVM inputs and other signals up to 250 V and 2A. This module can also be used to multiplex signals to other switching functions such as the matrix module.

### General Purpose Relay (Opt. 011/HP 44471A)

This module consists of 10 SPST independent relays for general signal switching and control of external devices. The quality connections provided make this module ideal for switching signals when multiplexing isn't required or for supplying switchable power to the device under test.

### VHF Switch (Opt. 012/HP 44472A)

The VHF module provides broadband switching capability for high frequency and pulse signals. The 2 independent groups of bidirectional 1 x 4 switches can be used for signals from dc to 300 MHz. All channels have 50 ohm characteristic impedance and are break-before-make within a group of 4 channels. Each group is isolated from the other and from ground to prevent ground loops. Excellent isolation makes this module ideal for high frequency signal analyzer measurements requiring a large dynamic range.

### Matrix Switch (Opt. 013/HP 44473A)

Option 013 offers highly flexible switching with a 4 x 4, 2 wire matrix. Any combination of 4 input channels may be connected to any combination of 4 output channels. Each cross point or node in the matrix uses a 2PST relay to switch 2 lines (Hi & Lo) at a time. Multiple 4 x 4 modules can be connected to form larger matrices. Multiplexers can be used in conjunction with this module to effectively expand the number of inputs and outputs of the matrix.

### Digital I/O (Opt. 014/HP 44474A)

This module offers 16 very flexible bidirectional I/O lines and 4 TTL compatible handshake lines for sensing and control of external devices. The digital inputs can be used to sense contact closures to ground. Each channel provides current sinks for remote switching of external relays such as the HP 33311 series of coaxial switches.

### Breadboard (Opt. 015/HP 44475A)

The breadboard module provides a convenient way to implement custom circuits and special functions that interface directly with the HP 3488A's backplane control signals.

### Microwave Switch (Opt. 016/HP 44476A)

This microwave switch furnishes three independent SPST 50-ohm coaxial switches with excellent performance from DC to 18 GHz. The 3-mm SMA connector allows the user to easily connect cables for multiple system configurations.

### Form-C Relay (Opt. 017/HP 44477A)

This module provides seven separate SPDT channels for general purpose switching and control of external devices. Using a power supply, the module can drive programmable attenuators and non-HP coaxial switches.

# COMPUTER AIDED TEST

## Low Cost, Versatile HP-IB Switching & Control (cont'd)

HP 3488A

### Microwave Switch (Opt. 018/HP 44476B)

The module brings multi-port 50-ohm coaxial switching to your test system. The module can mount any two HP 3331XX Coaxial Switches. The HP coaxial relays come in three-, four-, and five-port configurations, different switches for a variety of applications. HP Coaxial Switches that can be used are listed on the following table.

HP Coaxial Switch	Port	Frequency
HP 33311B/Opt.011	3	dc - 18 GHz
HP 33311C/Opt.011	3	dc - 26.5 GHz
HP 33312B/Opt.011	4	dc - 18 GHz
HP 33312C/Opt.011	4	dc - 26.5 GHz
HP 33313B/Opt.011	5	dc - 18 GHz
HP 33313C/Opt.011	5	dc - 26.5 GHz

### 1.3 GHz 50 ohm Multiplexer (Opt. 019/HP 44478A)

### 1.3 GHz 75 ohm Multiplexer (Opt. 020/HP 44478B)

These modules bring bi-directional switching of signals from DC to 1.3 GHz, with high channel isolation (>55 dB @ 1 GHz). Each module consists of two groups of 1x4 multiplexers. All test connections are made to BNC's on the module's edge. Off-channels can be resistively terminated.

### Specifications for Opt. 010/HP 44470A Multiplexer, Opt. 011/HP 44471A General Purpose Relay, and Opt. 013/HP 44473A Matrix Switch and Opt. 017/HP 44477A Form-C Relay Switch Modules

#### Input Characteristics

**Maximum voltage (terminal-terminal or terminal-chassis):** 250 V dc, 250 Vac rms, 350 Vac peak

**Maximum current:** 2A dc, 2A ac rms

**Maximum power:** 60 W dc, 500 VA ac

**Thermal offset:** < 3  $\mu$ V

#### DC Isolation (40°C, 60% RH)

**Channel-channel, open channel:** > 10<sup>11</sup>  $\Omega$

#### AC Isolation/Performance

(50 $\Omega$ termination)	100 kHz	1 MHz	10 MHz
Insertion Loss (dB)	<0.30	<0.35	<0.90
Crosstalk (dB)	<-73	<-53	<-33

### Specifications For Opt. 012/HP 44472A VHF Switch Module

#### Input Characteristics

##### Maximum Voltage

Center-center, center-low: 250 Vdc, 30 Vac rms, 42 Vac Peak

Low-chassis, low-low: 42 V dc

**Maximum current (per channel):** 30 mA dc, 300 mA ac rms

**Thermal offset:** < 15  $\mu$ V per channel

**Characteristic impedance:** 50  $\Omega$

#### AC Isolation/Performance

	30 MHz	100 MHz	300 MHz
Crosstalk (dB) Chan-Chan	<-100	<-85	<-65
Group-Group	<-85	<-50	
Insertion Loss (dB)	<0.5	<0.75	<1.25
VSWR	<1.06	<1.12	<1.43

All channels break-before-make within a group of 4 channels.

### Specifications for Opt. 014/HP 44474A

#### Digital I/O Module

##### I/O Lines

**Maximum voltage** = +30 Vdc (line-chassis)

**Output characteristics:** V (high)  $\geq$  2.4 V; V (low)  $\leq$  0.4V

**I (low) maximum** = 125 mA @ V (low)  $\leq$  1.25 V; fused at 250 mA.

**Input characteristics:** V (high)  $\geq$  2 V; V (low)  $\leq$  0.8 V

**External increment:** advances HP 3488A to next programmed configuration on falling edge of TTL pulse.

**Channel closed:** indicates completion of new configuration; TTL pulse.

### Specifications for Opt. 016/HP 44476A

#### Microwave Switch Module

**Frequency Range:** dc to 18 GHz

**Isolation:** >90 dB

**Impedance:** 50 Ohms

**Insertion Loss:** <0.05 dB

**SWR:** 1.40

### Specifications for Opt. 018/HP 44476B

#### Microwave Switch Module

Refer to HP 3331XX specifications.

### Specifications for Opt. 019/HP 44478A and Opt. 020/HP 44478B 1.3 GHz Multiplexers

#### Input Characteristics

**Maximum Voltage:** 42V DC + AC Peak

**Maximum Current per channel:** 1 A DC or AC RMS

**Maximum Power per channel:** 24W, 24VA, or 44 dBm

**Impedance:** 50 ohms (Opt. 019/HP 44478A)

75 ohms (Opt. 020/HP 44478B)

#### AC Performance

	$\leq$ 10 MHz	$\leq$ 100 MHz	$\leq$ 500 MHz	$\leq$ 1.3 GHz
Insertion Loss (dB) $\leq$ (40°C, 95% RH)	<0.3	<0.7	<1.5	<3.0
$\leq$ (25°C, 40% RH), (Typ.)	<0.2	<0.5	<1.1	<1.9
Crosstalk (dB) <sup>1</sup> Channel-Channel Channel-Common	<-90	<-80	<-65	<-55
Group-Group, Module-Module	<-90	<-80	<-70	<-60
VSWR	<1.2	<1.25	<1.35	<1.55

### General Specifications

#### Environmental

Temperature: 0 to 55°C; humidity: 95%, 0 to 40°C

**Power:** 86-132 V/195-250 V, switch selectable; 48 - 440 Hz; 18 VA.

**Interface:** GP-IB

**Size:** 89 H (without feet) x 425 W x 292 mm D (3.5" x 16.75" x 11.5"). Allow 76 mm (3") additional depth for wiring.

**Weight:** net: 8.5 kg (18.5 lb). Shipping: 16 kg (36.5 lb).

**Connectors** Removable screw terminal connector. Each terminal accepts 18-26 gauge (16-40 mils) wire, with strain relief for wiring. Option 012/HP 44472A VHF Switch: BNC connectors. Opt. 016/HP 44476A and Opt. 018/HP 44476B Microwave Switch: SMA connectors.

#### Ordering Information

HP 3488A Switch/Control Unit

**Price**

\$1,720

#### Switch Modules-Includes Terminal Connectors

Opt 010/HP 44470A 10 Channel Relay Multiplexer Module +\$485

Opt 011/HP 44471A 10 Channel General Purpose Relay Module +\$485

Opt 012/HP 44472A Dual 4 Channel VHF Switch Module +\$695

Opt 013/HP 44473A 4x4 Matrix Switch Module +\$600

Opt 014/HP 44474A 16 Bit Digital Input/Output Module +\$490

Opt 015/HP 44475A Breadboard Module +\$200

Opt 016/HP 44476A Microwave Switch Module +\$2,260

Opt 017/HP 44477A Form-C Relay Module +\$490

Opt 018/HP 44476B Microwave Switch Module +\$490

Opt 019/HP 44478A 1.3 GHz 50 ohm Mux +\$885

Opt 020/HP 44478B 1.3 GHz 75 ohm Mux +\$965

Rack Mounting and Manuals

Opt 401 Side Handle Kit (HP P/N 5061-1171) +\$50

Opt 907 Front Handle Kit (HP P/N 5061-1170) +\$60

Opt 908 Rack Flange Kit (HP P/N 5061-1168) +\$40

Opt 909 Rack Flange with Handles +\$85

(HP P/N 5061-1169)

Opt 910 Extra Operating & Service Manuals +\$90

Opt W30 Three Year Hardware Support +\$60

- Two mainframe sizes (Series B and Series C)
- Over thirty-five modules available
- SCPI language for easy programming
- HP Interactive Test Generator (HP ITG) Software

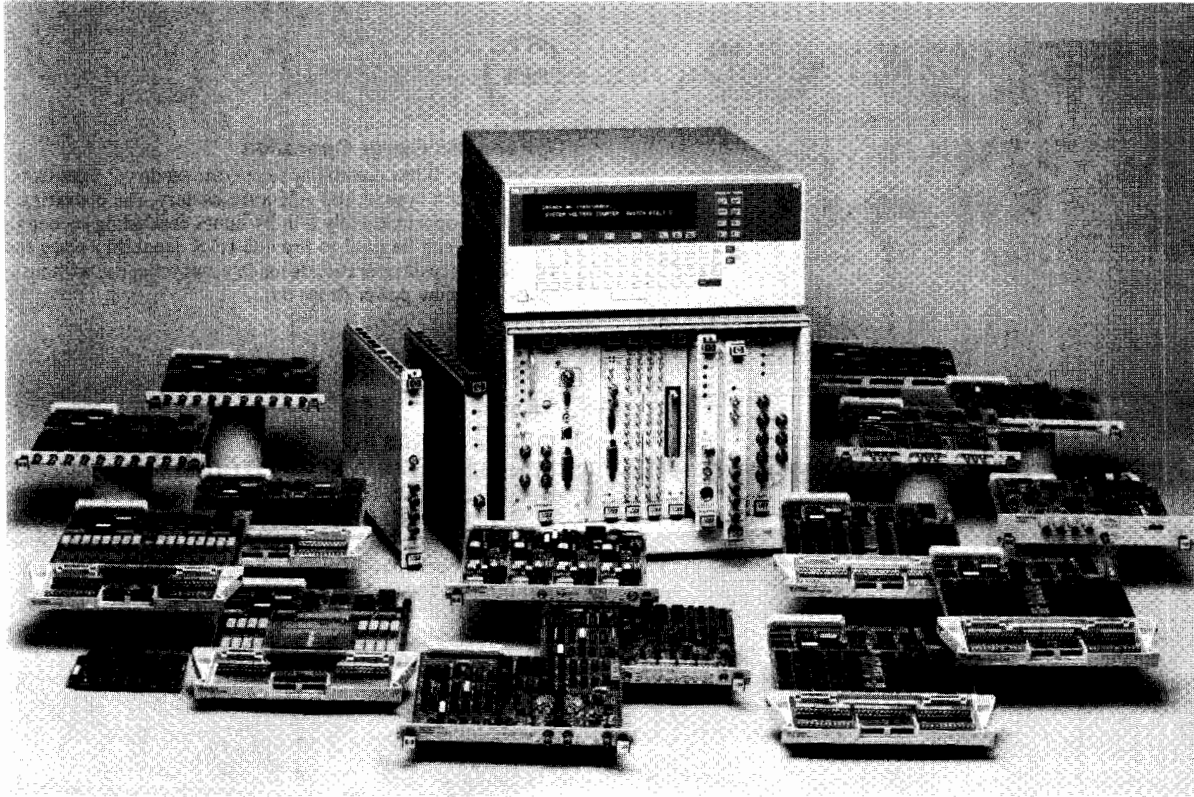

HP 75000 Family

Supported by  
**HP ITG**  
Software

### HP 75000 Family Reduces Test System Development Time

The HP 75000 family of VXIbus products is part of the HP measurement-systems architecture (MSA), which provides benefits such as standardization, downsizing, throughput, and flexibility. Developing a test system involves much more than simply selecting hardware; it also requires software, systems integration, and support. The HP 75000 family is a fully compatible line of VXI products that reduces the development time for test systems. It includes computers, software, standardized instrument language, reliability, and services.

#### Hardware

The HP 75000 family of VXIbus products consists of two mainframe sizes and over thirty-five modules. The HP 75000 Series B Mainframes are designed for low-cost computer-aided-test applications, and include seven B-size VXI slots. The HP 75000 Series C Mainframe is designed for medium-to-high performance computer-aided-test applications, and includes thirteen C-size VXI slots. A broad line of HP 75000 B- and C-size modules such as switching, digital multimeters, counters, sources, power meters, and computers are also available.

#### Firmware and Software

The HP 75000 products offer compatibility and a broad range of price-performance. All members of the HP 75000 family use the Standard Commands for Programmable Instruments (SCPI) language (formerly TMSL), a new industry standard programming language to simplify programming. With SCPI, users can send commands to instruments in a consistent, readable form. It conforms to IEEE 488.2. For example, to trigger a reading, you would send the command `"*TRG"` to the appropriate instrument. All HP 75000

family products support the HP Interactive Test Generator (HP ITG) interface. Hewlett-Packard added these capabilities to the VXI standard to help reduce test system development time.

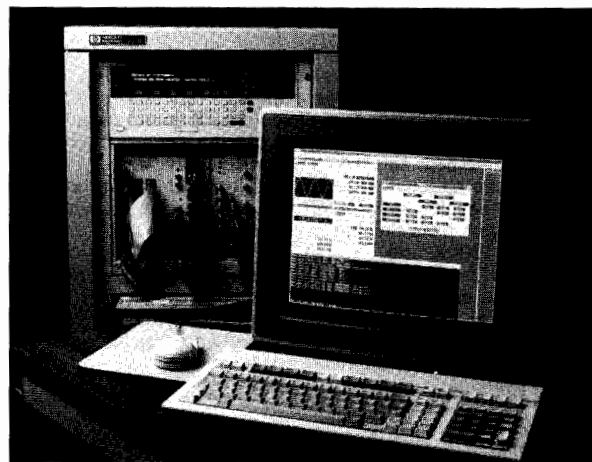

Developing Programs with HP Interactive Test Generator

#### System Support

Because getting a test system running quickly requires a solid base of support, Hewlett-Packard offers support services tailored to user needs. Support services in the U.S. include free 90-day phone-in support and optional 1 year additional support contracts. All HP 75000 Products have a standard 3-year warranty.

# COMPUTER AIDED TEST

## HP 75000 Family of VXI Products

### Series B and Series C Mainframes

#### Series B Mainframes

- Low-cost switching and measurement
- Built in command module (no slot 0 required)
- Flexible, built-in pacer for timing external devices
- SCPI systems language eases programming

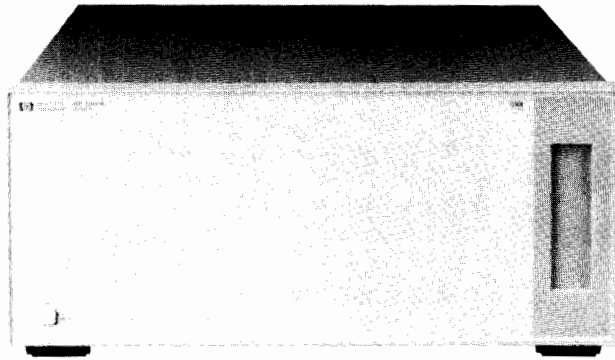
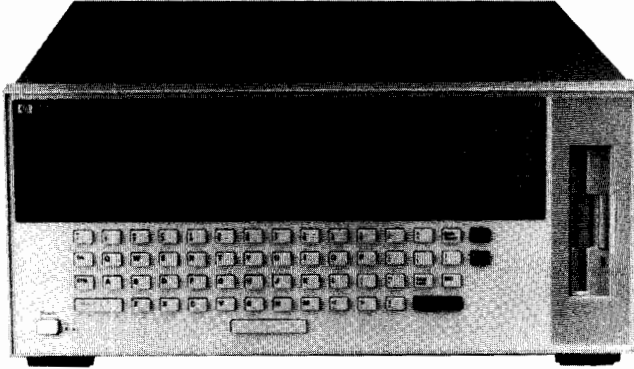

HP 75000 Series B Mainframes

Supported by  
**HP ITG**  
Software

#### Series B Mainframes

The HP 75000 Series B mainframes provide a flexible, low-cost test system platform. Both include a built-in command module, eliminating the need for Slot 0 and resource manager functions, and providing an HP-IB (IEEE-488) interface. The Series B mainframes have 7 B-size and 3 A-size slots. To configure a test system, you plug in the individual instrument and switching modules you want. (The digital multimeter can optionally be mounted inside the mainframe.) The built-in pacer can generate timing and synchronizing signals by sending a TTL signal from the rear panel connector.

The HP E1300A and E1301A mainframes are identical except that the E1301A also includes a front-panel keyboard/display for direct command entry to troubleshoot wiring, connections, and programming. Use the HP E1300A (plain front panel) with turnkey software, such as HP 75000 System 10 software (see page 584), or to further lower the cost of duplicate systems.



#### Optional Internal Disk Drives

When the HP IBASIC controller is installed in a Series B mainframe, you can also add the Option 005, 3-1/2 inch flexible disk drive and/or the Option 006, 20 Mbyte hard disk drive. These ruggedized drives provide storage for programs and data, and they provide auto-start routines. Both disk drives can be field-installed later. The 3-1/2 inch flexible drive supports 256 Kbyte, 720 Kbyte, and 1.4 Mbyte disks. Both LIF and DOS formats are recognized automatically.

#### Series C Mainframe

- High-performance computer aided test
- Auto-configuring backplane
- Pressurized air channel for independent slot cooling
- Ultra-reliable power supply



#### Optional dc Power Operation

The Series B has the ability to operate on dc voltages from 10 to 30 Volts. Using a typical 100 AH auto battery, the operating time can range from approximately 6 to 24 hours depending on configuration. This option can be used to provide UPS capability since the switch-over from ac to dc operation is made automatically, without resetting, whenever the ac power drops out.



#### Optional RS-232 Ports

The HP E1324A RS-232C/422 Data Comm Module (A-size) gives you the ability to control additional RS-232 peripherals at up to 19200 baud or communicate over longer distances with RS-422. The internal 8 Kbyte buffer reduces computer overhead for managing communications handshaking. Setup is easy with programmable baud rate, parity, and handshaking protocol.

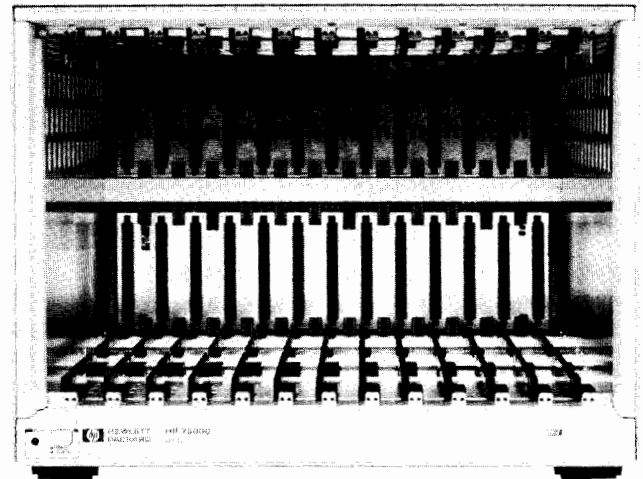

HP 75000 Series C Mainframe

Supported by  
**HP ITG**  
Software

#### Series C Mainframe

The HP 75000 Series C Mainframe provides high-performance while allowing for system downsizing. The Series C mainframe has thirteen C-size VXI slots. It offers a high-performance platform that becomes the heart of the computer-aided-test system.

With the exclusive HP auto-configuring backplane, all you have to do is plug in a module, and the backplane does the rest. There is no need for jumpers or dip switches to bypass empty slots.

The new HP power supply has a proven track record of greater than 1 million hours MTBF. It also has a third fan to provide up to 45 watts per slot cooling.

With the exclusive HP pressurized air channel system, each slot is cooled independently. A pressurized plenum with channels delivers air to each slot, and ensures adequate cooling with empty slots, with or without faceplates.

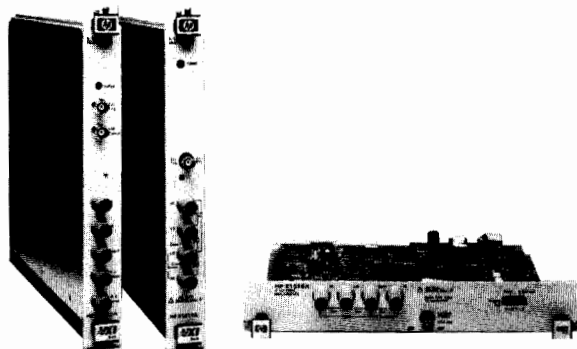

HP E1410A, HP E1411B and HP E1326B

### 5 1/2-Digit Multimeters (HP E1326B, E1411B)

The HP E1326B and E1411B 5 1/2-digit multimeters are well suited for data acquisition and computer-aided testing. These economical, versatile multimeters meet both high accuracy scanning and high speed measurement needs.

These two multimeters differ only in size; they are identical in electrical design. The HP E1326B multimeter is a 2-slot B-size module that can be plugged into the rear of the HP 75000 Series B Mainframe or mounted internally (saving two module slots) with the internal installation kit (HP E1326-80002). The HP E1411B multimeter is a 1-slot C-size module.

- Dual A/Ds
  - 5 1/2-digit/low noise integrating A/D
  - high speed (14 kHz) sampling A/D
- Balanced differential isolated inputs
- Functions: DCV, ACV, 2 & 4-wire ohms, offset compensated ohms, thermocouples, thermistors, RTDs
- Autozeroing and autoranging
- Flexible triggering with built-in timer/pacer
- Software calibration

Use the integrating A/Ds in these multimeters to make 5 1/2-digit, low-noise measurements. Use the sampling A/Ds to make 14-bit readings at rates up to 14 kHz. The multimeters can be combined with any HP 75000 low-frequency multiplexer to create a multichannel scanning multimeter. A single SCPI command from the Series B Mainframe or HP E1405A Command Module can program both the multimeter and multiplexer channels.

### Reading Rates & Resolution

Conditions: Auto zero off, fixed range, default trigger delay, sample source 'TIMER' for rates > 15 readings/s.

Aperture:	320/267 ms	20/16.7 ms	2.5 ms	100 $\mu$ s	10 $\mu$ s
Typical Reading rates (rdgs/sec)					
DCV/ $\Omega$	3/3.5	49/59	365	3125	13,000
ACV	1.3	1.9	1.9	1.9	1.9
Resolution					
Bits	$\pm 22$	$\pm 20$	$\pm 18$	$\pm 15$	$\pm 14$
Digits	6 1/2	6	5 1/2	4 1/2	3 1/2

### Noise Rejection

Conditions: 50/60 Hz  $\pm 0.1\%$ , 1 k $\Omega$  in both HIGH and LOW leads with 10% imbalance, LOW connected to COMMON at source. Measured with respect to earth ground.

Aperture:	320/267 ms	20/16.7 ms	2.5 ms	100 $\mu$ s	10 $\mu$ s
NPLCs	16	1	NA	NA	NA
NMR	84 dB	60 dB	0	0	0
DC CMR	150 dB	150 dB	150 dB	150 dB	150 dB

### 90-Day dc Voltage Accuracy

$\pm$ (% of reading + volts)

Conditions: Autozero on, 1 hour warm up within  $\pm 5$  degrees C of cal temp.

Aperture:	320/267 ms	20/16.7 ms	2.5 ms	100 $\mu$ s	10 $\mu$ s
Range					
125mV	.023%+5.0 $\mu$ V	.023%+5.0 $\mu$ V	.023% +10. $\mu$ V	.065%+30. $\mu$ V	.115%+60. $\mu$ V
1V	.013%+10. $\mu$ V	.013%+15. $\mu$ V	.013%+15. $\mu$ V	.055%+100 $\mu$ V	.100%+200 $\mu$ V
8V	.010%+50. $\mu$ V	.010%+50. $\mu$ V	.010%+80. $\mu$ V	.055%+750 $\mu$ V	.100%+1.5mV
64V	.015%+1.0 mV	.015%+1.0 mV	.015%+1.0 mV	.055%+5.0 mV	.100%+20. mV
300V	.015%+5.0 mV	.015%+5.0 mV	.015%+5.0 mV	.055%+30. mV	.100%+80.mV

### 6 1/2-Digit Multimeter (HP E1410A)

The HP E1410A 6 1/2-Digit Multimeter is a full function system DMM in a compact, single-slot C-size module. It is similar in design to the popular HP 3457A multimeter, and it is suitable for a wide variety of computer aided and manufacturing test applications where high accuracy is required.

Programming this message-based multimeter is easy with high-level SCPI commands. The command set is built into the voltmeter module. Make all high accuracy multimeter measurements with this compact system DMM.

- High accuracy/low noise 6 1/2-digit integrating A/D
- 1,450 readings/second at 3 1/2-digits
- Guarded high impedance inputs
- Functions: DCV, ACV (DC & AC coupled), 2 & 4-wire ohms, offset compensated ohms, frequency, period
- Autozeroing and autoranging
- Flexible triggering with built-in timer/pacer
- Software calibration

### Reading Rates & Resolution

Conditions: Auto zero off, fixed range, delay  $\emptyset$ , ac slow filter on, offset compensation off

Aperture:	200/167ms	20/16.7ms	2/1.67ms	100 $\mu$ s	10 $\mu$ s
Reading rates (rdgs/sec)					
DCV/ $\Omega$	4	47	312	1250	1450
ACV	.65	1.0	1.0	1.0	1.0
Resolution					
Bits	$\pm 22$	$\pm 22$	$\pm 19$	$\pm 15$	$\pm 12$
Digits	6 1/2	6 1/2	5 1/2	4 1/2	3 1/2

### Noise Rejection

Conditions: 50/60 Hz  $\pm .08\%$ , 1 k $\Omega$  imbalance in low lead.

Aperture:	200/167ms	20/16.7ms	2/1.67ms	100 $\mu$ s	10 $\mu$ s
NPLCs	10	1	NA	NA	NA
NMR	80 dB	60 dB	0	0	0
DC CMR	140 dB	140 dB	140 dB	140 dB	140 dB

### 90-Day dc Voltage Accuracy

$\pm$ (% of reading + volts)

Conditions: Autozero on, within  $\pm 5$  degrees C of cal temp., 1 hour warmup

Aperture:	200/167 ms	20/16.7 ms	2/1.67 ms	100 $\mu$ s	10 $\mu$ s
Range					
30 mV	.0053%+5.6 $\mu$ V	.0053%+6.75 $\mu$ V	.0053%+8.8 $\mu$ V	.0053%+21 $\mu$ V	.0053%+70 $\mu$ V
300 mV	.0038%+5.8 $\mu$ V	.0038%+6.8 $\mu$ V	.0038%+11 $\mu$ V	.0038%+50 $\mu$ V	.0038%+400 $\mu$ V
3V	.0030%+9.0 $\mu$ V	.0030%+9.0 $\mu$ V	.0030%+50 $\mu$ V	.0030%+400 $\mu$ V	.0030%+4 mV
30V	.0048%+230 $\mu$ V	.0048%+330 $\mu$ V	.0048%+800 $\mu$ V	.0048%+4 mV	.0048%+40 mV
300V	.0063%+800 $\mu$ V	.0063%+800 $\mu$ V	.0063%+4 mV	.0063%+40 mV	.0063%+400 mV

# COMPUTER AIDED TEST

## HP 75000 Family Of VXI Products

### Counters

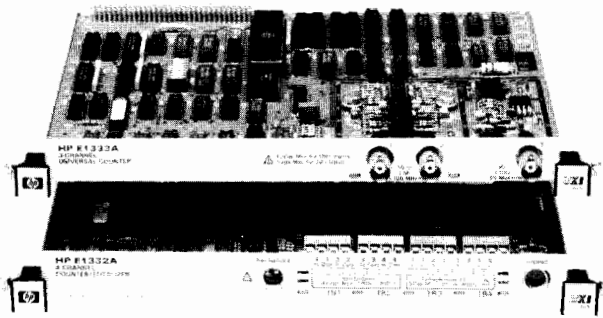

HP E1333A and HP E1332A



### 3-Channel Universal Counter (HP E1333A)

- Frequency, period average, ratio, pulse width, time interval and totalize to 100 MHz
- 1 GHz frequency measurement available on channel 3
- Occupies only one B-size slot
- 1 ns time interval resolution with averaging
- Features SCPI (equivalent to TMSL) command language and ITG panels when used with the HP 75000 Series B mainframe or HP E1405A command module

#### Specifications

##### Frequency measurement

**Range:** 100 MHz (channels 1 and 2)  
75 MHz - 1 GHz (channel 3)

**Resolution:**  $1/(\text{Gate time})$  (Gate time:  $2^n$  n ms,  $n = 1$  to 16)

**Accuracy:**  $\pm$  resolution  $\pm$  timebase error  $\pm$  trigger noise error

**Period average measurement:** Channels 1 and 2 average  $2^N$  periods of the input signal.

**Range of N:** 1 to 16

**Resolution:**  $1/(10 \times 10^6 \times 2^N)$  seconds

**Accuracy:**  $\pm$  resolution  $\pm$  time base error  $\pm$  trigger noise error

##### Time interval (with average mode)

**Range:** Up to  $6871/(2^N)$  seconds (where  $2^N$  is the number of intervals to be averaged,  $N = 0$  to 7)

**Resolution:**  $(100 \text{ ns})/(2^N)$  (where  $2^N$  is the number of intervals to be averaged,  $N = 0$  to 7)

**Accuracy:**  $\pm$  resolution  $\pm$  time base error  $\pm$  trigger noise error

##### Pulse width (with average mode)

**Range:** up to  $6871/(2^N)$  seconds (where  $2^N$  is the number of intervals to be measured,  $N = 0$  to 7)

**Resolution:**  $100 \text{ ns}/2^N$

**Accuracy:**  $\pm$  resolution  $\pm$  time base error  $\pm$  trigger noise error

##### Frequency ratio

**Resolution:**  $1/(2^N)$  ( $2^N$  is the preset number of transitions,  $N = 6$  to 36)

##### Totalizing

**Range:** 1 to  $2^{36} - 1$

##### Time base

**Frequency:** 10 MHz

**Accuracy:**  $\pm 2$  ppm

**Temperature drift:**  $\pm 5$  ppm (0-50°C)

**Aging:**  $\pm 2$  ppm/year

##### Trigger noise error (RMS) =

$\sqrt{(80 \mu\text{V})^2 + (en)^2}/(\text{input slew rate at trigger point in } \mu\text{V/s})$   
where  $en$  = noise on input signal for 150 MHz bandwidth in  $\mu\text{V}$

### 4-Channel Counter/Totalizer (HP E1332A)

- Totalize, up/down count, gated totalize, pulse width, time interval, period average, and frequency measurement up to 4 MHz
- Programmable direct or isolated inputs
- Programmable digital input filter
- Features SCPI (equivalent to TMSL) command language and ITG panels when used with the HP 75000 Series B mainframe or HP E1405A command module

#### Specifications

##### Frequency measurement (requires 2 channels)

**Range:** 4 MHz

**Resolution:**  $1/(\text{Gate time})$  (Gate time:  $2^n$  n ms,  $n = 1$  to 16)

**Accuracy:**  $\pm$  resolution  $\pm$  time base error  $\pm$  trigger noise error

**Period measurement (requires 2 channels):** Channels 1 and 3 measure  $2^N$  periods of the input signal.

**Range of N:** 1 to 16

**Resolution:**  $1/(5 \times 10^6 \times 2^N)$  seconds

**Accuracy:**  $\pm$  resolution  $\pm$  time base error  $\pm$  trigger noise error

##### Time interval

Measures the time interval between transition from channel 1 to channel 2 or channel 3 to channel 4.

**Range:** Up to 858 seconds

**Resolution:** 200 ns

**Accuracy:**  $\pm$  resolution  $\pm$  time base error  $\pm$  trigger noise error

##### Pulse width (requires 2 channels)

**Range:** Up to 858 seconds

**Resolution:** 200 ns

**Accuracy:**  $\pm$  resolution  $\pm$  time base error  $\pm$  trigger noise error

##### Totalizing (requires 1 channel)

**Range:** 1 to  $2^{32} - 1$  counts

##### Gated totalize (requires 2 channels)

**Range:** 1 to  $2^{16} - 1$

##### Up/down count (requires 2 channels)

**Range:**  $\pm (2^{31} - 1)$

##### Time base

**Frequency:** 5 MHz

**Accuracy:**  $\pm 2$  ppm

**Temperature drift:**  $\pm 5$  ppm (0-50°C)

**Aging:**  $\pm 2$  ppm/year

##### Trigger noise error (RMS) =

$\sqrt{(200 \mu\text{V})^2 + (en)^2}/(\text{input slew rate in } \mu\text{V/s})$  where  $en$  = noise on input signal for 5 MHz bandwidth in  $\mu\text{V}$



HP E1420A

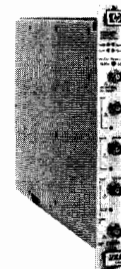

### High-Performance Universal Counter (HP E1420A)

The HP E1420A universal counter offers the same exceptional performance as Hewlett Packard's high-performance rack-and-stack universal counters.

- Full universal counter functionality
- 200 MHz frequency range with 9 digits/second resolution and optional high-frequency channel
- 2 ns time interval resolution
- High measurement throughput
- Optional TCX0 time base with output for driving system clock (CLK10)
- Measurement synchronized to VXIbus or external trigger
- Message-based
- 1 slot, C-size

#### Specifications

**Frequency range:** .001 Hz to 200 MHz, high-frequency channel optional

**Frequency resolution:** 9 digits in 1 second of measurement time

**Period range:** 5 ns to 1000s

**Period resolution:** same as frequency

**Time interval (TI) range:** -1 ns to  $10^3$  s (single-shot)  
-1 ns to 10 s (averaging)

**Time interval (TI) resolution:** 2 ns single-shot, 200 ps averaging



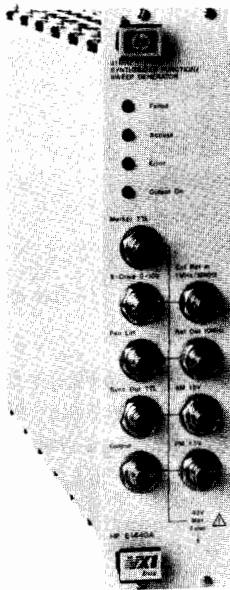

Supported by  
**HP ITG**  
Software

HP E1440A

### 21 MHz Synthesized Function/Sweep Generator (E1440A)

The HP E1440A 21 MHz Synthesized Function/Sweep Generator is a 2-slot C-size VXI module that offers five different waveforms with synthesizer accuracy. Frequency resolution down to 1  $\mu$ Hz, 5 ppm frequency accuracy/stability and outstanding signal purity make this generator the ideal reference source for test equipment. Includes multi-interval sweep and multi-marker mode sweep capabilities.

#### Specifications

**Waveforms:** sine, square, triangle, negative and positive ramps, dc, TTL clock

**Frequency ranges:** sine: 1  $\mu$ Hz - 21 MHz  
square: 1  $\mu$ Hz - 11 MHz  
triangle/ramps: 1  $\mu$ Hz - 11 kHz  
TTL clock: 1  $\mu$ Hz - 60 MHz

**Frequency resolution:** 11 digits

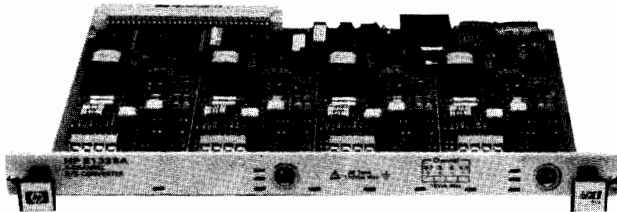

HP E1328A

Supported by \*  
**HP ITG**  
Software

### 4-Channel D/A Converter (E1328A)

The HP E1328A 4-channel D/A converter is a B-size VXI module that provides four independent, isolated channels of voltage or current output. Each channel is individually selectable for maximum flexibility. Software calibration is provided, eliminating the need to adjust pots.

#### Specifications

**Voltage output range:**  $\pm 10.92$  V

**Voltage accuracy:** 24-hour:  $\pm(0.05\% + 3.3$  mV)  
90-day:  $\pm(0.15\% + 29$  mV)

**Current output range:**  $\pm 21.8$  mA

**Current accuracy:** 24-hour:  $\pm(0.05\% + 7$   $\mu$ A)  
90-day:  $\pm(0.15\% + 59$   $\mu$ A)

**Settling time:** 750  $\mu$ s

**Isolation:** 120 VRMS, 170 Vdc/ac peak

**Programmable resolution:** 333  $\mu$ V/667 nA

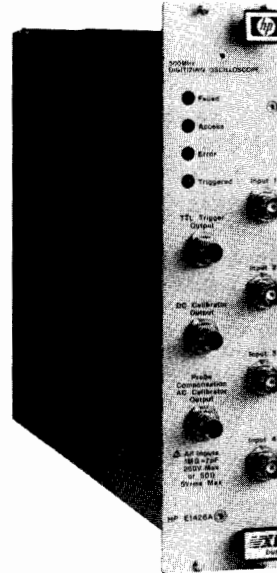

Supported by  
**HP ITG**  
Software



HP E1426A

### 500 MHz Digitizing Oscilloscope (HP E1426A)

The HP E1426A 500 MHz digitizing oscilloscope is a full-function digitizing oscilloscope that is similar in design to the HP 54503A oscilloscope. High precision and advanced triggering enables very repeatable and accurate measurements on simple or complex waveforms.

- HP 54503A equivalent (see page 61)
- 500 MHz bandwidth
- 4 channels
- 8-bit vertical resolution
- 20 MSa/s digitizing rate
- Message-based module (send high-level, ASCII SCPI (TMSL) commands)
- 2-slot, C-size

#### Specifications

**Bandwidth:** dc to 500 MHz ( $-3$ dB, dc-coupled)

**Max sample rate:** 20 MSa/s

**Number of inputs:** 4 (Simultaneous acquisition on two inputs are used; data is alternately acquired by inputs.)

**Vertical sensitivity range:** 1 mV/div to 5 V/div

**Time base range:** 200 ps/div to 5 s/div

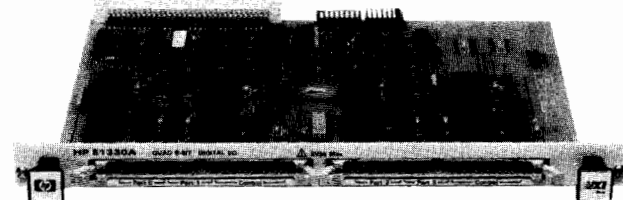

HP E1330A

Supported by \*  
**HP ITG**  
Software

### Quad 8-Bit Digital Input/Output (E1330A)

The HP E1330A digital I/O is a B-size VXI module that provides digital interfacing to special-purpose circuitry or external devices. Each block has dedicated control and handshake lines. The E1330A supports standard GPIO protocols and different data formats such as decimal, hexadecimal, octal and binary.

#### Specifications

**Data lines:** 4 sets of 8 bidirectional lines, TTL compatible, jumper selectable pullups

**Handshake lines:** 4 sets of 3 lines each; Input/Output Status, Control and Flag

**Handshake modes:** None, Leading Edge, Trailing Edge, Partial, Pulse & Strobe

\*When used with HP 75000 Series B or HP E1405A command module.

# COMPUTER AIDED TEST

## HP 75000 Family of VXI Products

### Switches, Multiplexers, Matrixes

Supported by\*  
**HP ITG**  
Software

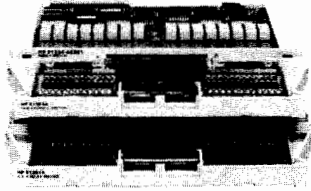

HP E1361A and HP E1364A

#### 4 x 4 Matrix Switch (HP E1361A)

The HP E1361A 4x4 matrix switch is a B-size VXI module that provides the highly flexible 4x4 matrix switching capability required by many test systems to connect several instruments at once to several points on a unit under test. Each crosspoint switches two wires with low differential offsets. Larger matrixes such as 4x8 or 4x12 can be formed by linking multiple 4x4 modules.

#### Specifications

**Maximum input voltage:** 250 V dc or ac rms

**Maximum input current:** 1 A dc or ac rms

**Maximum input power:** 40 watts or 40 VA

**Thermal offset:** < 7  $\mu$ V per contact

**Bandwidth:** -3 dB @ 10 MHz

**Crosstalk (Ch to Ch):** <-80 db @  $\leq$ 100 kHz  
<-30 db @  $\leq$ 10 MHz

#### 16-Channel Form C Switch (HP E1364A)

The HP E1364A 16-channel form C switch is a B-size VXI module that consists of 16 independent form C relays, allowing a wide variety of devices and signals to be switched. Each channel has Common, Normally Open and Normally Closed terminals for easy configuration. Power up and down states can be chosen because the relays are latching.

#### Specifications

**Maximum input voltage:** 250 V dc or ac rms

**Maximum input current:** 1 A dc or ac rms

**Maximum input power:** 40 watts or 40 VA

**Thermal offset:** < 7  $\mu$ V per contact

**Bandwidth:** -3 dB @ 10 MHz

**Crosstalk (Ch to Ch):** <-80 db @  $\leq$ 100 kHz  
<-30 db @  $\leq$ 10 MHz

Supported by\*  
**HP ITG**  
Software

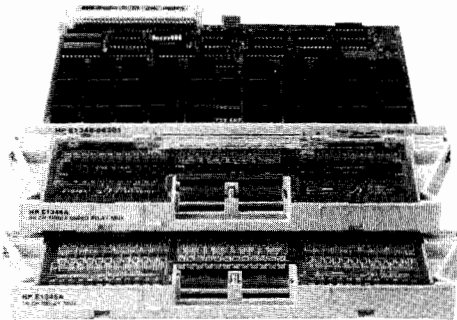

HP E1345A, E1346A

#### 16-Channel Relay Multiplexer and 48-Channel Single-Ended Relay Multiplexer (HP E1345A & E1346A)

The HP E1345A and E1346A relay multiplexers connect multiple analog signals to a DMM or other instrument. The HP E1345A switches three wires per channel with signals up to 170V peak. The HP E1346A switches one wire per channel and is designed for applications needing a large number of channels where all the signals have a common ground. Both modules feature a removable terminal module for easy wiring.

#### Specifications

**Maximum input voltage:** 120V dc, 170V peak ac

**Maximum input current per channel:** 50 mA non-inductive

**Maximum power:** 1 VA rms per channel

**Maximum offset voltage per channel:** 4  $\mu$ V (HP E1345A), 50  $\mu$ V (HP E1346A)

**Bandwidth (-3db):** >10 MHz

Supported by\*  
**HP ITG**  
Software

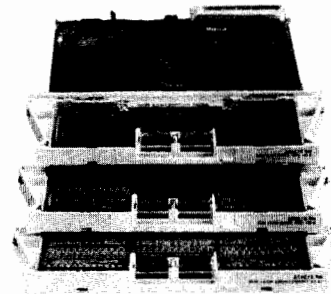

HP E1347A, E1355A, E1356A

#### 16-Channel Thermocouple Relay Multiplexer, 8-Channel 120 $\Omega$ Strain Gage Relay Multiplexer, and 8-Channel 350 $\Omega$ Strain Gage Relay Multiplexer (HP E1347A, HP 1355A, HP 1356A)

These multiplexers connect multiple analog signals to a DMM or other instrument allowing temperature and strain measurements to be made. Three wires are switched per channel with signals up to 170V peak. All three modules feature a removable terminal module for easy wiring.

- 16-channel thermocouple measurements with built-in thermistor reference junction
- 8-channel strain measurements can be made with 1/4, 1/2, and full bridge configurations

#### Specifications

**Maximum input voltage:** 120V dc, 170V peak ac

**Maximum input current per channel:** 50 mA non-inductive

**Maximum power:** 1 VA rms per channel

**Maximum offset voltage per channel:** 4  $\mu$ V

**Bandwidth (-3db):** >10 MHz

Supported by\*  
**HP ITG**  
Software

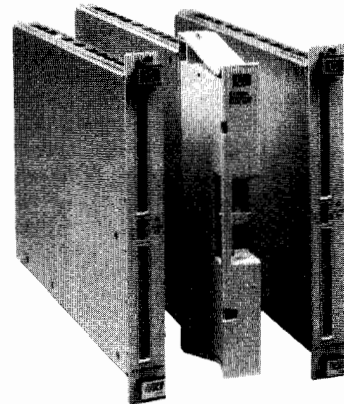

HP E1460A, E1468A, E1469A

#### 64-Channel Relay Multiplexer, 8 x 8 Matrix Switch, and 4 x 16 Matrix Switch (HP E1460A, E1468A, E1469A)

The HP E1460A 64-channel relay multiplexer is a C-size VXI module that is perfect for switching low-frequency voltage and two- and four-wire resistance signals. This module can switch either 64 two-wire or 128 one-wire channels. The HP E1468A 8 x 8 matrix switch and the HP E1469A 4 x 16 matrix switch are C-size VXI modules that provide highly flexible matrix switching capability required by many test systems to connect several instruments at once to several points on a unit under test.

#### Specifications

**Maximum input voltage:** 220 V dc, 250 V ac rms

**Maximum input current:** 1 A dc or ac rms ( $V_{max}$  < 30 V dc or rms)

**Maximum power:** 40 VA

**Maximum offset voltage:** 7  $\mu$ V

\*When used with the HP 75000 Series B or the HP E1405A Command module.

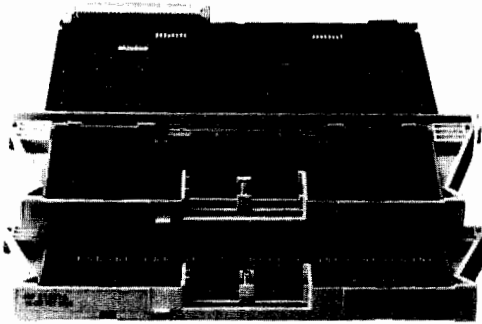
Supported by  
**HP ITG**  
Software

HP E1357A, E1352A

### 16-Channel FET Multiplexer and 48-Channel Single-Ended FET Multiplexer (HP E1351A & E1352A)

The HP E1351A and E1352A FET multiplexers connect multiple analog signals to a DMM or other instrument. The HP E1351A switches two wires per channel with the guard terminal common to all channels. The HP E1352A switches one wire per channel and is designed for applications needing a large number of channels where all the signals have a common ground. Use these multiplexers with the HP E1326A as a scanning voltmeter to achieve scanning rates of 10,000 channels/s. Both modules feature a removable terminal module for easy wiring.

#### Specifications

**Maximum input voltage:** 16 V peak

**Maximum input current per channel:** 1 mA non-inductive

**Maximum offset voltage per channel:** 25  $\mu$ V (0 to 28°C), 250  $\mu$ V (28 to 50°C)

**Closed channel resistance:** <3.1 k $\Omega$  for high or low input  
<2.1 k $\Omega$  for guard input

**Bandwidth (-3db):** 50  $\Omega$  source, 1 M $\Omega$ , termination > 200 kHz

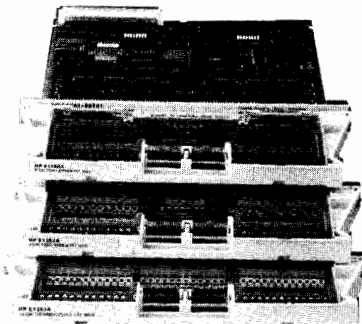
Supported by  
**HP ITG**  
Software

HP E1353A, 1357A, E1358A

### 16-Channel Thermocouple FET Multiplexer, 8-Channel 120 $\Omega$ Strain Gage FET Multiplexer, and 8-Channel 350 $\Omega$ Strain Gage FET Multiplexer (HP E1353A, HP 1357A, HP 1358A)

These multiplexers connect multiple analog signals to a DMM or other instrument allowing temperature and strain measurements to be made. Two wires are switched per channel with the guard channel common to all channels. All three modules feature a removable terminal module for easy wiring.

- Fast thermocouple measurements - up to 10,000 channels per second
- Make dynamic strain measurements up to 10,000 readings per second

#### Specifications

**Maximum input voltage:** 16 peak

**Maximum input current per channel:** 1 mA non-inductive

**Maximum offset voltage per channel:** 25  $\mu$ V (0 to 28°C), 250  $\mu$ V (28 to 50°C)

**Closed channel resistance:** <3.1 k $\Omega$  for high or low input  
<2.1 k $\Omega$  for guard input

**Bandwidth (-3db):** 50  $\Omega$  source, 1 M $\Omega$ , termination > 200 kHz

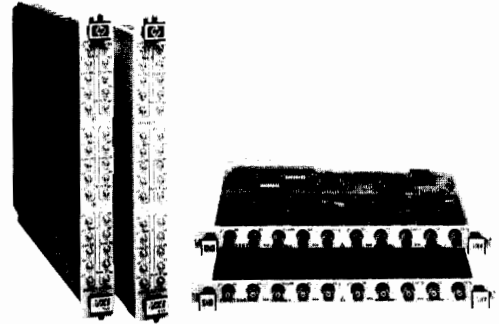
Supported by  
**HP ITG**  
Software

HP E1472A, E1473A, E1366A, E1367A

### 2x4:1 RF Multiplexers (HP E1366A & E1367A)

The HP E1366A and E1367A RF multiplexers are B-size VXI modules that provide broadband switching with two independent 1X4 multiplexers for switching signals from dc to 1.3 GHz. BNC connectors make configuration easy. These modules are identical except that the HP E1366A is 50 ohm and the HP E1367A is 75 ohm impedance.

#### Specifications

**Maximum input voltage:** 42 V peak

**Maximum input current per channel:** 1A dc or ac rms

**Maximum power per channel:** 24W or 24 VA

ac performance:	<10 MHz	<100 MHz	<1.3 GHz
Insertion loss (dB)	<0.3	<0.7	<3.0
Crosstalk (dB)	<-90	<-80	<-40
VSWR	<1.2	<1.25	<1.55

### 6x4:1 RF Multiplexers (HP E1472A & E1473A)

For larger channel 50-ohm RF switching applications, the HP E1472A and E1473A C-size VXI modules provide six independent 1X4 multiplexers for switching signals from dc to 3 GHz. Each HP E1472A multiplexer module can support up to two HP E1473A expander modules. Both modules use SMB connectors to assure high performance.

#### Specifications

**Maximum input voltage:** 42 V dc + ac peak

**Maximum input current per channel:** 1 A dc or ac rms

**Maximum power per channel:** 24W or 24 VA

ac performance:	<10 MHz	<100 MHz	<1.3 GHz	<3 GHz
Insertion loss (dB)	<.1	<.4	<1.5	<8
Crosstalk (dB)	<-90	<-80	<-50	<-20 (typ)
VSWR	<1.05	<1.15	<1.35	<1.5

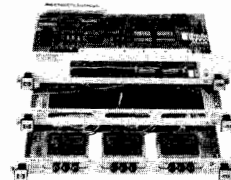
Supported by  
**HP ITG**  
Software

HP E1368A, E1369A, E1370A

### Microwave Switch and Driver (HP E1368A, E1369A, E1370A)

The HP E1368A 18 GHz microwave switch, E1369A microwave switch driver, and E1370A microwave switch/attenuator driver are B-size VXI modules that provide microwave switching and attenuator capability for test systems.

The HP E1368A has three independent SPDT 50  $\Omega$  coaxial switches with excellent performance from dc to 18 GHz. The HP E1369A allows you to mount three HP 3331xx coaxial switches for switching up to 26.5 GHz signals (switches not provided). The HP E1370A allows you to mount one HP 3336xx microwave switch or one HP 3332xx step attenuator for switching or attenuating signals up to 26.5 GHz (switches and attenuators not provided).

#### Specifications for the HP E1368A

**Frequency range:** dc to 18 GHz

**Isolation:** >90 dB

**Characteristic impedance:** 50  $\Omega$

**Insertion loss:** <0.5 dB

**VSWR:** <1.4

\*When used with the HP 75000 Series B or the HP E1405A Command Module

# COMPUTER AIDED TEST

## HP 75000 Family of VXI Products

### Power Meter, Development Tools

Supported by  
**HP ITG**  
Software

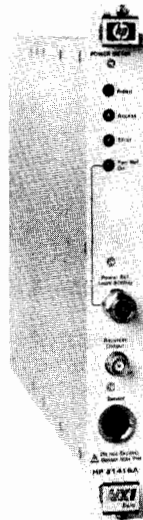

HP E1416A

#### Power Meter (HP E1416A)

The HP E1416A power meter is a full-feature, message-based, single channel average power meter. It has the capability of the popular HP 437B power meter in a single-slot C-size VXI module.

#### Features:

- High accuracy
- 100 kHz to 50 GHz
- -70 to +44 dBm

The HP E1416A power meter combines exceptional meter linearity and low sensor SWR to provide outstanding measurement accuracy in demanding situations. Instrumentation accuracy is specified to be  $\pm 0.5\%$  in linear mode or  $\pm 0.02$  dB in logarithmic mode, making instrumentation uncertainty a negligible part of total measurement error. Features include automatic calibration and zeroing, frequency (and cal factor) entry, rel, offset, selectable resolution, duty cycle, range hold setting, save/recall of meter settings, and SCPI (TMSL) compatibility for easy programming.

#### Functions

**Frequency:** allows entry of test signal frequency for Cal factor selection.

**Offset:** allows power measurement to be offset by  $\pm 99.99$  dB.

**Resolution:** selectable of 0.1, 0.01, and 0.001 dB or 1%, 0.1% and 0.01% of full scale. Auto filter mode automatically selects the required number of averages for the chosen range and resolution.

**Averaging:** selectable from 1 to 512 readings (in powers of 2).

**Duty cycle:** displays peak power representation of measured rms power for rectangular pulses.

**Sensor tables:** allows entry and editing of up to 10 frequency versus Cal Factor sensor tables.

**Save/recall states:** saves and recalls 10 complete HP E1416A operating states.

#### Specifications

**Frequency:** 100 kHz to 50 GHz, sensor-dependent

**Power range:** -70 to +44 dBm (100 pW to 25 W), sensor dependent

**Power sensors:** compatible with all HP 8480 series sensors

**Dynamic range:** 50 dB in 10 dB ranges

**Display units:** W, dBm (absolute); %, dB (relative)

#### Accuracy

**Instrumentation:**  $\pm 0.02$  dB or  $\pm 0.5\%$ .

**Zero set:**  $\pm 0.5\%$  of full scale on most sensitive range. Divide by 10 for each higher range.

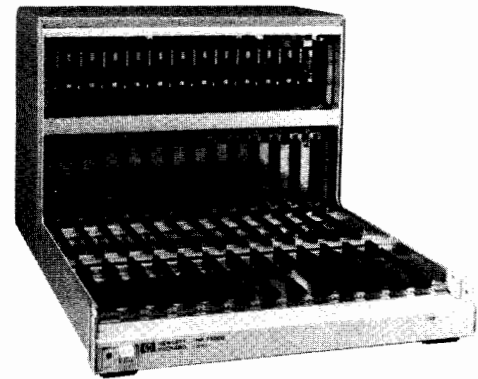

HP E1400T

#### VXI Development Mainframe (HP E1400T)

The HP E1400T development mainframe is a version of the HP E1400B Series C mainframe that can be used as a VXI development or repair station. The mainframe allows easy access to modules that are being developed or repaired. The HP E1400T mainframe meets all specifications of the HP E1400B mainframe, including power and cooling.

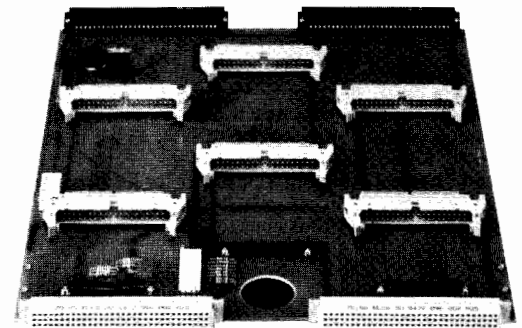

HP E1323A

#### VXI Preprocessor for HP Logic Analyzers (HP E1323A)

The HP E1323A VXI interface provides a complete mechanical and electrical connection between a VXI frame and an HP 16500- or 1650- series logic analyzer. With this equipment you can monitor VXI cycle types and capture bus error conditions using the logic analyzer's state analysis with inverse assembly, or observe timing waveforms and bus handshakes with timing analysis.

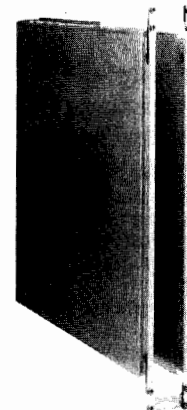

HP E1403A

#### A/B-size Module Carrier (HP E1403A)

The HP E1403A A/B-size Active Module Carrier extends the VXIbus backplane (P1 only) so VXIbus A and B-size modules can plug into the backplane of the HP 75000 Series C Mainframe and still mount with their front panels flush with the front panel of other C-size modules.

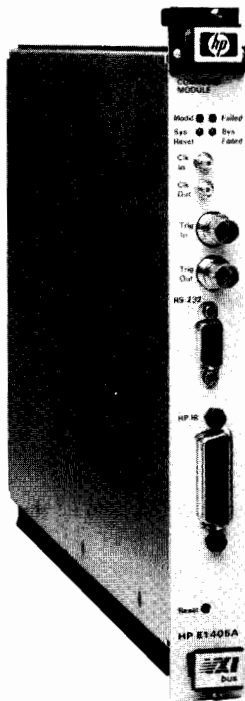

HP E1405A

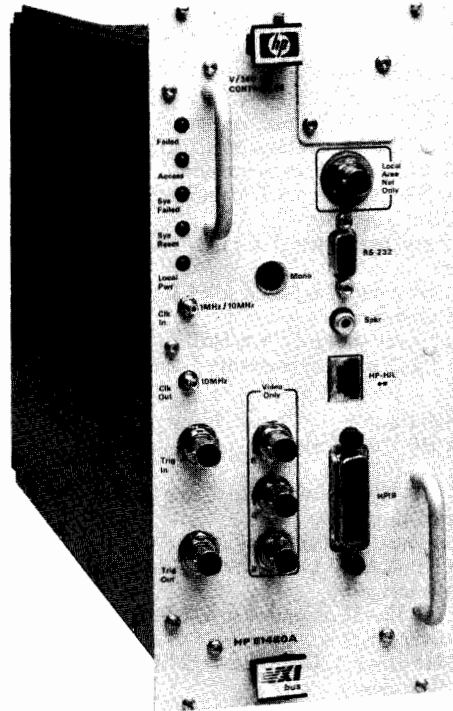

HP E1480A

**Command Module (HP E1405A)**

The HP E1405A command module is a C-size VXI module that has all Slot 0 and resource manager capabilities required by VXI. This module is an HP-IB to VXI interface, and it makes both register-based and message-based modules appear as HP-IB instruments to an external computer. Built-in SCPI (equivalent to TMSL) makes it easy to program HP register-based cards, including all HP B-size modules. Built-in SCPI also allows ITG to access register-based cards.

SCPI provides consistent instrument commands across different types of instruments. The command module provides a compatible growth path from the low-cost HP 75000 Series B to the high-performance HP 75000 Series C. Users can issue high-level, IEEE-488.2-compatible SCPI commands to program modules instead of sending binary data to and from registers.

**Features**

- HP-IB to C-size VXI interface
- Slot 0 plus resource manager
- Use in the HP 75000 Series C mainframe to provide SCPI capability for all register-based modules

**HP IBASIC Controller (HP E1300A Option 020, 021, 022; HP E1301A Option 020,021, 022; HP E1405A Option 020)**

Add computing power to your system with more than 150 HP IBASIC commands, which are a subset of the popular HP BASIC language.

- For Series B mainframe or Series C command modules
- Run programs stand-alone
- Auto-start from flexible or hard disk
- Standard with 512 Kbyte non-volatile RAM
- Optional 1 Mbyte or 2 Mbyte non-volatile RAM for Series B
- Use a RS-232 terminal for development and display
- Control other equipment with RS-232 or HP-IB
- Remotely control Series B mainframe or Series C command module with RS-232/422

**V/360 Controller (HP E1480A)**

The HP E1480A V/360 controller occupies four C-size VXI slots and has all Slot 0 and resource manager capabilities required by VXI. It has built-in HP-IB, RS-232, LAN, keyboard and display ports. This module can access message-based modules on the backplane, or register-based modules by sending SCPI commands through the HP-IB port on the command module (HP E1405A).

This controller is a Motorola 68030-based computer that can run either the HP BASIC/WS or HP-UX operating systems. With HP BASIC/WS, instrument control for a single-user, single-tasking system is simplified through high-level commands optimized for I/O operations. With HP-UX, industry standard networking, windowing systems, and databases can be used with automated test. (Additional Model 360-specific information can be found on page 608.)

**Features**

- Fast Motorola 68030-based computer
- Runs either HP BASIC/WS or HP-UX (including HP BASIC/UX)
- Built-in HP-IB, RS-232, LAN, keyboard and display ports
- HP-ITG compatible
- Disk interface
- 4 slots

**COMPUTER AIDED TEST****HP 75000 Family of VXI Products****Ordering Information****Ordering Information****Series C mainframes**

**HP E1492A** HP 75000 Series C starter system

Includes HP E1400B mainframe with option 908 plus HP E1405A command module.

\$8,750

**HP E1400B** HP 75000 Series C mainframe

\$6,275

**Opt 907** front handle kit

+\$170

**Opt 908** Rackmount flanges & rails (includes hardware)

+\$180

**Opt 909** Rackmount flanges, handles & rails<sup>2</sup> (Includes hardware)

+\$350

**E1400-80003** Rack slide kit (includes heavy duty slides, cable tray, hardware, non-tilting, see Note 3)

1

**Series B mainframes**

**HP E1300A** HP 75000 Series B mainframe without front panel

\$2,300

**HP E1301A** HP 75000 Series B mainframe w/front-panel keyboard/display

\$2,800

**System options installed (pick one):**

**Opt 020** HP IBASIC Controller w/512 kbyte nonvolatile memory

+\$1,000

**Opt 021** HP IBASIC Controller w/1 Mbyte nonvolatile memory

+\$1,600

**Opt 022** HP IBASIC Controller w/2 Mbyte nonvolatile memory

+\$2,400

**Opt 010** 512 kbyte nonvolatile memory

+\$600

**Opt 011** 1 Mbyte nonvolatile memory

+\$1,000

**Opt 012** 2 Mbyte nonvolatile memory

+\$1,800

**Disk storage options installed (pick one)- requires HP IBASIC:**

**Opt 005** 3 1/2 inch flexible disk drive only

+\$850

**Opt 006** 20 Mbyte ruggedized hard disk only

+\$1,900

**Opt 007** 20 Mbyte ruggedized hard disk plus flexible disk

+\$2,100

**Opt 008** External dc power operation installed

+\$700

**Opt 009** HP E1326B 5 1/2-digit multimeter

+\$1,340

installed internally

**Opt 907** Front handle kit

+\$80

**Opt 908** Rackmount flanges & rails (includes hardware)

+\$130

**Opt 909** Rackmount flanges, handles & rails<sup>2</sup> (includes hardware)

+\$210

**1494-0059** Rack slide kit (includes hardware non-tilting)

\$100

**Interfaces**

**HP E1324A** RS-232C/422 data comm

\$650

**Field installation kits**

**HP E1300-80001** HP IBASIC (requires at least 512 kbyte memory)

\$700

**HP E1300-80002** 512 kbyte nonvolatile memory for Series B mainframe (2 Mbyte maximum per mainframe)

\$600

**HP E1300-80003** 1 Mbyte nonvolatile memory for Series B mainframe (2 Mbyte maximum per mainframe)

\$1,000

**HP E1300-80005** 3 1/2 inch flexible disk drive (requires HP IBASIC and disk controller)

\$200

**Price**

**HP E1300-80006** 20 Mbyte hard disk (requires HP IBASIC and disk controller)

\$1,250

**HP E1300-80011** Disk controller for Series B mainframe (only one required per mainframe)

\$650

**HP E1300-80008** External dc power operation for Series B mainframe

\$700

**HP E1326-80002** Internal installation kit for Series B mainframe for HP E1326B 5 1/2 digit multimeter

\$142

**Series C Command Module**

**HP E1405A** Command module

\$2,800

**Opt 020** HP IBASIC controller

1

**Power meters**

**HP E1416A** Power meter

\$2,500

**Opt 915** Service manual

+\$50

**Opt 916** Additional users' manual

+\$50

**HP 11730A** Accessories supplied: One 1.5 meter 5 ft sensor cable

\$0

**Multimeters**

**HP E1410A** 6 1/2-digit multimeter (includes bus cable)

\$3,500

**Opt 1BN** MIL-STD-45662A calibration certification

+\$200

**HP E1411B** 5 1/2-digit multimeter, Series C (includes bus cable)

\$1,600

**Opt 1BN** MIL-STD-45662A calibration certification

+\$160

**HP E1326B** 5 1/2-digit multimeter, Series B (includes bus cable)

\$1,200

**Opt 1BN** MIL-STD-45662A calibration certification

+\$120

**E1326-80002** Internal installation kit for HP E1326B 5 1/2-digit multimeter

\$142

**Oscilloscopes**

**HP E1426A** Digitizing oscilloscope

\$6,950

**Counters**

**HP E1420A** Universal counter

\$3,450

**Opt 010** TCXO time base

\$500

**HP E1332A** 4-channel counter/totalizer

\$900

**Opt 1BN** MIL-STD-45662A calibration certification

+\$90

**HP E1333A** 3-channel universal counter

\$900

**Opt 1BN** MIL-STD-45662A calibration certification

+\$90

**Sources**

**HP E1440A** 21 MHz synthesized function/sweep generator

\$5,700

**Opt 001** high-voltage output

\$310

**HP E1328A** 4-channel D/A converter

\$1,100

**Digital**

**HP E1330A** Quad 8-bit digital input/output (includes interface cable)

\$600

## Ordering Information

### Relay multiplexers

HP E1345A 16-channel relay multiplexer (includes bus cable)	\$650
HP E1346A 48-channel single-ended relay multiplexer (includes bus cable)	\$800
HP E1347A 16-channel thermocouple relay multiplexer (includes bus cable)	\$750
HP E1460A 64-channel relay multiplexer (includes bus cable)	\$2,400
HP E1355A 8-channel 120-Ohm strain relay multiplexer	\$925
HP E1356A 8-channel 350-Ohm strain relay multiplexer	\$925

### FET multiplexers

E1351A 16-channel FET multiplexer	\$875
E1352A 32-channel single-ended FET multiplexer	\$1,000
HP E1460A 16-channel thermocouple FET multiplexer	\$975
HP E1357A 8-channel 120-Ohm strain FET multiplexer	\$1,125
HP E1358A 8-channel 350-Ohm strain FET multiplexer	\$1,125

### RF multiplexers

HP E1366A 50-ohm RF multiplexer (2 X 4: 1)	\$850
HP E1367A 75-ohm RF multiplexer (2 X 4: 1)	\$850
HP E1472A 50-ohm RF multiplexer (6 X 4: 1)	\$2,500
HP E1473A 50-ohm RF multiplexer expander (6 X 4: 1) (includes cable)	\$1,500
HP E1473-80002 Cable extension kit for RF multiplexer expander (2 cables)	\$66

### Microwave

HP E1368A 18 GHz microwave switch	\$2,100
HP E1369A Microwave switch driver (includes cable)	\$500
HP E1370A Microwave switch/attenuator driver	\$500

### Switches

HP E1468A 8 x 8 relay matrix	1
HP E1469A 4 x 16 relay matrix	1
HP E1361A 4 x 4 relay matrix	\$650
HP E1364A 16-channel Form C switch	\$650

### Development tools

HP E1400T VXI development mainframe	\$6,275
HP E1323A VXI preprocessor for HP logic analyzers	\$1,200
HP E1402A VME module adapter	\$550
HP E1399A Register-based breadboard, Series B	\$400
HP E1490B Register-based breadboard, Series C	1
HP E1403A A/B-size active module carrier	\$298
HP E1408A A/B-size module carrier	\$298
HP E1409A Series C chassis shield	\$150

## Price

## System computers

HP E1480A HP V/360 Controller	\$9,950
Includes 4 Mbytes RAM, HP-IB, RS-232, HP-HIL, audio, two-channel DMA, LAN, Slot 0 functionality as well as HP-UX and HP BASIC/UX License-to-use. Monitor, keyboard and software must be ordered separately. You must also order one of Option 500 through Option 550 below.	
Options 010 & 011 cannot be ordered concurrently:	
Opt 010 98262A high-speed HP-IB disk interface	+\$990
Opt 011 98265A SCSI disk interface	+\$400
Opt 108 Add 4 Mbytes RAM for a total of 8 Mbytes RAM	+\$5,040
Opt 112 Add 8 Mbytes RAM for a total of 12 Mbytes RAM	+\$9,780
Opt 116 Add 12 Mbytes RAM for a total of 16 Mbytes RAM	+\$14,200
Opt 500 No graphics subsystem	\$0
Opt 542 98542A medium-resolution monochrome graphics board, 512x480	+\$845
Opt 543 98543A medium-resolution 4-plane color graphics board	+\$1,340
Opt 544 98544A high-resolution monochrome graphics board, 1024x768	+\$1,610
Opt 549 98549A high-resolution 6-plane color graphics board	+\$2,140
Opt 550 98550A high-resolution, high-performance color graphics	+\$4,140
If you plan to communicate directly across the VXI backplane from the V/360, order the following:	
HP E1481A V/360 VXIbus drivers, media & documentation	\$200
HP E1481L V/360 VXIbus drivers, license to use	\$350
HP E1404A Slot 0/Translator	\$850

## Quick interconnect system

HP 34591A quick interconnect fixture	\$125
03235-04111 quick interconnect fixture cover (sheet metal)	\$100
HP 34592A quick interconnect frame (includes rack mount flanges)	\$1,260
HP 34593C internal bulkhead BNC module (mates with 34593A/BT modules only)	\$150
HP 34593AT external solder-to BNC module	\$245
HP 34593BT external bulkhead BNC module	\$425
HP 34594A low frequency feed-through (solder eye)	\$360
HP 34594B low frequency feed-through (screw terminal)	\$540
HP 34501AT terminal module (mates with HP 34594A)	\$150
HP 34501BT terminal module (mates with HP 34594B)	\$325
HP 34597A SimPlate board test fixture	\$700
HP 44210A SimPlate fixture assembly tool kit	\$160
HP 44203K SimPlate spare parts kit	\$225
HP 44561L/H Single point probes (60 deg, bag of 100, L=4 oz force, H=8 oz force)	\$105
HP 44562L/H Serrated point probe (bag of 100, L=4 oz force, H=8 oz force)	\$105
HP 44563L/H Star point probe (bag of 100, L=4 oz force, H=8 oz force)	\$105
HP 44564L/H Spear point probe (30 deg, bag of 100, L=4 oz force, H=8 oz force)	\$166
HP 44274S Standard probe receptacle (bag of 100, one required per probe)	\$38

<sup>1</sup>The price of this product was not available at time of printing.

<sup>2</sup>The front door of the HP 34595A/B cabinets will not close over rackmount handles.

<sup>3</sup>Not compatible with mainframes shipped before April 1, 1990.

This document contains proprietary information of Hewlett-Packard Company. It is intended for internal use only. It is not to be distributed outside the organization.

# COMPUTER AIDED TEST

## Multiprogrammer: User-Adaptable Instrumentation

HP 6942A, 6944A, 6954A, and 14753A Computer Aided Test Software

- Build a test system tailored to your specific application
- Broad range of function-oriented I/O cards with a unified design
- Simultaneous and independent functions
- Isolated power supplies for analog functions
- Mainframe extenders for increased I/O capacity
- High-speed data capture and throughput

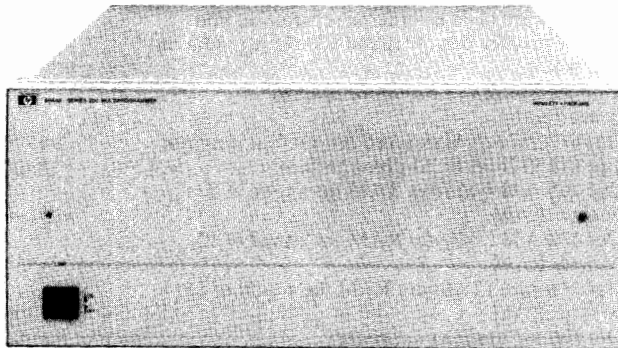

HP 6954A and HP 6944A

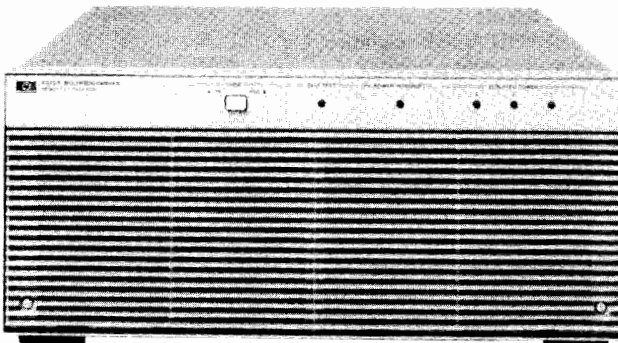

HP 6942A



User selected name matches test function

Stimulus, acquisition or control function selected from supported instrumentation.

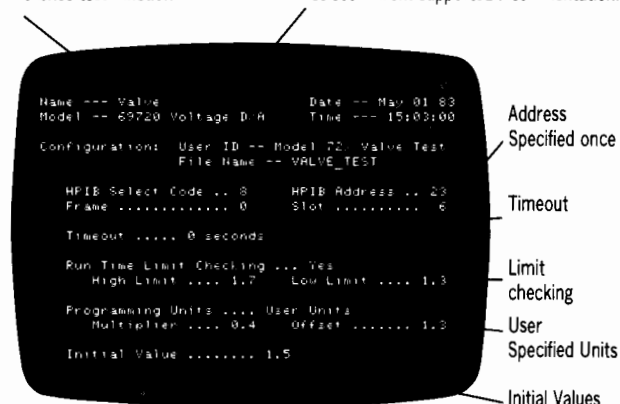

HP 14753A Programming Package

### Introduction

Hewlett-Packard Multiprogrammer products provide solutions for a variety of data acquisition, control and test applications. The application flexibility is due to the architectural features of these products. The plug-in Multiprogrammer I/O cards allow card-to-card communication, isolated inputs and external triggering and provide a wide range of functions. The HP 6942A Multiprogrammer and the Series II I/O cards are a medium-performance, medium-speed, HP-IB solution. For applications requiring a higher level of performance and more speed, the HP 6944A or HP 6954A Multiprogrammer should be considered for use with the Series II I/O cards.

The I/O cards have many benefits. Multiple-card configurations can be established that provide instrument-like functions. For example: high-speed scanning and multiple simultaneous-buffered analog-to-digital converters. Other features provide precise crystal-controlled timing or pacing of I/O operations. This allows the modular construction of instrumentation functions such as frequency measurement, time interval measurement and programmable pulse generation. The card-to-card communication feature allows the I/O operation of the Multiprogrammer to operate independently of the computer. The computer is then free to perform other tasks until it receives an interrupt from the Multiprogrammer. If the application requires the process to control data collection, it can be accomplished via the external trigger feature. This feature allows the process to time or pace operations independently of the computer. In addition, I/O data can be stored in the Multiprogrammer's plug-in memory system, allowing high-speed operation of other tasks the computer must perform.

### HP 6954A Features

- A Rugged Rack-mountable Test System in a Single Unit
- Built-in HP 9000 Series 310 or Series 332 Computer, and 20 Megabyte Hard Disc
- Includes BASIC and HP 14753A CAT Programming Package
- HP-IB, HP-HIL, RS-232, Audio and Video Interfaces
- Local or Remote Control via HP-HIL or RS-232
- Standard HP Multiprogrammer Series II I/O Cards
- HP 9000 Series 200/300 Memory, Accessory, and I/O Cards

### HP 6944A Features

- Data transfer rate of 220,000 readings/second
- HP 98633A interface to HP Series 200/300 computers
- Direct to disc at 200,000 words/second
- Requires HP 14753A CAT programming package
- HP Multiprogrammer Series II I/O cards

### HP 6942A Features

- Data transfer rate 18,000 readings/second
- HP-IB interface
- HP 14753A CAT programming package
- HP Multiprogrammer Series II I/O cards

### HP 14753A Features

- Easy to use menu entry
- Faster software development
- Improved HP 6942A performance

### Ordering Information

**HP 14753A** Computer Aided Test Programming Package

**Price**

Opt 044 3 1/2" Flexible Discs

\$0

Opt 042 5 1/4" Flexible Discs for 9826/9836

\$0

**HP 14753R** Right to Reproduce HP 14753A CAT Programming Package (Interface and Documentation provided)

\$1100



# COMPUTER AIDED TEST

## Multiprogrammer: User-Adaptable Instrumentation

HP 6954A

633

- Built-in HP 9000 Series 300 Computer and 20 megabyte hard disk
- Includes BASIC and HP 14753A CAT programming package
- Controls up to 14 HP-IB instruments or peripherals

- Local or remote control via HP-HIL or RS-232
- Accepts standard HP multiprogrammer series II I/O cards
- Accepts standard HP 9000 Series 200/300 memory, accessory, and I/O cards

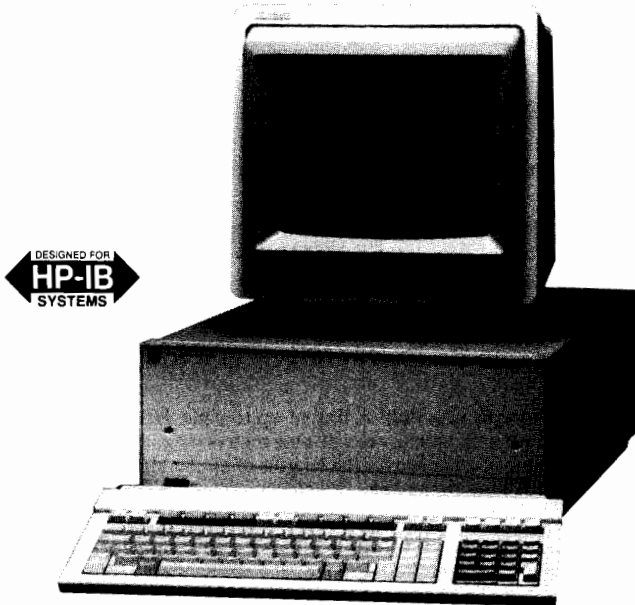

HP 6954A Option 001

### Description HP 6954A Multiprogrammer

The HP 6954A Multiprogrammer is the most powerful addition to HP's family of Computer Aided Test products. The HP 6954A is a complete high speed data acquisition and control system in a single, compact, rack-mountable unit. The HP 6954A Multiprogrammer is suitable for applications in fields such as: electronic production test, automated electronic test, data acquisition, process control, and process/product characterization.

The HP 6954A Multiprogrammer features a built-in HP 9000 Series 300 System Processing Unit, One Megabyte of RAM, a 20 Megabyte Winchester disc drive, HP 98620B DMA card, RS-232, and HP-IB interfaces. The built-in HP-IB interface allows the HP 6954A to control up to 14 HP-IB instruments or peripherals. Connecting a keyboard and monitor to the HP 6954A allows it to be controlled locally. Or, you can control the system remotely via an RS-232 link to a terminal such as the HP 2623A or HP 3082A, a computer running a terminal software package such as The PORTABLE computer, or a host computer such as the HP 1000.

The HP 6954A has two card cages, one that accepts up to eight Multiprogrammer Series II I/O cards, and another that accepts up to three additional Series 200/300 memory, accessory, or I/O cards. You can expand the HP 6954A Multiprogrammer system's I/O capability by adding up to seven HP 6944A Multiprogrammers as extenders to give you 120 slots for standard Multiprogrammer Series II I/O cards. And when HP 6944A Multiprogrammers are used as extenders for the HP 6954A, no extra interface is required because a Multiprogrammer Interface is built into the HP 6954A.

The wide spectrum of capabilities offered by the Multiprogrammer Series II I/O cards gives the Multiprogrammer the capability to digitize analog data at up to 500 KHz, acquire up to 1 Megabyte of 16 bit data at rates up to 760 kHz, or continuously log data directly to internal disc at rates up to 54 kHz. Other I/O card stimulus and response functions include current output, voltage output, pulse output, switching, analog multiplexing, event counting, event sensing, and additional measurement and control functions offered on pages 636 and 637.

The HP 6954A can be used as a development station by simply adding the optional local control kit consisting of an HP keyboard and monitor. HP 9000 Series 200/300 BASIC and the HP 14753A Computer Aided Test Programming package are included with the HP 6954A to give you one of the easiest to use instrument-oriented program development environments available. The HP 6954A is compatible with HP 9000 Series 200/300 software packages such as the DACQ/300 Data Acquisition Manager (HP 44458A/B) that features data management, data analysis, and data presentation.

HP has integrated and assembled the complete system into one rack-mountable unit: a powerful SPU and HP-IB interface for instrument control, a 20 Mbyte disc drive for program and data storage, 1 Mbyte of RAM, BASIC and the CAT Programming package for easy program development, and two types of card cages for versatility and a large selection of I/O functions. The HP 6954A is one of the easiest, most cost effective ways to build an automated test system that is tailored to your specific application.

### Specifications

**Plug in I/O card positions:** A maximum of 8 Multiprogrammer Series II I/O card slots and 3 available HP 9000 Series 200/300 interface and accessory card slots (a fourth slot is occupied by the DMA card).

**Controller interface:** Not applicable. Controller is built in.

**I/O interfaces:** HP-IB, RS-232, HP-HIL, audio and composite video.

**Extender units:** Up to seven HP 6944A's can be linked to the HP 6954A using HP 14704A, B, or C interface cables.

**Maximum length of a link:** A link of up to seven HP 6944A's can extend nine meters long, maximum. This maximum length is the sum of all the HP 14704A, B, or C Interface cables.

**System data acquisition rate:** High data acquisition rates can be attained using Multiprogrammer I/O cards. For example, digital acquisition rates up to 1 MHz are possible using the HP 69791A Memory card and analog acquisition rates up to 500 kHz can be attained using the HP 69759A 500 kHz A/D.

**Data transfer rate:** Using the HP 98620B DMA card (takes up one slot of the four HP 9000 Series 200/300 interface and accessory card slots), data transfer rate between the Multiprogrammer I/O cards and the computer is up to 220,000 readings per second and direct to disc transfer of 200,000 words per second over HP-IB.

**Power supplies:** All necessary power supplies for up to eight Multiprogrammer Series II cards, the controller, and up to four HP 9000 Series 200/300 interface and accessory cards are built into the HP 6954A. Three  $\pm 18$  V supplies (isolated from each other and from ground) are available for powering isolated I/O cards.

**Input power:** 100/120/220/240 Vac (switch selectable), +5% to -10%, 47 to 63 Hz, 630 VA.

**Operating temperature range:** 0 degrees C to +55 degrees C.

**Dimensions:** 177.0 H x 425.5 W x 597.0 mm D (7"x16.25"x23.5")

**Weight (without I/O cards):** Net, 26.4 kg (58 lb.) Shipping, 33.6 kg (74 lb.)

### Ordering Information

HP 6954A Multiprogrammer	Price
HP 6954A Multiprogrammer	\$12715
Opt 332 Replaces the 310 SPU and DMA card of a standard 6954A with a 332 SPU (with 2 Mbyte RAM and on-board DMA)	+\$4000
Opt 001 Local Control Kit	+\$615
Opt 002 Delete BASIC and HP 14753A	-\$1000
Opt W30 Two Year additional warranty (cannot be ordered with Option W03)	+\$200
Opt W03 Warranty conversion to 90-day on-site	\$0
Opt 908 Rackmount kit	+\$46
Opt 910 Extra Installation and Service Manual	+\$36

# COMPUTER AIDED TEST

## Multiprogrammer: User-Adaptable Instrumentation

HP 6944A

- Data transfer rate 220,000 readings/second
- Dedicated interface (HP 98633A) to HP Series 200/300 Computers

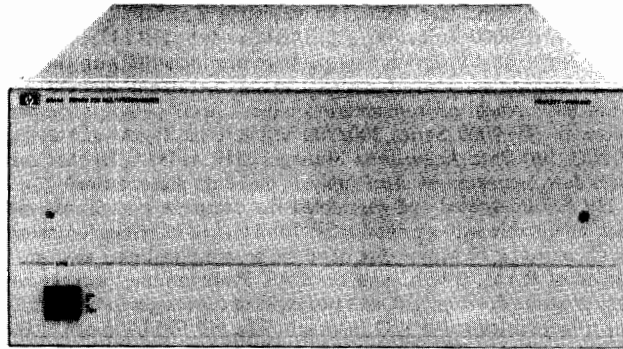

HP 6944A

### Description

The HP 6944A Multiprogrammer is a high-speed data acquisition and control system designed exclusively for use with HP Series 200/300 computers. The HP 6944A capitalizes on the HP Series 200/300 computer architecture by using the dedicated HP 98633A Multiprogrammer Interface and the HP 98620B DMA Controller to achieve high-speed data transfers.

The powerful HP Multiprogrammer Series II I/O cards provide a broad variety of I/O functions for the HP 6944A. These cards allow the user to configure the HP 6944A to implement many instrumentation functions such as high-speed scanning, analog waveform synthesis, limit checking and transient analysis.

The HP 6944A is programmed exclusively with the HP 14753A Computer Aided Test Programming Package. This software package effectively couples the flexible hardware architecture of the HP 6944A with the BASIC language system of the HP Series 200/300 Computers. The friendliness of this system is such that the system programmer only needs to be able to program in BASIC. The control statements are test oriented and closely linked to the application by a list of "Names" supplied by the user. An easy-to-use, menu-driven configuration process correlates the user-assigned "Names" to the system's I/O functions automatically from the BASIC program. The software, through the same menu-driven process, then leads the system programmer through the hardware configuration. The net result is fast program development, self-documented programs and the ability to maintain different configuration files on one disc.

### Features

The primary features of the HP 6944A evolve around the architecture of the HP 6944A, HP Series 200/300 Computers, and the Multiprogrammer Series II I/O cards.

The key feature of the HP 6944A is high-speed data transfer. With the HP 6944A, HP 69759A 500 kHz A/D, HP 69791A/92A High-Speed Memory I/O System, and the HP 98620B DMA Controller Card, data may be transferred to an HP Series 200/300 Computer at rates of 200,000 readings/second. Without the HP 98620B DMA Controller Card, transfer rates of nine kilowords/second are achieved.

A second key feature of the HP 6944A is its ability to unburden the HP Series 200/300 Computer from controlling each I/O task of the HP 6944A. This allows the HP Series 200/300 Computer time to perform numerical analysis or manage other instruments during these time periods.

- Direct-to-disc transfer rate of 200,000 words/second
- HP 14753A CAT programming package
- HP Multiprogrammer Series II I/O cards

### HP 6944A Specifications

**Plug in I/O card positions:** Maximum of 16 plug-in output or input cards per mainframe. Removable rear cover provides access to card slots.

**Computer interface:** The HP 6944A is connected to an HP Series 200/300 Computer via the HP 98633A Multiprogrammer Interface Card and HP 14704A, B or C cable.

**Extender units:** Up to eight HP 6944A Multiprogrammers can be connected to the Series 200/300 computer's HP 98633A Multiprogrammer Interface Card by using HP 14704A, B or C Interface Cables.

**Maximum length of a link:** A link of up to eight HP 6944A Series 200/300 Multiprogrammers can be nine metres long, maximum. This maximum length is the sum of the lengths of all the HP 14704A, B or C Interface Cables in the link.

**Power supplies:** All necessary power supplies for up to 16 I/O cards are built into each HP 6944A frame. Three  $\pm 18$  V supplies are isolated from each other and from ground, and are available for powering isolated I/O card circuits.

**Cooling:** Built-in forced air cooling draws air in through the side vents and exhausts air through the rear cover.

**Operating temperature range:** 0 degrees C to +55 degrees C.

**Power:** 100/120/220/240 Vac (switch, selectable), +5% to -10%, 47 to 63 Hz, 650 VA.

**Dimensions:** 177.0 mm high x 425.5 mm wide x 597.0 mm deep (7.0 in high x 16.25 in wide x 23.5 in deep).

**Weight** (without I/O cards): Net, 21 kg (46 lb); shipping, 28.6 kg (63 lb).

### Ordering Information

#### Step 1: Select the necessary quantity of HP 6944As.

HP 6944A Series 200/300 Multiprogrammer	\$4750
Option 908: rack mount kit	\$37
Option 910: extra operating and service manual	\$42
Option W03: converts 1 yr return-to-HP warranty to a 90-day on-site warranty	\$0

#### Step 2: Select the HP Series 200 Multiprogrammer Interface Card for HP 6944A.

HP 98633A Multiprogrammer Interface Card	\$560
--	-------

#### Step 3: Select number and lengths of cables required for connecting HP 98633A Interface to first frame.

An additional cable is needed for each HP 6944A frame used as an extender.

HP 14704A Multiprogrammer Interface Cable, 1 m (3.3 ft)	\$265
HP 14704B Multiprogrammer Interface Cable, 2 m (6.6 ft)	\$280
HP 14704C Multiprogrammer Interface Cable, 4 m (13.2 ft)	\$320

#### Step 4: Select HP 14753A to receive necessary CAT software and documentation (mandatory).

Select the option appropriate for the system controller.

HP 14753A Computer Aided Test Programming Package	\$2200
Option 044: software provided on 3 1/2" flexible discs	\$0
Option 042: software provided on 5 1/4" flexible discs	\$0
HP 14753R: right to reproduce HP 14753A CAT programming package (documentation provided)	\$1100

- Action-oriented instructions
- Isolated analog inputs and outputs
- Built-in self test

- Overlapped input and output
- Internal or external pacing
- Easy to configure

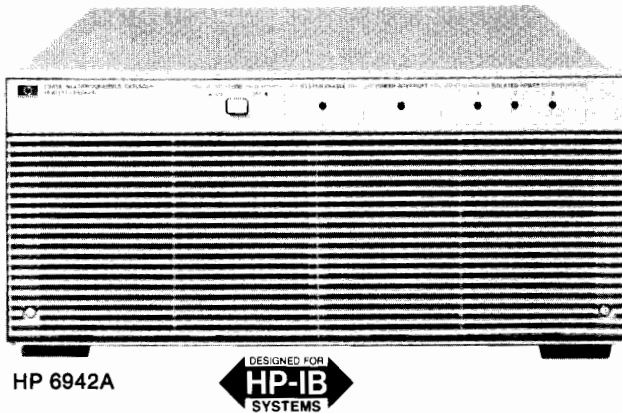

### The Multiprogrammer Performs Operations in Parallel

With this one instrument you can control several processes at once. And, while you are controlling the processes, the Multiprogrammer can also be watching for interrupt conditions. The internal microprocessor manages all the parallel operations and monitors the alarm lines; when the operations have completed or if an alarm condition occurs, the Multiprogrammer interrupts the controller.

### How does the HP 6942A Connect With Your Controller?

The HP 6942A Multiprogrammer interfaces with your controller (desktop or minicomputer) using the HP-IB, Hewlett-Packard's implementation of IEEE Standard 488 and the identical ANSI Standard MC1.1. Data and status readback make use of the extended bus addressing features of the HP-IB.

### Programming Flexibility

Mnemonic, action-oriented instructions make the HP 6942A Multiprogrammer simple to learn and use. For instance, the output instruction "OP" works with all output cards. When you send an instruction, the internal microprocessor checks which type of card you are addressing and automatically converts the data to the proper format for that card. You select the units with which you want to program each card. Whether you want to use volts, millivolts, amps, degrees, feet, or any other units, the Multiprogrammer does the converting for you. The HP 6942A can also be programmed with the HP 14753A CAT Programming Package.

### Mainframe Memory Unburdens The Controller

The mainframe memory of the HP 6942A will accept up to 76 instructions from the controller at one time. This leaves your controller free for other processing activities while the Multiprogrammer works on the I/O operations. This mainframe memory may also be used to collect up to 1440 data readings and hold them until the controller is free to take them. (For even more data storage, up to 1 Meg words of data may be stored using the HP 69791A and HP 69792A Memory System Cards.)

### Real Time Clock

Built-in real-time clock gives you time-of-day readings and pacing of measurements. The clock detects which power line frequency you are using, 50 Hz, or 60 Hz, and automatically synchronizes itself to this frequency. The range of the clock is 65,534 days, with resolution to a tenth of a second.

### Computers and Documentation

The HP 6942A can be operated with a wide variety of computers, including the HP Series 80, Series 200, Series 300, Series 1000, 9825, and 9845 computers. Documentation packages are available for these computers. Each one contains a User's Guide with programming examples, a utility program tape or flexible disc, operating and service manuals, and a binder to hold this material. One no-charge documentation option must be specified to select the documentation appropriate for your computer.

### Accessories

**HP 14700A extender kit:** this kit contains the transmission boards which go into the master mainframe (HP 6942A) and the last extender mainframe (HP 6943A) in the chain.

**HP 14701A intermediate extender kit:** when more than two mainframes are in a chain, the card in this kit must be used in each intermediate extender mainframe.

**HP 14702A chaining cable:** this is the cable which chains together the master and extender mainframes. One cable is required for each extender mainframe. Length: 1.5 m (5 ft).

**HP 14703A card edge connector:** extra connectors for the I/O cards may be ordered in addition to the one supplied with each I/O card.

### HP 6942A/6943A Specifications

**Plug-in I/O card positions:** maximum of 16 plug-in output or input cards per mainframe. Removable rear cover provides access to card slots.

**Computer interface (HP 6942A only):** the Multiprogrammer is connected to a controller via the Hewlett-Packard Interface Bus (HP-IB), Hewlett-Packard's implementation of IEEE Std. 488.

**Real time clock (HP 6942A only):** the built-in real time clock is automatically synchronized with the 50/60 Hz ac power line frequency. The clock is read and set with data in the form of days, hours, minutes and seconds with a resolution of 0.1 second.

**Extender interface kits (HP 6943A only):** each HP 6943A Extender requires one HP 14700A or 14701A Interface Kit and one HP 14702A Chaining Cable for operation with the HP 6942A.

**Maximum number of mainframes per chain:** up to seven HP 6943A Multiprogrammer Extenders may be placed in a chain with one HP 6942A Multiprogrammer.

**Maximum chain length:** a chain of mainframes can be up to 152 meters (500 feet) long. This maximum length is the sum of the lengths of all HP 14702A Chaining Cables used in one chain.

**Power supplies:** all power supplies for up to 16 I/O cards are built-in including three  $\pm 18$  V supplies isolated from each other and from the ground.

**Cooling:** built-in forced air cooling draws air in through the front panel and exhausts air through the ventilated rear cover.

**Front panel indicators:** five light emitting diodes on the front panel indicate power supply and self-test status.

**Operating temperature range:** 0°C to 55°C.

**Power:** 100/120/220/240 Vac (selectable), +5%, -10%, 47 to 63 Hz, 600 VA.

**Dimensions:** 177.0 mm high x 425.5 mm wide x 597.0 mm deep, (6.969 in. high x 16.250 in. wide x 23.500 in. deep).

**Weight (without I/O cards):** net, 20 kg (45 lb); shipping, 27 kg (60 lb).

**Accessories furnished:** PC board Extender Card (HP Part No. 5060-2792).

### Ordering Information

	Price
HP 6942A Multiprogrammer	\$6,500
HP 6943A Multiprogrammer Extender	\$5,200
Opt 010-233 One Set Documentation/Software	\$0
Opt 908 Rack Flange Kit	+\$42
Opt 910 Extra Manual	+\$32
Opt W03 Converts 1 yr return-to-HP warranty to a 90-day on-site warranty	\$0
HP 14700A Extender Interface Kit	\$875
HP 14701A Extender Interface Kit	\$1,060
HP 14702A Chaining Cable	\$425
HP 14703A Spare Card Connector	\$95







# COMPUTER AIDED TEST

## Multiprogrammer Series II I/O Cards: Broad Functionality with a Unified Approach

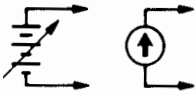
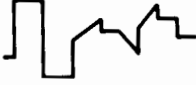
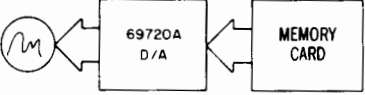
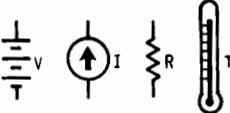
HP 69700A-69793A

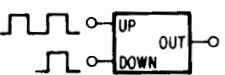
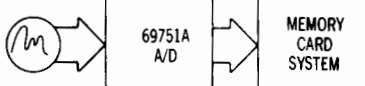
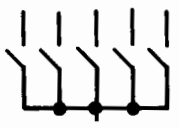
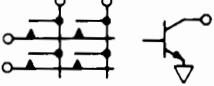
### Multiprogrammer Series II I/O Cards for the HP 6954A, 6944A, and 6942A

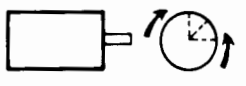
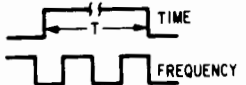
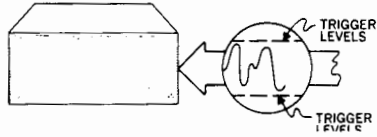
For a complete description of the Multiprogrammer Series II I/O Cards, ask for publication 5952-4175.

	Functions	Applications	Cards Used
STIMULUS	 <p>Programmable DC Voltage and Current</p>	The output voltage (up to 250V) and current (up to 1000A) of forty different HP power supplies can be programmed to provide bias in automatic test systems or control of electromechanical process equipment.	Resistance Output, HP 69700A-69706A; Power Supply Control, HP 69709A.
	 <p>Digital-to-Analog Conversion</p>	Twelve-bit voltage DAC's provide outputs for strip chart, x-y, and analog tape recorders as well as control of analog programmable instruments and stimulus of units under test. Control process equipment with 4-20 mA output.	Voltage DAC, HP 69720A; Current DAC, HP 69721A.
	 <p>Analog Waveform Synthesis</p>	The Memory card can continually supply pre-loaded data to the D/A card at rates of up to 100 kHz. Special waveforms may be loaded into the Memory card from the computer and used as stimuli for test and processes. The analog output is isolated from digital ground.	Memory card, HP 69790B; 69791A, 69792A Voltage DAC, HP 69720A; or Current DAC, HP 69721A.
MEASUREMENT	 <p>Voltage, Current, Resistance, and Temperature Measurements</p>	A/D converters may be used to measure voltages from $\pm 50\mu\text{V}$ to $\pm 100\text{V}$ in the presence of 250 V of common-mode noise. Connecting a resistor across the input permits current measurements for 4-20 mA current loops used in process control. Combine the A/D with the current DAC for resistance measurements.	High Speed ADC, HP 69751A, HP 69759A Integrating DMM HP 69761A
	 <p>Frequency Measurements</p>	The Pulse Counter card accumulates counts over a precise time interval when a Timer card is connected to the enable line of the Counter. The program divides the count by the time interval to measure frequencies from 1 MHz to less than 0.001 Hz.	Counter, HP 69775A; Timer HP 69736A, HP 69774A
	 <p>Pulse Counting Preset Up/Down</p>	The Counter may be preset to any value within the count range of 0 to 65,535 and can cause an interrupt when it rolls over. The Counter may be enabled and disabled by pulses or levels. The computer may read the count without disturbing the counting process.	Counter, HP 69775A, HP 69774A
	 <p>Offline Analog Acquisition</p>	Differential or single-ended signals may be digitized at rates up to 500 kHz by the A/D, and stored in the Memory system. Each Memory system can store up to one megawords. The digitizing process can take place independent of other Multiprogrammer activity.	High Speed ADC, 69751A; Memory cards, 69790B, 69791A/69792B. Integrating DMM HP 69761A.
	 <p>Scanner Systems</p>	Analog measurements from up to 960 channels may be acquired at 25,000 readings per second depending upon the scanner system configuration. Random access to any channel, as well as continuous scanning, are easily accomplished. (See Application Note AN316-3.)	Cards used: Scan Control, HP 69750A; FET Scanners, 69752A or 69755A; Relay Scanner, HP 69754A. Temp-scan HP 69753A; DMM HP 69761A; High Speed ADC HP 69751A; Memory card HP 69790B, or 69791A/92A
CONTROL	 <p>Digital Output and Switching</p>	Sixteen-bits of data in TTL, open collector, or SPST relay-contact form provide digital control of instruments and indicators. AC power, up to 6, can be switched to 12 loads with a HP 69731B, and HP 14570A AC Power Controller.	Digital Output, HP 69731B; Relay Output, HP 69730A; AC Power Controller, HP 14570A.
	 <p>Digital Input</p>	Digital input cards accept 16-bits of data from digital measuring instruments, push-buttons, switches, relays, and other digital devices in the form of logic levels or contact closures. Digital data sources with more than 16-bits of data use several digital input cards.	Digital Input, HP 69771A; Isolated Digital Input, HP 69770A.
	 <p>Stepping Motor Control</p>	The Stepping Motor card can produce from 1 to 32767 pulses at either of two outputs (CW or CCW) to control motor translators. Output pulses are also used for pulse-train update of supervisory control stations. The pulse rate (motor speed) is also programmable.	Pulse Train/Stepping Motor, HP 69735A, HP 69734A
	 <p>Time and Frequency Reference</p>	Crystal controlled timing pulses, programmable from 100 ns to 18 hours, may be used as a time-base reference for control, measurement, and data acquisition. Period, duty cycle, and number of pulses are all programmable.	Timer, HP 69736A or Pulse Train, HP 69735A, HP 69734A
ALARM	 <p>Level Detecting</p>	When signals cross preset levels, the Digital Input card can trigger the interrupt card to interrupt the computer. The alarm trigger levels can be programmed with the D/A or fixed with resistors.	Digital Input HP 69771A; Interrupt card, HP 69776A.
	 <p>Event Sensing</p>	A digital word may be used to trigger quick computer response with the interrupt card. The computer responds to the interrupt with a software routine. The interrupt may also cause immediate local response by triggering a preloaded output card.	Interrupt card, HP 69776A.

**Ordering Information continued****HP 69752A 64 Channel FET Scanner Card**

Scans 64 single-ended channels ( $\pm 10.24$  V input signal range) at up to 25,000 readings per second. Cards cascable to 960 channels in a single mainframe.

**HP 69755A 16 Channel FET Scanner Card**

Same as 69752A, except scans 16 channels.

**HP 69754A 32 Channel Relay Scanner Card**

Scans 32 single-ended (16 double-ended) channels with a  $\pm 100$  V input signal range at speeds up to 1000 readings per second (625 readings double-ended). Switches currents up to 50 mA.

**HP 69750A Scan Control/Pacer Card**

Provides all pacing and control functions for the scanner cards listed above. One required for each group of scanner cards (maximum of 15 cards—see data sheet for further clarification).

**HP 69709A Power Supply Control Card**

Used for full system control of 6024A and 6012A Autoranging Power Supplies.

**HP 14728A Buffered A/D Cable**

Used to connect 69751A and 69790B in a buffered A/D configuration.

**HP 69700A-69706A Resistance output cards:** the output of each of these cards is a programmable resistance value. Twelve mercury wetted relay contacts close across binary weighted precision resistors in a series string. The cards are designed to program the voltage or current output of an HP power supply with option 040.

**HP 69720A D/A voltage converter card:** provides a high speed, bipolar output voltage programmable from  $-10.240$  V to  $+10.235$  V up to 5 mA load current.

**HP 69721A D/A current converter card:** provides a bipolar  $-20.480$  mA to  $+20.475$  mA current output.

**HP 69730A Relay output card:** provides sixteen independent, normally open, mercury wetted relay contacts. Contacts rated at 100 Vdc; or 1 Amp; and 28 VA.

**HP 69731B Digital output card:** provides sixteen TTL or CMOS compatible outputs, or sixteen 100 mA open-collector switches.

**HP 69734A Timebase card:** generates pulses from 100 ns to 18.2 hours, or squarewaves from 5 MHz to 7.6 uHz. It has over twenty modes including one-shot, squarewave, pulse, and a variety of triggered modes. Positive and negative true outputs are available with 50-ohm drive capability. When using the HP 14753A CAT Programming Package with this card, version A.01 or newer is required.

**HP 69735A Pulse train output/stepping motor control card:** generates up to 32767 pulses at a programmable frequency.

**HP 69736A Timer/pacer card:** outputs a programmable pulse from one microsecond to eighteen hours or a programmable square wave.

**HP 69751A A/D converter card:** this card measures bipolar dc voltages in one of four ranges,  $\pm 100$  mV,  $\pm 1$  V,  $\pm 10$  V, or  $\pm 100$  V, with 12 bit resolution at up to 33,000 readings per second.

**HP 69753A Temperature Scanner card:** allows 16-channel temperature measurements and is expandable to 240 channels. Performs Hi/Lo 2-wire switching for thermocouple measurements and 4-wire RTD measurements, and has an on-board isothermal block for a temperature reference. When using the HP 14753A CAT Programming Package with this card, version A.01 or newer is required.

**HP 69761A Integrating DMM card:** fully programmable, general purpose DMM with 13K of on-board memory and 16-bits of resolution. Optimized for controlling up to 15 HP 69753A Temperature Scanner cards with an on-board pacer. When using the HP 14753A CAT Programming Package with this card, version A.02 or newer is required.

**Price**

\$1,475

\$740

\$1,115

\$850

\$1,265

\$375

\$680-795

\$855

\$1,145

\$720

\$530

\$1,500

\$610

\$615

\$1,150

\$1,485

\$2,175

**HP 69770A Isolated digital input card:** breaks the path of potential ground loops with an optically coupled isolator in each of the sixteen digital input lines. \$790

**HP 69771A Digital input/analog comparator card:** monitors up to sixteen contact closures, switches, TTL signals, CMOS signals, or analog signals. The switching threshold can be set to any value between  $\pm 9.5$  volts by a screwdriver-adjustable potentiometer on the card or may be externally programmed. \$720

**HP 69774A Universal Counter card:** fully programmable, five function counter for frequency, period, time interval, event counting, and quadrature detection. The three operating modes are 32-bit (for up to 2032-1 counts), dual independent 16-bit, or continuous with no "dead-time". When using the HP 14753A CAT Programming Package with this card, version A.01 or newer is required. \$1,550

**HP 69775A Counter/totalizer card:** counts contact closures, TTL or CMOS logic level pulses, or analog waveform transitions in the range of 0 to 65,535. \$890

**HP 69776A Interrupt card:** compares up to sixteen logic level or contact closure inputs with a sixteen-bit reference word and interrupts for =,  $\neq$ , <, > conditions. \$680

**HP 69790B Memory card (occupies 2 I/O slots):** provides 4096 16-bit words for use with the DAC cards or the ADC cards or for other input/output tasks that need to run independent of other Multiprogrammer or computer tasks. Several Memory cards may be used to implement truly simultaneous operations. \$1,260

**HP 69793A Breadboard card:** the generalized grid area on this card may be used for mounting custom circuits. \$215

**HP 69759A - 500 kHz A/D**

The HP 69759A 500 - kHz A/D converter measures bipolar voltages in four programmable ranges,  $\pm 100$  V,  $\pm 10$  V,  $\pm 1$  V, and  $\pm 100$  mV. The digitized values may be read directly by the controller or transferred into HP 69791A and HP 69792A memory buffer cards available for the Multiprogrammer system. Use of memory buffers permits simultaneous digitization at rates up to 500 kHz per channel. Scanning subsystems designed specifically to work with the HP 69759A card provide additional measurement flexibility and permit expansion up to 7168 channels. Timebase and triggering functions may be added using other Multiprogrammer cards to form a complete analog measurement system that is precisely tailored to the requirements of the specific application.

Application Note 316-5, Data Capture, describes several ways that the HP 69759A can be used with other Multiprogrammer cards to solve several different applications. These descriptions include cable diagrams and program listings for both the HP 14752A and the HP 6942A native instructions.

**HP 69791A/92 - Memory System**

The HP 69791A and HP 69792A Memory Cards form a buffer used to perform input and output tasks without intervention from the controller. A memory card buffer can be used for inputs or outputs, or both. Data can be acquired at up to 760 kilowords/second or sent at up to 400 kilowords/second.

A memory card buffer has one HP 69791A Memory Card and up to five HP 69792A Memory Expansion Cards for a maximum memory size of 1M (1,048,576 16-bit words). The HP 69791A holds 64k (65,536 16-bit words) and the HP 69792A holds 192k (196,608 16-bit words). The memory card buffer functions as a single memory, regardless of how many HP 69792As are added.

The memory card subsystem can be used with the HP 69751A or HP 69759A A/D cards to input digitized analog measurements. Up to eight HP 69759A A/D Cards can be multiplexed into a single HP 69791A/69792A memory buffer. The A/Ds can be triggered by the same timebase for truly simultaneous readings which are then stored in sequential memory locations. This reduces memory costs and the number of mainframe slots required.

**Ordering Information****HP 69759A A/D Converter****HP 69791A Memory Card****HP 69792A Memory Card****Price**

\$2,800

\$2,080

\$1,325

# AUTOMATIC TEST

## System Integration

HP ATS 2000



- Modular Systems Using Standard Test Instrumentation for Cost Reduction and Configuration Flexibility
- Manufacturing and Maintenance Applications
- Complete Integration, Installation and Support Services
- Single-vendor Solution

### A Modular Approach to Solving Test Problems

With ATS 2000, HP provides a customized solution for complex functional test needs. Based upon the integration of standard HP instruments and controllers, HP ATS 2000 offers test solutions for manufacturing and maintenance of boards and modules in communications systems, PBX, radar, navigational/guidance and other avionics, and pre-flight satellite checkout.

HP's broad range of computation and instrumentation resources is backed up by 20 years of experience in providing fully-integrated systems to meet the requirements of commercial and military testing applications, with the added benefits of a single-vendor solution.

HP works with each customer to configure a system to custom-fit the test application, and then performs all the many hardware and software functions to fully integrate the system. In addition, HP offers user training and long-term support of the customer's system.

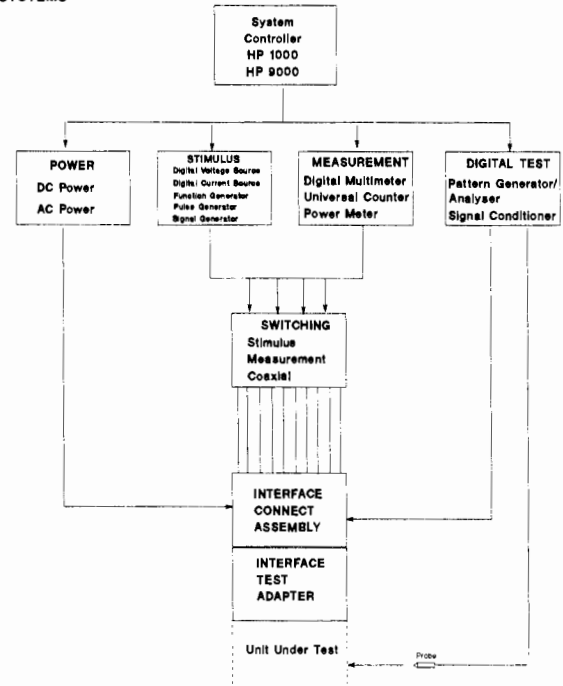

ATS 2000 Block Diagram

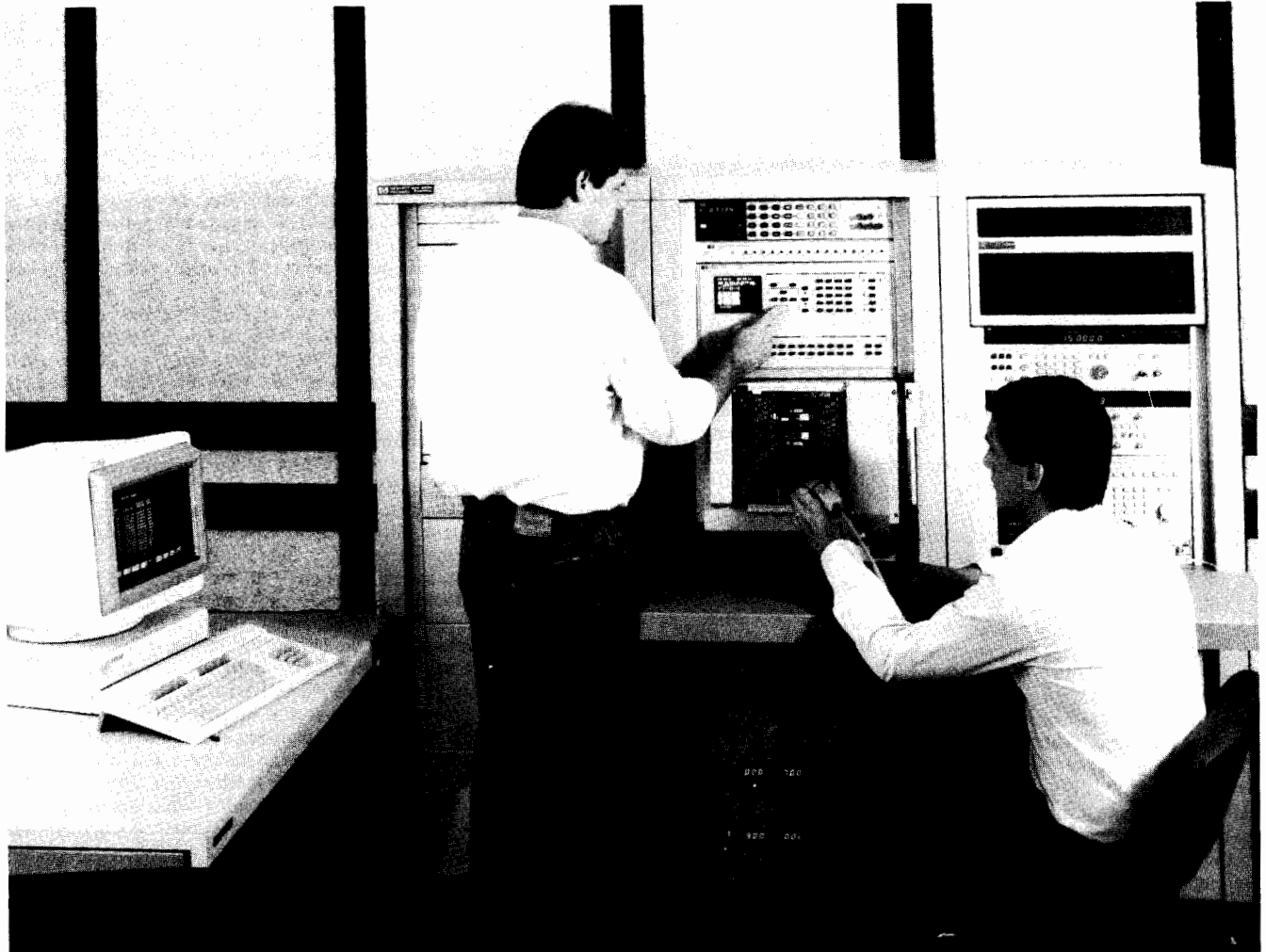

## System Controller

A host controller drives the test system. The choice of a controller is based upon current computing and testing requirements as well as anticipated future expansion of the system. The ATS 2000 offers two standard HP offerings:

The HP 1000 is supported by a powerful real-time operating system (RTE-A), and features fast efficient handling of I/O. The HP 1000 controller has a complete device subroutine library supporting over 200 instruments.

The HP 9000 is supported by HP-UX, Hewlett-Packard's UNIX-based operating system. HP-UX allows up to 84 independent virtual processes to execute simultaneously, but this number can be modified according to the user's particular application requirements.

## Standard HP Stimulus and Response Instrumentation

HP brings to the ATS 2000 a wealth of standard, programmable instruments for UUT stimulus and response measurement, such as digital multimeters, counters, signal sources, and analyzers together with a selection of programmable power supplies. Integration of off-the-shelf instruments substantially reduces system cost and facilitates modifications to the system configuration to accommodate changes in the customer's application that may occur with time.

## Switching

The switching module routes signals between the UUT and analog stimulus/response instruments. The HP 3235A Switch/Test Unit is used for switching in the ATS 2000 systems. This switch comprises a 10-slot intelligent card-cage, with 13 different switch modules available in various matrix and multiplexer topologies to switch signals up to 10 Amps and from DC to 26.5 GHz.

## Digital Test Unit

Required for digital test capability, a digital test unit (DTU) generates input patterns to the UUT and analyzes the output responses at real-time functional speeds. Two major components comprise the ATS 2000 DTU: a pattern generator analyzer and a signal conditioner.

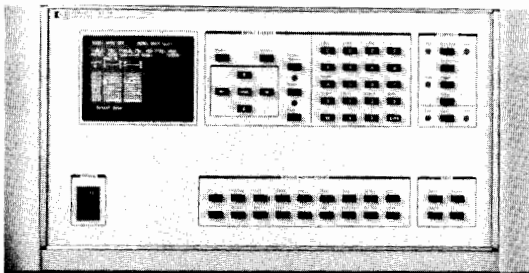

The HP 9417A Pattern Generator/Analyzer controls digital testing, performing stimulus and response analysis functions. From 64 to 128 non-multiplexed, bi-directional channels are provided by the HP 9417A, which may be expanded to 512 channels with the HP 9418A Expansion Chassis. Up to five independent 4K memories (output, expected, tristate, mask, response) are provided per channel for real-time response comparison. Linear or algorithmic stimulus and response allows efficient test programming. Measurement accuracy is enhanced through adjustable skews for compensation of all propagation delays. An HP 94180A Guided Probe is available for backtracing and fault diagnosis.

The HP 9419A Signal Conditioner serves as the interface between the HP 9417A and the test adapter or UUT, providing multiple logic levels with maximum signal integrity. The HP 9419A supports logic families in the range of  $\pm 15V$ , including TTL, ECL, CMOS, and DTL.

## Digital Test Software

The DTU is controlled by the Digital Test Executive (DTE), a modular family of software components which integrates various simulators with the DTU hardware for simulator-based testing. The DTE consists of a run-time analyzer, file configurator, file reporter, and a file generator if simulator-based testing is required.

The HP 9423A Run-Time Analyzer extracts test data, such as stimulus and response vectors, circuit topology, node state, timing information and fault diagnosis data, from the user's circuit simulation software.

The HP 9425A File Reporter allows access to the DTE file at any time during the test process for the test pattern verifications.

A variety of file generators are available to map simulator output into a DTE-compatible format.

User programming of the ATS 2000 DTU is simplified using a set of over 120 subroutines in the HP 9426A Digital Device Subroutine Library.

## System Resource Interface

A unit-under-test interface provides the signal path between a test system and a UUT. The ATS 2000 System Resource Interface (SRI) provides a well-defined, high-integrity interconnect path for digital, analog, and RF stimulus and response signals between the test system and the UUT.

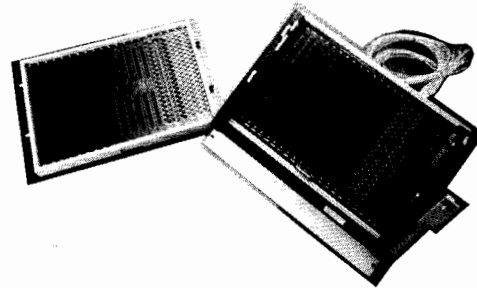

The SRI consists of two subassemblies: the HP 9420A Interface Connect Assembly (ICA), and the HP 9421A Interface Test Adapter (ITA).

The SRI is offered in 4,000-pin (single-tier) and 8,000-pin (dual-tier) configuration. A single customized ICA is used with multiple low-cost ITAs for different UUTs or families of UUTs.

## System Software

System software includes the operating system, a device subroutine library for programming more than 200 HP instruments from Pascal, BASIC or FORTRAN, and a system functional test program.

## System Integration

Integration services for the ATS 2000 are initiated with a study of the customer's test application to arrive at a system configuration. The integration process includes system design hardware and software configuration, system assembly, racking and cabling, design of a system functional test program and hardware adapter, optional pre-shipment customer acceptance, site preparation and installation, on-site testing, comprehensive system-level documentation, and other support services. ATS 2000 Customer Training Courses are also available.

## Ordering Information

Each ATS 2000 system is designed specifically to meet individual customer needs. For more information, consult your local HP Sales Office.

# TECHNICAL COMPUTER SYSTEMS

## HP 9000 Technical Computers

### HP 9000 Workstations

HP 9000 workstations provide high-performance computation and advanced graphic systems for a wide range of engineering and scientific applications ranging from design to simulation, from technical publishing to numerical analysis.

The HP 9000 technical computer family consists of Series 300, Series 800 and the recently announced HP Apollo Series 400 workstations. The 9000 family can provide object-code compatibility across the Series 800 (based on PA-RISC Precision Architecture) and the Series 300/Series 400 (based on Motorola MC680X0 microprocessors). Up to 3200 applications are available for this family of workstations.

All three series run the HP-UX operating system which is a powerful and flexible environment particularly suited for technical computing and advanced graphics applications. The Series 400 can also run Domain/OS, the operating environment that helped build Apollo's reputation for innovative workstation computing. Both operating systems are UNIX-based, complying with the UNIX System V Interface Definition. HP 9000 workstations have available extensive networking connections and capabilities which makes them easy to configure in a LAN environment.

### The HP Apollo 9000 Series 400

The Series 400 workstations are the first products released by HP that combine the innovation of Apollo with the quality and reliability expected from HP. You can choose either the HP-UX or the Domain/OS operating system so you can move up to the Series 400 from older HP or Apollo workstations and utilize existing programs and data files. You can acquire the latest in performance while taking advantage of over 3200 existing applications. A preloaded user interface, HP Visual User Environment (HP VUE), is window-based and mouse-driven to aid productivity.

HP Apollo 9000 VRX Graphics Systems provide powerful, easy to use 2D and 3D graphics for the Series 400 (except the 400dl). Using the highly versatile 10-plane (8 bit + 2 overlay) color systems for 2D applications, HP offers the best X Windows graphics performance in the industry. The PersonalVRX, designed specifically for 3D MCAD/MCAE applications, generates advanced, realistic graphics through a transform engine that off-loads graphics processing from the CPU to boost overall systems performance. TurboVRX graphics systems, which utilize up to 3 Intel i860™ processors, are available for Model 400s and Model 433s to deliver high-performance 3D modeling and rendering.

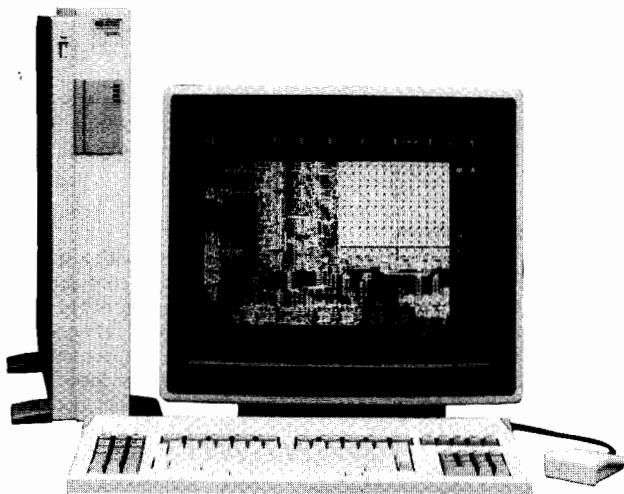

The entry-level HP Apollo 9000 Series 425t workstation with 19" monitor and mouse, delivers 20 MIPS with a 25Mhz MC68040 processor.

### Model 400dl

The Model 400dl is the lowest cost member of the Series 400 family designed for cost-sensitive diskless applications. It's based on the MC68030 processor running at 50 MHz with integer performance of 12 MIPS. Its MC68882 floating point coprocessor performs at 0.5 MFLOPS. Memory of 8 or 16 Mbytes of ECC (error checking and correcting) RAM is available. The Model 400dl comes with a 19" monochrome monitor. It can easily be networked through Ethernet LAN capability. Either desktop or deskside configurations are available. The Model 400dl may be upgraded to a MC68040 for higher performance.

### Model 400t

The Model 400t is an entry-level, MC68030-based workstation incorporating the MC68882 floating point processor and a 200MB hard disk. It is also a desktop or deskside system delivering 12 MIPS integer performance at 50 MHz clock speed. The Model 400t has built-in capability for networking, graphics and expansion through a SCSI interface. Options include VRX Graphics Systems, and advanced 3D graphics through the PersonalVRX. 400t buyers can move up to the 425t through the purchase of an inexpensive MC68040 upgrade kit.

### Model 425t

The Model 425t incorporates the MC68040 processor for integer performance of 20 MIPS, an increase of up to 60% over the performance of the Model 400t. Its floating point speed is seven times that of the 400t. The Model 425t provides the flexibility to configure, and then expand, a system with networking, graphics, mass storage and SCSI interface options. PersonalVRX provides powerful 3D graphics capability and offers superior 2D X Windows performance. Like the 400t, the Model 425t can be configured for desktop or deskside placement.

### Model 400s

The deskside Model 400s is designed for graphics-intensive applications. It is based on the MC68030 microprocessor rated at 50 MHz clock speed and delivering 12 MIPS integer performance. It also incorporates the MC68882 floating point processor performing at 0.5 MFLOPS. The Model 400s provides ISA(PC-AT), SCSI, networking and mass storage options. Advanced graphics capability can be provided through the PersonalVRX or TurboVRX graphics systems. Model 400s performance can be upgraded with an inexpensive MC68040 processor kit.

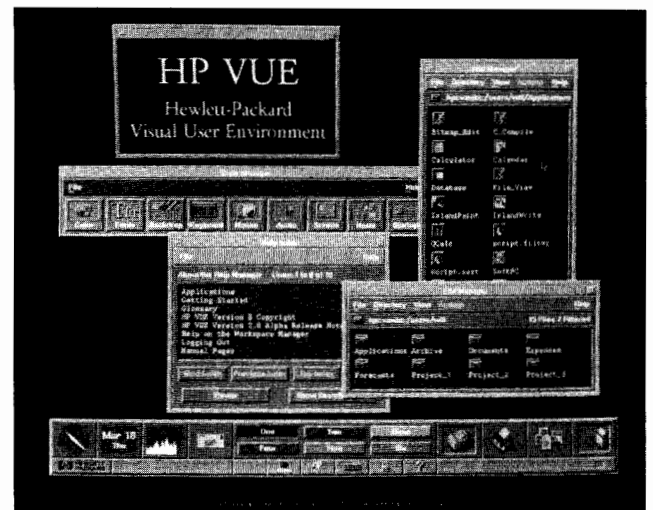

HP Visual User Environment (HP VUE) makes HP 9000 and HP Apollo 9000 workstations easy, even for those not experienced in UNIX systems. HP VUE is now shipped with every HP 9000 and HP Apollo 9000 workstation.



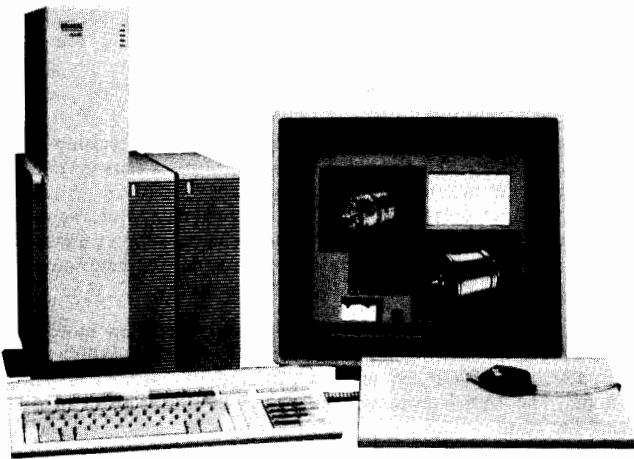

The HP Apollo Model 433s workstation with the PersonalVRX graphics system provides the capability to produce outstanding 3D design and graphic realism.

### Model 433s

The Model 433s is based on the MC68040 processor with on-chip floating point. With a 33MHz processor performing at 26 MIPS and 4.5 MFLOPS, the Model 433s provides integer performance up to 120% of the Model 400s and floating point speed that is nine times greater. The desktop Model 433s has been designed for high-performance graphics-intensive applications. Through the PersonalVRX or TurboVRX graphics systems, the Model 433s can provide powerful color representations of 3D wireframes, solid renderings and animation. Features to configure specific systems solutions include a choice of EISA, DIO II, SCSI, mass storage and networking options.

### The HP 9000 Series 800

The Series 800 Models 834 and 835 offer the performance of PA-RISC Architecture at a very affordable price. Delivering up to 14 MIPS and 2.02 MFlops, these VLSI-based workstations speed through a variety of applications, including graphics, engineering analysis and modeling. Up to 1600 applications are currently available worldwide. The Series 800 provides the power to support HP's accelerated SRX and TurboSRX 3D color graphics systems.

### Model 834

The Model 834 is the entry-level PA-RISC workstation. It delivers affordable performance and software support for floating point-intensive and RAM-intensive applications as well as support of HP's accelerated 2D and high-end 3D graphics systems. With 14 MIPS of power and 8 Mbytes of ECC RAM expandable to 96 Mbytes, the Model 834 provides high performance at a reasonable price.

### Model 835

The Model 835 uses the 32-bit, 15MHz PA-RISC CPU with a floating-point coprocessor. It provides the same performance as the Model 834, but with added expandability. For applications diverse as high-end ME-CAD to compute-intensive numerical analysis, the Model 835 provides plenty of power and performance. It includes a high-resolution 19-inch color monitor and supports the SRX and TurboSRX graphics systems.

### The HP 9000 Series 300

The HP 9000 Models 340, 345 and 375 workstations are based on the MC68030 processor and its companion MC68882 floating point processor. The Series 300 workstations offer mid-level performance ranging from 4 to 12 MIPS. The Series 300 provides for systems expansion, I/O, high-resolution displays and SRX and TurboSRX graphics accelerators. For more information on Series 300 controllers, see page 605.

### Ordering Information

### Price

#### HP Apollo 9000 Series 400

HP-UX Bundles		
HP A1630B	Model 400dl VRX Mono (no HP-IB)	\$4,890
HP A2000A	Model 400t VRX Mono	\$10,240
HP A2001A	Model 400t VRX Color	\$15,640
HP A2002A	Model 400t PersonalVRX P2	\$26,890
*	Model 425t	*
HP A2020A	Model 400s VRX Mono	\$26,080
HP A2021A	Model 400s VRX Color	\$29,680
HP A2022A	Model 400s PersonalVRX P3	\$45,880
HP A2023A	Model 400s TurboVRX T2	\$83,680
HP A2024A	Model 400s Server w/3 DIO II slots	\$38,520
*	Model 433s	*

Domain Bundles (400t & 400s include 19" monitor; 400s also

includes 4 ISA slots, 1/4" QIC Tape Drive)		
HP A1630B	Model 400dl VRX Mono	\$4,890
HP A2010A	Model 400t VRX Mono	\$10,240
HP A2011A	Model 400t VRX Color	\$15,640
HP A2012A	Model 400t PersonalVRX P2	\$26,890
*	Model 425t	*
HP A2030A	Model 400s VRX Mono	\$27,880
HP A2031A	Model 400s VRX Color	\$31,480
HP A2032A	Model 400s PersonalVRX P3	\$47,680
HP A2033A	Model 400s Server	\$38,730
*	Model 433s	*

#### HP 9000 Series 300

HP 98563E	Model 340 M	\$5,495
HP 98563G	Model 340 MH	\$7,995
HP 98564C	Model 340 C+	\$8,495
HP 98564G	Model 340 CH	\$10,995
HP 98573C	Model 340 SRX	\$14,900
HP 98563H	Model 345 MH	\$8,995
HP 98564H	Model 345 C+	\$12,495
HP 98578H	Model 345 CH	\$14,995
HP 98573H	Model 345 SRX	\$19,995
HP 98573J	Model 345 TurboSRX	\$23,995
HP 98589J	Model 375 MH	\$21,995
HP 98583J	Model 375 C+	\$22,995
HP 98588J	Model 375 CH	\$25,495
HP 98587J	Model 375 SRX	\$33,495
HP 98587K	Model 375 TurboSRX	\$39,995

#### HP 9000 Series 800

HP A1056A	Model 834 CH	\$22,500
HP A1089A	Model 834 SRX	\$34,900
HP A1091A	Model 834 TurboSRX	\$37,900
HP A1050A	Model 835 CHX	\$59,500
HP A1045A	Model 835 SRX	\$69,500
HP A1055A	Model 835 TurboSRX	\$63,500

\*Prices and order numbers unavailable at printing - contact local HP sales office

2D graphics options for Series 300 and 800 workstations:

- M - entry-level monochrome 17" medium-resolution monitor
- MH - high-performance (1280 x 1024) monochrome 19" monitor
- C+ - mid-range (1024 x 768) color 16" or 19" monitor
- CH - high-performance (1280 x 1024) color 16" or 19" monitor
- CHX - accelerated color display controller and graphics accelerator

2D graphics options for Series 400 workstations:

- VRX Mono - high resolution monochrome (1280 x 1024), 19" monitor
- VRX Color - highly versatile, high-resolution color (1280 x 1024), 16" or 19" monitors

3D graphics options for Series 300 and 800 workstations:

- SRX - entry-level 3D with display controller and graphics accelerator
- TurboSRX - high-performance 3D controller and graphics accelerator

3D graphics options for Series 400 workstations:

- PersonalVRX - Affordable desktop CAD/CAE 3D color, (1280 x 1024), 16" or 19" monitors
- TurboVRX - High-performance 3D modeling & rendering system, (1280 x 1024), 16" or 19" monitors

For help in configuring the best system for your needs, please contact your local HP sales office.

UNIX is a registered trademark of AT&T in the U.S. and other countries. MC68040 performance ratings are based on Motorola data.

# TECHNICAL COMPUTER SYSTEMS

## HP 1000 Computers for Real-Time Applications

- Computer-aided manufacturing
- Computer-aided test
- Real-time monitoring and control
- Real-time data acquisition

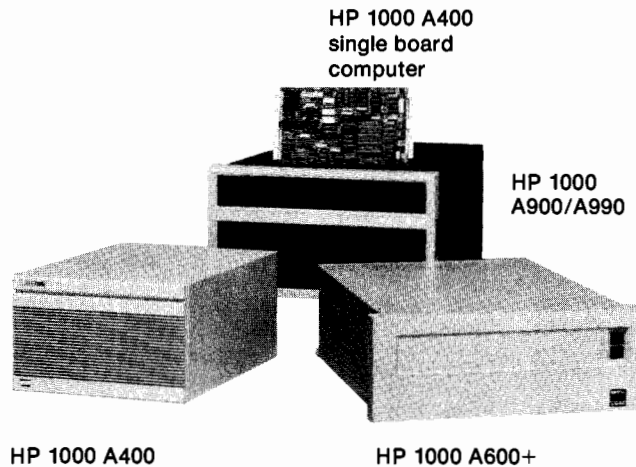

HP 1000 A400

HP 1000 A600+

### Versatile Design for Real-Time Applications

HP 1000 open architecture computers are modular machines that are designed for real-time multiprogramming, multi-user applications in manufacturing, communications, research, and other fields that require real-time response. A choice of processors and a wide variety of interfaces and software equips HP 1000 computers to solve many different applications, taking advantage of the following HP 1000 real-time performance features:

**Fast, efficient handling of I/O.** External sensors, measurement instruments, and other I/O devices connect to HP 1000 systems via I/O interfaces and an I/O system with multi-level, vectored hardware interrupts that expedite I/O. Each I/O channel has its own interrupt priority level, from which interrupts directly initiate service programs. Direct memory access controlled under a distributed intelligence I/O design speeds data transfers to and from memory with minimal involvement of the CPU.

**Fast processing of data.** HP 1000 systems can process data at base instruction rates up to 3.2 MIPS and floating point processing speeds up to 1650 KWIPS-B1D. This minimizes the time needed to process input data, evaluate results, and initiate real-time action.

**Clocked operations timing** is provided by time base generator interrupts that maintain a real-time clock.

**Large main memory capacity.** Up to 32 megabytes of main memory can be provided to keep most critical programs resident and ready to execute quickly, avoiding the delays inherent in moving programs to and from disc.

**A powerful real-time operating system.** The RTE-A system supports memory-based or disc-based real-time multiprogramming operation with easy, efficient inter-process communication, and priority-based scheduling of programs in response to event interrupt, time-of-day, program, or user requests. RTE-A manages sharable memory-resident data arrays up to 2 megabytes and virtual data arrays up to 128 megabytes in main memory and on disc. With its VC+ extension, RTE-A supports execution of programs as large as 7.75 megabytes.

### A Choice of Processors for Diverse Applications

Performance Level	HP 1000 Processor	Base Speed (MIPS)	Floating Point Speed (KWIPS-B1D)	I/O B/W Using DMA Mbyte/s CP
1	A400	0.4	120	4.3
	A600+	0.4	110	4.3
2	A900	1.3	820	3.7
3	A990	3.2	1650	4.2

**A400 minicomputer** packs a 0.4 MIPS CPU, double precision floating point firmware, 0.5 megabyte of memory, and a four-port serial I/O multiplexer on a single plug-in board computer (SBC). At a price close to what you'd expect to pay for a personal computer, the A400 SBC delivers full A-Series functionality, including support under the RTE-A real-time executive operating system and complete compatibility with all other members of the A-Series family.

**A600+ minicomputer** offers 0.4 MIPS base execution speed and double-precision floating point firmware. Unlike the A400 minicomputer, the A600+ can support ECC memory as well as parity memory. The A600+ processor consists of a CPU card and a memory controller card.

**A900 computer** incorporates a pipeline implementation and a cache memory scheme providing three times the base performance of the A400/A600+ computer and over seven times the floating point performance. The A900's floating point processor and scientific and vector instruction sets are built-in. ECC memory is standard for maximum system integrity. The five-board A900 is the ultimate computation machine designed to meet the most demanding needs of OEMs, system designers, and end users.

Customers upgrading from A400, A600+, or even the obsolete A700 computers to A900s can receive trade-in credit toward the purchase of the A900s.

**A990 - a new single board processor** - has been developed for customers who require even more performance than that provided by the A900. In addition to more than doubled base speed and floating point speed, the A990 also provides increased I/O bandwidth, and significantly improved memory cycle time. Additionally, the A990 is available in the same package configurations as the A900.

This new processor enlists modern CAD/CAM techniques, utilizes the latest in applications-specific-integrated-circuits (ASICs), and combines the state-of-the-art surface-mount (SMT) processes with other modern manufacturing methods to provide a high-performance, plug-compatible, and reliable single-board processor that is functionally compatible with the current A-Series family.

For those applications where speed is critical, the A990 with its standard on-board writeable control store, is also user-microprogrammable.

Customers who already have A-Series computers can field-upgrade to the new A990 processor by purchasing the 12990B upgrade package. Also, for returning their A-Series processor board set when they order their upgrade, customers will receive trade-in credit.

**Exceptional applications flexibility.** Programs can be developed on any member of the A-Series family and executed without change on any other member, from the A400 on up through the A990. Processing power, capacity, and cost can be closely matched to application requirements with the guaranteed ability to grow as and whenever necessary.

### Flexible Packaging — from Board Computers to System Processor Units

HP 1000 A-Series processors are available in a variety of packaging configurations to meet the requirements of many different applications. see the photo on the next page and summary below.

Processor	A400	A600+	A900	A990
Board Computer	12100A	2106CK/DK	Not Avail.	12990B (Upgrades only)
Micro 14/16 6-Slot Box Computer	2424A	2426G/H	Not Avail.	Not Avail.
Micro 24/26/29/99 14-Slot - Box Computer - System Proc. Unit	2434A 2484B	2436G/H 2486B/C	2439B 2489B	2939A 2989A
20-Slot Box Computer	2134A	2156C/D	2139B	2959A
Model 26/29/99 System Proc. Unit	Not Avail.	2196G/H	2199E	2999A

**Board computers** make the A400 and A600+ processors available to OEMs or system designers in a space-conserving package for embedded controller applications, or other uses in which custom integration is required to either fit within defined physical constraints or to meet cost objectives.

**Box computers** incorporate the CPU card(s) and memory in a fully-powered card cage that can be installed in a rack cabinet. Because a system console and system disc are not prerequisite to purchase, the box computer offers OEMs and system designers more configuration flexibility than the System Processor Unit.

**System processor units (SPUs)** include a box computer, interface to the system disc, the RTE-A operating system and diagnostics, site prep consultation and installation/checkout services, and 90-day on-site warranty. The higher level of SPU integration simplifies design, ordering, and implementation of systems that use a system console and a system disc. The SPU also complies with FCC and VDE EMI regulations.

**Micro 14/16 box computer** provides the A400, or A600+ processor in a low-cost 6-slot box for low-end systems. Exceptionally efficient cooling makes possible operation in ambient temperatures to 60°C. This and a 1.5G operating shock spec make the Micro 14/16 ideal for use in tough environmental conditions.

**Micro 24/26/29/99 box computer or System Processor Unit** provides the A400, A600+, A900 or A990 processor in the versatile 14-slot Micro/1000 package. The Micro/1000 package can be placed on a table or bench, installed in a space-saving vertical floor mount with roll-about mobility (as shown in the photo above), or rack-mounted in a larger cabinet. In addition to its compactness and convenience, the Micro/1000 package can incorporate integrated mass storage (a 20 megabyte mini Winchester disk and a 630 kilobyte diskette).

**20-Slot box computer** provides the A400, A600+, A900, or A990 processor in the largest available package for applications that need more card cage slots than the Micro/1000 package provides.

**Model 26/29/99 system processor unit** provides either the A600+, A900 or A990 processor in the 20-Slot box configuration that is intended to be rack mounted in either a tall or a short rack cabinet (HP 29431G or HP 29429A, respectively).

### High Density Memory

HP now offers HP 1000 memory that uses 1 Mbit DRAMs: Available are 2, 4, and 8 megabyte parity memory boards for the A400 and A600+ computers, and an 8 megabyte ECC memory board for the A900 and A990 computers. Four 8 Mbyte memory boards can provide 32 megabytes of memory for A-Series computers or SPUs.

A400 and A600+ computers typically incorporate the less-expensive parity memory as the preferred memory system. For large systems in critical applications, Error Correcting Code (ECC) memory, which detects and corrects all single-bit errors and detects all double-bit errors to provide the best possible system integrity is preferred. All A900s and A990s utilize ECC memory. ECC memory is optional for the A600+.

### HP 1000 Software

HP 1000 software products for program development, data base management, graphics, distributed systems networking, quality decision management, programmable controller communications, and process monitoring and control are supported in all HP 1000 A-Series computers. This universality of HP 1000 software helps you to tailor comprehensive, coherent solutions to your specific application needs. Further help is available from a growing array of HP 1000 software products offered by third party suppliers under the HP PLUS software program.

### Program Development

With a hard disk and optional software, HP 1000 systems can be used to develop programs in BASIC, FORTRAN 77, Pascal, and Macro/1000 assembly language. Symbolic Debug/1000, program profiling, and user microprogrammability (of the A900 and A990 processors) provide extra capability that can be used to gain extra performance.

### Computer Networking

HP's AdvanceNet software makes it easy to connect HP1000 systems across a city or a continent, sharing vital information throughout the network. LAN link is now available for fast local area communications with other HP systems or with DEC VAX systems.

### Compatibility with HP 9000 Series 800 Systems

PORT/RX applications migration consulting services are available from HP to promote compatibility of the HP 1000 systems with HP 9000 Series 800 systems. Multiple HP 1000 systems used as factory floor cell controllers can thus benefit from supervision and support by HP 9000 Series 800 systems used as Area Managers at Level 2 in the CIM hierarchy, or in similar supporting host roles.

### Plant Automation

HP's wide range of hardware and software supports automation of instruments and machines as well as monitoring and control of real-time processes. The HP 1000 can help improve productivity and reduce costs. For low point-count data acquisition, A-Series measurement and control cards provide many analog interfacing functions within the computer, without need for add-on peripheral devices.

### Automated Test Systems

HP Automated Test Systems can be configured from HP 1000 A-Series computers and a wide range of electronic instruments to perform virtually any electronic test application.

### Prices

Range from \$2600 for an HP 12100A A400 single board computer with 0.5 Mbyte parity memory and four-port multiplexer to approximately \$50,000 for an HP 2989 A990 Micro/1000 system with 3 MB ECC memory, RTE-A/VC+ operating system, 20 MB integral disk, and system console connected via an eight-port multiplexer.

### SCSI Interface Card

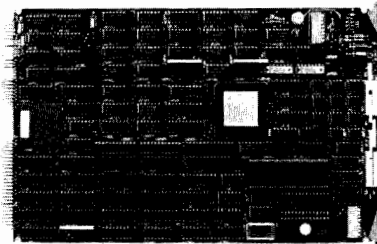

Provides cost effective, large capacity disk, tape, and optical storage solutions for the HP 1000 A-Series Computers

### HP 12016A SCSI (Small Computer Systems Interface)

The HP 12016A SCSI interface provides connection to the industry-standard SCSI I and SCSI II peripheral interfaces for fast, efficient handling of I/O. Up to seven devices, including flexible and hard magnetic disk drives, optical disk drives, and magnetic tapes, can be connected to the HP 12016A.

In addition to those previously mentioned, other important features the 12016A provides include:

- Interface that is compatible with all HP 1000 A-Series computers and systems
- Interface to HP and non-HP low-cost SCSI peripherals
- Built-in DMA capability for optimum I/O efficiency
- DMA transfer rates up to 2.4 MBytes/second to both HP and non-HP SCSI peripherals
- Concurrent operation of multiple SCSI interfaces under control of the RTE-A operating system
- Factory supported design environment for custom device drivers
- Supports cable lengths of 6 meters for single-ended operation, and 25 meters for differential operation

HP 12016A reliability is supported by a calculated MTBF of greater than 50,000 hours.

A diagnostic kit for the 12016A is provided with the 12016A SCSI Interface.

The U.S. list price of the 12016A SCSI Interface is \$1,495

# TECHNICAL COMPUTER SYSTEMS

## HP 9000 Technical Computers

### The X Window System

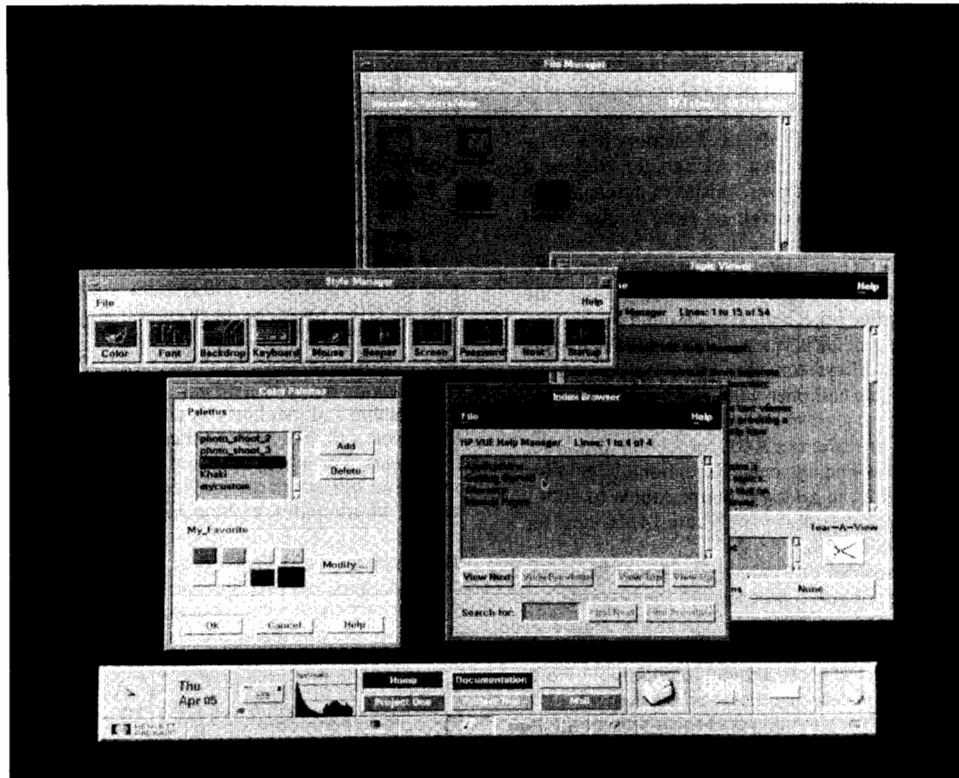

### The X Window System

The X Window System provides HP Series 300, Series 800, and Vectra PC family with a network-compatible windowing system that allows interconnection of HP computers and computers from other vendors.

With the X Window System, you can create multiple windows on your computer display to interact with programs running on your computer, another HP computer, or computers from other vendor's, connected to your system over a network. Programs compiled on another vendor's computer to use X can use the X windowing software on HP computers for input and output - and the reverse.

### User Interface

HP-UX supports the X Window System Version 11 Release 3 (referred to as X), which provides a window system for the HP9000 Series 300 and Series 800 computers. X includes the display server, a group of programs (clients), a library of functions (Xlib), and a standard tool kit (X Toolkit Intrinsics) for constructing applications.

The HP OSF/Motif™ user environment\*, HP's offering of the OSF/Motif user environment, is included as HP's standard user interface on all of HP's open-systems products. The OSF/Motif environment is based on MIT's X Window System and is consistent with Presentation Manager behavior, the de facto standard for behavior in the PC world. The OSF/Motif environment provides a consistent behavior for the user interface. By providing consistent behavior, user productivity is maintained as people move from system to system and application to application. (Imagine what driving a car would be like if the steering wheel and pedals changed functions from model to model.

The HP X Window System also allows programs written in the GKS, Starbase, and other graphics libraries to have full access to HP graphics capabilities, thus combining the power of these graphics libraries with an easy-to-use interface.

### X Window Systems for a Wide Range of Systems

HP X Window System products are available for the HP 9000 Series 300 and Series 800 computers, as well as for the HP Vectra PC. The AXDS/PC X11 product for the Vectra PC runs on the Intelligent Graphics Controller card. This software provides the display and input functions of X11 and can integrate the Vectra into the X environment.

\*Certification of conformance with OSF/Motif user environment pending.  
OSF/Motif is a trademark of the Open Software Foundation, Inc. in the U.S. and other countries.

Because X Window Systems are supported on a wide price/performance range of hardware platforms, application developers can have a broader platform base for their applications, and end users enjoy more freedom and flexibility in their choice of hardware.

### Hewlett-Packard Visual User Environment (HP VUE)

HP VUE is a graphical user interface designed to make workstations easy and natural to use. Through the use of window-based, mouse-driven functionality and a simple, flexible set of window-based utilities, HP VUE gives workstation users increased productivity without compromising the full power of the HP-UX operating system.

### For More Information

Please contact your nearest HP technical sales representative.

### Ordering Information

	Price
<b>Vectra PC Family (PC-AT bus compatible)</b>	\$500
D2300A AXDS/PC	
Accelerated X Window display server software for the PC with X11 R2/R3 fonts on 5.25-inch and 3.5-inch media and installation guide. Requires the Intelligent Graphics Controller card, part number HP 82328A.	
<b>Series 300</b>	
X Window System is included as part of Series 300 X11	N/A
<b>Series 800</b>	
<b>B1168A X Window System Version 11</b>	
OPT AH0 for model 815	\$1,000
OPT AEL for model 815/822	\$1,000
OPT AE5 for model 825/832	\$2,100
OPT AE6 for model 835	\$2,100
OPT AEN for model 840/845	\$3,295
OPT AEP for model 850/855	\$4,500
OPT AH1 for model 875	\$5,775
<b>Must also select a no-charge media option:</b>	
OPT AAO 1/4 inch tape cartridge	
OPT AA1 1/2 inch 1600 cpi 9-track tape	
OPT AAH DigitalData Storage Tape	

### Design Automation

Design automation is the process of using computer-automated productivity tools to improve the quality of new products and the speed with which they can be moved through the design cycle and into manufacturing. When implemented effectively, design automation has a powerful, positive effect not only on quality and time to market, but on production costs, product reliability, and other factors that ultimately affect the competitive position and profitability of your company.

Hewlett-Packard's approach to design automation is to integrate best-of-class applications into a design environment that enables engineering teams to link their efforts through the entire design process, from concept through manufacturing. HP solutions comprise HP Apollo computer platforms and operating environments, application software from HP and value-added businesses, networking, peripherals, hardware service, software support, and consulting.

### HP Open DesignCenter

HP Open DesignCenter is an integrated design environment for electronic, mechanical, and software engineers, where tasks can be planned, executed and managed more effectively. HP Open DesignCenter includes tools for data management, documentation and communication, not just design automation software. It runs on a family of powerful workstations that link, through industry-standard networks, to computers from Hewlett-Packard and other vendors.

In addition to offering integrated sets of tools from Hewlett-Packard and from value-added businesses, the HP Open DesignCenter environment provides assistance for mixing a variety of alternative tools to fit in with standards-based design automation installations.

### HP Design Automation Products

HP Technical Computer Systems 640

### HP Open DesignCenter Software Engineering Products

HP SoftBench 655

HP Encapsulator 656

HP 64000 AxCASE Embedded

Microprocessor Development Environment 648

HP 64700 Series Emulators/Analyzers 648

### HP Open DesignCenter Electronic Engineering Products

HP Open DesignCenter Electrical Engineering Products

HP Electronic Design System 657

HP Printed Circuit Design System 658

HP Design Data Controller 658

HP Programmable Logic Device Design System 659

HP Engineering Graphics System 659

HP EDA Solutions 660

HP Microwave Design System 661

### HP Open DesignCenter Mechanical Engineering Products

HP ME Series 10 & 30 662

ME Value-added Business Products 664

### HP's Engineering Solutions

Hewlett-Packard's engineering solutions comprise five enabling tiers: HP's leadership, best engineering practices, computing platforms, team computing, and engineering applications.

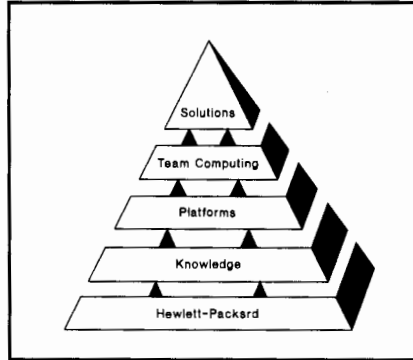

Five Tier Approach to Delivering HP's Engineering Solutions

### Strong Foundation

Hewlett-Packard's engineering solutions rest on a foundation of over 50 years of experience in supplying tools to engineers. This foundation is represented by HP's leadership in standards and quality.

### Sharing HP's Best Practices

HP takes their expertise and experience and applies it to the design automation solutions we recommend. In order to help customers improve their own engineering and manufacturing processes, HP offers to share

their experience and knowledge through technology seminars, consulting services, and user training courses. See your local Hewlett-Packard sales representative for more information on these programs.

### Computing Platforms

HP Open DesignCenter solutions build on the strong foundation HP provides with a commitment to delivering standards-based computer technology for heterogeneous environments. Hewlett-Packard platforms include HP Apollo workstations, high performance servers, X terminals, printers, plotters, disks, personal computers and multi-user systems. A broad range of operating systems is available, including UNIX systems, Domain, and MS-DOS.

### Team Computing

HP takes their computing platforms a step further with a set of system administration tools which provide increased communication, resource optimization, and a common user interface, realizing true team computing.

### Applications from HP and Value-added Businesses

Hewlett-Packard offers a broad line of engineering solutions, both HP-developed and from value-added businesses. There are more than 3200 applications available on HP computer platforms from over 1100 independent software vendors. The HP sales and support force works closely with these suppliers to match the right solution with each customer's needs. See page 660.

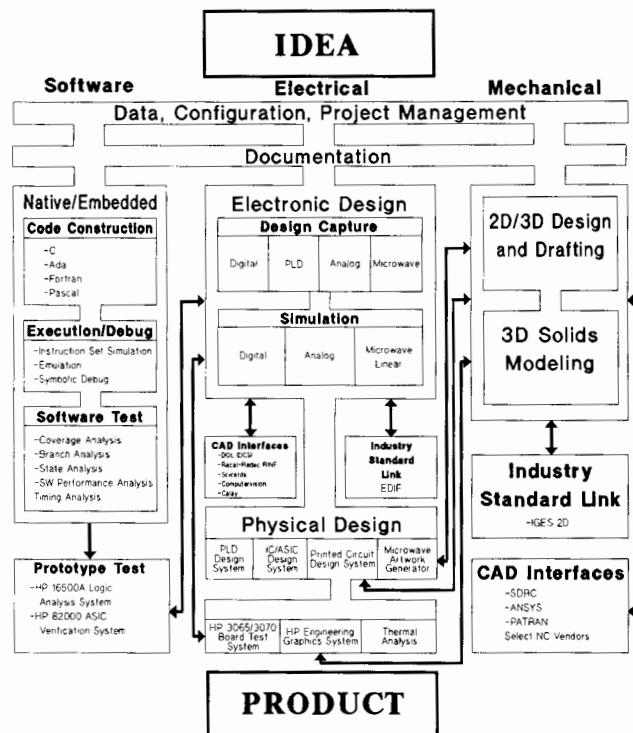

HP Open DesignCenter CASE/CAE/CAD Solutions

# DESIGN AUTOMATION

## HP Open DesignCenter

### General Information

#### CASE Products

**HP SoftBench** is a tool integration platform that includes a set of integrated software development tools that facilitate rapid, interactive program development in a distributed computing environment. HP SoftBench is easy to learn, easy to use, and it simplifies the tasks of program porting and maintenance. A language-sensitive editor and program building tool help in writing source code and then compiling it into an executable program. A symbolic debugger and static code analyzer are used to gain an in-depth understanding of that program. The version management tools allow you to manage the software throughout the development process.

**HP Encapsulator** allows UNIX tools and third-party tools to integrate into the HP SoftBench environment. The environment can be customized by using HP Encapsulator to establish communication links between HP SoftBench and user added tools. The result of this encapsulation process for the new tool is a consistent user interface based on the OSF/Motif appearance and behavior. See page 655.

**HP 64000 AxCASE Microprocessor Development Environment** is a set of integrated tools for embedded system development. These tools provide support for the entire software life cycle. The HP 64000 environment is fully integrated into the HP Open DesignCenter family and the HP SoftBench environment, uses the same computer platform, and provides links to other HP Open DesignCenter solutions. It provides versatile networking to popular software on systems such as the DEC VAX, HP 9000 Series 300 and 800 workstations, and Apollo workstations. In-circuit emulators, language systems, and analysis tools are available for 8-, 16-, and 32-bit microprocessors. A broad selection of price/performance options helps to select the best system for your needs. See page 648.

Included in the HP 64000 environment are HP 64700 Series emulators/analyzers, which are self-contained, host-independent tools. They can fit into virtually any development environment by means of an RS-232 connection. A firmware-resident terminal interface provides access to the emulator features. The HP 64700 Series can also be interfaced to IBM-PCs and compatibles as well as HP 9000 Series 300 and Apollo workstations. Hewlett-Packard and key language tool vendors provide support for the full development life cycle with cross compilers, cross assemblers/linkers/librarians, cross debuggers, simulators, and test coverage analyzers. Eight- and 16-bit processors are probed with slim, flexible cables ending in a low-profile probe for accessing hard-to-reach targets without sacrificing signal fidelity.

Thirty-two-bit designs use HP's active probe technology to allow you to design with emulation. See page 648.

#### Electronic CAE/CAD Products

**HP Electronic Design System** provides integrated tools for all phases in the development of digital, analog, and microwave circuitry. The system includes more than 7000 logic and analog component library parts, a powerful schematic editor. System HILO® logic simulation, analog simulation through the Analog Workbench, links to the HP 16500A prototype test, to HP's PLD Design System, and to physical layout systems, and a user interface that simplifies interaction with the design and verification tools. The HP EElectronic Design System is available as a high-end system for use on the HP 9000 Series 300 technical workstations. See Page 657 HP Apollo 9000 Series 400.

**HP Printed Circuit Design System** couples printed-circuit-board layout to electrical engineering design, manufacturing and test. Tightly coupled with HP's Electronic Design System, the Printed Circuit Design System allows PCB designers to create highly manufacturable boards that perform as the design engineer intended HP Printed Circuit Design System provides packing, placing and routing features to automatically lay out digital, analog and mixed digital/analog boards with through-hole and surface-mount technologies, with facilities for thick-film hybrid design. The system has links to HP's ME Series products and to schematic capture systems from a variety of EDA vendors. The system also generates a complete range of manufacturing and test reports. See page 658.

**HP Design Data Controller** provides flexible data management and file security for HP Electronic and Printed Circuit Design System data. This data includes schematic drawings, simulation stimulus and results, documentation, board layout graphics, back annotation and engineering changes, material lists, and manufacturing and tooling files. Large design teams can keep track of data revision, control access to files, and lock data at project checkpoints to prevent unauthorized or unsynchronized updates. The HP Design Data Controller is available on HP 9000 Series 300 and 800 computers, and HP Apollo 9000 Series 400. See page 658.

**HP's Programmable Logic Device Design System** is a device-independent design tool that supports the entire design process of Programmable Logic Devices (PLDs) — from conceptual and functional design, through device selection, pin/resource assignment, to debugging and fusemap generation. The system automatically fits designs into the most efficient PLD and

automatically partitions large designs into multiple PLDs to shorten design time. A bidirectional link with HP's Electronic Design System allows schematics to be transferred to the HP PLD Design System for PLD realization. Once the design has been fitted into one or more PLDs the system will automatically generate system HILO. models for design verification on the HP Electronic Design System See page 641.

**HP Microwave Design System** is a powerful tool for designers of hybrid- and microwave-integrated circuits. The system consists of three fully integrated modules for schematic entry of the circuit, linear-circuit simulation and optimization, and circuit-artwork generation. Extensive capabilities for documenting the design also are integrated into the program. The system also links to other HP electronic- and mechanical-engineering design systems. See page 661.

**HP Engineering Graphics System (EGS)** provides powerful tools for thick-film hybrid circuit design, interactive printed circuit board layout and schematic drawing, as well as mechanical drafting for the enclosures to house PCB designs. The product also includes a general drawing module for artwork such as overhead slides, project planning diagrams and floor plans. HP EGS can be easily customized to perform specialized CAD tasks. See page 659.

**HP EE test solutions** are the most highly rated in the business. HP is a leading supplier of logic analyzers, digitizing oscilloscopes, radio and microwave frequency sources and analyzers, low-frequency dynamic signal analyzers, board test systems and other products. See the alphabetical index of this catalog for the specific instruments of interest to you.

#### Mechanical CAD/CAM Products HP ME DesignCenter Series 10 & 30

**Mechanical Engineering Systems** are a family of CAD products for mechanical drafting, 2D design and 3D solids modeling. Both use the same user interface, developed to dramatically reduce system learning time to quickly improve designer productivity. ME Series 10 & 30 provide a range of functions for design through modeling and drafting of complex mechanical parts and assemblies. The result is reduced prototyping requirements and faster creation and modification of drawings. See page 662.

**HP Mechanical Engineering Test Products** have grown out of the company's longstanding involvement with state-of-the-art instrumentation for vibration and structural analysis and test. In addition to CAD/CAM products, HP offers a large family of mechanical testing solutions. See page 157.

UNIX is a registered trademark of AT&T in the U.S.A. and in other countries.

## Lots of Links

Ideally, a new product design should work right the first time, but many companies average six iterations. Integration is the key to reducing the number of times designs must be reworked. HP Open DesignCenter products can be tightly linked (see diagram on page 645). HP Electronic Design System provides strong links to HP Technical Office Automation, HP EGS, HP 64000 AxCASE Microprocessor Development Environment, HP Printed Circuit Design System, and the HP Programmable Logic Device Design System, with additional links to Racal-Redac Visuala, and ASIC foundry links to NEC, Motorola, TI and others. HP Printed Circuit Design System not only receives net lists and parts information from HP Electronic Design System, but sends back engineering changes and back-annotation data.

## Design Automation A Strategic Decision

The purchase of any computer system is an important decision that requires looking beyond today's needs and currently available product features to expected future requirements and growth paths. This is especially true in CASE/CAE/CAD/CAM since the user's entire design-to-manufacturing cycle can be linked to the selection of a CAE vendor. With technology and design requirements changing at an ever-increasing pace, the strategic directions of alternative CAE vendors are an important factor in the selection process. HP's product strategy is founded on a major corporate commitment to the design automation business. The company's engineering expertise, reputation for quality and experience in test, measurement and technical computing, as well as its respected worldwide support organization, all contribute to HP's position as a leading supplier of design automation solutions.

With the HP Open DesignCenter, an engineer has access to a comprehensive offering of CASE/CAE/CAD/CAM solutions for electronic, mechanical and software development. Along with this comes the support, training, and service that have distinguished Hewlett-Packard over the years, and that are so important to the successful use of these complex systems. To ensure that the best solutions are available to customers, HP cultivates relationships with other design automation market leaders to make their products available on HP computer systems. This combination of the HP Open DesignCenter offerings complemented by renowned third-party products, provides the customer with the widest possible range of design automation solutions.

HP is committed to a technical and business relationship with CASE/CAE/CAD/CAM customers, which begins when the HP field engineer helps to define and analyze the customer's specific needs. This continues through system installation and implementation and extends through the life of the system and beyond as needs expand and new products become available.

### Contact HP

HP's design automation offerings are continually expanding as new products are introduced at a rapid pace. The products on the following pages represent the current state of the HP Open DesignCenter family, but are by no means the whole story.

Contact your nearest Hewlett-Packard sales office (see page 737) for more detailed information on HP's growing family of products for design automation solutions in CASE/CAE/CAD/CAM.

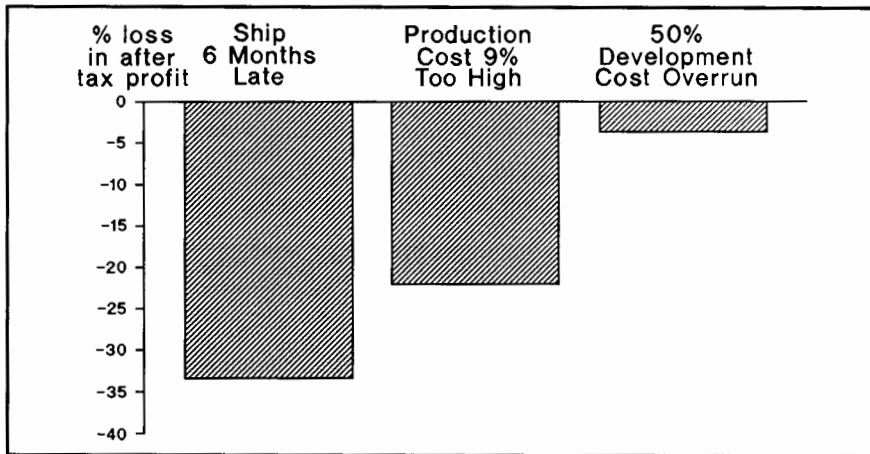

## Sensitivity of Profits Over Product Life

### Why Design Automation?

During the past few years, several factors have influenced the typical product design process in ways that make the design engineer's task more demanding. Increasing global competition has compressed product development time as well as product life cycles, making the time saved in development even more critical than in the past.

The shorter the development time, the sooner the product goes to market and the longer the sales life of the product. A recent electronics industry study compared the impacts on product costs and late product introduction.\* Using a representative high-growth market with 5-year product life, 12% annual price erosion, and 20% growth per year, an overrun of 50% in product development costs will decrease after-tax profits by 3.5%. In contrast, a production-cost overrun of only 9% results in a 22% decrease in after-tax profits. Even more significant, a six-month delay in introduction costs 33% of the after-tax profits.

(\* Figure from Donald Reinstein, McKinsey & Co, Los Angeles, CA, Electronic Business, July 1983, P. 86 Copyright 1983, Cahners Publishing Company)

### Summary

Hewlett-Packard has for many years been a leading supplier of computers and engineering workstations for measurement automation, data acquisition, automatic test, factory automation and many other technical applications. Today, by combining its expertise in technical computers with its experience in state-of-the-art electronic design, HP supplies high-quality design systems to help improve the productivity of electronic, mechanical and software engineers.

Computer-aided engineering and design capabilities applied throughout the design cycle improve efficiency and quality at each step in the process and enhance communication and coordination between steps. With the increased capabilities and lower costs of technical workstations, peripherals, test equipment and application software, it is becoming feasible for every area of the factory to use these tools in collaboration so each can truly influence products in appropriate stages of design and development.

# DESIGN AUTOMATION

## HP DesignCenter

### HP 6400 AxCASE Microprocessor Development Environment

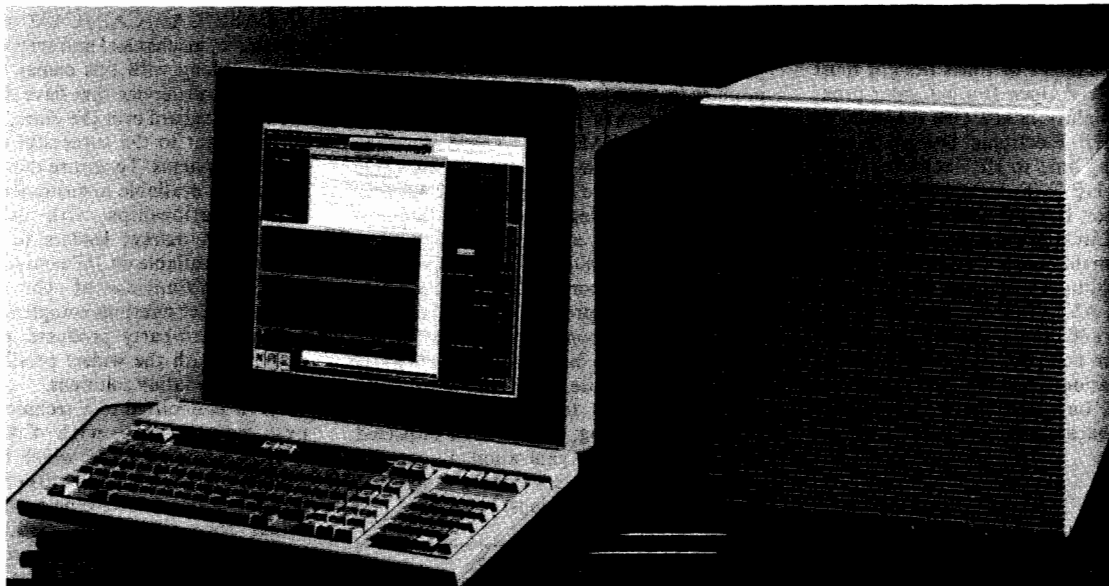

#### HP 64000 AxCASE Development Environment

The HP 64000 AxCASE development environment offers a powerful solution to the development of embedded microprocessor systems. The HP 64000 is a modular system that gives you the ability to select the subsystems needed for a cost-effective solution to your embedded microprocessor development application. With the HP 64000 environment you can select from single-user, real-time emulation on a terminal, PC, or workstation to large team installations with several HP 9000 series 300 workstations networked together to develop the software and hardware necessary for multiprocessor systems.

The HP 64000 is an effective solution for reducing the embedded microprocessor-based system design cycle. It combines advanced software development, real-time emulation for 8-, 16-, and 32-bit processors, sophisticated hardware and software analysis, and the power of the UNIX\* operating system. HP development solutions have been evolving to keep pace with the needs of embedded system design. HP AxCASE solutions are an example of HP's commitment to help you manage the ever-increasing complexity of your software development process. This integrated framework of powerful software development tools in an open environment enhances the entire development process.

An important part of the software life cycle support is the openness of the HP AxCASE environment. HP's support of industry standards for networking, such as ARPA and Berkeley services, NFS, and X Window System, makes it possible to integrate other vendors' tools into the HP development environment. HP workstations, Vectra PCs, and superminis can communicate easily with other computer systems — either from HP or other vendors --over the IEEE 802.3 LAN using ARPA and Berkeley services through the use of TCP/IP protocols.

The HP 64000 development system includes several significant features to help you better manage complex embedded systems designs. Structured analysis and design products are available to help in the specification of software systems for more accurate designs, and identify the correct modules and module interfaces for a system. Software

engineers benefit from the tightly coupled high-level HP development, debug, and analysis tools. Performance analysis and test verification tools quickly point to system bottlenecks allowing significant improvements in performance in a fraction of the time required using conventional techniques. Powerful, interactive, yet easy to use emulation and integrated logic analysis speeds hardware development.

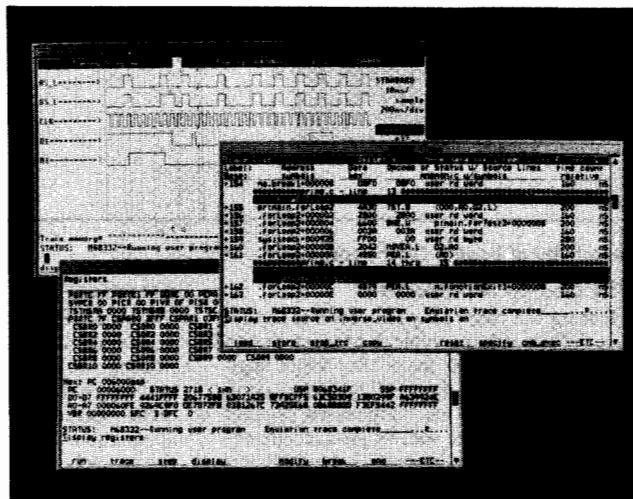

When hosted on the HP 9000 series workstations, the HP 64700 series emulators/analyzers allow you to view multiple emulation and analysis contexts simultaneously. In this example, a register display, timing diagram, and a trace list are present in separate X11 windows.



## HP 64700 Series Emulators/Analyzers

### Real-time, transparent emulation and analysis

HP 64700 series emulators/analyzers provide real-time, transparent emulation and analysis for popular microprocessors. The HP 64700 series emulators are self-contained emulation and analysis tools that can be controlled from a terminal, an optional HP 9000 Series 300-hosted softkey interface, or PC-hosted interface. This choice of interface, plus high-speed program download, makes for efficient microprocessor based system development.

### High Performance

- Real-time, transparent emulation at full processor speeds
- Triggering capabilities in an emulation bus analyzer support eight-level sequencing, time tags, prestore analysis for establishing software interrelationships
- An optional 16-channel external analyzer that can function as a fully independent 100 MHz timing analyzer as well as a 25 MHz state analyzer
- Synchronized operation and cross triggering between multiple emulators for multiple processor designs
- Real-time code coverage analysis for efficient, thorough software testing and design
- A high-speed RS-422 interface greatly improves emulator download and upload times
- Dual-bus architecture and dual-port emulation memory to ensure nonstop, real-time emulation
- Fully tested to rugged electrical, temperature, and shock standards to ensure continued reliability and performance
- Meets international requirements for RFI/EMI emissions

### Choice of Design Environments

HP 64700 series emulators/Analyzers offer several flexible configuration options. These host-independent emulation and analysis vehicles can be controlled from a simple terminal, or the emulator can be hosted on an IBM PC-compatible such as the HP Vectra PC. For large team-oriented or complex designs, the HP 64000-UX integration environment hosted on HP 9000 Series Series 300 computers provides a powerful development solution.

#### Terminal operation

A firmware-resident ASCII terminal interface is embedded in the emulator, supplying commands for all emulation and analysis features. Commands are ASCII strings; file transfers using industry-standard formats are accepted. Since a terminal can access these commands, host independence is realized. This interface is ideal for remote field applications, use of portable computers, field service, or other applications where a host is impractical or unavailable.

#### PC-hosted environment

A PC user interface for MS-DOS-based computers makes these emulation systems one of the easiest to use in the industry. Visually self-explanatory screens give you simplified access to best-of-class emulation and analysis features for any level of measurement complexity. Hierarchical command trees lead you quickly through your tasks.

A PC-based development environment provides the solution for the microprocessor software development and analysis needs of individual engineers and small design teams. High-performance tools include an IBM PC-compatible, HP 64700 series emulator, windowed user interface, combined with software development tools. These tools constitute a development environment tailored for small design teams and those desiring personal development systems.

HP's MS-DOS-based PC Interface windows provide views of several areas of interest at once, eliminating time wasted in repeatedly switching contexts or running commands. The interface supports color and monochrome displays and uses directed syntax with menus and submenus for quick selection of commands.

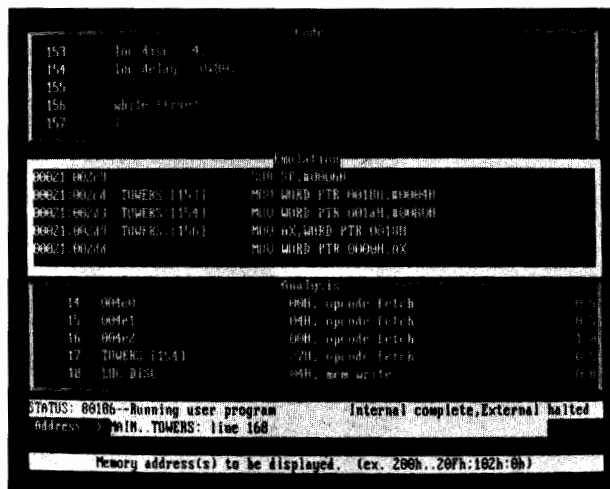

Source-line symbols help correlate memory and analysis displays with high-level code.

MICROPROCESSOR		HP 64120	HP 64170
AMD	80C521/80C321	■	■
	Am29000		
AT&T	DSP32C		■
Hitachi	HD6301V/6303R	■	
	HD6303R/X/Y	■	
	64180	■	
	647180X		■
	H16		■
	H8/330		■
	H8/520		■
Intel	8051/8751/8031	■	■
	8085	■	
	8086/8087	■	■
	8088/8087	■	■
	80186	■	■
	80C186		■
	80188	■	■
	80C188		■
	80C196		■
	80286/80C286		■
Mitsubishi	M7700		■
Motorola	6809/68A09/68B09	■	
	6809E/68A09E/68B09E		■
	68000	■	■
	68HC000	■	■
	68010	■	■
	68020	■	■
	68030	■	■
68332		■	
NEC	70116/70216	■	
	70108/70208	■	
	V25		■
	V25+		■
	V33		■
	V35+		■
	V53		■
National	V70		■
	78K2		■
	NSC32532/32GX32		■
	HPC16XXX		■
PACE	32FX16/CG16/CG160		■
	32GX320		■
	PACE 1750	■	
Texas Instruments	TMS320C25		■
Zilog	Z80		■

Summary of processors supported by HP 64000 microprocessor development system emulators

# DESIGN AUTOMATION

## HP DesignCenter (cont'd)

### HP 64700 AxCASE Microprocessor Development Environment

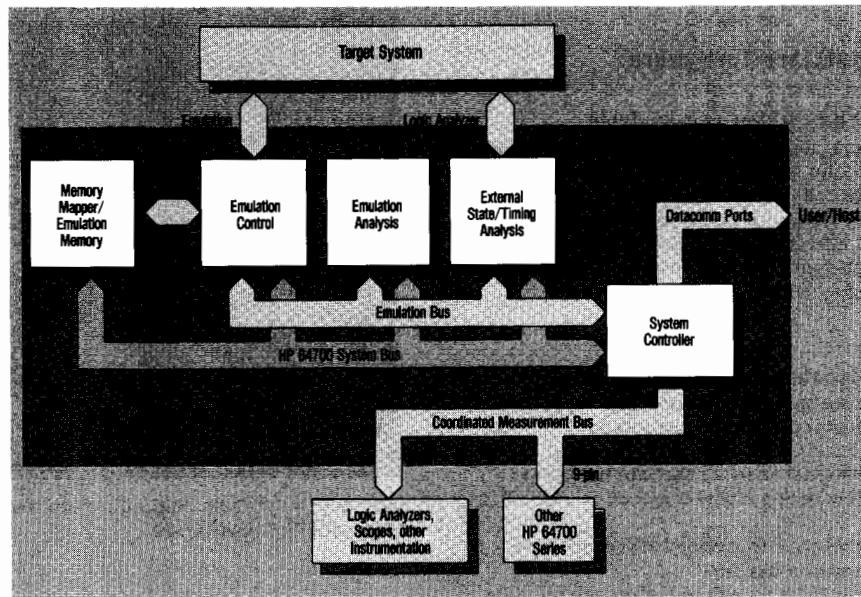

HP 64700 series emulators/analyzers have a dual-bus architecture with a foreground or background monitor to permit you to control the microprocessor emulation in the target system. This dual-bus architecture give you maximum transparency by allowing traces to be executed and displayed without halting processor execution.

#### Workstation interface

A softkey interface is available for interfacing to HP 9000 series 300 and HP/Apollo series 2500, 3500, 4500 computers. This development environment is geared toward team-oriented designs that need powerful hardware and software integration tools.

The softkey interface provides a simple means of executing commands for emulation and analysis functions. The interface works within the X Window System for simultaneous viewing of multiple emulation activities.

#### Emulation memory

Each HP 64700 series emulator contains an emulation memory that runs at maximum processor speeds with no wait states, for accurate duplication of target system performance. The dual-port memory allows emulation displays and modifications of emulation memory without halting the processor during emulation. Memory can be mapped in 256-byte, 512-byte, or 1-kbyte blocks, depending on the processor, and configured as either emulation or target RAM, emulation or target ROM, or guarded memory. The emulator checks for writes to ROM or guarded memory.

#### Popular File Formats

Popular absolute file formats are accepted by the HP 64700 series emulators — extended Tektronix hexadecimal, Intel hexadecimal, Motorola S record formats, HP absolute format, and Intel OMF-86, OMF-51 file format. The HP absolute format is a binary format that provides added upload and download speed over typical ASCII absolute file formats.

#### Advanced probe technologies

For quick, sure plug-in capability, 8- and 16-bit processors are probed with slim, flexible cables ending in a low-profile probe for accessing hard-to-reach targets without sacrificing signal fidelity.

Full signal fidelity is maintained at maximum-rated processor speeds so that you know your system analysis and processor control functions are accurate.

Multiple package types are supported where applicable. For example, both PGA and DIP packages for the Motorola 68000 along with LCC and PGA packages for the Intel 80186 are supported.

HP's active probe technology makes plugging into complex 32-bit designs significantly easier, allowing you to design with emulation, not around it. An active probe contains target CPU, memory, and high-speed circuitry for both functional and electrical transparency.

#### Comprehensive Logic Analysis

##### Emulation bus analysis

Each HP 64700 series emulator includes an emulation bus analyzer for tracing microprocessor code flow. Based on the same logic-analyzer-on-a-chip used in the HP 1650A/1651A logic analyzers and the HP 16500A logic analysis system, the analyzer has abundant resources for solving the most complex system problems. Up to eight hardware resources, each consisting of address, data, and status event comparators, can be combined in several fashions.

Those resources can be grouped to establish complex sequential trace specifications using "find A, followed by B..." constructs up to eight levels deep. A range comparator can be applied to address or data events at any one of the levels. Each event is tagged with an execution time, for easy measurement of code execution times. A dual-bus architecture allows all traces to be set up and reviewed without breaking processor execution.

A prestore function allows tracking of relationships between a given software element and one or more other software events that influence that element. For example, prestore helps pinpoint which of several different tasks accessing a variable is responsible for corrupting it.

Count	Address	Data	Count
0	00000000	00000000	0.000 s
1	00000001	00000001	0.000 s
2	00000002	00000002	0.000 s
3	00000003	00000003	0.000 s
4	00000004	00000004	0.000 s
5	00000005	00000005	0.000 s
6	00000006	00000006	0.000 s
7	00000007	00000007	0.000 s
8	00000008	00000008	0.000 s
9	00000009	00000009	0.000 s
10	0000000A	0000000A	0.000 s
11	0000000B	0000000B	0.000 s
12	0000000C	0000000C	0.000 s
13	0000000D	0000000D	0.000 s

STATUS: AxCASE - Running user program      Emulation trace running

Window: System Register      Memory      Config      Analysis

Begin    Halt    Run    Forward    Trace    Stop

A prestore function of the emulation bus analyzer can show the program areas that access a variable in a common data area that may be getting corrupted.



# DESIGN AUTOMATION

## HP DesignCenter (cont'd)

### HP 64000 AxCASE Microprocessor Development Environment

#### HP 64120/9000 Based Development Environment

One portion of the HP 64000 development environment is based on the HP 64120 instrumentation card cage that houses feature card sets for emulation, analysis, and PROM programming. The card cage with its subsystems is controlled using HP 9000 series 300/800 and Apollo workstations. Several card cages may be connected in a single system such that engineers can access different features from one or more card cages.

High-quality, real-time emulators are the core from which HP has evolved support for the microprocessor software development process. Full-speed execution of microprocessor code can be traced and analyzed nonintrusively with or without functional prototype hardware. Emulation of multiple processors makes possible interactive measurements and coordinated execution starts of complex designs.

#### Construct

With the definitions and outline provided by the structured design, your team can begin the actual writing of source code, such as C or Ada, using their favorite editors. For smaller, simple designs, the development process may begin at the code generation stage.

For C programmers, source code syntax is checked against draft ANSI standard C and compiled into highly space- and time-efficient executable code by HP's optimizing Advanced C Cross Compilers. Each microprocessor-specific compiler makes full use of the microprocessor's instruction set and address modes with features not available in most native compilers.

The quality and reliability of these compilers is ensured through a comprehensive process emphasizing object-oriented design and exhaustive testing with four independent test suites. Working tightly with corresponding assemblers and linkers, HP compilers generate symbolic code that is directly usable by debuggers and integration and test tools in the succeeding phases of the development cycle.

#### Integrate Software

HP's Advanced Cross Debug System provides clear insight into microprocessor programs from the beginning of coding through system integration. C and assembly code can be debugged simultaneously. In either view of the program the code, stack, and variables are displayed and updated at every step or break in execution.

Using the simulator, programs can be run and debugged without any hardware external to the host computer. When using the debugger with an emulator, your program runs full-speed on the real microprocessor with real memory. With in-circuit emulation, prototype memory is also available.

A powerful software test environment can be built using command files to run the debugger (in background) and using a journaling feature to record all input and capture the resulting output.

Simulated input/output capabilities of the HP 64000 integration tools provide access from inside the microprocessor to the active resources of HP-UX. This makes it possible to connect interactively with a running process such as the functions of a pictorial prototype of I/O devices.

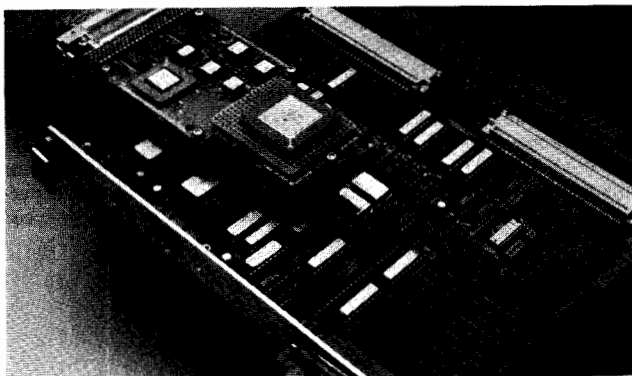

HP's active probe technology makes plugging into complex 32-bit processor designs easy. The active probe in this example contains a 68020 or 68030 CPU, a custom memory-mapping IC, memory, and the high-speed circuits necessary for full CPU support. This active probe offers both functional and electrical transparency.

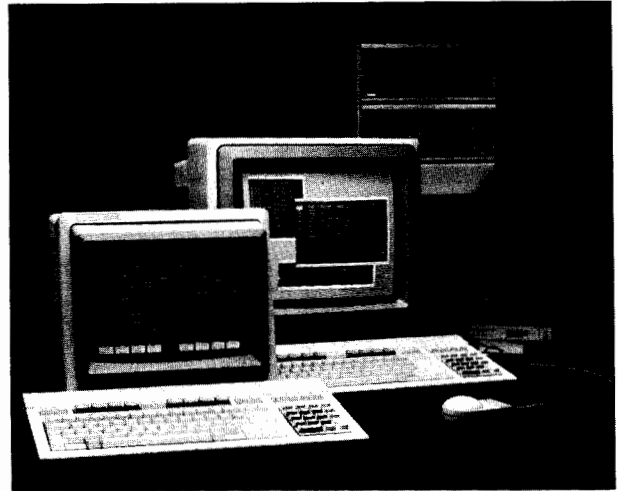

The HP 64000-UX Microprocessor Development Environment is a natural evolution of the HP 64000 family and is compatible with existing 64000 systems. The development environment offers many capabilities, and shares a common workstation platform with many HP DesignCenter products.

#### Emulation 8, 16, and 32 Bit

High-quality, real-time emulators are the core from which HP has evolved support for the microprocessor software development process. Full-speed execution of microprocessor code can be traced and analyzed nonintrusively with or without functional prototype hardware. Emulation of multiple processors makes possible interactive measurements and coordinated execution starts of complex designs.

Emulators provide an essential link between the software development environment and the target system. Programs developed on the HP 64000 development environment are run on the emulation subsystem for real-time debug and analysis. The HP 64302A emulation bus analyzer provides the displays and triggering conditions for the emulator and is the access point for interactive emulation/analysis. Processor run controls in the emulator allow you to single-step, display, and modify memory. Modifications and improvements to software are made quickly and easily in the early design phases; emulation gives you the flexibility to experiment before committing a product to firmware.

#### HP Branch Validator

HP branch validator is a software verification tool that is easy to use in the software verification process. HP branch validator, working through HP SoftBench, provides a complete environment for branch analysis that supports rapid reiteration of the compile-test-analyze loop. Comprehensive reports provide detailed feedback on the thoroughness of test suites. There are native and embedded versions of HP Branch Validator which are hosted on HP 9000 series 300 and series 800 computer systems.

A mouse-driven OSF/Motif interface allows for a rapid learning curve with minimal reference to manuals. The HP SoftBench environment provides a user familiarity that contributes to efficient use of tools and programmer satisfaction in creating a custom environment for software test. through the convenient use of menus and windows you can quickly focus the test suite on relevant sets of files and measure against the criteria for successful branch validation.

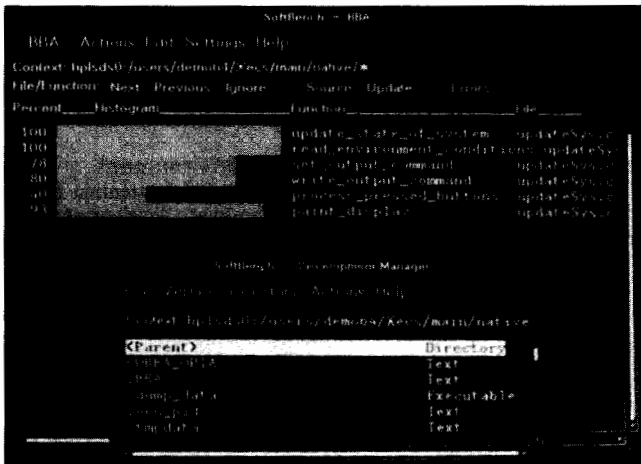

Branch analysis can be quickly scoped to the appropriate level with the click of a mouse button on desired options. Histogram summary information allows you to rapidly apply validation criteria to the function or file.

**Native development**

As an integrated part of HP CASEdge, the native version of HP Branch Validator takes advantage of the HP Softbench engineering environment to support development of HP-UX C language products. Both ANSI and non-ANSI versions of the HP-UX C compiler are supported.

**Embedded development**

As an integrated part of the HP AxCASE environment, HP Branch Validator supports AxLS C language for embedded microprocessor development applications. HP Branch Validator can use the actual prototype hardware with an emulator, running the program under test, to produce test metrics. This tool can also be used with an emulator running out of circuit or with a debugger/ simulator to develop software before the hardware is available.

**Software Performance Analysis**

Software performance analysis verifies and benchmarks both highlevel and assembly-level code, even whwn they are mixed. The software performance analyzer (SPA) can measure activity generated by your entire program (activity), find the most active modules and determine if they are being called too often (linkage), and measure how long any subroutine tekes to execute (duration). These measurements show where your optimization effort will yield the greatest benefit.

An additional advtage of SPA is its ability to show convergence when measuring, for example, the duration of a process. SPA calculates a measurement error tolerance level each time additional data are acquired. Best of all, SPA lets you make software performance bench- marks and predictions before any costly hardware is produced. SPA is closely coupled to the emulation/analysis environment by such features as cross-triggering and an enable/disable window. You can control when data is collected and filter out irrelevant activity.

Model 64310A software performance analyzer provides overview measurements to aid in evaluating total system effectiveness of programs operating in real time. Global measurements let software designers determine where resources are being used, in terms of



The HP 64310A software performance analyzer verifies and benchmarks both high-level and assembly-level code, even when they are mixed. With this analyzer, you can measure entire program activity (activity), locate the most active modules and determine if they are bind called too often (linkage), and measure how long any subroutine takes to execute (duration).

execution times, memory usage, and interaction traffic. Software performance measurements aid in determining where to focus optimization efforts for maximum effect on system performance.

- Histogram displays for quick comparisons of software activity
- Tabular displays with continually updated means and standard deviations on current measurement
- Measurement modes of memory and program activity
- Measurement modes of event duration
- Measurement modes of intermodule linkages

**Ordering information**

The HP 64000 AxCASE development environment is a dynamic family of software and hardware development tools for embedded micro- processor-based systems. With development support for over sixty 8-, 16-, and 32-bit microprocessors, there are many combinations of solutions available. Contact an HP sales representative for a suggested system configuration that will fit your application. For a copy of our latest brochure, in the U.S., call 1-800-447-3282; in Colorado, call 719-590-5540 (please call between 8:00 am and 5:00 pm mountain time). Outside the U.S., please call your local HP sales office.

Following are examples of bundled emulation systems hosted on the HP 9000 Series 375 workstation. The emulation subsystems range from 8- to 32-bits. The bundle, in these examples, includes a color monitor, 323 Mbyte disk, and software. If you do not need a bundled system, emulation subsystems and software are available separately.

Model	Description	Price
HP 64134S	with HP 9000 Series 375CH workstation, 323 Mbyte disk, HP 64120 card cage	\$53,960 to \$79,875
HP 64134S	with HP 9000 Series 375CH workstation, 323 Mbyte disk, and HP 64700 series emulator/analyzer with 512 k memory and 16-bit external state/timing analyzer	\$46,560 to \$66,090



### What is CASE?

The CASE acronym is most commonly interpreted as Computer Aided Software Engineering. "Software engineering" refers to a set of disciplined engineering processes used to improve the quality and productivity of software. "Computer aided" refers to the use of tools to facilitate the use of the engineering disciplines.

There are as many interpretations of CASE as there are acronyms. The conservative interpretation includes only structured analysis and design tools or front-end tools. Further expansion of the definition of CASE includes any computerized tool that automates an aspect of the software development process. The move to a systems perspective of CASE is driving the development of integrated tool sets that will offer tools for design, source code generation, documentation, compilation, and testing into a single seamless environment. In a seamless environment, the tools are able to communicate with each other in a way that is transparent to the user.

A fully integrated environment encompassing the entire software development life cycle is the goal and vision of CASE. It has yet to be realized. What is the current state of software development and how can the goal be reached?

### The Full CASE Environment

What is needed is a software development process that provides for a full CASE environment:

- Formulation and analysis of the problem to be solved.
- Automation of specification, design, implementation, testing, debugging and maintenance.
- Reuse of software to improve the resulting systems.
- Management of personnel and other resources used in all of these activities.

The goal of CASE is to provide better quality software with less effort. We can consolidate the list of potential benefits and objectives of CASE as follows:

- Develop systems which meet users needs.
- Improve the quality of existing systems.
- Provide proven, repeatable methodologies for software development.
- Speed up the software development process and reduce software costs through automation of tasks in the development process.
- Provide quantitative information about the software development process and about the progress in product development.

### Software Life Cycle Models and Methodologies

The most common models used to represent the software life cycle range from the traditional waterfall approach to the evolutionary or spiral approach offered by Barry Boehm, or the circular model preferred by James Martin. Regardless of the software life cycle model used in the development process, there are common activities that can be identified.

**Requirements definition** - understanding and representing user and system requirements.

**System analysis** - Specification of WHAT the system will do. The translation of requirements results in a precise external specification of the system.

**Design** - HOW the system will meet the requirements or solve the problem. Results in a reasonable design or internal specification to implement the system.

**Construction/coding** - implementing the design, largely coding and conducting unit tests on modules of code.

**Integration and testing** - linking the modules, determining if the design meets the requirements.

**Maintenance** - making necessary updates and improvements to the system as the requirements change over time. Ideally, the life cycle is repeated in this phase in order to avoid introducing new errors.

### Key Components of the Integrated Environment

The following key components deserve special attention due to their importance for attaining a "true" software development environment. These activities are present in every phase of software development regardless of the life cycle model or the methodologies used.

**Configuration management** - coordinating software development to minimize the inevitable confusion involved with a team project. It is identifying, organizing, and controlling modification to the software being built by a programming team. The goal is to maximize productivity by minimizing mistakes.

**Project management** - the effective use of the resources necessary to complete the project. This includes planning, budgeting, staffing, estimating, and tracking.

**Documentation** - the production of documents required throughout the systems life cycle related to the overall project management standards.

### Setting Expectations

CASE is still evolving and moving towards a fully integrated environment. The focus needs to be on developing the underlying process and the enabling environment if CASE is to realize its full potential. But some of the components are available today to organizations who want to prepare themselves to take advantage of a totally integrated CASE environment. While examining their software development process and defining appropriate life cycle models, companies can bring in point tools that are presently on the market. Many experts think it unadvisable to change the existing development process all at once. Currently organizations can formulate a plan to evolve their processes, as a standard software development environment becomes a reality.

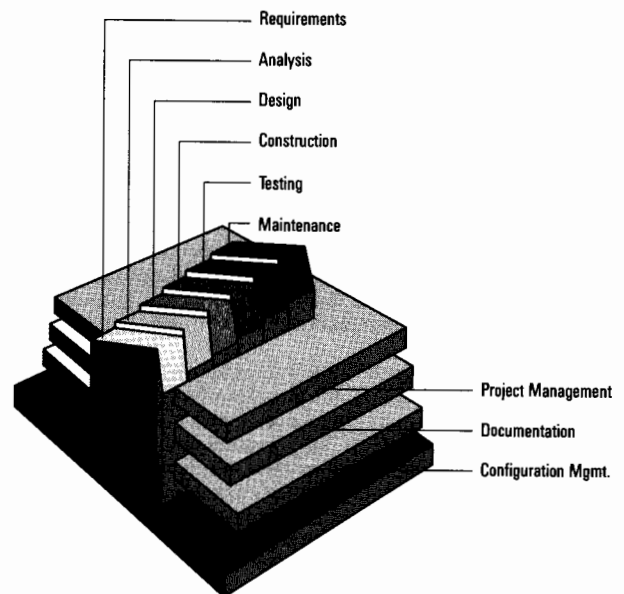

The Full CASE Environment

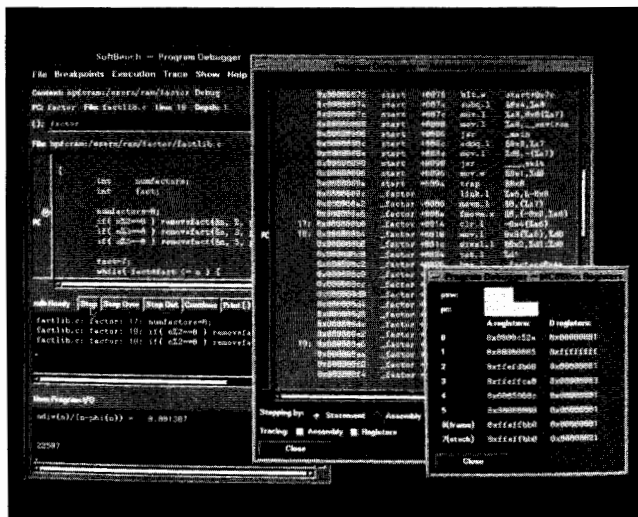

HP SoftBench - Debugger Screen

### HP CASEdge

HP CASEdge is the program name for HP's Computer Aided Software Engineering (CASE) products. There are three categories of products that are part of this family:

- HP CASEdge/Environments - Integration platforms which can be populated and customized to meet the different needs of software developers.
- HP CASEdge/Tools - CASE tools which satisfy needs in each of the areas of the software lifecycle.
- HP CASEdge/Knowledge - Software engineering consulting services covering: assessment, metrics, education, methods and implementation assistance, which are designed to help software organizations improve their development and management processes.



### HP SoftBench for HP-UX and Domain/OS

HP SoftBench is an extensible software development environment consisting of both an integrated set of program development tools and a Tool Integration Platform. Program development in C, FORTRAN and Pascal is supported. HP SoftBench provides tools which target the program construction, test and maintenance phases of software development.

HP SoftBench provides an easy-to-use development environment that leverages the power of UNIX® and the industry-standard X Window System, Version 11®. Programmers new to UNIX will find a friendly, easy-to-use environment. Experienced UNIX programmers can take advantage of the Tool Integration Platform of HP SoftBench to extend and customize their own environment. With HP Encapsulator you can extend the HP SoftBench environment by adding your tools of choice to the Tool Integration Platform, and you can customize the environment by automating development processes of choice.

UNIX is a registered trademark of AT&T in the USA and other countries. X Window System is a trademark of Massachusetts Institute of Technology. OSF/Motif is a trademark of the Open Software Foundation.

### Integrated Program Development Tools

**Program Editor:** The Program Editor is an easy-to-learn, language-sensitive, mouse/menu-based source file editor designed to minimize syntax errors. The following features are supported:

- Synchronized file views
- Querying
- Customizability
- Alternate editor support

**Program Builder:** The Program Builder, based on the utilities *make* and *mkmf*, automates the process of compiling a program composed of many different source files. The following features are supported:

- Efficient builds
- Error browsing
- Remote builds

**Program Debugger:** The Program Debugger, based on *xdb* on HP-UX or DDE on Domain/OS, is a multiwindow debugger which is designed to enhance the understanding of the dynamic execution of programs. The following features are supported:

- Multiview interface
- Parent/child tracing (available on Domain/OS only)
- Breakpoints
- Program tracing
- Register tracing
- Querying
- Record/playback (available on HP-UX only)

**Static Analyzer:** The Static Analyzer provides information regarding the structure of a program. It provides cross-reference queries, function queries, and does general pattern matching. The Static Analyzer's features make it a particularly valuable tool while maintaining or porting code. The following features are supported:

- Browsing
- Recompiling
- Scoping
- Query history

(Note: The Static Analyzer is not supported for FORTRAN or Pascal on the Series 300, or the Domain Series.)

**Development Manager:** The Development Manager makes code management an integral part of the development process in HP SoftBench. The Development Manager provides browsing and point-and-click access to the files related to a software project. Other tools can then be invoked to operate on files that have been selected. The following features are supported:

- Version management choice
- Version control
- Access from other tools
- Extensibility and configurability

**Mail:** HP SoftBench Mail is an encapsulation of the HP-UX *mailx* program. *Mailx* is an interactive message processing system, used to read, send, edit, and manipulate mail.

### Tool Integration Platform

The Tool Integration Platform is a framework that provides tool communication, distributed computing support, a common user interface, and an integrated help facility. The Tool Integration Platform provides an architecture designed to support a powerful new generation of software tools which are highly interactive, task-oriented, interchangeable, yet tightly integrated.

# DESIGN AUTOMATION

## SW DesignCenter (Cont'd)

### HP CASEdge

**Tool communication** - The HP SoftBench tools communicate in a networked, heterogeneous environment via a broadcast communication facility designed to support close communication of independent tools. Tools provide compatible user and programmatic access to functionality; anything accessible from the user interface is accessible programmatically. Message requests allow one tool to invoke the functionality of another tool, and notification messages allow tools (or the user) to define triggers which respond to events and initiate other actions.

Tool communication allows users to customize and extend the HP SoftBench environment. Users may bring their own tools into the HP SoftBench programming environment by using HP Encapsulator. One or more tools may be linked together to support a task or process. Tool encapsulation is a means to provide the Tool Integration Platform's features to standard UNIX command-line oriented tools, without modifying source code.

**Distributed computing services** - The HP SoftBench environment supports distributed execution, distributed data, and distributed display.

**Distributed execution:** The HP SoftBench tools can execute on any host in the network, provided that the host has HP SoftBench installed.

**Distributed data:** With HP SoftBench, data can reside on any host in the network.

**Distributed display:** Distributed display allows access to HP SoftBench from anywhere on the network, including non-HP computers.

**User interface** - HP SoftBench provides a multi-window graphical user interface. Productivity is increased by having a consistent user interface across all tools. HP SoftBench implements the OSF/Motif appearance and behavior adopted by OSF as an industry standard.

**Integrated help facility** - Help can be obtained for general information, context-sensitive information, and definitions of terms used by any of the HP SoftBench tools.

**Industry standards** - HP SoftBench is based on industry standards



### HP Encapsulator for HP-UX and Domain/OS

HP Encapsulator allows users to extend and customize the HP SoftBench development environment. The HP SoftBench environment can be extended by using HP Encapsulator to add user-developed, third-party, and existing UNIX tools, without source code modification. It can be customized by using HP Encapsulator to automate development processes by establishing communication links between HP SoftBench tools and user-added tools. The result of this encapsulation process for the new tool is a consistent user interface based on the OSF/Motif appearance and behavior, and the ability for that tool to communicate with the other HP SoftBench tools.

Tool encapsulation is a means to enable tools that were developed in the standard UNIX pipe model and are nonscreen oriented, to use the Tool Integration Platform features in HP SoftBench.

### Configuration Information

Components	Series 300	Series 800	Domain Series
System Software	HP-UX Prog. Environment 7.0	HP-UX Prog. Environment 7.0	Domain/OS 10.2 update 1
	X Window Sys., Version 11	X Window Sys., Version 11	X Window Sys., Version 11
System Models	340 and above	825 and above	DN2500, DN3500, DN4500, DN10000
Physical Memory	Min. 12 MB RAM*	Min. 16 MB RAM	Min. 12 MB RAM* 16MB RAM DN10000
Display	High-resolution (1024 x 768 min.) bit-mapped display (typical)	High-resolution (1024 x 768 min.) bit-mapped display (typical)	High-resolution (1024 x 768 min.) bit-mapped display (typical)
Input Devices	Keyboard/Mouse	Keyboard/Mouse	Keyboard/Mouse
Disk	307 MB (typical)	571 MB (typical)	350 MB - DN2500, DN3500, DN4500 700 MB - DN10000

\*An 8 MB system can be configured if several of the HP SoftBench tools are configured to run remotely.

### Ordering Information

HP SoftBench must be purchased for each workstation that will be used to run one or more of its programming tools. If it is desired to customize HP SoftBench by adding additional tools or by automating development processes, then both HP SoftBench and HP Encapsulator must be purchased. HP Encapsulator is only required for development. Runtime support is provided by HP SoftBench.

Product	Product Number
<b>HP 9000</b>	
<b>Series 300</b>	
HP SoftBench License-to-Use	B1621A
HP Encapsulator License-to-Use	B1625A
HP SoftBench Media and Manuals	B1622A
HP Encapsulator Media and Manuals	B1626A
<b>Series 800</b>	
HP SoftBench License-to-Use	B1623A
HP Encapsulator License-to-Use	B1627A
HP SoftBench Media and Manuals	B1624A
HP Encapsulator Media and Manuals	B1628A
<b>Domain Series</b>	
<b>DN2500, DN3500, DN4500</b>	
HP SoftBench License-to-Use	B1851A
HP Encapsulator License-to-Use	B1855A
HP SoftBench Media and Manuals	B1852A
HP Encapsulator Media and Manuals	B1856A
<b>DN10000</b>	
HP SoftBench License-to-Use	B1853A
HP Encapsulator License-to-Use	B1857A
HP SoftBench Media and Manuals	B1854A
HP Encapsulator Media and Manuals	B1858A



## HP Electronic Design System

The HP Electronic Design System includes the following: HP Design Capture System, HP Design Verification System with System HILO™, Parts Libraries, Design Interfaces to physical layout systems, and links to the HP Programmable Logic Device Design System and to prototype and manufacturing test systems. This integrated set of tools addresses the total electronic product development process.

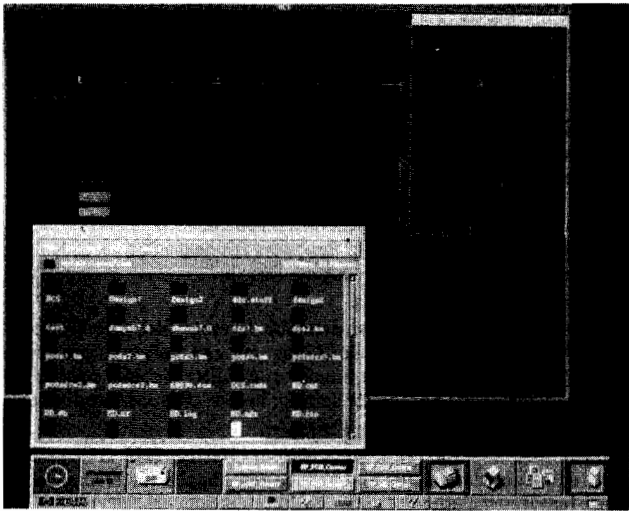

### Design Capture System

The HP Design Capture System is the cornerstone of HP's Electronic Design System, providing schematic capture and design database management capabilities to improve the electronic design process. It forms the database and user interface foundation upon which other elements of the HP Electronic Design System are built. Engineers can use this same intuitive user interface to access a variety of tools for entering and editing schematics for digital, analog, and microwave circuits.

The HP Design Capture System also provides on-line checking of design parameters such as fan-out, incompatible outputs, unused pins, unconnected wires, wire loops, and symbol pin mismatch. Finding design errors as soon as they are entered helps avoid costly rework at later stages of the design cycle. Additional features designed to enhance productivity include automatic orthogonal routing of signals and the use of color to help organize complex circuits by highlighting different signal types or different areas of functionality on a circuit.

With full support for top-down, bottom-up, or flat circuit design, the HP Design Capture System provides the flexibility for you to work the way you want. For top-down design, you can create symbols "on the fly" without leaving the circuit page on which you are working. An automatic symbol-creation facility speeds the process of bottom-up design. Flat designs spread over several pages become easier to handle with automatic part or signal locating functions.

Regardless of the design methodology you choose, the advanced database structure provides access to other design information such as physical references. This access makes interfaces with physical layout systems faster, more complete, and reliable. It also makes comparison of simulation data with a prototype or production device quick and easy.

### Comprehensive Parts Libraries

Extensive, ANSI-compatible parts libraries support a wide variety of digital and analog design requirements. These libraries contain both symbolic and parametric information for more than 5,500 digital and 3,700 analog parts, including off-the-shelf TTL, ECL, MOS, microprocessor, and passive and active analog devices. In addition to providing a graphical symbol for schematic drawing, each part entry contains information used in other functions of electronic design, including titles and revision levels, load information, scions or related parts, and physical design information.

The object-oriented structure of the HP Design Capture System database simplifies access and increases the speed at which information can be found, extracted, updated, or created. With an object-oriented structure, the wires, components, pins, symbols, and other elements used in electrical design are not merely graphics inside the database but "objects" containing all the connective or textual information to define a wire, component, pin, or symbol.

### Design Verification System

HP's Design Verification System, based on industry-proven System HILO simulation products, provides logic simulation, extensive model libraries and fault simulation.

By using the intelligent database, connectivity information of the complete circuit is maintained at all times. Because this electrical circuit representation is available on line, it is easy to move back and forth between design and simulation when making circuit modifications.

The flexible simulator interface provides a choice of waveform or textual formats for input specification and output display. A Simulation Data File Comparator can be used to compare any two user-created or simulated trace files, or to compare measured files from the HP 16500A logic analyzer. The logic simulator incorporates a five-state, fifteen-value logic strength algorithm to accurately model MOS bidirectional gates, wired ANDs, wired ORs, or tristate pullups and pulldowns.

Simulation models are mapped one-to-one with the symbols in the HP Design Capture System parts libraries, which provide the graphic and parametric information for the design. This close coupling of the graphics and the simulation models provides complete and consistent access to commercially available parts throughout the logic design cycle, including TTL, ECL, and MOS parts as well as many complex microprocessors such as the Intel 8086 or the Motorola 68000. In addition, ASIC design kits containing programs, symbols, and models are available for specific ASIC vendors such as Fujitsu, Hitachi, LSI Logic, Matsushita, Mitsubishi Electronics, National Semiconductor, NEC, Toshiba, and others.

### Flexible Constructs for Functional Modeling

System HILO's modeling provides flexible, functional modeling constructs such as event expressions, register transfer functions, Boolean and arithmetic operators, loop constructs, and conditionals. Since the modeling language is an event-driven, nonprocedural language, asynchronous signals such as interrupts can be modeled exactly as they occur in hardware. Multilevel support in System HILO allows simulation of designs, even when some parts are specified at a functional level only.

### Links to Physical Layout

Design interfaces link the HP Electronic Design System with the Racal-Redac RINF, printed-circuit CAD system. Interface capabilities between the HP Design Capture System and the HP Printed Circuit Design System are built into both systems. This combination provides automatic transfer of design information, including back annotation or the initiation of engineering change orders. The HP Design Capture System also includes an interface to the HP Engineering Graphics System (see page 659) as a standard feature.

### Configuration

The HP Design Capture System is available on the HP 9000 Series 300 and HP Apollo 9000 Series 400.

### Ordering Information

HP 74210A HP Design Capture System  
 HP 74230S HP Design Verification Sub-System  
 HP 74230A HP Design Verification Interface  
 (includes HP Software Link)  
 HP 74230B System HILO Logic Simulator  
 HP 74236 System HILO Simulation Models  
 HP 74230D System HILO Fault Simulator  
 HP 74240B Simulation Data File Comparator  
 System HILO and HICHP are registered trademarks of GenRad.

# DESIGN AUTOMATION

## EE DesignCenter

### HP Printed Circuit Design System

#### HP Printed Circuit Design System

- Definable technology files, tidy functions
- Customizable outputs to manufacturing, text
- Tailored for surface mount design, packaging
- Fast, interactive graphics
- Autorouter features
- Integration to HP Design Capture System
- Integration to 2D, 3D CAD

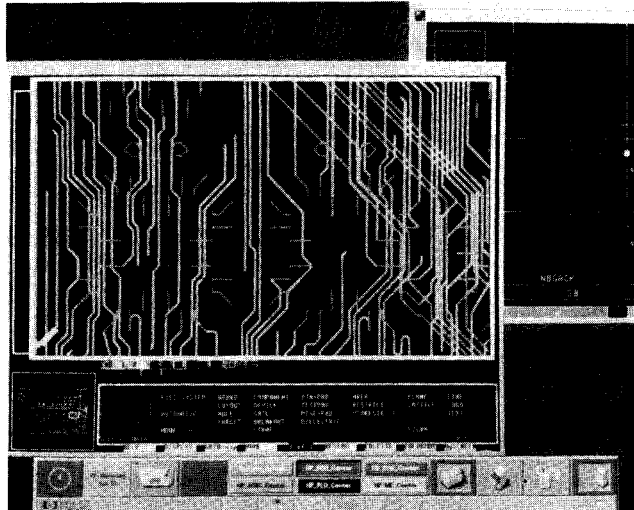

#### HP Printed Circuit Design System

The Hewlett-Packard Printed Circuit Design System (HP PCDS) is a computer-aided design (CAD) solution that combines printed circuit board layout with electrical engineering design, manufacturing, and test. HP PCDS is a part of HP DesignCenter, an integrated design environment for electrical, mechanical, and software engineering teams.

#### Design for Manufacturability

With the HP Printed Circuit Design System you can deliver highly manufacturable boards that comply to multiple manufacturing constraints, in record time. Manufacturability features include user-definable technology files, tidy functions, and customizable outputs to manufacturing and test.

#### User-definable technology files

User-definable technology files allow instant verification that the board meets the manufacturing requirements that you define. Many standard technology files are available or you can modify/create your own to meet your needs.

Some of the technology file data available for customization includes:

- pin, placement, and routing grids
- default spacing
- trace sizes
- device orientation
- pad and pad stack definitions
- definable pin-pad approach

#### Tidy functions improve board fabrication

Tidy functions such as these automatically improve the board for fabrication:

- eliminate unnecessary vias
- remove unnecessary routing or open ends
- add teardropping
- thickening, widening, or final adjustments to traces

#### Features Aid Transfer to Manufacturing

The HP Printed Circuit Design System includes functionality specifically to aid in transfer to manufacturing:

- user-customizable manufacturing outputs for flexibility in using manufacturing machines
- custom reports
- HP board test outputs
- photoplotter mask output
- links to manufacturing, test (HP 3065/3070 Board test)

The design file format is open and completely documented, so users can also customize ways to input or output data. Access routines are provided. Because the design file contains all of the data for a particular design, redundant data entry is eliminated and chances for errors are reduced.

#### Tailored for Surface Mount Design, Packaging

Leading-edge router technologies included with the HP Printed Circuit Design System include:

- User-specified tracking, via grids for number of traces between IC legs and SMD pads
- SMDs with hidden or buried vias
- User-defined angle and length of approach to SMD pads (Definable pin-pad approach helps route dense SM designs)

#### Fast, Interactive Design and Graphics

The interactive graphics of the HP Printed Circuit Design System enhance your productivity. Pan and zoom features allow the system to keep up with your ideas.

- Area copy and rotate of traces and vias to reduce layout time
- Multilevel UNDO allows users quick recovery
- Highlighted guideline to help designers connect nets
- Automatic display of circuit copper length

#### Autorouter Strategy Files

The autorouter includes user-definable strategy files which help ensure 100% routes. Some of the things you can define to maximize automatic routing for the best manufacturability include: costs; right way/wrong way; via parameter setting; layers; diagonal, and more.

#### Integration to Schematic Capture

Tight links with the HP Design Capture System (HP DCS) eliminate redundant data entry and reduce the chance for errors. Additional features include:

- transfer of netlist, parts information at the push of a button
- back annotation, two-way ECOs
- components for all your mainstream needs, easy-to-use symbol editor to cover custom parts

HP PCDS can also accept netlist data from products that support the Electronic Design Interchange Format (EDIF), such as OrCAD, P-CAD, and ViewLogic. With the EDIF link, engineers can develop schematics on HP Vectra personal computers and then transfer the netlist for layout and routing to the high performance workstation and HP PCDS.

#### Integration to 2D and 3D CAD

The integration of the HP Printed Circuit Design System to industry-leading 2D and 3D CAD tools (such as HP ME10) allows concurrent design between layout and mechanical.

- Defines starting point of PCB layout by transferring information such as board outline, mounting holes, via restricts
- Release drawings utilize ME10 to annotate, add dimensioning, provide isometric views
- 3D allows finite element analysis, 3D fit analysis

#### Flexible Data Management

The HP Design Data Controller provides flexible data management and file security for users of HP Electronic Design System and Printed Circuit Design System. Large design teams can control data revisions, and file access, and also lock data at project checkpoints to prevent unauthorized or unsynchronized updates.

#### Configuration

The HP Printed Circuit Design System is available on the HP 9000 Series 300 and HP Apollo 9000 Series 400.

#### Ordering Information

HP Printed Circuit Design System

**74400A** HP Printed Circuit Design System, complete software includes: the Design Module, Autorouter Module, and the Library Module

**74400R** Right-to-Copy complete software

**74401A** HP Printed Circuit Design System, Design Module

**74401R** Right-to-Copy Design Module

**74402A** HP Printed Circuit Design System, Autorouter Module

**74402R** Right-to-Copy Autorouter Module

**74403A** HP Printed Circuit Design System, Library Module

**74403R** Right-to-Copy Library Module

**74420A** HP Design Data Controller (HP DDC)

#### HP PLD Design System

- Easy PLD design
- Device independent
- Automatic fit, partitioning
- Integration with HP Electronic Design System

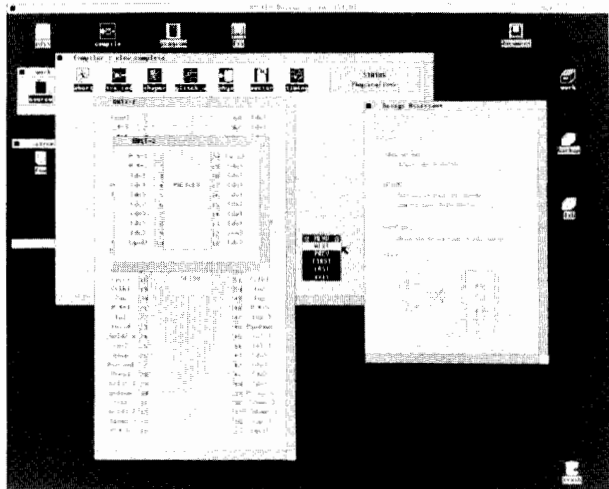

The HP Programmable Logic Device (PLD) Design System is an easy-to-use productivity tool that automates the design, verification and implementation of PLDs. It provides a device-independent design environment that allows engineers who rarely design PLDs to do so with minimal effort.

#### Automatic Fit, Partitioning

Designers can develop and verify logic without the constraints of a particular PLD architecture. The system automatically fits complex designs into the most efficient PLD, and if necessary, partitions designs into multiple devices. It also provides insight to this process, allowing designers to understand the automatic choices made. HP PLD Design System supports the entire design process of PLDs—from conceptual and functional design, through automatic device selection and pin/resource assignment, to debugging and fusemap generation.

#### Integration to HP Electronic Design System

HP PLDDS is tightly linked with the HP Electronic Design System (see page 657) to allow transfer of designs or parts of designs for PLD realization. After device selection, the information can be transferred back to the HP Electronic Design System for design layout and documentation.

#### PLD Design Entry and Verification

Without considering the target device, engineers enter designs with schematic symbols, graphical state diagrams, truth tables, waveforms, or Boolean equations. HP PLD Design Center debuggers specific to each design entry method are tightly integrated to quickly verify PLD designs at the same level of abstraction.

#### Waveform Entry

In the design of asynchronous circuits, a timing diagram often exists showing the desired functionality in terms of certain input activity causing output activity. HP PLD Design System automatically creates the necessary logic from this timing diagram.

#### Device Independence

HP PLD Design System automatically selects the most appropriate PLD—or multiple PLDs—from a prioritized list of the most efficient devices for the design. You can also modify the system's choice of devices.

#### Programming and Test Generation

For device programming, the HP PLD Design System transfers fusemap information in JEDEC standard format directly to a variety of PLD programmers, eliminating the need for programmer commands. The system automatically creates electrical test patterns to evaluate the behavior of programmed devices before designs are released to production.

#### Ordering Information

##### HP B1867A HP PLD Design System

HP Programmable Logic Device Design System (PLDDS)—Editors, EDS link, utilities, foreign tool interface, programmer, simulator, design analyzer, compiler

Contact your local Hewlett-Packard sales office for current prices and ordering information (see page 737 for sales offices).

#### The HP Engineering Graphics System

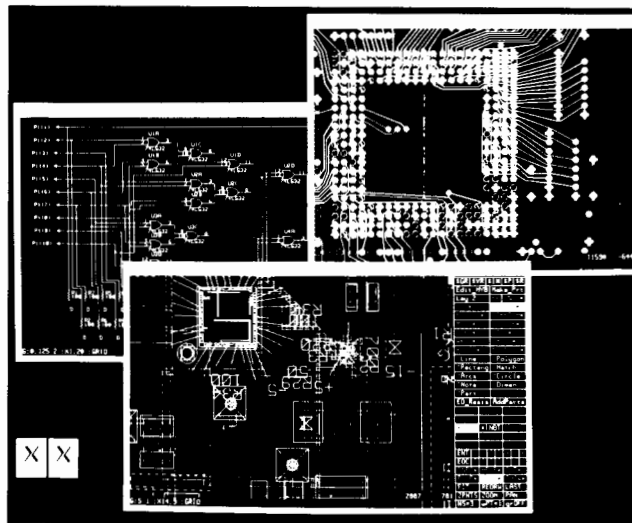

HP offers a two-dimensional, highly customizable, artwork-based family of entry-level, computer-aided design (CAD) modules for complete product design in electronic, mechanical, and general engineering applications. The HP Engineering Graphics System (HP EGS) consists of several modules allowing creation of schematic drawings; interactive PCB layout; thick-film hybrid circuit design; and general artwork.

HP EGS is available on the HP-UX operating system, X Windows and Pascal operating system. The HP-UX operating system offers a true multitasking environment that allows interactivity with many design applications. HP EGS can be used as a stand-alone system or in a networked diskless environment.

The modular product structure of HP EGS lets designers use workstations as multipurpose design systems to provide several applications for a project. Because all modules share a common data structure and user interface, they are automatically linked. Links include those to: HP Printed Circuit Design System and HP ME10 as well as IGES and EDIF links.

Contact your local Hewlett-Packard sales office for current prices and ordering information (see page 737 for sales offices).

# Electronic Design Automation Solutions

HP offers the broadest choice of solutions on the broadest range of workstations in the EDA market. Choices that include the leading products and top performers for EDA solutions, from single-vendor, broad line solutions to niche applications.

## System-Level Design

### Conceptual Design

CAD Language Systems, Inc.  
Cadence Design Systems, Inc.  
Mentor Graphics Corp.  
Racal-Redac, Inc.  
Silvar-Lisco  
Synopsys, Inc.  
Teradyne, Inc.  
Vantage Analysis Systems, Inc.  
Zycad, Inc.

### Design Analysis

Analogy, Inc.  
Cadence Design Systems, Inc.  
Compact Software, Inc.  
GENRAD, Inc.  
IKOS Systems, Inc.  
Manitoba HVDC Research Centre  
Mentor Graphics Corp.  
Racal-Redac, Inc.  
Teradyne, Inc.  
Vantage Analysis Systems, Inc.  
Zuken

### Physical Design & Analysis

Engineering Mechanics Research  
Mentor Graphics Corp.

**Info. Mgmt.**  
Automated Images, Inc.  
EDA Systems  
Expert Views  
Frame Technologies  
Interleaf  
Mentor Graphics Corp.  
Sherpa  
Systems Effectiveness Associates, Inc.

## Board-Level Design

### Conceptual Design

CAD Language Systems, Inc.  
Cadence Design Systems (ASI)  
Cadence Design Systems, Inc.  
Comdisco Systems, Inc.  
DSP Development  
Entropic Speech, Inc.  
Expert Software Systems  
Hewlett-Packard, Co.  
Mentor Graphics Corp.  
Racal-Redac, Inc.  
Silvar-Lisco  
Synopsys, Inc.  
Teradyne, Inc.  
Test Quality Co.  
Vantage Analysis Systems, Inc.  
Zycad, Inc.

### Design Analysis

AB Associates  
AEG-Telefunken  
Software-Technik  
Analogy, Inc.  
APSI  
CAD Group, Inc.  
Cadence Design Systems (ASI)  
Cadence Design Systems, Inc.  
Comdisco Systems, Inc.  
Compact Software, Inc.  
Control Data GMBH  
DSP Development  
EESof, Inc.  
Electrical Engineering Software  
Electrocon International, Inc.  
Entropic Speech, Inc.  
EPIC Design  
Technology, Inc.  
Expert Software Systems  
GENRAD, Inc.  
Hewlett-Packard, Co.  
IKOS Systems, Inc.  
Image Acoustics, Inc.  
ISDATA

Logic Automation, Inc.  
Mentor Graphics Corp.  
Meta-Software, Inc.  
Microsim Corp.  
NCR Microelectronics  
Quad Design  
Technology  
Quadtree  
Racal-Redac, Inc.  
Silvaco Data Systems  
Source III, Inc.  
Systems Effectiveness Associates, Inc.  
Tatum Labs, Inc.  
Teradyne, Inc.  
Test Quality Co.  
Texas Instruments Ltd.  
Thomson Informatique Services  
University of California, Berkeley  
Valid Logic Systems  
Vantage Analysis Systems, Inc.  
Zuken  
Zycad, Inc.

## Physical Design & Analysis

Cadence Design Systems (ASI)  
CADISYS Corp.  
CADIX Inc.  
CAD-UL GMBH  
DECAD S.A.  
Electrical Engineering Software  
Electrocon International, Inc.  
Engineering Mechanics Research  
Hewlett-Packard, Co.  
Hytech Consultants Ltd.  
Infinite Graphics  
Magsoft  
Mentor Graphics Corp.  
Pacific Numerix Corp.  
Quantic Laboratories, Inc.  
Racal-Redac, Inc.  
Secmai S.A.  
Shared Resources, Inc.  
Silvar-Lisco  
Sonnelt Software, Inc.  
SwiftLogic Limited  
Tangram Computer Aided Engineering  
Task Technologies, Inc.  
Zuken

## Board-Level Design

### Mfg. & Test

AEHR Test Systems Corp.  
Cadence Design Systems (ASI)  
DSP Development  
Hewlett-Packard, Co.  
Mentor Graphics Corp.  
Simulst, Inc.  
SIS Microelectronics, Inc.  
Test Systems Strategies, Inc.  
**Info. Mgmt.**  
Automated Images, Inc.  
Cadence Design Systems (ASI)  
EDA Systems  
Expert Views  
Hewlett-Packard, Co.  
Mentor Graphics Corp.  
SIS Microelectronics, Inc.

## ASIC Design - PLD&FPGA

**Conceptual Design**  
Beijing Institute of Technology  
CAD Language Systems, Inc.  
Data I/O Corp.  
Hewlett-Packard, Co.  
Logical Devices, Inc.  
Mentor Graphics Corp.  
NCR Microelectronics  
Racal-Redac, Inc.  
Synopsys, Inc.  
VLSI Technology, Inc.  
**Design Analysis**  
Beijing Institute of Technology  
Cadence Design Systems, Inc.  
Data I/O Corp.  
Hewlett-Packard, Co.  
Logical Devices, Inc.  
Mentor Graphics Corp.  
NCR Microelectronics  
Racal-Redac, Inc.  
VLSI Technology, Inc.

## ASIC Design - PLD&FPGA Physical Design & Analysis

Cadence Design Systems, Inc.  
Hewlett-Packard, Co.  
Mentor Graphics Corp.  
Racal-Redac, Inc.  
VLSI Technology, Inc.  
**Mfg. & Test**  
Compass Development  
Hewlett-Packard, Co.  
Racal-Redac, Inc.  
Test Systems Strategies, Inc.  
**Info. Mgmt.**  
Cadence Design Systems, Inc.  
Hewlett-Packard, Co.  
Mentor Graphics Corp.  
Racal-Redac, Inc.

## ASIC Design - Advanced Conceptual Design

Cadence Design Systems, Inc.  
CAD Language Systems, Inc.  
Expert Software Systems  
Hewlett-Packard, Co.  
Integrated CMOS Systems  
Mentor Graphics Corp.  
NCR Microelectronics  
Praxis Systems PLC  
Racal-Redac, Inc.  
Seattle Silicon Corp.  
Silvar-Lisco  
Synopsys, Inc.  
United Silicon Structures, Inc.  
Vantage Analysis Systems, Inc.  
VLSI Technology, Inc.  
Zycad, Inc.

### Design Analysis

Cadence Design Systems, Inc.  
CARO-LINE Habigand  
EPIC Design  
Expert Software Systems  
GENRAD, Inc.  
Hewlett-Packard, Co.  
Hitachi Ltd.  
IKOS Systems, Inc.  
Integrated CMOS Systems  
KAIDE CAD Development & Application Co.  
LSI Logic Corp.  
Mentor Graphics Corp.  
NCR Microelectronics  
Performance CAD  
Praxis Systems PLC  
Quad Design  
Technology, Inc.  
Qudos, Ltd.  
Racal-Redac, Inc.  
Seattle Silicon Corp.  
Sierra Semiconductor Corp.  
Source III, Inc.  
Tool Corporation  
United Silicon Structures, Inc.  
University of California, Berkeley  
Vantage Analysis Systems, Inc.  
VLSI Technology, Inc.  
Zycad, Inc.

## ASIC Design - Advanced Physical Design & Analysis

Cadence Design Systems, Inc.  
Integrated CMOS Systems  
KAIDE CAD Development & Application Co.  
LSI Logic Corp.  
Mentor Graphics Corp.  
NCR Microelectronics  
Qudos, Ltd.  
Racal-Redac, Inc.  
Seattle Silicon Corp.  
Silvar-Lisco  
United Silicon Structures, Inc.  
VLSI Technology, Inc.

### Mfg. & Test

Compass Development  
Hewlett-Packard, Co.  
Integrated Measurement Systems, Inc.  
Racal-Redac, Inc.  
Simulst, Inc.  
SIS Microelectronics, Inc.  
Test Systems Strategies, Inc.  
**Info. Mgmt.**  
Cadence Design Systems, Inc.  
Hewlett-Packard, Co.  
Mentor Graphics Corp.  
Racal-Redac, Inc.  
SIS Microelectronics, Inc.

## IC Design - Full Custom Conceptual Design

CAD Language Systems, Inc.  
Cadence Design Systems, Inc.  
Expert Software Systems  
Mentor Graphics Corp.  
Silvar-Lisco  
Synopsys, Inc.  
Vantage Analysis Systems, Inc.  
VLSI Technology, Inc.  
Zycad, Inc.

### Design Analysis

Cadence Design Systems, Inc.  
CARO-LINE Habigand  
EPIC Design  
Technology, Inc.  
Expert Software Systems  
GENRAD, Inc.  
IKOS Systems, Inc.  
KAIDE CAD Development & Application Co.  
Mentor Graphics Corp.  
LTX Corporation  
Quad Design  
Technology, Inc.  
Racal-Redac, Inc.  
Source III, Inc.  
Tool Corporation  
University of California, Berkeley  
Vantage Analysis Systems, Inc.  
VLSI Technology, Inc.  
Zycad, Inc.

## IC Design - Full Custom Physical Design & Analysis

Cadence Design Systems, Inc.  
Integrated Silicon Systems, Inc.  
KAIDE CAD Development & Application Co.  
Kollmorgen Corp.  
Mentor Graphics Corp.  
NCR Microelectronics  
Pacific Numerix Corp.  
Racal-Redac, Inc.  
Sandhill Systems  
Silvaco Data Systems  
Silvar-Lisco  
Technology Modeling Associates, Inc.  
Tool Corporation  
University of California, Berkeley  
VLSI Technology, Inc.

### Mfg. & Test

Compass Development  
Integrated Measurement Systems, Inc.  
Mentor Graphics Corp.  
Simulst, Inc.  
SIS Microelectronics, Inc.  
Test Systems Strategies, Inc.  
**Info. Mgmt.**  
Cadence Design Systems, Inc.  
Mentor Graphics Corp.  
SIS Microelectronics, Inc.

## IC Design - Hybrid Conceptual Design

Hewlett-Packard, Co.  
Mentor Graphics Corp.  
Racal-Redac, Inc.  
Zuken

### Design Analysis

CARO-LINE Habigand  
Compact Software, Inc.  
EESof, Inc.  
Electrical Engineering Software  
Hewlett-Packard, Co.  
Mentor Graphics Corp.  
Racal-Redac, Inc.  
Zuken

### Physical Design & Analysis

Compact Software, Inc.  
EESof, Inc.  
Electrical Engineering Software  
Hewlett-Packard, Co.  
Mentor Graphics Corp.  
Pacific Numerix Corp.  
Racal-Redac, Inc.  
Zuken

### Mfg. & Test

Hewlett-Packard, Co.  
Mentor Graphics Corp.  
Racal-Redac, Inc.  
Zuken  
**Info. Mgmt.**  
Mentor Graphics Corp.

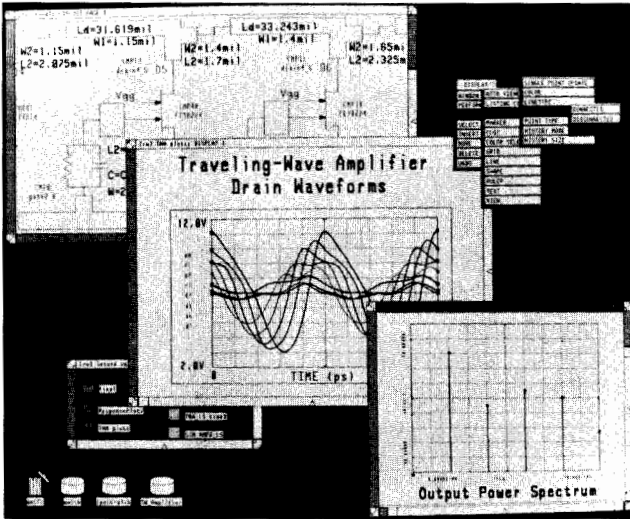

The HP 85150B microwave-design system integrates schematic capture, simulation, artwork generation, and documentation to speed the high-frequency design process.

### HP 85150B Microwave Design System

- Available on HP, Apollo, Sun, and 386/486 workstations.
- Interact with schematic, simulation, artwork, and documentation simultaneously.
- Minimize prototyping with advanced linear and nonlinear simulators.
- Ease documentation chores with automatic links to schematics and simulation results.
- Generate artwork from the schematic automatically.

### Integrated Solution for High Frequency Design

The HP 85150B microwave design system is an integrated CAE package for microwave and RF engineers. It provides extensive modeling, analysis, and layout capabilities to take a design from its conception to physical representation. It is particularly well-suited for developing monolithic microwave integrated circuits (MMICs), as well as hybrid microwave and RF circuits.

The HP microwave design system integrates the design capture system, the microwave linear simulator, the microwave nonlinear simulator, and the microwave artwork generator, with an exceptionally convenient documentation facility. Switching from one application to another is as easy as clicking a mouse button.

With the design capture system, you can enter circuit schematics as easily and intuitively as you would draw them on paper. These schematics are used by the microwave linear or nonlinear simulator for analysis, optimization, or manual tuning. When satisfied with the circuit performance, you invoke the microwave artwork generator to generate the mask layouts automatically.

The information you create with the microwave design system is easily consolidated for immediate documentation. Generate engineering notebooks, reports, proposals, and production forms with minimum overhead. By preserving and leveraging the knowledge of the R&D environment, you can design circuits of increasing complexity.

### Ordering Information

#### HP 85150B Microwave Design System

- The HP 85150B includes the following:
- Design-capture system
  - Microwave linear simulator
  - Microwave nonlinear simulator
  - Simulator interface
  - Microwave-artwork generator

**Price**  
\$44,500



The HP 85180A High-frequency Structure Simulator creates S-parameters and electromagnetic field plots for passive structures, such as machined components and circuit models.

### HP 85180A High-frequency Structure Simulator

- Available on HP, Apollo, and Sun workstations.
- Calculates S-parameters for multiport structures.
- Requires no knowledge of electromagnetic field theory
- Unrestricted geometries with unlimited number of dielectrics and conductors.
- Analysis is based solely on Maxwell's equations and includes dispersion.
- Complete solution for electric and magnetic fields, energy densities, and more.

### Electromagnetic Field Solutions for Non-Experts

The HP 85180A high-frequency structure simulator computes S-parameters for passive, three-dimensional structures. Although the simulator performs complete electromagnetic solutions, users need no background in electromagnetic field theory to operate it. It requires only geometric and material parameters.

The high-frequency structure simulator has many applications, including: microwave machined component design; microwave, RF, and high-speed digital circuit modeling; and production refinement. Machined component designers can simulate complex designs before investing in a custom-machined prototype. High-frequency circuit designers can create model libraries of transmission line structures and other circuit elements for use with their circuit simulators. Production engineers can use the high-frequency structure simulator to study the effect of tolerance variations on quality and manufacturing yield.

Links to other systems enhance design productivity. As part of the HP DesignSystem, the high-frequency structure simulator is more than a single-point solution. Mechanical descriptions of components can be transferred from HP DesignCenter ME Series 30 mechanical design software. S-parameters computed by the high-frequency structure simulator can be used in the HP microwave-design system or in other circuit simulators.

### Ordering Information

#### HP 85180A High-frequency Structure Simulator

- The HP 85180A includes the following:
- High-frequency structure simulator
  - Simulator interface

**Price**  
\$45,000

# DESIGN AUTOMATION

## ME DesignCenter

### HP ME Series 10 and 30

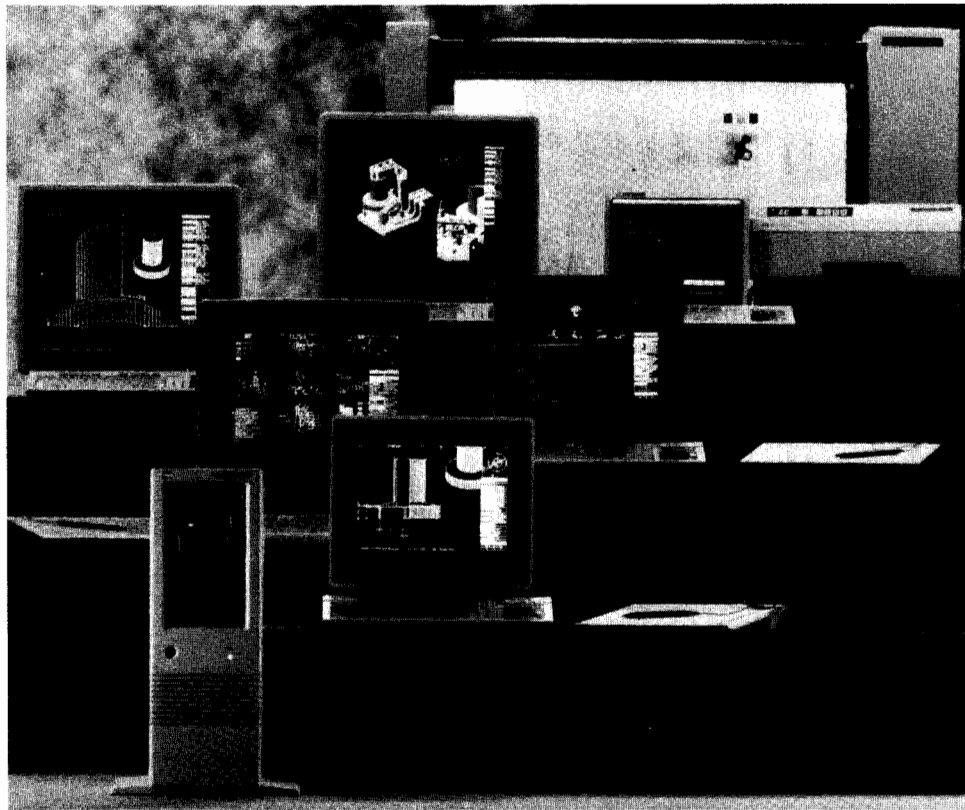

HP ME Series 10 and 30 offer advanced drafting, 2D design, and solids modeling systems for mechanical engineering applications. These CAD systems run on a distributed computing environment of HP workstations.

#### HP ME Series 10 & 30

HP ME Series 10 and 30 offer the full functionality required for drafting, documentation, 2D design and solid modeling. Both products use the same, easy-to-use user interface that drastically reduces the learning time to allow greater designer productivity. The systems operate on a complete range of hardware platforms and under the major industry standard operating systems.

#### Drafting and Documentation

The ME Series 10 provides comprehensive drafting functionality and extensive 2D design capabilities. It also provides a complete set of functions to accelerate the production of drawings and other engineering documentation, while ensuring a standard of accuracy.

#### Design

ME Series 10 offers users an advanced set of tools for 2D design. Powerful creation and modification commands, combined with interactive variational design for creation of families of parts, enhance the design process. An on-line design checking capability enables designers to quickly and easily develop accurate designs from a given set of constraints.

Major features of ME Series 10 include:

- Full dimensioning capabilities according to international standards (ANSI, ISO, DIN, etc.)
- Interactive and intuitive hidden line module
- Full text input and editing capability
- Comprehensive set of drafting symbols
- Semi-automatic isometric drawing creation
- Parts and assembly creation
- Unlimited number of layers available for drawing organization
- Parametric design capability
- Advanced geometry modification for adapting designs
- Associated information and attributes for material specifications and pricing details

#### Modeling

The ME Series 30 Modeling, Design, and Drafting system integrates full solid modeling with 2D design. Design accuracy within the 3D models provides the ability to simulate real prototypes. This substantially reduces the need for design modifications that result from errors in prototypes, thus allowing greater design department throughput.

Additional major features of ME Series 30 include:

- Workplane technique allows 3D model creation from 2D geometry
- Machining functions for model creation, including mill and stamp to support use of 2D geometry for model creation
- Photo-realistic imaging of models for perfect final documentation of designs
- Extensive design checking capability, including mass properties and interference
- Real-time manipulation of shaded 3D bodies for interactive assembly modeling capability

#### Data Management

Manage all design engineering information with HP's Product Information Management solution. Based on relational database technology, HP-DMS gives CAD users the tools needed to locate, retrieve, manage and control design office information - with the same, easy to use, ME CAD user interface.

The main areas where HP-DMS provides distinct productivity gains are:

- Product information management
- Management of the design process
- Network and security management

Product Information Management consists of day to day drawing and design administration including simple methods of storing and retrieving data. Drawing title blocks can be updated automatically by HP-DMS once a design is under its control. An interactive bill of materials processor can be called up at any time. Browsing and editing the information is easy before outputting to a file or drawing in a user specific format. The classification system aids designers in storing and finding standard parts and designs efficiently. HP-DMS provides all the query capabilities of a comprehensive DBMS system from within the ME CAD environment. Associated retrieval methods allow design files to be found quickly.

Managing the design process includes revision and version control in conjunction with release control. To ensure that design information is not lost inadvertently, access control allows such information to be read by some and changeable by others. These security measures are completely customizable to suit each and every environment. Checking information in and out of HP-DMS prevents concurrent changes to design files.

Network and security management cover such aspects as backup and archiving, overall data security, and network control. HP-DMS provides users with a simple view of network storage areas, relieving them of the need to learn complicated network protocols or long path names to access their files. Data is controlled by HP-DMS and can reside on central disks or be distributed across local disks.

The overall flexibility of HP-DMS means that it can be set up to conform to company specific methods of data management, and customized to maximize productivity.

### View-only Stations

View-only stations provide instant access to graphical and textual information on the shop floor and at the manager's desk. Timely and accurate information minimizes the risk of costly miscommunications.

### User Interface

The key to success with computer tools is complete functionality and convenient access to that functionality. Computer tools must present functionality in a form understandable to the user. Nowhere is this more important than in the design environment where years of experience have led to the development of well proven design techniques.

Short learning cycles and friendly system handling are essential for engineering productivity. The HP ME Series products are menu-driven and provide the ease of use beginners require. In addition, they provide customizing capabilities for special applications.

The ME Series 10 and 30 user interface was specifically designed to ease user interaction by emulating traditional design techniques. As a result, the combined tablet and screen menu interface provides easy access to commands that use standard mechanical engineering terminology - commands such as fillet and mill are easy to understand and use. Interaction is further simplified by grouping the commands into functional blocks and the use of descriptive prompts. An on-line HELP facility is included to provide detailed descriptions of commands whenever necessary.

In both products, the user interface is optimized for mechanical design:

- System functions are directly accessible from the graphics tablet, complemented by screen menu subfunctions
- Multi-viewport capability eases handling of large and complex models, designs, and drawings
- On-line HELP facility provides detailed explanation of the use of commands
- Feedback mechanisms such as rubber banding and dynamic component tracking aid creation and modification operations

### Integrating and Interfacing Your CAD System

The CAD system is an important place of your total computer integrated manufacturing concept. It is the foundation for product development that allows a range of capabilities to grow around it. With the HP ME series CAD systems, you can easily build on that foundation and add expanded capability as your requirements grow.

ME Series integration capabilities include:

- Parts list information for stock control systems
  - Drawing data included in documentation systems
  - 2D geometry link to NC programming systems
  - IGES 2D bidirectional translator
  - DXF bidirectional translator
- ME Series 30 ADDITIONAL integration capabilities include:
- 3D geometry link to finite element analysis systems
  - IGES 3D output
  - VDA-FS output providing trimmed parametric surface data

### HP's Proven Platform: Hardware and Support

The HP ME series CAD systems support a complete set of price/performance-leading computers. These networkable systems range from MS-DOS\*-based HP Vectra computers to UNIX\*\*-based HP workstations and superworkstations. With a large selection of peripherals and graphics displays, HP offers a complete CAD solution.

Networking capabilities such as LAN enable users to set up a distributed system featuring both products to address the full range of mechanical engineering CAD requirements. Networking capabilities further integrate CAD stations into manufacturing environments.

### Training

A complete set of training courses is available for the ME Series 10 and 30 to help your engineers become increasingly productive. Structured to match the increasing capability of the ME Series CAD family, the courses allow you to choose the correct level of training for each engineer. Additional training in your environment is supported by engineering consulting and a comprehensive set of documentation.

HP offers a range of services to ensure that the initial period after system delivery is trouble free. HP engineers are available to install all components of your CAD system. They also will tailor the system to your specific needs.

Your local HP sales office has full details of the training and support programs available in your area. Contact them for details.

### Ordering Information

For up-to-date ordering and pricing information you should contact your local HP sales office (see page 737).

\* MS-DOS is a U.S. trademark of Microsoft Corporation

\*\*UNIX is a trademark of AT&T in the U.S.A. and in other countries

HP ME Series 10 is an advanced 2D design and drafting system for mechanical engineering applications. ME Series 10 runs on HP engineering workstations under the HP-UX operating system and, as shown here, HP Vectra RS 32-bit PC workstations under the MS-DOS operating system.

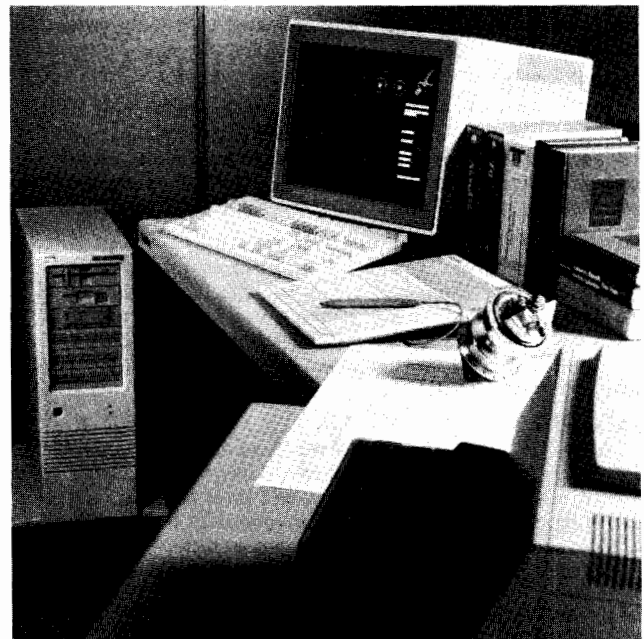

# DESIGN AUTOMATION

**ME DesignCenter**  
ME VAB Products

## UNIGRAPHICS

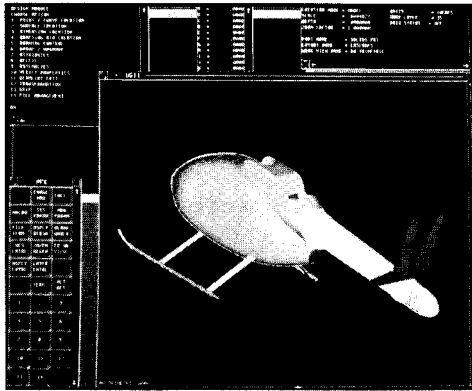

UNIGRAPHICS®

UNIGRAPHICS, a product of McDonnell Douglas, is a 3-dimensional, interactive, fully integrated set of solutions for the engineering, design, and manufacturing of mechanical parts and/or assemblies. Backed by a company with over 20 years of experience in the development of interactive graphics systems for CAE/CAD/CAM, UNIGRAPHICS is based on a single engineering and manufacturing database, providing for a seamless flow from concept to finished product.

UNIGRAPHICS includes a fully integrated product line from 2-D design and drafting, to 3-D wireframe/surfaces/solids, to manufacturing/factory production. It provides state-of-the-art, complex, 3-D N.C. machining capability and an integrated, solid modeler that supports free-form surfaces. It includes integrated quality control and shop floor management software from Valisys Corporation. Worldwide sales and support is available.

## ABAQUS

ABAQUS is a general-purpose, finite element program for advanced linear and nonlinear engineering analysis. The program has general geometric modeling capabilities, a library of materials, and a range of procedures. It is designed for complex problems and has a simple input language and a range of postprocessing options.

## ADAMS

ADAMS (Automatic Dynamic Analysis of Mechanical Systems), a product from Mechanical Dynamics, Inc., is a linear and nonlinear program for analysis of systems that move. ADAMS computes kinematic, static, dynamic, and modal behavior of mechanical systems by computing displacements, forces, velocities and accelerations. The results can be plotted or graphically animated to visually review the analysis.

## ANVIL-5000\*

ANVIL-5000, a product from Manufacturing and Consulting Services, Inc., is a complete system for design, drafting, finite element pre- and post-processing, and manufacturing. Modules include 3D design/drafting, surface modeling, solids, finite elements, graphics programming language and numerical control manufacturing.

## BEASY

BEASY, a product of Computational Mechanics, Inc., is a general-purpose computer aided engineering package for the solution of a wide range of problems in heat transfer, stress analysis, and electrostatics. Fully interactive, color pre- and postprocessors are supplied as part of the BEASY system, to assist the tasks of generating models and interpreting results.

## CAMAND

CAMAND from CAMAX Systems, is an integrated CAD/CAM solution with a focus on Computer Aided Manufacturing. The software includes Surface Modeling, and specializing in multi-axis machining. CAMAND is suitable for companies who use NC machines to manufacture parts requiring complex surfacing. CAMAND is designed to co-exist with other CAD systems, such as HP's ME Series 30.

UNIGRAPHICS is a registered trademark of McDonnell Douglas  
\*ANVIL-5000 is a trademark of Manufacturing and Consulting Services, Inc.

## CIM CAD/CAM/SURF

CIM CAD/CAM/SURF/ID from CIMLINC provides integrated, interactive, graphical solutions for 2D/3D design, manufacturing, and CIM. The graphical NC Programming solutions provide 2½-5 axis contouring to multi-surface avoidance.

## DADS

DADS, a product of CADSI, is a mechanical computer aided engineering (MCAE) software package that performs static, dynamic, inverse dynamic, and kinematic analyses. It provides a cost-effective computer simulation tool for predicting the real world behavior of complex mechanical systems without the need to construct physical prototypes.

## ESPRIT

ESPRIT, a product of D.P. Technology Corp., is a CAD/CAM/CIM system for HP-UX based workstations and MS-DOS based computers. It is a complete 3-D design and graphical NC part programming system. ESPRIT supports all major NC machining disciplines including chip making, sheet metal fabrication, and non-traditional machining; sheet metal flat pattern development; and DNC/shop floor networking.

## FLUENT®

FLUENT, a product of Creare Inc., is a fluid flow simulation program that models behaviors of fluid flow and heat transfer. Applications include combustion, aerodynamics, particulates, computer chip manufacturing, electronic equipment cooling, heat exchangers, and chemical and process operations.

## GNC

GNC, a product of CADCentre Limited, is an interactive graphical solution for developing part programs supporting all major NC machining disciplines. 2½ to 5 axis machining, surface modeling, and customizable post processing provide an extensive range of capability resulting in increased productivity from rapid development of accurate and correct NC part programs. Integration with HP's ME Series 10/30 and a common user interface provides a premier CAD/CAM solution.

## PATRAN



PATRAN®

The PATRAN system, a product of PDA Engineering, is an open 3D Mechanical Computer Aided Engineering (MCAE) system for modeling, analysis and results evaluation. It uses a common geometric database and user interface for all design, imaging, finite element modeling and analysis requirements. Industry application areas include aerospace, automotive, defense and electronics. The PATRAN system offers complete analysis capabilities in thermal, structures, fluids, kinematics, and large displacement dynamics. It provides gateway interfaces to all major design and analysis codes, accurate analytical functionality, and efficient post-processing for rapid design interpretation. Superior worldwide training and support ensures customer satisfaction.

FLUENT is a registered trademark of Creare Inc.  
PATRAN is a registered trademark of PDA Engineering



### I-DEAS

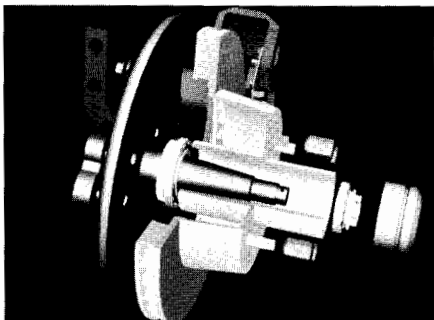

I-DEAS™

The I-DEAS™ (Integrated Design Engineering Analysis Software) system from SDRC is solids-based and simulation-driven to address the product development activities of an entire engineering organization. I-DEAS contains software modules for solid modeling, design, finite element modeling and analysis, drafting, testing and manufacturing. Each module is a market leader, providing the high functionality needed to be on the critical path of your product development process.

**I-DEAS for Design** is the module for solid modeling, system assembly, mechanism design, & drafting/documentation

**I-DEAS for Analysis** is the module for finite element pre- and post-processing, model solution, laminate composite material & thermal modeling, plastic mold analysis, and system noise and vibration analysis.

**I-DEAS for Test** is the module for general test data management and analysis, specialized signal processing, rotating machinery, model, fatigue and system dynamic analysis.

### MARC

MARC™ is a general-purpose finite element program that performs both linear and nonlinear analysis. The program handles large strain and displacement problems such as creep and buckling, and incompressible material behavior. MENTAT™ Interactive Graphics pre- and postprocessor for MARC provides an integrated set of tools for model development and verification, and for results presentation.

### MOLDFLOW

Moldflow, a product from Moldflow Australia Pty. Ltd, analyzes the flow of thermoplastics into an injection mold at the instant of filling by calculating the heat transfer and fluid flow equations inherent in the injection of hot plastics into a cold mold. MOLDFLOW programs are a tool that enables injection mold and part designers to design molds and parts by predicting the flow pattern of the plastics into the mold.

### MSC/NASTRAN

MSC/NASTRAN, a product of MacNeal-Schwendler Corp., is a large-scale general purpose finite element program that solves a wide variety of engineering analysis problems. Nastran solves static and dynamic structural analysis, material and geometric nonlinearity, heat transfer, aeroelasticity, acoustics, electromagnetism and other types of field problems.

### NISA II

NISA II, a product of Engineering Mechanics Research, provides extensive linear and nonlinear analysis of static, dynamic and heat transfer problems. The NISA family also includes NISA-Composites, NISA/3D fluid, and NISAOPT, a structural and shape optimization program.

### MSC/PROBE

PROBE, a product from The MacNeal-Schwendler Corp., is a p-version finite element analysis system for elastic, thermoelastic, fracture, modal, and heat transfer analyses. PROBE allows repeated design/analysis iterations, increasing the efficiency of the engineering process.

MARC and MENTAT are trademarks of MARC Software International, Inc. MOLDFLOW is a registered trademark of Moldflow Australia Pty.Ltd.™ SDRC and I-DEAS are trademarks of Structural Dynamics Research Corporation.

### Pro/ENGINEER

Pro/ENGINEER, a product from Parametric Technology Corporation, is parametric, feature-based solid modeling system that supports interactive design modifications to models of mechanical assemblies and parts, including tooling and fixtures. Other features include ANSI standard drafting, assembly management, advanced modeling tools, CAD/CAM translators, and automatic finite element meshing.

### SABRE-5000

SABRE-5000, a product of Gerber Systems Technology, Inc., is a turnkey, high performance CAD/CAM system for improving manufacturing productivity in a wide range of aerospace, automotive, heavy machinery, tool and die, and modeling applications. The system includes interfaces to finite element modeling/analysis packages and translators for exchanging design and manufacturing information between different data bases including IGES, Ford, GM, Chrysler and VDA/Bezier data converters.

### SMP-81

SMP-81, a product of Merry Mechanization, is a sheet metal specific CAD/CAM package for assisting fabricators in developing the flat layout and NC punching information needed to manufacture parts by turret punching and brake forming operations. It has a direct link to HP's ME 10 and 30.

### UAI/NASTRAN

UAI/NASTRAN, a product from Universal Analytics, is a large-scale, general-purpose finite element analysis program for static and dynamic structural analysis, buckling, and steady state and transient heat transfer analysis including modeling of conduction, convection, and radiation.

### VersaCAD DESIGN

VersaCAD DESIGN, a product of Versacad Corporation, is a fully programmable, interactive computer aided design and drafting software package. Features include interactive 2D drafting or 3D modeling, light source color shading, bill of materials reports, and two-way CAD translators.

### ANSYS®

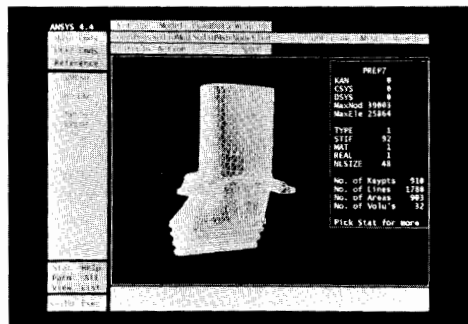

ANSYS®

ANSYS, a product of Swanson Analysis Systems, Inc., is a general-purpose finite element analysis program for solving structural, thermal, fluid, electrical, and electromagnetic applications. ANSYS integrates preprocessing, solution, and postprocessing in one package. The program includes solids modeling, design optimization, coupled analyses, fluid flow, and multifield elements, and provides an easy-to-learn user interface. It is used worldwide for a variety of applications, including automotive, aerospace, electronics, manufacturing, medical, and transportation. ANSYS is available on PCs, workstations, and compute servers, and it can be ported between platforms.

ANSYS is a registered trademark of Swanson Analysis Systems, Inc.

# SOLID STATE DEVICES

## Components

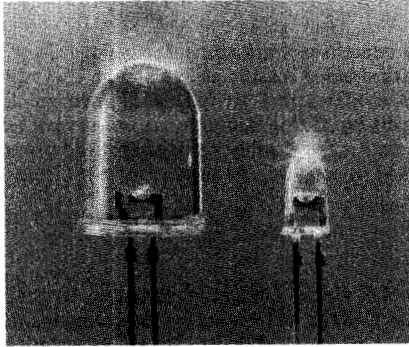

TS AlGaAs LEDs

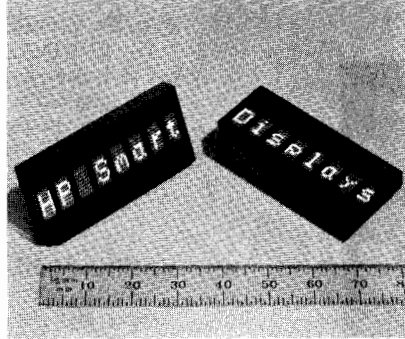

Intelligent Displays

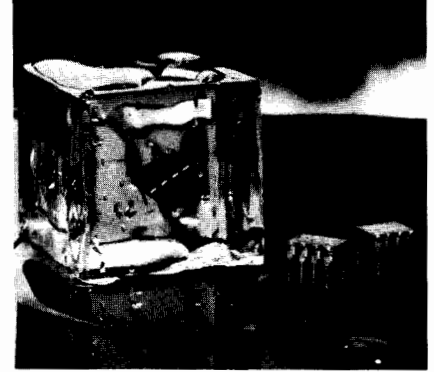

Hermetic Optocouplers & Solid State Relays

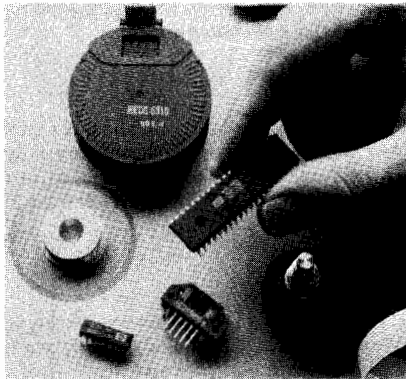

Motion Control Components

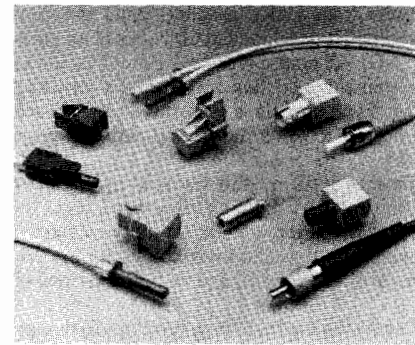

Fiber Optic Components

### LED Solid State Lamps, Light Bars & Arrays

Hewlett-Packard is a world leader in LED technology and offers a broad variety of LED indicator products. Products are available in high-performance green, yellow, orange, high-efficiency red, and standard red. Recent advances in fundamental semiconductor material development have allowed new areas of contribution. New AlGaAs red materials are the basis for recent low current and very high brightness (1 candela at 20 mA) additions to the product line. New hermetic products include infrared-secure lamps intended for advanced military applications.

### Solid State Displays

Hewlett-Packard offers a complete line of seven-segment displays in AlGaAs red, standard red, high-efficiency red, yellow, and high-performance green in a wide variety of package sizes. The newest members are low-current micro bright displays in red, yellow, and green.

LED alphanumeric displays in monolithic and dot matrix versions are also available. Recent developments used on-board integrated circuits (OBIC) to provide more sophisticated functions and capabilities to these displays. Some of these rugged displays are screened and tested for use in military applications and harsh environments.

The aesthetic appearance and reliable performance of LED displays make them appropriate for use in instruments, point-of-sale terminals, appliances, automobiles, telephones, moving message panels, and other high-ambient light front-panel displays.

### Motion Control Components

Hewlett-Packard's developments in III-IV materials, integrated circuits, lenses, and

packaging allow for a natural expansion of these efforts into development of optical incremental shaft encoders. The first HP shaft encoder was introduced in 1981. Since then, the product line has expanded to include a broad range of motion-sensing and control components.

HP's motion-sensing products include 2- and 3-channel kit encoders for commercial and industrial applications, 2-channel encoder modules for high-volume computer peripheral applications and digital potentiometers to replace analog potentiometers for manual data entry in medical and measurement instrumentation.

HP's motion control products include a quadrature decoder/counter integrated circuit for easy interface of an encoder to a microprocessor and a general-purpose motion control IC, which acts as a slave processor in closed-loop servo systems.

### Optocouplers

Hewlett-Packard's family of logic compatible, high-performance optocouplers provides solutions to problems caused by ground loops and induced common mode noise for both analog and digital applications in commercial, industrial and military products.

Types of optocouplers available include high-speed and high-gain devices ac/dc to logic interface optocouplers, and optocouplers which interface directly with microprocessors.

### Solid State Relays

As an extension of the high performance logic compatible optocoupler family, Hewlett Packard offers miniature, dual-in-line package solid state relays for small signal, and low power switching applications. HP's solid state relays are replacements for low

current electro-mechanical relays in both commercial and military equipment.

### Fiber Optic Components

Hewlett-Packard offers three families of fiber optic components which include transmitters, receivers, cable, connectors and connector assembly tools.

### Plastic Snap-In Link Components

Low cost and ease of use make this family of link components well-suited for applications connecting computers to terminals, printers, plotters and industrial-control equipment. These links use rugged, 1 millimetre diameter plastic fiber cable. Assembling the plastic snap-in connectors onto the cable is extremely easy. The HFBR-0500 evaluation kit contains a complete working link including transmitter, receiver, 5 metres of connected cable, extra connectors, polishing kit and technical literature.

### Miniature Link Components

The miniature link family of components offers a wide range of price/performance choices for local area network, computer, industrial-control, and military applications. The unique design of the lensed optical coupling system makes this family of components very reliable. The low-cost miniature line features a dual-in-line package that requires no mounting hardware or receptacle for use with SMA-style and ST\*-style connectors. Evaluation kits are available for this line. The HFBR-0400 kit contains an SMA-styled transmitter and receiver, two meters of connected cable, and technical literature. The HFBR-0410 kit contains an ST\*-styled transmitter and receiver, three meters of connected cable, and technical literature.

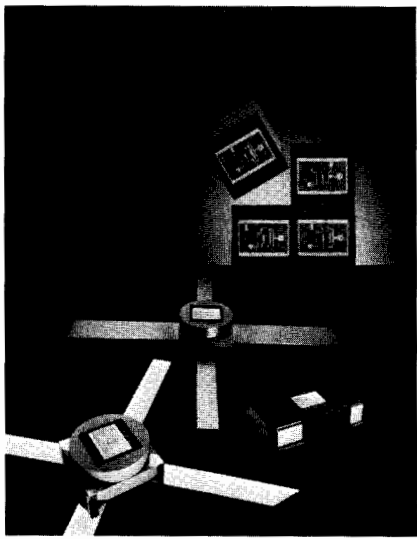

Hybrid Cascadable Amplifiers

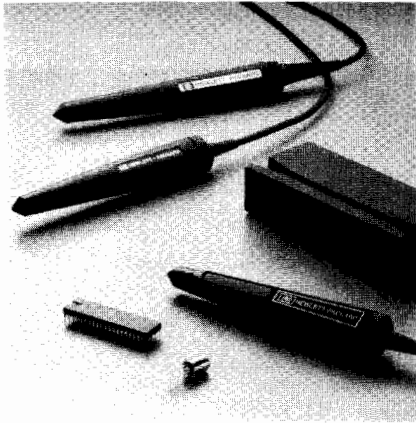

Bar Code Components

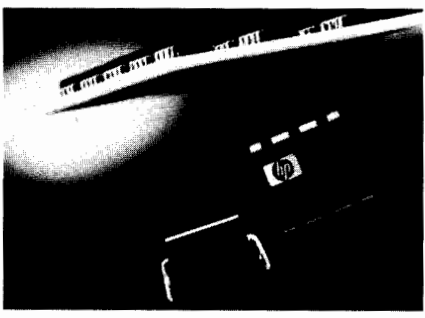

Surface Mount Optocouplers & Solid State Relays

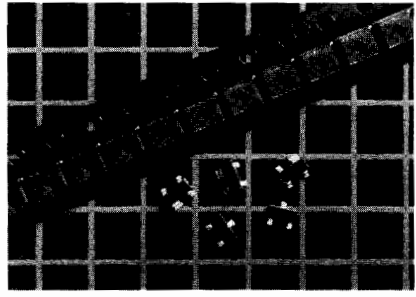

Bipolar Transistors

**Silicon Bipolar Transistors**

Device-to-device uniformity and superior performance are combined in the HXTR series of microwave transistors which have been individually designed for low noise (HXTR-6000 series), high gain (HXTR-2000 series), low distortion linear power (HXTR-5000 series). With guaranteed RF performance specifications from 1000 to 4000 MHz, these devices are well suited for high-reliability, space military, and industrial applications at frequencies up to 6000 MHz.

**Diodes**

**Schottky Barrier Diodes:** Schottky Barrier Diodes combine extremely high rectification efficiency with picosecond switching speeds, low series resistance, and low noise characteristics. This combination makes the Schottky an excellent mixer/detector diode.

**PIN Diodes:** PIN diodes function as variable resistors at microwave frequencies. By controlling the dc bias, the RF resistance of a PIN diode can be varied from 1 ohm to about 10 ohms. This property of the PIN diode makes it extremely useful as a switch attenuator, modulator, phase shifter, limiter, or AGC element at all frequencies from 1 MHz to 18 GHz and above.

**Step Recovery Diodes:** The step recovery diode is most graphically described as a charge-controlled switch. That is, a forward bias stores charge and a reverse bias depletes

this stored charge. When fully depleted, the SRD ceases to conduct current.

**Diodes for Hybrid Integrated Circuits:** These diodes are used to achieve circuits with light weight, small size, operation to high frequencies, repeatable characteristics, and lower end-product costs. HP offers a wide range of PIN, Schottky and SRD single diodes in beam lead and chip configurations as well as Schottky silicon and GaAs beam lead pair and quad diodes.

**Integrated Products:** Hewlett-Packard manufactures a broad line of components for the control, conversion, and generation of RF and microwave signals. This line of integrated products (combinations of chip and beam lead diodes with hybrid thin film circuit technology) includes SPST switches, attenuators, comb generators and double-balanced mixers. In addition, Hewlett-Packard manufactures monolithic silicon RF amplifiers and GaAs attenuator modules.

**Bar Code Products**

Designed to meet the OEM's bar code needs, Hewlett-Packard's bar code line includes digital bar code wands, two decoder IC's, optical reflective sensors, slot readers, and bar code readers. The expanding line of digital wands contains HP's Low Current Digital Bar Wand, which draws less than 5 mA of current at 5 volts, and the HP Smart Wand, an optical programmable contact bar

code reader that provides bar code capability to host systems supporting a 5V serial interface. The Digital Slot Reader, introduced in 1986 and available in both an infrared (880 nm) and a visible red (660 nm) version, is ideal for use in security or industrial applications. The Multi-Purpose Decoder IC offers a simple and inexpensive solution of adding bar code decoding capabilities to OEM products.

**High Reliability Testing**

Many Hewlett-Packard components are space qualified. The reliability of these devices is established by one of the finest high reliability testing facilities in the component industry. Hewlett-Packard's High Reliability Test Groups maintain military-approved parts in stock and can recommend HP standard screening programs, patterned after MIL-S-19500, MIL-M-38510, or MIL-D-87157 for any HP component.

**Write For More Information**

Specifications of Hewlett-Packard's component products are available in individual data sheets or complete designer catalogs. These are available free of charge from your local HP sales office or authorized distributor, or return the Information Request Card located at the back of this catalog.



# ANALYTICAL INSTRUMENTS FOR CHEMICAL ANALYSIS

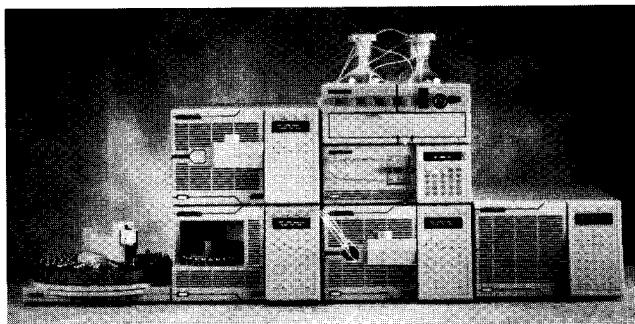

HP 1050 Series HPLC Modules

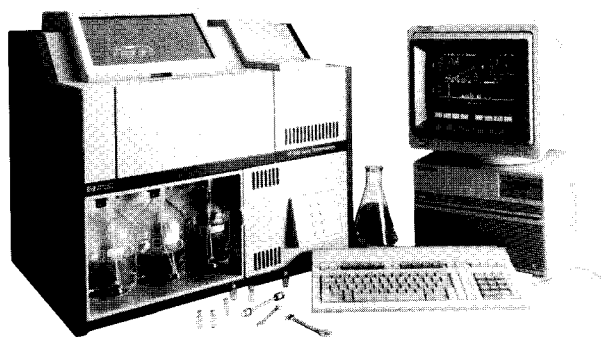

HP 1090M LC with LC ChemStation (Pascal Series)

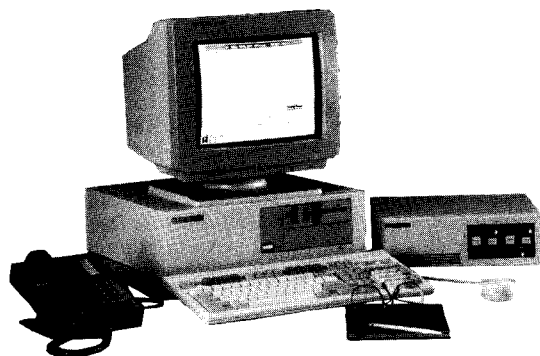

HP 3365 ChemStation (MS DOS Series)

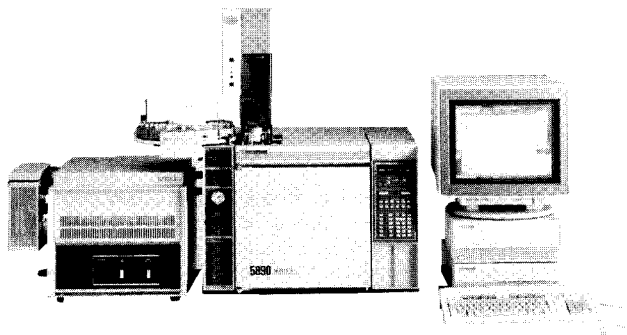

HP 5970B GC/MS with MS ChemStation (HP-UX Series)

## LC Chromatography

The HP 1090M LC is a fully integrated HPLC system with advanced data handling capabilities. Simultaneous data acquisition and evaluation saves hours. The 1090M is especially useful in methods development, purity verification, and problem solving. The HP 1090L LC provides instrument control from a single keyboard. It is ideal for routine analysis where high throughput is paramount.

## HPLC Pumps and Autosamplers

With HP 1050 module LC pumps, you can add capabilities one module at a time. Modules include the HP 1050 Isocratic Pump, using variable stroke design for superior flow stability; the HP 1050 Quaternary Pump, which will deliver up to four solvents separately; and the HP 1050 Autosampler, which is compatible with any modular HPLC system.

## LC Detectors

HP's standards for quality and reliability extend to our line of HPLC detectors, which include the HP 1049A Electrochemical Detector, the HP 1050 Multiple Wavelength Detector, the HP 1050 Variable Wavelength Detector, the HP 1040 Diode Array Detector, the HP 1047A Refractive Index Detector, and the HP 1046A Fluorescence Detector.

## Bioanalytical

HP offers a number of turnkey bioanalytical solutions. The HP Aminoquant Amino Acid Analyzer is precise, accurate, and sensitive; both the chemistry and the chromatography are ensured. It is fully automated, and most errors are eliminated. The HP Microassay system brings robotic automation that provides reliability, accuracy, and high throughput on ELISA and other microtiter plate applications.

## UV/Visible Spectroscopy

HP diode-array spectrophotometers provide more information by acquiring data at all wavelengths simultaneously. The HP 8452 UV/Vis Spectrophotometer with MS DOS controller provides virtually instant spectra from 190 to 820 nm and exceptional reliability. The HP 8452 UV/Vis Spectrophotometer with HP 89550A Dissolution Testing software combines advanced analytical features with simple, secure operation.

## Data Handling

The HP Unified Laboratory is an advanced strategy that increases analytical productivity. It encompasses the full range of HP analytical instruments and data handling solutions from integrators to LIMS, plus standard networking. In Integrators, HP has set the standard and makes one of the lowest-priced, most cost-effective integrators on the market today. The HP ChemStations are single-user workstations that combine instrument control, data evaluation, and reporting. They provide single instrument control for UV, LC, GC, GC/MS, LC/MS and GC/IRD; plus multi-instrument control for GC and LC. The HP Laboratory Automation System provides a flexible multi-user system for high-volume routine analysis; automating the entire process -- from data acquisition to final report. The HP Laboratory Information Management System provides a solution to complex information management needs. It improves information and sample flow, coordinates results from multiple analytical techniques and links manufacturing, QA and other corporate information management systems to you.

### Gas Chromatography

The HP 5890 Series II handles even the most demanding applications with ease. Includes cool on-column inlet for faster, more precise analysis. Pressure programming for low-temperature analysis and constant flow. And a high temperature oven for analyzing higher molecular weight compounds.

### HP Mass Selective Detectors

Universal, sensitive, reliable and easy to use, the HP 5970B and HP 5971A MSD's provide sensitive detection over a range of compounds and the economically priced HP 5971 makes it possible for any lab to afford MS technology.

### HP 5921A Atomic Emission Detector

The 5921A is the first fully automated benchtop system capable of detecting elements that were previously difficult — even impossible — to detect. Oxygen, organometallics, carbon, and sulfur for example.

### GC Sample Introduction/Management Systems

HP offers several proven solutions for automated sample handling. The HP 7673 Automatic Injector and Sampler offers discrimination-free injection of up to 100 different samples. Advanced robotics and the ability to add a second injector and HP 18587A Bar Code Identification system make it simple and virtually trouble-free. The HP 19395A Headspace Sampler eliminates many sample workup and extraction steps and can be used with any packed or capillary technique.

### HP 7680A Supercritical Fluid Extractor

The HP 7680A SFE is a graphics-driven, computer-controlled instrument designed for automated extraction of complex samples. SFE replaces time-consuming liquid-solid extraction techniques with rapid and reproducible supercritical fluid CO<sub>2</sub> extractions.

### Mass Spectrometry

HP's line of low-cost mass spectrometer products makes it possible for virtually every lab to afford high-quality GC/MS. The HP 5971A with MS DOS controller provides PC-controlled MSD and makes GC/MS accessible wherever needed. High-performance features include multitasking for simultaneous data acquisition and analyzing, classical EI spectra and Microsoft Windows for ease of use. The HP 5970B GC/MS with MS ChemStation is a multitasking networking system using UNIX, X-Windows software to control the world's most widely used MSD.

### GC/FTIR

The HP 5965B GC/IRD and HP 5890 Series II GC makes capillary GC/FTIR routine. It is an easy-to-use solution to a broad range of problems. A standard array processor gives you real-time spectra and selected wavelength chromatograms with increased sensitivity. The HP GC/FTIR/MS with 5890 Series II GC and HP 5970 GC/MS gives you the combined power of GC/MS and GC/FTIR and provides the ultimate in organic compound analysis.

### Columns/Supplies/Software

HP is one of the few analytical instrument makers to offer a comprehensive line of competitively priced, high-quality supplies, accessories, LC and GC columns, and consumables. In addition, HP offers dedicated software to provide turnkey solutions.

### If you would like to know more

Just call your local HP sales office or distributor and ask for the analytical products representative.

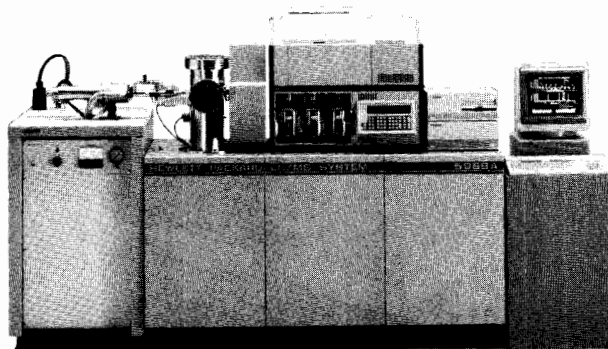

HP 5988A LC/MS with Particle Beam



HP 5971A GC/MS with ChemStation (MS DOS Series)

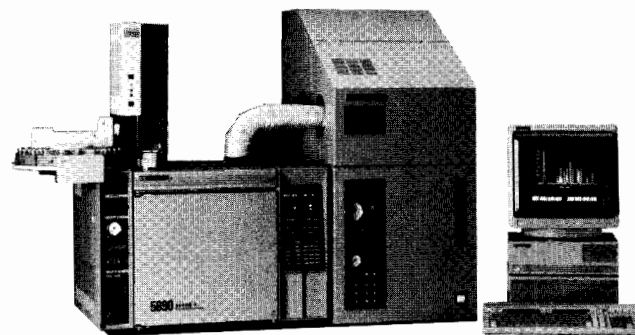

HP 5921A Atomic Emission Detector

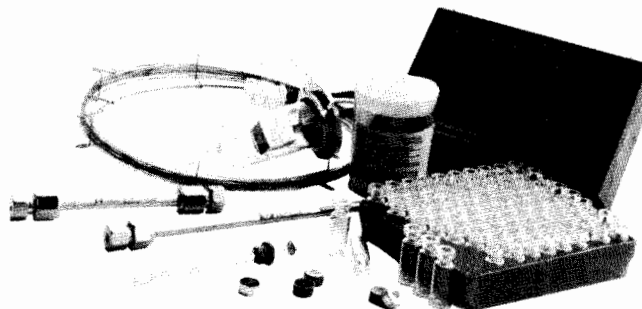

Analytical Columns and Supplies

# MEDICAL INSTRUMENTATION

## Diagnostic Cardiology and Echocardiography

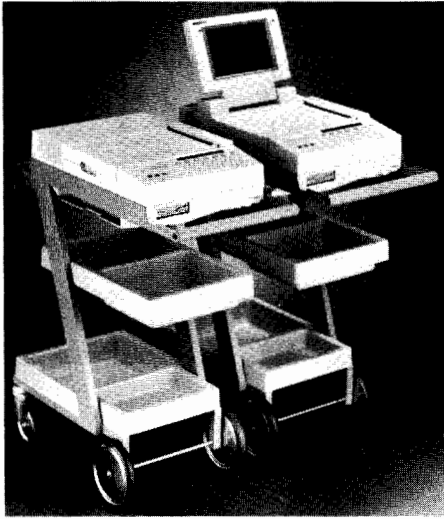

### Cardiology Instrumentation

- HP PageWriter XLi advanced cardiograph with interpretive capability and preview display
- HP PageWriter XLs standard, real-time cardiograph
- ECG Management Systems for computer-aided management of electrocardiograms
- ECG Workstations for PC-based ECG department management



### Ambulatory ECG

- True, two-channel analysis and ST-segment measurement
- System includes HP Vectra PC, custom software, two patient analyzers and an HP LaserJet Series III printer
- Optional HP 43405A Memory Module for full disclosure

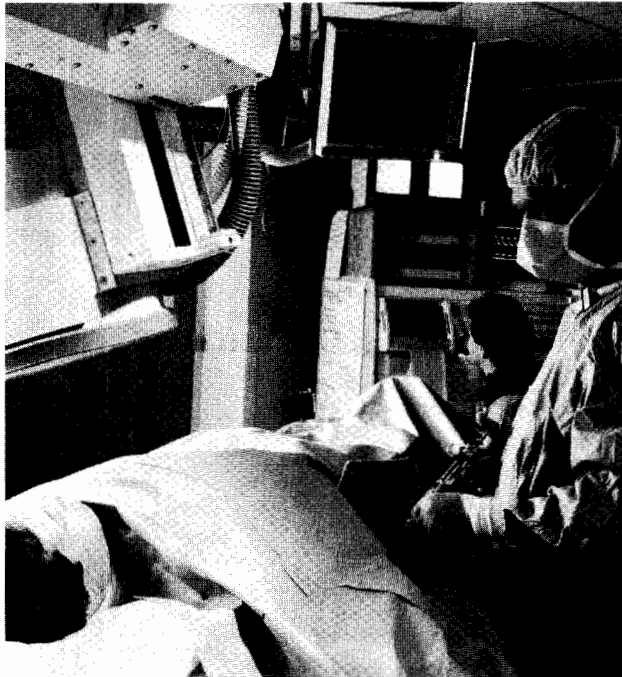

### Cardiovascular Instrumentation

- Computerized catheterization data analysis system automates on-line data collection analysis
- Comprehensive data base for generating both clinical and administrative reports
- Complete choice of plug-in signal conditioners and transducers

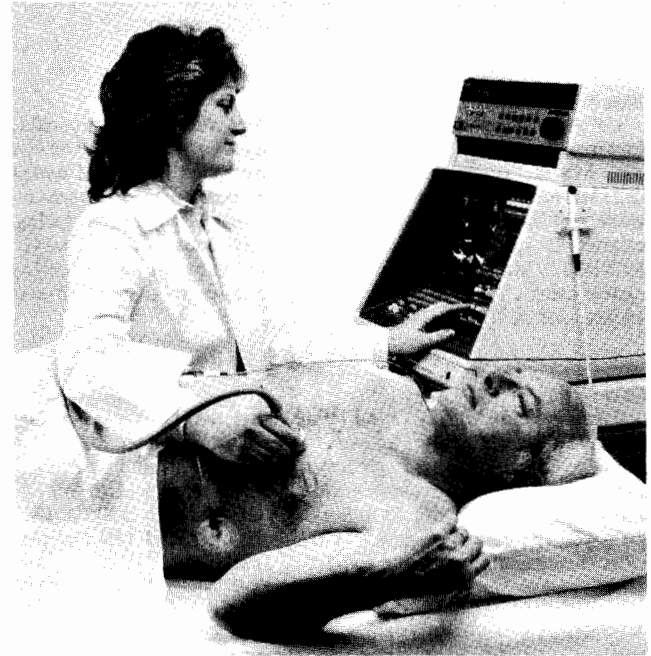

### HP SONOS 1000 Cardiovascular Imaging System

- The most advanced HP phased array ultrasound imaging system
- HP Precision Imaging technology and wide-aperture transducers
- Peripheral vascular imaging with 7.5 MHz linear array transducer
- Next-generation color flow imaging
- Steerable PW/CW Doppler
- Transesophageal imaging capability
- Sophisticated image review and analysis capabilities

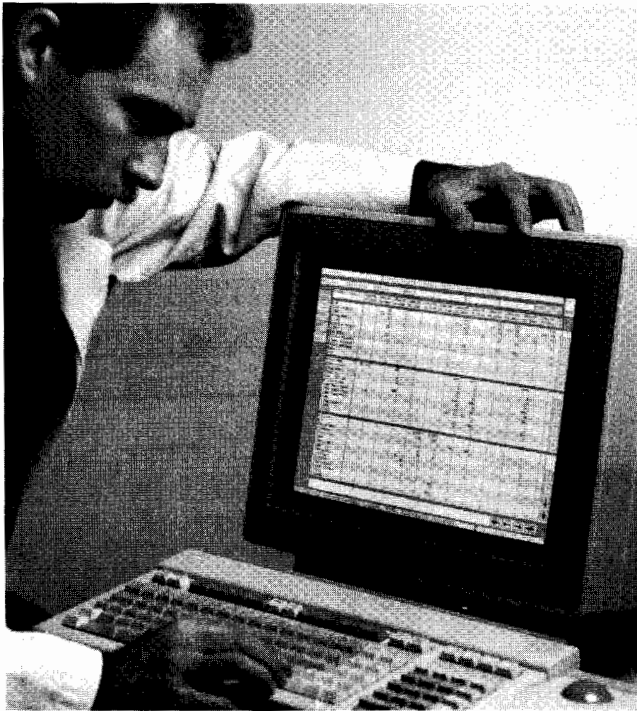

### HP CareVue 9000 Clinical Information System

- Bedside-oriented system for critical care
- Replaces paper-based charting process
- Easily adapted to each unit's specific needs
- Advanced human interface
- Collects information directly from bedside monitors and other bedside devices
- Uses local area network to incorporate information directly from ancillary departments
- Applications include flowsheet, nursing/physician notes, nursing care plans, patient acuity, severity of illness and more



### Obstetrical Information Management System

- Display and Alert
- Remote overview screens
- Bedside data entry
- Configurable admission/discharge forms
- 25-year storage, retrieval and archiving
- Flexible system configurations

### Other Obstetrical products include:

- Antepartum fetal monitors
- Intrapartum fetal monitors
- Fetal ultrasound telemetry
- Fetal trace transmission system

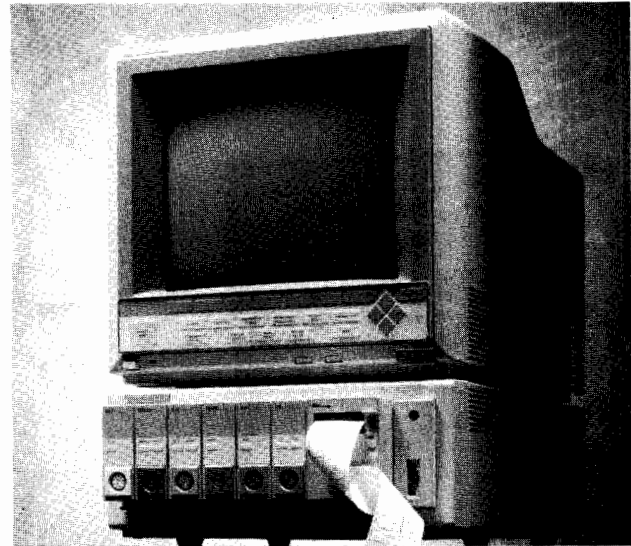

### HP Component Monitoring System

- Patient monitoring system for the OR, CCU, and ICU
- Monitors up to 16 parameters simultaneously
- Choose 4, 6, or 8 waveforms, color or monochrome
- Intuitive, 2-levels of operation
- Comprehensive data management
- Interface to HP Critical Care Network



### Resuscitation

- Easy to use, 3-step operation
- Lightweight, reliable design

For Additional Information on HP Medical instrumentation, write to INQUIRIES MANAGER, Hewlett-Packard, 3000 Minuteman Road, Andover, MA 01810, and request literature in any of the following categories:

- Patient Monitoring Systems
- OR Monitoring
- Arrhythmia Central Stations
- Clinical Information Systems
- Ultrasound Imaging
- Cardiography Instrumentation/Ambulatory ECG
- Cardiovascular Instrumentation
- Obstetrical and Neonatal Instrumentation
- Resuscitation
- Healthcare Information Systems
- Supplies, Consumables, Pressure Transducers

We invite you to receive ADVANCES FOR MEDICINE, the Hewlett-Packard medical products magazine, free of charge.

Simply write to: ADVANCES FOR MEDICINE

Hewlett-Packard  
3000 Minuteman Road  
Andover, MA 01810

# X-RAY EQUIPMENT

## Cabinet X-Ray Systems

Models 43855A, 43855B and 43856A

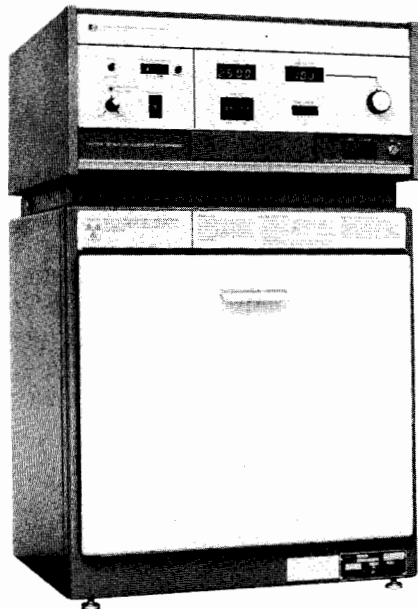

FAXITRON MODEL 43855A  
WITH OPTION A02

### Faxitron® Cabinet Systems

Radiography, the art and science of making pictures with X-rays, has an important place in modern technology. It is one of the major nondestructive test methods available to industry, provides an indispensable tool in scientific investigations and is a valuable aid to law enforcement agencies. Hewlett-Packard makes a major contribution to these activities with X-ray equipment that offers a "better way" through advanced technology and design. This equipment makes radiographs easier and safer to take.

### Scientific Applications

Oceanography, geology, marine biology, paleontology, pathology, botany, forestry and agricultural research are a few examples of scientific disciplines that use X-rays. Applications range from the study of the interior anatomy of fossils to determining the viability of seeds.

These are among the many applications served by HP Faxitron Cabinet X-ray Systems. They offer a unique combination of high quality radiographic capability, simplicity of operation and convenience of use which is expanding the capabilities of scientific and industrial concerns throughout the world.



FAXITRON MODEL 43856A

### Industrial Inspection

Industrial quality control and inspection procedures, especially in the field of electronics, benefit from nondestructive testing by radiography. The advantages of a testing method which does not harm the test objects are obvious. Radiography, therefore, offers benefits in design engineering, incoming inspection, production quality control, product reliability and failure analysis. X-rays are used to detect misregistration or plate-thru problems in multi-layer P.C. boards; porosity, poor substrate bonding and wiring or lead location in transistors and integrated circuits; voids and other encapsulation problems in potted components; and solder balls or other defects in sealed relays.

Die casting is another industry that benefits from the nondestructive aspects and ability to "see inside" provided by radiography. Porosity, gas void, trapped metal inclusion and other common defects can be easily detected and the cause determined. Expensive machining time can be avoided for castings found to be defective through X-ray inspection. The integrity of welds, alignment of connectors, inspection for proper assembly and mechanical defects are further examples of tests which radiography performs for industry. The benefits of X-ray testing are reduced production costs, better quality assurance and product safety. The results are increased profits.

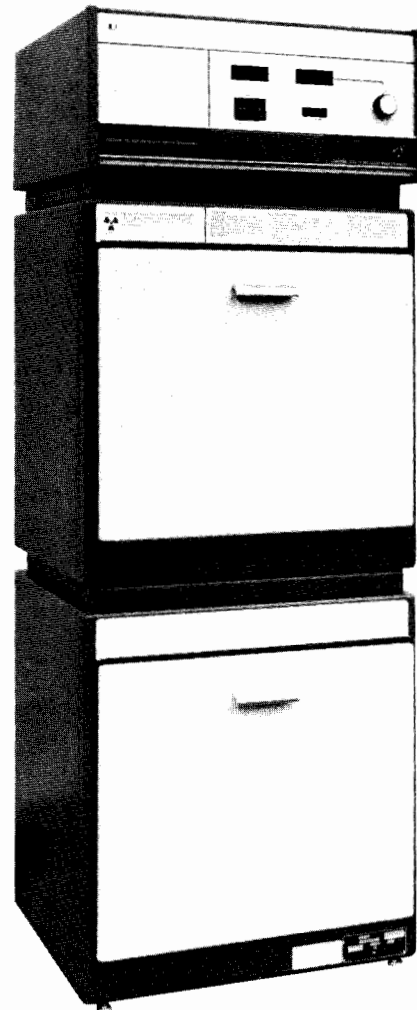

FAXITRON MODEL 43855B

### Medical Applications

HP Faxitron Cabinet X-ray Systems are used by the medical profession for specimen radiography in support of diagnostic surgical procedures and in biological research. Specimen radiographs of biopsy samples are correlated with preoperative mammograms, for example, and in the evaluation of mastectomy specimens. Typical research applications include microradiography of thin bone specimens and microangiographic studies of vasculature.



# X-RAY EQUIPMENT

## Flash X-ray Systems

673

HP 43703B, 43710A, 43731A, 43733A, 43734A

MODEL 43731A  
150kV

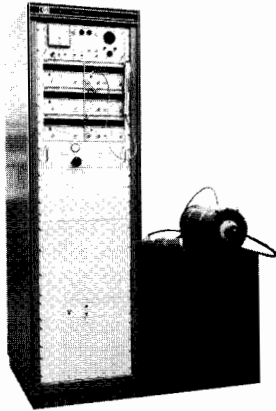

MODEL 43733A  
300kV

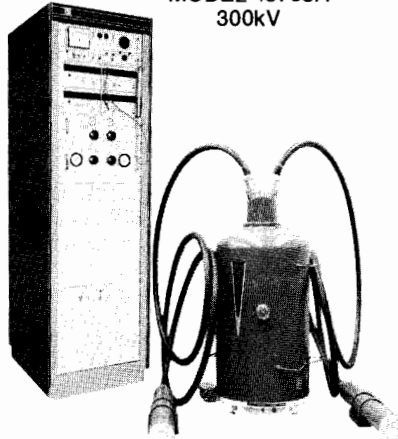

MODEL 43734A  
450kV

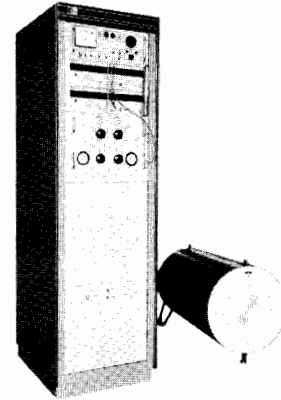

Option 035 - Dual Remote Tubehead

High-speed (flash) radiography is used to record and study dynamic events where interposed material, smoke, flame, debris, or pressure variations exclude the use of high-speed cameras. Typical events include ballistics, shaped charges, explosives, behind-armor studies, shock waves in solids, aerospace phenomena, and crash-injury studies.

The basic performance requirement of a flash X-ray system used for the study of transient mechanisms is to provide high resolution radiographs with exposure times short enough to eliminate motion blur. HP series 43700 Flash X-ray systems produce X-ray pulses of sub-microsecond duration and are designed specifically for "stop motion" radiographic applications. All HP 43700 series systems utilize the same basic components, the same electrical theory, and are modular in concept. Standard systems include 150 kV, 300 kV, 450 kV, 1 MV, and 2.3 MV models.

An HP basic single "channel" flash X-ray system, composed of a pulse generator, high voltage power supply, cold-cathode field emission X-ray tube, and associated controls, provides a single radiograph per event. Additional pulser/X-ray tube sets (add-on channels) may be combined with the initial single-channel system to provide multiple-channel "systems." Multiple channel systems may be of identical output voltage or may use varied output voltage pulser/tube combinations.

For specific information and consultation regarding HP X-ray systems, contact Hewlett-Packard, 1700 S. Baker Street, McMinnville, Oregon 97128. Telephone (800) 952-2212.

**ROCKVILLE (Sales)**  
#2 Choke Cherry Road  
Rockville, Maryland 20850  
Telephone (301) 948-6370

**ALBUQUERQUE**  
7801 Jefferson Street, N.E.  
Albuquerque, New Mexico 87109  
Telephone (505) 823-6100

**FULLERTON**  
Hewlett-Packard Company  
1421 S. Manhattan Ave.  
Fullerton, CA 92631  
(209)252-9652

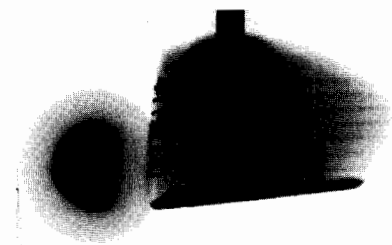
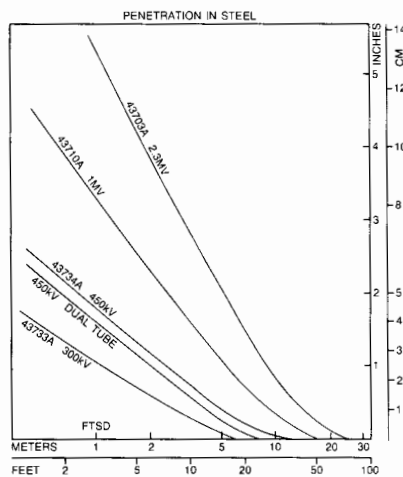
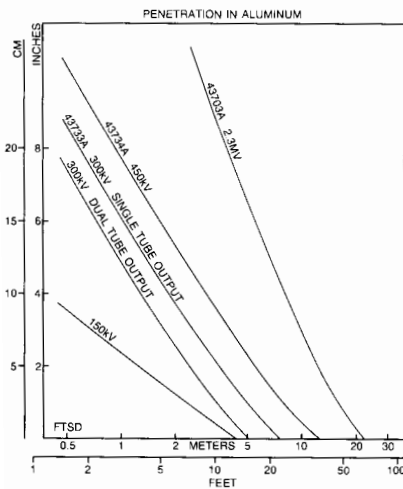

Compression of golf ball when hit with club

# CALCULATOR PRODUCTS

There is a better way to meet your computational needs: Hewlett-Packard calculators. Whether you need a scientific or business calculator, Hewlett-Packard offers a range of quality products designed to be the finest of their kind.

Scientific calculators featuring RPN are the new, expandable HP 48SX and the HP 28S, HP 42S, and HP 32S. The HP 21S and HP 20S have algebraic entry systems. Business calculators include the HP 19BII and HP 17BII with a choice of entry systems (HP's time-tested RPN or algebraic), the HP 12C with RPN, and HP 10B with algebraic.

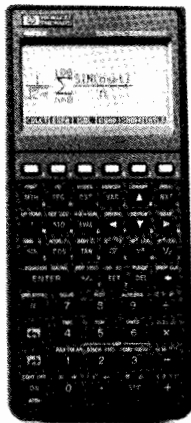

HP 48SX

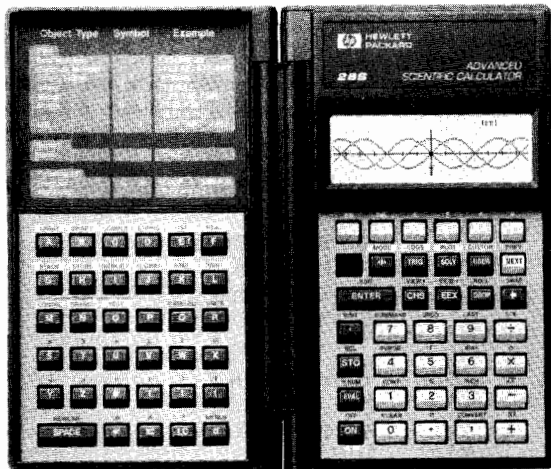

HP 28S

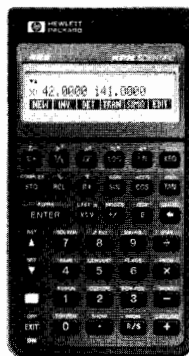

HP 42S

The HP Solve application, a standard feature on the HP 48SX, HP 28S, HP 42S, HP 32S, HP 19BII, and HP 17BII, lets you enter your own equations and solve for any variable to explore "what if" scenarios.

For hard-copy records of your calculations, an optional infrared printer is available for use with the HP 48SX, HP 28S, HP 42S, HP 19BII, and HP 17BII.

## Scientific Calculators

### HP 48SX expandable calculator

The HP 48SX is a major advancement. It is designed especially for engineering professionals, students, and educators. No other calculator comes close to matching the features of the new HP 48SX. With the HP EquationWriter application, you can enter equations just as they appear on paper. Graphics and calculus are combined like never before to find roots, intersections, local extremes or slopes, and derivatives while you view a graph of the equation. Easy unit management lets the HP 48SX keep track of the units as well as do the calculations for fast, accurate results. With the HP MatrixWriter application it is easy to enter and view large matrices. Symbolic math functions and the HP Solve application are standard. Expansion options allow you to increase your RAM, link to your DOS or Mac computer via RS-232C, and customize with specific plug-in application cards. The HP 48SX has a large 8-line, 22-character dot matrix display, RPN entry system, over 2100 built-in functions, 32 Kbytes of RAM (expandable to 288 Kbytes) and a two-way infrared interface to go to other HP 48SXs or a printer. Application cards are available.

### HP 28S advanced scientific calculator

The HP 28S was the first scientific calculator to offer symbolic solutions for technical professionals and students in math and engineering. It performs symbolic algebra and calculus computations, and it plots equations on its display. It has 32 Kbytes of RAM, memory management features for organizing information stored in memory, an advanced graphics package with graphics storage and recall, matrix, vector and complex-number arithmetic, and advanced programmability through a high-level programming language. Other features include menus and softkeys that make access to functions faster and easier, the HP Solve application for use in personalizing the HP 28S without programming, and enhanced RPN with optional algebraic entry. The HP 28S has a 4-line by 23-character alphanumeric display with separate keyboards for numbers and letters and a wireless infrared printer interface. Application books are available.

### HP 42S scientific calculator

The powerful HP 42S is an engineer's best tool for matrix math as well as an excellent replacement for the HP 15C. A sophisticated matrix editor prompts for input and makes it easy to solve problems such as simultaneous equations. Variables can be named, including real and complex numbers and matrices. A variable and function catalog keeps track of the names, and they can be accessed directly from the catalog by simply scrolling to the desired entry and executing it. The HP 42S also features the RPN HP Solve application and numerical integration. Custom menus can be created and assigned to the top row of keys. And it can run thousands of keystroke programs available for the HP 41C/CV. The HP 42S has a 2-line, 22-character dot-matrix alphanumeric display, RPN entry, 8 Kbytes of RAM, and an infrared printer interface. Application books are available.

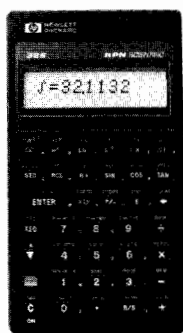

HP 32S

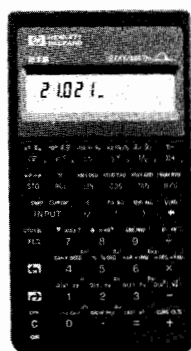

HP 21S

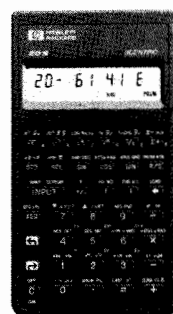

HP 20S

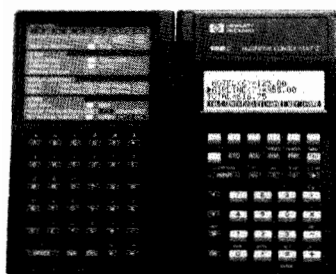

HP 19BII

#### HP 32S scientific calculator

The HP 32S gives technical professionals and students the RPN advantage at the lowest price. It is the perfect HP 11C replacement. It has a complete set of math and science functions, RPN HP Solve application - which solves for any variable without reprogramming, numerical integration, complex number functions, and keystroke programming for solving repetitive problems. Programming includes looping and test flags for problems that require logical decision making. The HP 32S has a one-line, 12-character dot-matrix display, RPN entry, 390 bytes of user RAM and 27 storage registers. An application book is available.

#### HP 21S stat/math calculator

The HP 21S is designed for college students in disciplines such as social sciences, agriculture, life sciences, psychology, and business, who are required to take statistics courses. The HP 21S eliminates the need for statistics tables, calculates common statistics distribution values and their inverses, and includes a statistical program library. Sample test statistics can be used to perform hypothesis testing and construct confidence intervals. In addition to its statistics functions, the HP 21S has all the essential math functions for college math classes plus time-value-of-money functions for business classes. The HP 21S has a one-line, 12-character numeric display and algebraic entry.

#### HP 20S scientific calculator

With the HP 20S, engineers, technicians, and students get an entry-level, algebraic machine with all the functions other scientific calculators in the same price range offer plus a library containing six of the most-used programs for math, science and engineering. The HP 20S program library provides root finder, numerical integration, complex-number operations, curve fitting, 3x3 matrix operations, and quadratic equation solutions. In addition to its program library, the HP 20S has keystroke programming with conditional tests, base-conversion and base-arithmetic operations. The HP 20S has a one-line, 12-character numeric display and algebraic entry.

#### Business Calculators

##### HP 19BII Business Consultant

The HP 19BII is the ultimate financial calculator and includes time-saving tools for daily organization. It gives you a choice of entry systems: RPN or algebraic. It combines the most comprehensive set of business and financial functions found in any calculator with an impressive set of information management features. Yet it is easy to use because of its menu and softkey approach to problem solving. The HP 19BII offers the HP Solve application, bond calculations, and a graphics package that plots histograms, scatter diagrams, curve fits, and NPV vs. discount rate for investment analysis. Information Management features include time and appointment functions, number lists that you can label and total, currency/unit measurement conversions, and the ability to store and manage name and address lists. The HP 19BII has a 4-line by 23-character alphanumeric display, separate keyboards for numbers and letters, 6,500 bytes of RAM and an infrared printer interface. Application books are available.

# CALCULATOR PRODUCTS

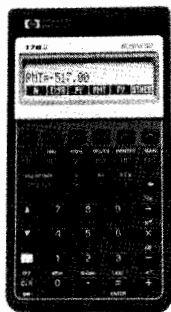

HP 17BII

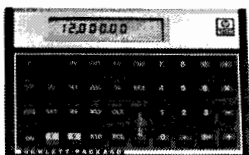

HP 12C

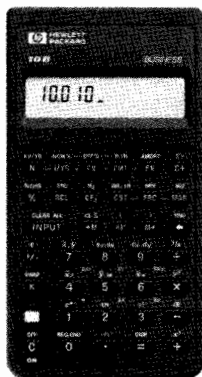

HP 10B

### HP 17BII financial calculator

The HP 17BII offers you everything the HP 12C has become famous for - and more. It is designed for use by real estate and financial professionals, and it is the only calculator in its class to offer more than 250 easy-to-use business functions: features like the HP Solve application, menus and softkeys, clock and alarm, list-based statistics, cash flows and powerful, SIA-standard bond calculations. Users have a choice of entry systems: HP's RPN or algebraic. The HP 17BII has a 2-line, 22-character alphanumeric display, 6,500 bytes of user RAM, and an infrared printer interface. Application books are available.

### HP 12C programmable financial calculator

The HP 12C is the proven performer for real estate and finance. It features business and financial functions for calculating mortgages, balloon payments, depreciation, and bond yield, plus math and statistics. The HP 12C has a one-line, 10-digit numeric display, RPN entry system and 20 storage registers. Application books are available.

### HP 10B business calculator

The HP 10B entry-level calculator has the essential business functions plus HP quality in an extremely easy-to-use form. An auto-increment feature makes amortization schedules quicker to generate. Label descriptors make it easy to understand and enter cash flows and to identify interest, principal, and remaining balance in an amortization schedule. There is no need to shift modes to access functions; all functions on the HP 10B are available all of the time. Because the HP 10B does not use a COMPUTE key, it saves time by eliminating keystrokes. The HP 10B has a one-line, 12-digit numeric display and algebraic entry.

### Ordering Information

	<b>Price</b>
HP 48SX Expandable Scientific Calculator (RPN)	\$350.00
HP 28S Advanced Scientific Calculator (RPN)	235.00
HP 42S Scientific Calculator (RPN)	120.00
HP 32S Scientific Calculator (RPN)	69.95
HP 21S Stat/Math Calculator (Algebraic)	49.95
HP 20S Scientific Calculator (Algebraic)	49.95
HP 19BII Business Consultant (RPN/Algebraic)	175.00
HP 17BII Financial Calculator (RPN/Algebraic)	110.00
HP 12C Programmable Financial Calculator (RPN)	94.95
HP 10B Business Calculator (Algebraic)	49.95

☎ For same-day shipment, call HP DIRECT at 800-538-8787

Prices shown are suggested U.S. List.

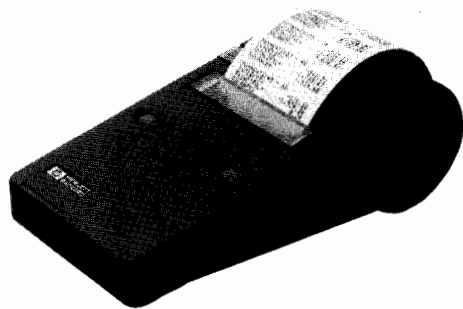

HP 82240B

### Enhancements And Peripherals

For use with HP 48SX, HP 28S, HP 42S, HP 19BII, HP 17BII

#### HP 82240B Infrared Printer

An infrared light beam provides a cordless connection to the calculator up to 18 inches away. The HP 82240B prints 24 characters per line in 5x8 dot matrix. This thermal printer turns itself off after 10 minutes of inactivity, has a power indicator and uses batteries or an optional AC adapter.

#### Ordering Information

HP 82240B Infrared Printer (110V)

Price  
\$135.00 ☎

HP 82241A Adapter, U.S. (110V)

15.00 ☎

#### Accessories

Accessories such as owner's manuals, battery packs, rechargers and software manuals are readily available for all types of HP calculators. To order, call your HP DIRECT office. In the U.S., call 800-538-8787.

#### Ordering Information

For use with HP 48SX

HP 82207A Serial Interface Kit

Price  
\$59.95 ☎

NEC Japan Only

Opt. 1AW Serial Interface Cable Only

-24.95 ☎

NEC Japan Only

HP 82208A Serial Interface Kit

59.95 ☎

IBM-compatible

Opt. 1AW Serial Interface Cable Only

-24.95 ☎

IBM-compatible

HP 82209A Serial Interface Kit

59.95 ☎

Apple/Macintosh

Opt. 1AW Serial Interface Cable Only

-24.95 ☎

Apple/Macintosh

HP 82210A HP 41CV Emulator Card

99.95 ☎

HP 82211A HP Solve Equation Library

99.95 ☎

Application Card

HP 82214A 32-Kbyte Battery-backed RAM Card

79.95 ☎

HP 82215A 128-Kbyte Battery-backed RAM Card

250.00 ☎

HP 82220A HP 48SX Overlay Kit

15.00 ☎

HP 82221A Soft Case for the HP 48SX

15.00 ☎

00048-90003 HP 48SX Owners Manual, English

25.00 ☎

00048-90054 HP 48SX Reference Manual

25.00 ☎

82211-90001 HP Solve Equation Library Application

10.00 ☎

Card Owner's Manual, English

☎ For same-day shipment, call HP DIRECT at 800-538-8787

### Application Books

#### HP 28

00028-90111 Mathematical Applications (HP 28S)	\$9.95 ☎
00028-90105 Vectors and Matrices (HP 28C/S)	9.95 ☎
00028-90101 Algebra and College Math (HP 28C/S)	9.95 ☎
00028-90102 Calculus (HP 28C/S)	9.95 ☎
00028-90104 Probability and Statistics (HP 28C/S)	9.95 ☎

#### HP 42S

00042-90020 Programming Examples and Techniques	\$9.95 ☎
00042-90021 Electrical Engineering	9.95 ☎
00042-90022 Mechanical Engineering	9.95 ☎

#### HP 32S

00032-90057 Engineering Applications	\$9.95 ☎
--------------------------------------	----------

#### HP 19 and HP 17

00017-90019 Real Estate, Banking and Leasing	\$9.95 ☎
00017-90020 Business Finance and Accounting	9.95 ☎
00017-90021 Marketing and Sales	9.95 ☎
00017-90022 Personal Investment and Tax Planning	9.95 ☎

#### HP 12C

00012-90015 Real Estate Applications	\$15.00 ☎
00012-90021 Leasing Applications	15.00 ☎
00012-90022 Training Guide	15.00 ☎

#### HP 41CV/CX

*Although the HP 41CV/CX calculators have been discontinued, the following items are still available:*

#### Peripherals

HP 82240B Infrared Printer (110V)	\$135.00 ☎
HP 82241A Adapter, U.S. (110V)	15.00 ☎
HP 82161A Digital Cassette Drive	250.00 ☎

#### Interfaces

HP 82164A HP-IL/RS-232 Interface	\$295.00 ☎
HP 82169A HP-IL/HP-IB Interface	395.00 ☎
HP 82242A Infrared Printer Interface Module Plug-in Module for HP 41CV/CX	65.00 ☎

#### Application Modules

00041-15005 Surveying	\$45.00 ☎
00041-15016 Real Estate	45.00 ☎
00041-15022 Games	45.00 ☎
00041-15049 Math/Statistics	45.00 ☎
00041-15055 HP 41 Advantage	49.00 ☎

For additional information or a demonstration of Hewlett-Packard calculators, check the yellow pages for your nearest dealer.

Prices shown are suggested U.S. List.

☎ For same-day shipments, call HP DIRECT at 800-538-8787

© 1987 Hewlett-Packard Company  
All rights reserved. Printed in the U.S.A.  
HP 82240B Infrared Printer  
Model 82240B  
Part Number 82240B-001  
1987-01-01

# NETWORKED COMPUTER SYSTEMS

## HP NewWave Office

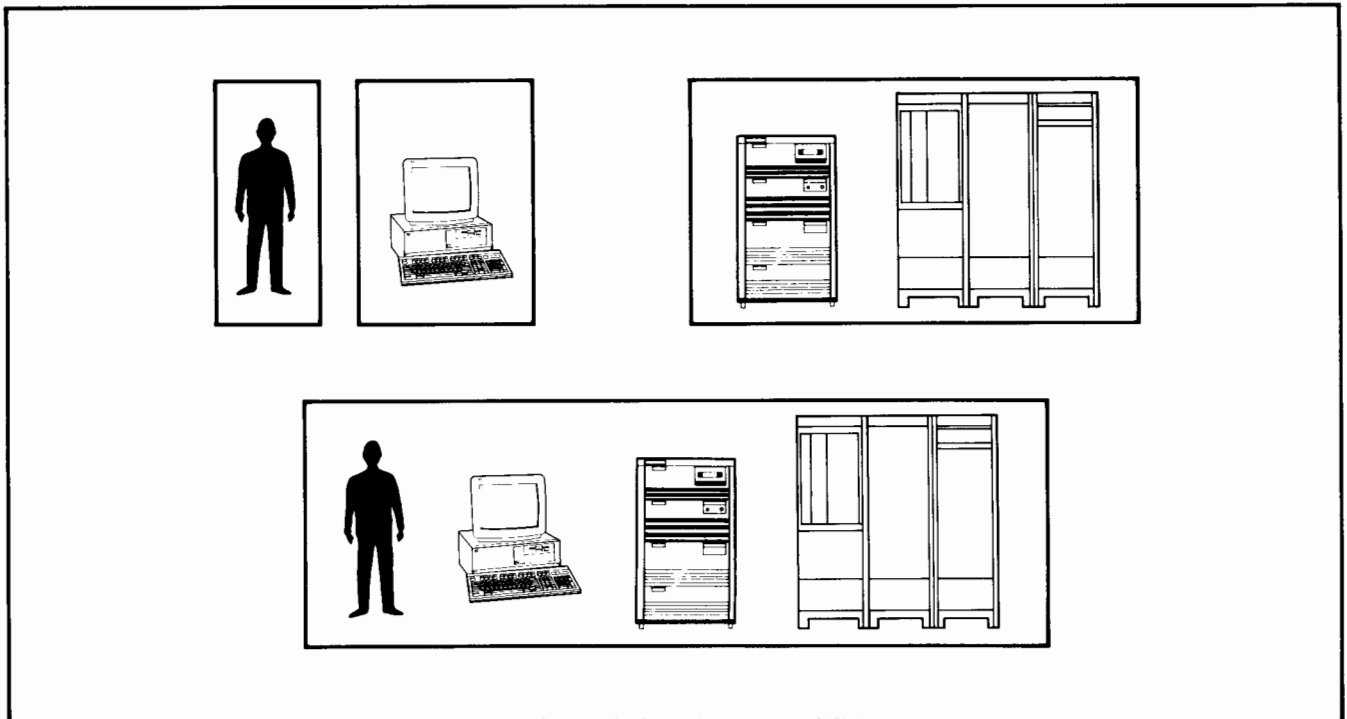

Hewlett-Packard integrates your company's information resources into a single, tightly knit information network.

### Better Use of Information and Computing Resources

By making information more useful and HP 3000/HP 9000 systems more effective, Hewlett-Packard's NewWave Office Software enhances your entire investment in information resources. The solutions combine products that utilize the advantages of personal computing, networking, and distributed data processing into one complete integrated system.

Furthermore, HP's NewWave Office is completely tied to your organization's application environment, providing immediate access to departmental, corporate and even global information resources. Users at all levels are better able to access, analyze, manipulate, share, and distribute vital information in order to make better, more timely decisions.

### The HP NewWave Environment

The HP NewWave environment is an advanced personal computer application environment providing a single window, or view, into your entire network of information and computing resources. This open environment is based on industry standards and is designed to allow the end user to focus on completing tasks rather than on learning and using individual applications. Furthermore, the HP NewWave environment presents a major opportunity for the developer to deliver greater benefits to customers.

Users working in the HP NewWave environment can move quickly and easily from one application to another because applications are integrated seamlessly. The Object Management Facility (OMF) allows end users to link, combine, or manipulate different forms of data such as text, spreadsheets, graphics, scanned images and voice by treating it as a single object; to the end user, these objects are represented as "icons." By manipulating the icons, a user can create compound objects by using the mouse to move one icon on top of another.

Once completed, these objects can be shared with other users in the organization.

In addition, the HP NewWave environment also provides the user with services such as computer-based training, context-sensitive help, and Agents. Agents are an intelligent facility which performs tasks on behalf of the user and operates throughout the environment, across application boundaries, to automate tasks. Tasks can be triggered without user interaction based on time or conditional events.

### HP NewWave Developer Products

There are three key products designed to enable developers to begin immediate design work on new applications or to integrate their current applications with the HP NewWave architecture: the Developer Kit, Developer Training and Technical Support.

### The HP NewWave Developer Kit

The HP NewWave Developer Kit contains all the HP components needed to write applications for this new environment. It includes the HP NewWave environment software, software development tools, and documentation.

### HP NewWave Developer Training

This is an invaluable course for software developers who will be writing applications under the HP NewWave environment. Although the HP NewWave environment is based upon Microsoft Windows, it consists of many extensions to Windows. This course provides the concepts and information on both Microsoft Windows and those extensions needed by any HP NewWave application developer.



# NETWORKED COMPUTER SYSTEMS

## HP NewWave Office (cont'd)

### NewWave Office: Leadership in PC Integration

PC integration and specific departmental services, such as access to information, system-wide communication, and shared resources, increase the effectiveness of workgroups by linking personal computers, terminals, minicomputers, mainframes and peripherals. Shared printers, plotters and disk storage maximize return on peripheral investments. Backing up PC hard disks to HP systems increases data security, and centralized distribution of PC applications increases MIS control.

Integrating PC resources with the HP 3000 or HP 9000 mini-computer concentrates the power of each computer on the tasks it performs best. For example, the HP 3000 is designed for transaction-based processing and the PC is designed to enhance individual productivity.

HP's NewWave Office incorporates these PC integration and departmental service capabilities into a centrally managed system. NewWave Office enhances the HP 3000 or HP 9000 environment with resource sharing, information access, information distribution and popular PC applications capabilities. For example, with HP NewWave Office, users can extract data from HP 3000 applications, analyze and describe the information on their PC, and distribute the results electronically throughout the organization. The result: significantly improved use of computer resources and more timely, accurate decision making.

Specific features of HP NewWave Office include:

- PC Backup
- Information Distribution
- Printer and Plotter Sharing
- Disk Sharing
- Centralized PC Software Distribution
- Access to Information
- Networked PC Management
- Advanced PC Applications

In addition, customers who do not need the complete capabilities of NewWave Office can purchase the departmental services of information access and information distribution, as well as PC application components individually.

### NewWave Office Components Information Access

Information Access is a unique information management software package that provides access to information, facilitates reporting and data exchange, and coordinates distribution between personal computers, HP 3000 or HP 9000 minicomputers. It is an information server that extends the reach of your data processing systems by delivering key business data throughout your organization. Information Access provides the means for end users to make better-informed decisions based on up-to-the-minute information by providing simple, yet secure, access to information wherever it resides.

Information Access provides the most current information to PC users by allowing access to local and remote HP 3000 and HP 9000 systems as well as PC databases. Results can be output directly to many popular PC applications, including Lotus 1-2-3. Additionally, MIS professionals are no longer burdened by requests for custom reports because end users have direct access to the crucial information they require.

### Information Distribution

HP DeskManager for the HP 3000, and HP Open Mail for the HP 9000 manages the flow of information throughout your network via electronic mail, and lets you integrate data processing applications such as for finance, payroll and order processing functions. It simplifies administration of the electronic mail system with central directory keeping, and provides security features such as password protection, access limitation, and message scrambling.

All types of messages, programs and data files, can be sent and received down the hall or around the world. The HP NewWave Office information distribution services facilitate enterprise-wide communication. It offers users access to X.400-based mailing services, other UNIX mailing products, as well as connectivity to IBM's PROFS and DISOSS. Now you can link mail systems so that everyone in your company can exchange information with each other better, resulting in improved interorganizational communication and a faster response time.

### Additional Departmental Services Products

The following products augment the standard departmental services with advanced capabilities to further enhance the effectiveness of workgroups, departments or entire companies. These products can be added to systems that already have NewWave Office or its individual components on their HP 3000 systems.

#### HP File/Library

HP File/Library is a complete electronic filing solution for the entire department. Any file, even a paper file, can be indexed in the HP File/Library catalog. Users can access documents wherever they are located, thus eliminating the need to duplicate files in multiple locations and saving valuable disk space by archiving documents onto inexpensive cartridge or tape.

#### HP Schedule

HP Schedule keeps track of schedules and coordinates the busy calendars of an entire department or even a group of departments. It sets up meetings and can schedule resources located anywhere on the network — from conference rooms and audio-visual equipment to corporate jets.

#### PROFS (MPE/V Systems Only)

HP OfficeConnect to PROFS provides a transparent electronic mail link between HP systems running DeskManager and IBM's Professional Office System, allowing users of these two systems to communicate with each other through their own electronic mail systems.

#### DISOSS (MPE/V Systems Only)

HP OfficeConnect to DISOSS provides a transparent electronic mail link between these two systems and IBM's Distributed Office Support System. Users on either system can communicate with each other using their standard address formats. Also, users on both systems have open access to distribution lists and DISOSS document libraries.

#### CONVERT/DCA

HP Convert/DCA enables HP and IBM users to exchange and edit documents in both Final and Revisable Form Text DCA (Document Content Architecture). IBM PC users with DisplayWrite can exchange revisable documents with HP Vectra PC users using AdvanceWrite and Executive MemoMaker software.





# PERSONAL COMPUTERS & TERMINALS

## Overview and Matrix



The HP Vectra PC family offers high performance at every price level to meet your individual needs.

### Products for Every Need

Hewlett-Packard's PC and terminal product lines offer a broad range of excellent price/performance choices to meet a wide variety of needs, from entry-level ASCII terminals to advanced i486-based PCs.

The HP Vectra 486 PC is a high-performance product for the most demanding applications. This EISA (Extended Industry Standard Architecture) - based PC is ideal as a LAN server, multiuser host, CAD station, or other power user workstation. The HP Vectra 486 PC supports up to 64 Mbytes of RAM, 1.3 Gbytes of mass storage capacity, and is designed to handle any of your single or multiuser applications. This PC performs at levels previously reserved only for mini-computers.

The HP Vectra RS/25C PC provides exceptional power and expansion capabilities, and is suited for business, engineering, or scientific applications by using the full power of the 32-bit Intel 386 microprocessor.

The HP Vectra QS/16S, QS/20, and 386/25 PCs apply state-of-the-art technology to deliver the speed and power you need for sophisticated office applications. These 386-based machines are ideal for running applications such as desktop publishing, large databases, and complex spreadsheets, as well as PC-based CAD.

As a stand-alone desktop unit or as a component of a networked system, the HP Vectra 286/12 PC is designed to meet the ongoing challenges of your office environment. Operating at 12-MHz, this 286-based machine

improves productivity as it speeds through almost any aspect of business, from accounting to project management, desktop publishing to business graphics. All HP Vectra PCs are fully compatible with the PC/AT ISA Industry-Standard Architecture and run popular operating systems such as MS-DOS®, OS/2, and, SCO™ XENIX. Hewlett-Packard's commitment to industry standards ensures a smooth growth path to next-generation operating systems and applications.

If your computing environment requires terminals, Hewlett-Packard has a complete line for all your system needs within HP, DEC, and other system environments. These products are designed with state-of-the-art ergonomics, including keyboards with tactile feedback, tilt and swivel displays, and a choice of phosphor colors.

Hewlett-Packard's graphics subsystems meet the graphics-intensive demands of CAD applications. The 16- and 20-inch high-resolution displays deliver unequalled display quality. The multiscanning display technology allows you to readily switch between CAD applications, which take advantage of high-resolution graphics cards, and office applications, which use a VGA card. This wide range of resolution support (VGA through 1280 by 1024) provides extensive flexibility and growth, and protects your display investment. For users who only require VGA resolution, the HP industry-standard solution provides display performance up to three times faster than others available.

### HP Personal Computers

Hewlett-Packard has a personal computer

system to match any application need. From the midrange 286-based PCs to the top-of-the-line i486-based systems, HP Vectra PCs excel in their class.

#### HP Vectra 286/12 PC

- 12-MHz, 286-based desktop PC
- Up to 8 Mbytes of 16-bit memory
- 4 available I/O slots (ISA)
- 3 half-height mass storage shelves

#### HP Vectra QS/16S, QS/20, and 386/25 PCs

- 16-, 20-, or 25-MHz, 386-based desktop PCs
- Up to 32 Mbytes of 32-bit memory
- 7 I/O slots
- 3 half-height mass storage shelves support up to 168 Mbytes of storage

#### HP Vectra RS/25C PC

- 25-MHz, 32-bit, 386-based deskside PC
- Cache memory architecture
- Up to 16 Mbytes of 32-bit memory
- 8 I/O slots
- 6 half-height mass storage shelves support up to 620 Mbyte of storage

#### HP Vectra 486 PC

- 25-MHz, 32-bit, i486-based processor with integrated coprocessor
- EISA-based, 32-bit I/O bus
- Up to 64 Mbytes of high-speed system memory
- 8 EISA accessory slots (ISA compatible)
- 6 half-height mass storage shelves

MS-DOS® is a U.S. registered trademark of Microsoft Corporation.

SCO™ is a trademark of Santa Cruz Operation, Inc.

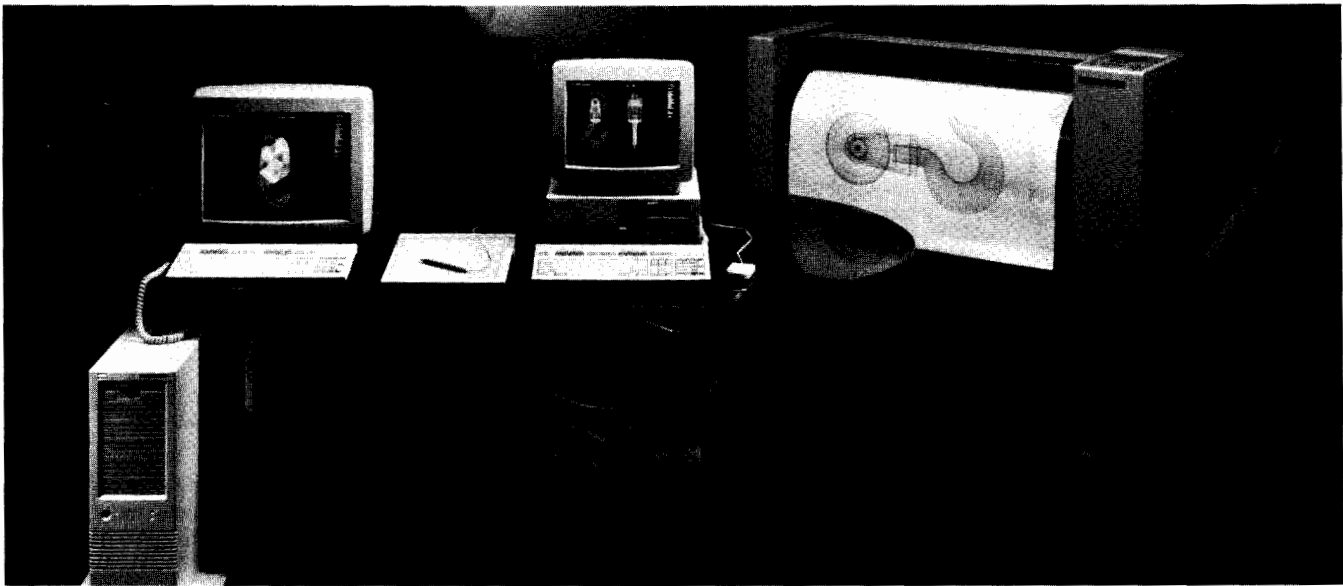

Hewlett-Packard's PC-based CAD products deliver the performance, reliability and full industry-standard compatibility you need for demanding CAD applications.

### Personal Computer Matrix

HP Vectra PC	Model number <sup>1,2</sup>	Product number	Processor	Standard Memory	Package type <sup>3</sup>	Flexible disk size (Mbyte)	Hard disk (Mbyte)	Video adapter	Price
286/12	Model 1	D2460A	80286 (12 MHz)	1 Mbyte	DT	5.25-in (1.2)	None	Super VGA	\$1,999.00
	Model 1	D2467A		1 Mbyte	DT	3.5-in (1.44)	None	Super VGA	\$1,999.00
	Model 20	D2461A		1 Mbyte	DT	5.25-in (1.2)	20	Super VGA	\$2,499.00
	Model 20	D2462A		1 Mbyte	DT	3.5-in (1.44)	20	Super VGA	\$2,499.00
	Model 40	D2463A		1 Mbyte	DT	5.25-in (1.2)	42	Super VGA	\$2,699.00
	Model 40	D2464A		1 Mbyte	DT	3.5-in (1.44)	42	Super VGA	\$2,699.00
QS/16S	Model 1	D1481B	80386SX (16 MHz)	1 Mbyte	DT	5.25-in (1.2)	None	None	\$2,399.00
	Model 1	D1461A		1 Mbyte	DT	3.5-in (1.44)	None	None	\$2,399.00
	Model 46	D1462B		1 Mbyte	DT	5.25-in (1.2)	42	VGA	\$3,499.00
	Model 47	D1464B		1 Mbyte	DT	3.5-in (1.44)	42	VGA	\$3,499.00
	Model 86	D1488B		1 Mbyte	DT	5.25-in (1.2)	84	VGA	\$3,999.00
	Model 87	D1489B		1 Mbyte	DT	3.5-in (1.44)	84	VGA	\$3,999.00
QS/20	Model 1	D1491B	80386 (20 MHz)	1 Mbyte	DT	5.25-in (1.2)	None	None	\$3,199.00
	Model 1	D1421B		1 Mbyte	DT	3.5-in (1.44)	None	None	\$3,199.00
	Model 46	D1422B		1 Mbyte	DT	5.25-in (1.2)	42	VGA	\$4,299.00
	Model 47	D1424B		1 Mbyte	DT	3.5-in (1.44)	42	VGA	\$4,299.00
	Model 86	D1498B		1 Mbyte	DT	5.25-in (1.2)	84	VGA	\$4,899.00
	Model 87	D1499B		1 Mbyte	DT	3.5-in (1.44)	84	VGA	\$4,899.00
386/25	Model 1	D2360A	80386 (25 MHz)	2 Mbytes	DT	5.25-in (1.2)	None*	Super VGA	\$5,399.00
	Model 1	D2371A		2 Mbytes	DT	3.5-in (1.44)	None*	Super VGA	\$5,399.00
	Model 80	D2363A		2 Mbytes	DT	5.25-in (1.2)	84	Super VGA	\$6,999.00
	Model 80	D2361A		2 Mbytes	DT	3.25-in (1.44)	84	Super VGA	\$6,999.00
	Model 170	TBD		2 Mbytes	DT	5.25-in (1.2)	168	Super VGA	\$7,999.00
	Model 170	TBD		2 Mbytes	DT	3.5-in (1.44)	168	Super VGA	\$7,999.00
RS/25C	Model 10e	D2021A	80386 (25 MHz)	1 Mbyte	DS	5.25-in (1.2)	None	None	\$6,299.00
	Model 100e	D2022A		1 Mbyte	DS	5.25-in (1.2)	103	None	\$8,099.00
	Model 150e	D2023A		1 Mbyte	DS	5.25-in (1.2)	155	None	\$9,799.00
	Model 154e	D2024A		4 Mbyte	DS	5.25-in (1.2)	155	None	\$9,499.00
	Model 304e	D2025A		4 Mbyte	DS	5.25-in (1.2)	310	None	\$11,699.00
	Vectra 486	Model 1		D2220A	80486 (25 MHz)	2 Mbytes	DS	5.25-in (1.2)	None
Model 150		D2221A	2 Mbytes	DS		5.25-in (1.2)	152	None	\$11,399.00
Model 330		D2222A	2 Mbytes	DS		5.25-in (1.2)	330	None	\$13,099.00
Model 670		D2223A	2 Mbytes	DS		5.25-in (1.2)	670	None	\$14,899.00

\* Available Summer 1990.

<sup>1</sup> A language option must be specified when ordering an HP Vectra PC (that is, option ABA for U.S. English).

<sup>2</sup> "e" denotes models with ESDI hard disk controller.

<sup>3</sup> DT = Desktop DS = Deskside

# PERSONAL COMPUTERS & TERMINALS

## Displays, Monitors and Accessories

HP D1181, D1182A, D1187A, D1188A, D2382A, A1086A, A1083A

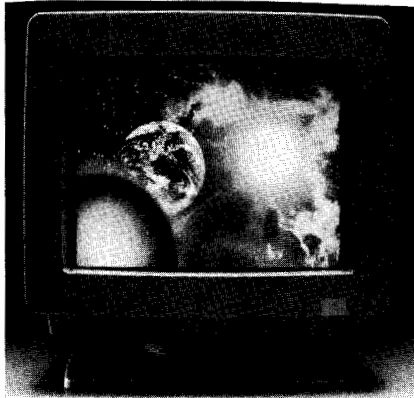

The D1182A Color VGA Display is a 14-inch, medium-resolution monitor that offers excellent graphics display and very high quality text character formation.

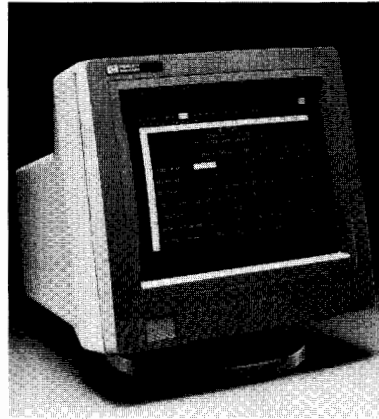

The D1181 A/G/W Monochrome VGA Display is a 14-inch, medium-resolution monitor that offers the user 640 x 480 graphics, 64 shades of gray and a choice of amber, green, or white phosphor.



The 20" D1187A and 16" D1188A High Resolution Monitors are multiscanning displays with superior display quality.



### HP D2382A Super Video Graphics Adapter Board

The HP Super Video Graphics Adapter Board (D2382A) helps to improve productivity by increasing the speed of all graphics and text applications. The HP Super VGA Board supports the standard VGA resolution of 640 x 480 graphics pixels or 80 x 25 text characters, and is backward compatible with CGA, Hercules, and EGA. It is capable of working in either 8-bit mode or 16-bit mode. Moreover, it supports extended modes of 800 x 600 (non-interlaced) with up to 16 colors and 1024 x 768 (interlaced) with up to 16 colors. The HP Super VGA Board offers users additional functionality over that available from VGA only boards.

The HP Super VGA Board is fully compatible with the HP Video Graphics Color Display, the HP Monochrome Video Graphics Display, the 16" and 20" High Resolution Color displays, and other monitors compatible with IBM's VGA video interface.

### HP D1181A/G/W Monochrome Video Graphics Display

The HP Monochrome Video Graphics Display (HP D1181A/G/W) is specifically designed for use with the HP Vectra PC family. It is plug-compatible with the industry-standard VGA monochrome monitors. HP's Monochrome Video Graphics Display is designed for use with the HP Super VGA Board (D2382A).

The Monochrome Display offers a choice of screen colors, including amber, green, and soft-white. The display supports resolutions, varying from 320 x 200 to 640 x 480 and can display up to 64 shades of gray. It is ideal for text, graphics, and image applications.

### HP D1182A Color Video Graphics Display

The HP Color Video Graphics Display (D1182A) is a 14-inch, medium-resolution color display. It is designed for use by business professionals or by low-end CAD users. The high quality of the screen and the fine resolution of the display tube are ideal for use in environments requiring a high daily system utilization. This combination provides both excellent graphics (in resolutions up to 640 x 480) and very high quality text character formation.

The D1182A display offers an optional tilt/swivel mechanism (PN 82959S) for enhancing ease of use.

### HP A1086A/A1083A High-Resolution Intelligent Graphics Controller 10 and 20

The Intelligent Graphics Controller 10 (A1086A) is five times faster than conventional VGA controllers, and supports resolutions up to

1024 x 768 with 16 or 256 colors in non-interlaced mode. The Intelligent Graphics Controller 20 (A1083A) is 15 times faster than conventional VGA controllers, and supports resolutions up to 1280 x 1024 with 16 or 256 colors in non-interlaced mode.

The IGC 10 and IGC 20 are designed for use in ISA (Industry Standard Architecture) PCs and support the TIGA-340 and DGIS interface standards. Both cards are upgradable via the addition of user-installed memory and permit VGA "pass-through."

The IGC 10 and IGC 20 are fully compatible with the 16" and 20" High Resolution Color displays.

### HP D1187A/D1188A High Resolution Monitors

The High Resolution Monitors (D1187A, 20" and D1188A, 16") provide superior display performance for personal computer and high-performance workstation users who need large screen and/or high resolution displays for various applications including: CAD, DTP, or windowing environments.

Through the use of multiscanning (multiple resolution) capability, both monitors work with a wide variety of video adapters providing video resolutions from VGA (640X480) through 1280X1024. In addition, automatic synchronization allows the displays to automatically sense and synchronize on resolutions pre-programmed into the digital, microprocessor controlled memory.

For convenience and ease of access, digital controls that provide repeatability and accuracy of adjustments are located on the front panel; plus each display offers an optional tilt and swivel base (D1189A, D1190A) which gives the user control of the display's viewing angle, and allows adjustment for room lighting.

### Ordering Information

	Price
HP D2382A Super VGA Board	\$399
HP D2383A 256K Memory Upgrade for Super VGA Board	\$159
HP A1083A Intelligent Graphics Controller 20	\$2,499
HP A1084A VRAM Kit (.5 MB)	\$400
HP A1085A DRAM Kit (.5 MB)	\$225
HP A1086A Intelligent Graphics Controller 10	\$995
HP A1087A Extension Module for HP A1086A	\$200
HP D1181A/G/W VGA Monochrome Display (amber, green, white)	\$349
HP D1182A/ABA VGA Color Monitor	\$749
HP D1187A/ABA 20-in High Resolution Monitor	\$3,695
HP D1188A/ABA 16-in High Resolution Monitor	\$2,795



# COMPUTER PERIPHERALS

## Secondary Storage

HP Series 6300, Series 6400, 9144A, 9145A, 7980XC, 7980A, 7979A

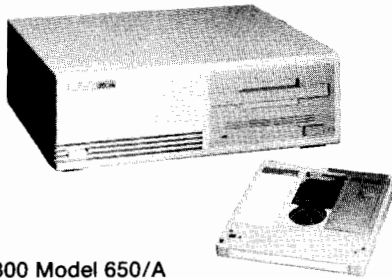

HP Series 6300 Model 650/A

### Rewritable Optical Disk Drive and Library System Direct Access Secondary Storage

Hewlett-Packard's rewritable optical storage products fill the gap between high-performance hard disks and low-cost tape storage. This is the perfect storage solution for applications that consume large portions of expensive hard disk space but require online access. The optical drive and library system are slightly slower than hard disk drives but more convenient than tape storage because they provide online access and do not require operator assistance.

#### ANSI/ISO Standards

In keeping with industry standards, HP's optical storage products implement SCSI and ANSI-ISO specified continuous composite recording format.

#### Durable, Removable media

HP's rewritable optical storage products feature reusable media that is compact and removable, simplifying storage and transport. Because the data resides on the disk's inner recording layer, it is not easily damaged. Data is not susceptible to head crashes, most magnetic interference, or damage from common office mishandling. The media accepts unlimited read-write passes without disk degradation and can be stored for at least 10 years. The 5.25-inch disk cartridge slips easily into a briefcase for transport or into a safe for security. Each rewritable disk can store up to 650 megabytes, 325 on each side.

#### Rewritable Optical Disk Drive

The HP Series 6300 Model 650/A is a standalone rewritable optical disk drive. It accommodates one 650-megabyte disk cartridge, with 325 megabytes are accessible on one side. The media must be ejected and flipped to access the other 325 megabytes. Storage is scalable with the addition of media. See product brief #5959-9906 for further information.

#### Rewritable Optical Library System

The HP Series 6300 Model 20GB/A provides up to 20.8 gigabytes of unattended direct access storage on 32 rewritable optical disks. A highly reliable autochanger delivers the 650-megabyte disk cartridges to two rewritable optical drives, allowing unattended direct access to previously operator-intensive offline data. See product brief #5952-0328 for more information.

#### Ordering Information

	<b>Price</b>
<b>HP C1701A</b> HP Series 6300 Model 650/A Rewritable optical disk drive (includes 1 rewritable optical disk cartridge)	\$6,435
<b>HP C1700A</b> HP Series 6300 Model 20GB/A Rewritable optical library system (includes 32 rewritable optical disk cartridges)	\$42,000

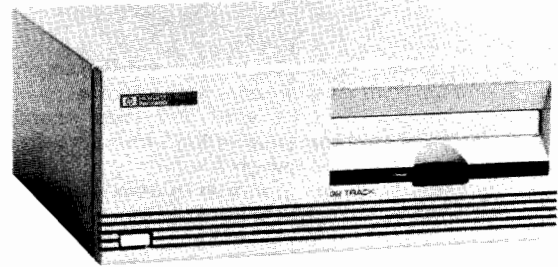

HP 9145A

### 1/4-inch Cartridge Tape Solution

The HP 9144A is a low-cost solution for technical systems, HP-UX Series 300 and small business systems, providing 67 megabytes of data storage on each 16-track cartridge tape.

The HP 9145A is a higher performance 1/4-inch cartridge tape drive for technical and small business systems. The HP 9145A has a transfer rate of 4 megabytes per minute (twice that of the HP 9144A) and stores 133 megabytes of data per cartridge tape. The HP 9145A reads and writes to 32-track cartridge tapes, and it will also read 160 track cartridge tapes.

#### Ordering Information

	<b>Price</b>
<b>HP 9144A</b> 1/4-inch cartridge tape drive (16-track)	\$2600
<b>HP 9145A</b> 1/4-inch cartridge tape drive (32-track)	\$4055

### Digital Audio Tape (DAT) Backup Solution

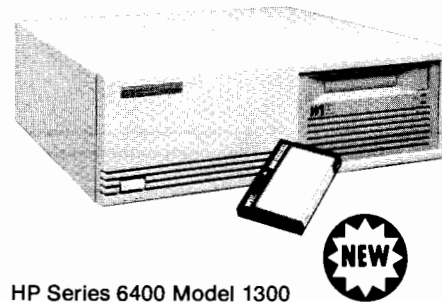

HP Series 6400 Model 1300

The HP Series 6400 Model 1300H and 1300S digital data storage (DDS) format tape drives are based on digital audio tape (DAT) technology. They provide 1.3 gigabytes of data storage on a single cassette and have a transfer rate of 11 megabytes per minute. The model 1300H has an HP-IB interface and the 1300S has a SCSI interface. The tape drives provide high-capacity, unattended backup for HP's commercial and technical systems.

#### Ordering Information

	<b>Price</b>
<b>HP C1511A</b> Series 6400 Model 1300H DDS-format tape drives (HP-IB)	\$7500
<b>HP C1512A</b> Series 6400 Model 1300S DDS-format tape drives (SCSI)	\$5700

### 1/2-Inch Tape Backup Solution

HP also offers high-performance streaming 1/2-inch tape drives, the HP 7980XC, 7980A, and 7979A. See technical data sheet #5953-6897 for details.

# COMPUTER PERIPHERALS

## Tablet—A-size Graphics Tablet

HP SketchPro, RS-232-C Model

687

- New technology for unparalleled reliability
- Includes stylus and four-button cursor
- Supported by major PC CAD software on the HP Vectra PC, IBM AT, IBM PC/XT, and compatibles

- Competitive Price
- Compact design with overlay hold-down/protector
- Superior resolution - up to 1200 lines per inch
- Multifunction softkeys with Mouse Mode

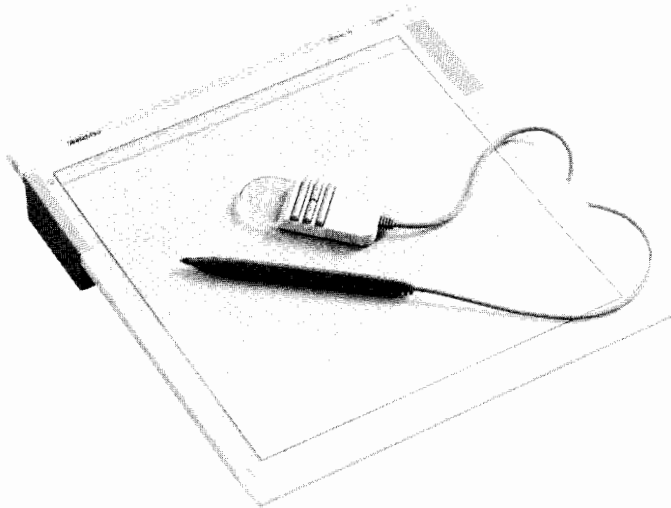

The HP 7060A SketchPro Graphics Tablet is a small format (11 x 11 in.) tablet for personal CAD systems. It is used for quick menu selection, and rapid cursor movements, as well as tracing and drawing. Primary applications include mechanical, electrical, and electronics CAD, and AEC (Architecture/Engineering/Construction). Secondary applications include business graphics and desktop publishing (DTP).

### Unparalleled Reliability

Due to a patent-pending Permuted Trace Ordering (PTO) technology, Hewlett-Packard can minimize parts, making the HP SketchPro tablet one of the most reliable tablets on the market. The SketchPro tablet meets HP's standards, at a low price.

### Supports Top PC CAD Packages

The HP SketchPro tablet is designed to work with the software and hardware you have selected. The HP SketchPro tablet's industry-standard RS-232-C/CCITT V.24 interface enables users to connect the SketchPro tablet to the HP Vectra PC, IBM AT, IBM PC/XT, and compatibles.

The HP SketchPro tablet has four operating modes: Hewlett-Packard, Summagraphics Bit Pad 2 (emulation), Hitachi HDG1111B (emulation), and Microsoft Mouse (emulation). With these modes, the SketchPro tablet supports the most popular CAD and graphics software, such as AutoCAD, VersaCAD, and CADKEY.

### A Complete Package

The HP SketchPro tablet provides everything you need in the box - For operation, both a comfortable stylus and four-button cursor; for interfacing, an RS-232-C/CCITT V.24 cable for the HP Vectra PC or the IBM AT and compatibles, a cable adapter for the IBM PC/XT and compatibles, and set-up instructions for configuring your software; for tablet menus, a clear anti-static overlay to hold menus securely in place without tape.

### Intelligent Design

The HP SketchPro has been designed with special attention to ergonomics and aesthetics. The tablet's slope and shape provide maximum user comfort. The anti-static overlay and recessed menu area mean menus without messy tape. Plus the small footprint saves valuable desk space. Both a power on/off LED and a point-digitizing LED provide positive feedback.

### Superior Resolution

The HP SketchPro tablet has a resolution that is programmatically selectable up to 480 lines per cm (1219 lines per in.), and is accurate up to within 0.5 mm (0.02 in.) of the selected point. The HP SketchPro tablet's resolution meets the most stringent requirements.

### Multifunction Softkeys

The HP SketchPro tablet includes several softkeys to provide commonly used functions; variable active areas, aspect ratio adjustments, and mouse mode. These softkeys are predefined. Additional, programmable softkeys are provided for future software vendor support.

### Specifications

**Size:** height, 50 mm (2.0 in.); width, 325 mm (12.8 in.); depth, 343 mm (13.5 in.); tablet tilt, 7 degrees

**Net weight:** 1.8 kg (4 lbs)

**Power requirements:** source, 110-120 V or 230-240 V (depending on country); frequency, 60 Hz or 50 Hz (depending on country); power, 4.1 Watts

**Resolution:** 480 lines per cm (1219.05 lines per in.)

**Accuracy:**  $\pm 0.5$  mm (0.02 in.); repeatability,  $\pm 0.25$  mm (0.01 in.)

**Proximity:** 2.5 mm (0.01 in.); jitter, 0 pixels

**Stylus tilt:** any degree  $< 90^\circ$

**Active area:** 278 mm x 278 mm (11 in. x 11 in.)

**Technology:** capacitive with Permuted Trace Ordering (PTO)

**Data output rate:** up to 120 pairs per second

**Baud rate:** up to 92,000 baud

**Product regulations:** safety, UL Listed, CSA certified; RFI, tested at system level to FCC class B and VDE level B; Acoustics, less than 40 db sound per A-weighted scale

**Environmental range:** operating temperature,  $0^\circ$  to  $55^\circ$  C; non-operating,  $-40^\circ$  to  $70^\circ$  C; operating relative humidity, 5% to 95%; shock,  $\frac{1}{2}$  sine shock pulse  $< 3$  msec duration, 160 in./sec delta V, non-operating Trapezoidal pulse, 30 g, 292 in./sec delta V

### Ordering Information

HP 7060A HP SketchPro Graphics Tablet

**Price**  
**\$599**

AutoCAD is a trademark of Autodesk, Inc. and Microsoft is a registered trademark of Microsoft Corporation.

# COMPUTER PERIPHERALS

## Tablets — A-size Graphics Tablet

HP 45911C, HP-HIL Model

- Low cost
- Works with HP Vectra, Touchscreen, and HP 9000 Series 300 systems
- High-resolution: up to 1200 lines/inch
- Easy connection using HP-HIL

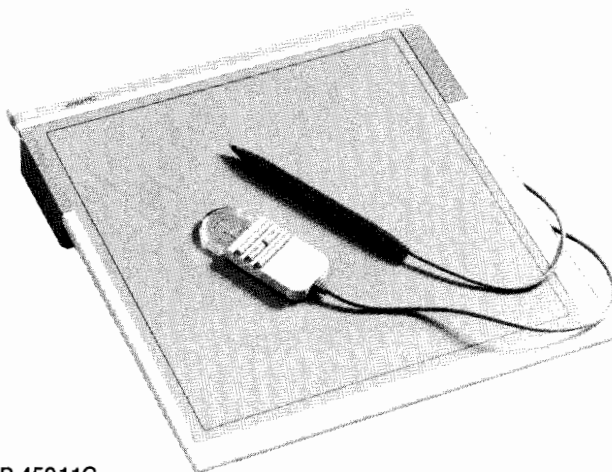

HP 45911C

The HP 45911C is a high-performance, low-cost graphics tablet. When it is installed on a computer supporting the Hewlett-Packard Human Interface Link (HP-HIL), you have a very effective pointing device to increase your productivity with interactive graphics applications such as mechanical, electrical, and electronics CAD, AEC (architecture/engineering/construction), business graphics, and desktop publishing (DTP).

The HP Graphics tablet is ideal for tasks such as menu picks, graphics placement, drawing, and tracing. Overlays, like the ones provided with many software packages, can be used on the tablet allowing you to choose menu items conveniently without using screen space. With the tablet's stylus you can make fast movements and create complex drawings as easily as with a pencil and paper.

### Unparalleled Reliability

Due to a patent-pending new Permuted Trace Ordering (PTO) technology, Hewlett-Packard can minimize parts, making the HP 45911C one of the most reliable tablets on the market. The tablet meets the reliability standards you expect from Hewlett-Packard, at a low price.

### Excellent Performance

The HP Graphics tablet has very high resolution, up to 1200 lines per inch. And its fast response time and high accuracy make it easy to use. The tablet is based on capacitive technology and is immune to the effects of magnetic fields.

### Easy to Install and Use

The stylus is as easy to use as a pencil. Movements of the stylus tip on the tablet surface will be tracked on the computer monitor. The stylus tip can be activated by a gentle push of its tip onto the tablet surface.

The HP Graphics tablet can be used with computers and applications which support the HP-HIL interface. HP-HIL allows you to daisy chain up to 7 input devices (such as a mouse, tablet, bar code reader, keyboard, and others) without using a serial port. Simply plug the HP Graphics tablet into the keyboard, HP-HIL port, or another input device. The HP-HIL interface provides power from the host computer or terminal, eliminating the need for additional power cords.

### Saves a Serial Port

Since HP-HIL input devices have their own port and they daisy chain together, your serial ports are free so you can use other peripherals, such as plotters and printers. If you want to use input devices and output devices at the same time, you won't need multiple serial port cards or costly switch boxes.

### Software Support

The HP Graphics tablet is supported by many popular software packages including ME 10, Graphics Gallery, AutoCAD™ (version 2.52 and above), and Versacad (version 5.1 and above).

### Superb Design

The HP Graphics tablet has been designed with special attention to ergonomics and aesthetics. The tablet slope and stylus shape have been chosen to make it comfortable in use. And the tablet is so compact in size it uses less desk space than most tablets with equivalent active area.

### Specifications

**Size:** height, 50 mm (2.0 in.); width, 325 mm (12.8 in.); depth, 343 mm (13.5 in.)

**Active area:** 278 mm x 278 mm (11 in. x 11 in.)

**Tablet tilt:** 7 degrees

**Net Weight:** 1.8 kg (4 lbs)

**Power requirements:** voltage, 12 Vdc (supplied by HP-HIL); current 200 mA maximum; power, 2.4 Watts

**Resolution:** 480 lines per cm (1219.05 lines per in.)

**Accuracy:** ±0.5 mm (.02 in.)

**Repeatability:** ±0.25 mm (.01 in.)

**Proximity:** 2.5 mm (.1 in.)

**Stylus tilt:** any angle <90°

**Data output rate:** up to 120 pairs per second

**Document material:** non-conductive

**Product regulations:** safety, UL Listed, CSA certified; RFI, tested at system level to FCC class B and VDE level B; Acoustics, less than 4.0 db sound per A-weighted scale

**Environmental range:** operating temperature, 0° to 50° C; non-operating, -40° to 70° C; operating relative humidity, 6% to 95%; shock, ½ sine shock pulse <3 msec duration, 160 in./sec delta V, non-operating Trapezoidal pulse, 30 G, 292 in./sec delta V

### Accessories Supplied

**Stylus:** 16 cm with .75 m attached cable

**Cursor:** 4 button with .75 m Cable

**Overlay Protector:** 295 mm x 295 mm (11½ in. x 11½ in.)

HP-HIL Cable

### Ordering Information

HP 45911C Graphics Tablet  
AutoCAD is a trademark of Autodesk, Inc.

**Price**  
\$599



# COMPUTER PERIPHERALS

## Printers — Color Graphics

HP 3630A, C1602A, C1613A

689

- Eight standard colors and up to 16.7 million shades and hues
- Near-letter-quality text; 167 characters per second at 10 pitch
- One-year warranty

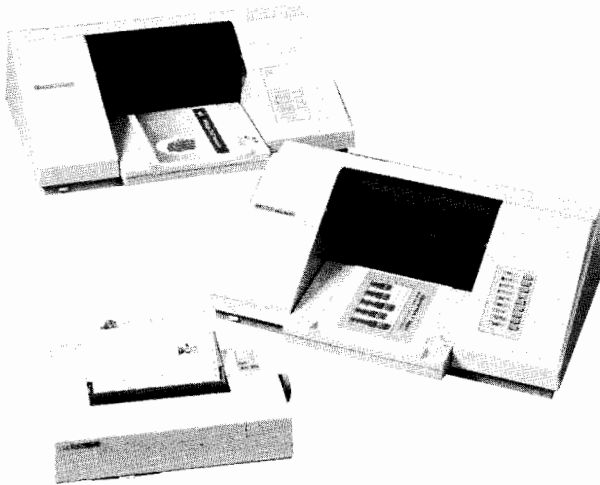

### Three Versatile Color Graphics Printers

Choose from three printer models. The HP PaintJet color graphics printer prints color graphics and text on A4/A-size Z-fold and cut-sheet paper, and also prints on A4/A-size transparency film for powerful presentations. The desktop size makes the HP PaintJet printer convenient for personal use in a wide range of applications.

The HP PaintJet XL and HP PaintWriter XL printers offer added speed and unattended operation for higher volume and shared environments. The built-in paper tray automatically feeds up to 200 sheets of paper and up to 70 sheets of transparency film. The HP PaintWriter XL is designed for use with Apple Macintosh computers, and includes AppleTalk capability for easy networking.

#### Technical Information

**Printing process:** thermal inkjet drop-on-demand printing.

**Text print speed:** 167 characters per second at 10 pitch, 200 characters per second at 12 pitch.

**Graphics resolution:** 180 x 180 dots per inch.

#### Printing styles

HP PaintJet/PaintJet XL: Courier 12 point (10 cpi), Letter Gothic 12 point (10 cpi), Letter Gothic 8 point (18 cpi); also bold, underline, superscript, and subscript.

HP PaintWriter XL/Color PrintKit for Macintosh Computers: AGFA Compugraphic CS Times, CS Triumvirate, CS Courier, and CS Symbol, scalable from 6-250 points.

**Media types:** paper, transparency film.

#### Media handling capability

HP PaintJet: manual feed for cut-sheet paper and transparency film; sprocket feed for Z-fold paper

HP PaintJet XL/HP PaintWriter XL: manual feed for cut-sheet paper and transparency film; automatic sheet feed for paper and transparency film.

#### Media sizes

HP PaintJet: A4/A

HP PaintJet XL/HP PaintWriter XL: A4/A and A3/B.<sup>1</sup>

#### Graphics print speed<sup>2</sup>

HP PaintJet: A4/A-size paper, 4 minutes or less; A4/A-size film, 8 minutes or less

HP PaintJet XL/HP PaintWriter XL: A4/A-size paper, 1.5 minutes or less; A4/A-size film, 3 minutes or less.

#### Print cartridges

HP PaintJet: 1 black and 1 multicolor

HP PaintJet XL/HP PaintWriter XL: 1 black, 1 cyan, 1 magenta, and 1 yellow.

#### Command language

HP PaintJet: HP PCL with extensions

HP PaintJet XL: HP PCL III with Imaging Extensions<sup>3</sup>

HP PaintWriter XL: Color QuickDraw

- Print on paper and transparency film
- Automatic sheet feed with PaintJet XL/PaintWriter XL
- A4/A-size PaintJet; A3/B-size PaintJet XL/PaintWriter XL

#### Internal character sets

HP PaintJet: HP Roman8, PC8, PC8 (Danish/Norwegian), ECMA94, US ASCII, ISO 7-bit languages: German, French, Italian, Norwegian, Swedish, Spanish, United Kingdom

HP PaintJet XL: All of the above plus PC850.

#### Buffer size

HP PaintJet: up to 8 Kbytes<sup>4</sup>

HP PaintJet XL: 50 Kbytes input; 189 Kbytes for downloadable fonts

HP PaintWriter XL: 17.2 Kbytes

#### Interfaces

HP PaintJet: RS-232-C/CCITT V.24 serial, HP-IB (IEEE 488-1978), and Centronics parallel options

HP PaintJet XL: RS-232-C/CCITT V.24 serial, Centronics parallel, and HP-IB (IEEE 488-1978) standard

HP PaintWriter XL: RS-422-A serial and AppleTalk

#### Power requirements

Source: 100, 120, 220, 240 Vac ( $\pm 10\%$ )

Frequency: 50-60 Hz

HP PaintJet: Consumption: 20W maximum

HP PaintJet XL/HP PaintWriter XL: Consumption: 65 W maximum, continuous

#### Physical specifications

##### HP PaintJet

Size: 98H x 442W x 302mmD (3.86" x 17.40" x 11.89")

Weight: net, 5kg (11 lb); shipping, 10.6 Kg (23.3 lb)

##### HP PaintJet XL/HP PaintWriter XL

Size: 230H x 750W x 441mmD (9.06" x 29.53" x 17.36")

Weight: net, 17.5 kg (39 lb); shipping, 24 kg (53 lb)

#### Ordering Information

	Price
HP 3630A PaintJet Color Graphics Printer	\$1,395
Opt 001 RS-232-C/CCITT V.24 serial interface	\$0
Opt 002 HP-IB (IEEE 488-1978) interface	\$0
Opt 004 Centronics parallel interface	\$0
HP C1602A PaintJet XL Color Graphics Printer	\$2,495
Opt 1AX RS-232-C/CCITT V.24 serial interface/ Centronics parallel interface	\$0
Opt 1A8 HP-IB (IEEE 488-1978) interface	\$0
HP C1613A PaintWriter XL Color Graphics Printer for Apple Macintosh Computers	\$2,995

Note: interface cables must be ordered separately.

#### Accessories Available

Description	Part Number
<b>HP PaintJet and PaintJet XL</b>	
HP Color PrintKit for Macintosh Computers (English version) <sup>6</sup>	17305B
HP Color PrintKit for Macintosh Computers (French version) <sup>6</sup>	17306B
HP Color PrintKit for Macintosh Computers (German version) <sup>6</sup>	17307B
<b>HP PaintJet XL only</b>	
HP PaintJet XL Font Cartridge (CG Times, CG Triumvirate, <sup>TM</sup> and Prestige Elite typefaces)	C1607A
HP-GL/2 Cartridge with two-megabyte page buffer and fonts	C1608A
B-size media handling kit (tray and 200 sheets of paper)	C1611A
A3-size media handling kit (tray and 200 sheets of paper)	C1612A

For further information on these products, order literature part number 5959-9750 and 5952-1290.

<sup>1</sup> Also uses intermediate paper sizes, including untrimmed ISO; these sizes are not available from HP.

<sup>2</sup> Output times vary depending on image complexity, application software, model of computer, and interface.

<sup>3</sup> Imaging extension capability is software dependent. PCL III is compatible with the HP PaintJet programming language.

<sup>4</sup> Varies depending on the use of downloaded characters.

<sup>5</sup> Size depends on destination.

<sup>6</sup> Requires RS-232-C interface.

Macintosh is a trademark of Apple Computer.

Microsoft is a U.S. registered trademark of Microsoft Corporation.

# COMPUTER PERIPHERALS

Personal, Departmental, and System Printers

HP 2225, 2227, 2228, 2235, C2106A, 2279A, 2934A

## HP ThinkJet Portable Printers HP 2225A/B/C/D/P

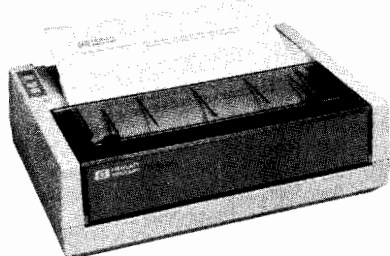

HP ThinkJet

The HP ThinkJet printer is a quiet, compact desktop printer that is very efficient (150 cps) and delivers crisp, easy-to-read text and graphics for letters, reports, and spreadsheets in draft or quality mode. Print cartridges are disposable, and there is excellent software support. Battery-powered versions for HP-IL and Centronics-type interfaces offer 200 page prints between recharges.

## HP QuietJet and QuietJet PLUS Printers HP 2227A/B, HP 2228A

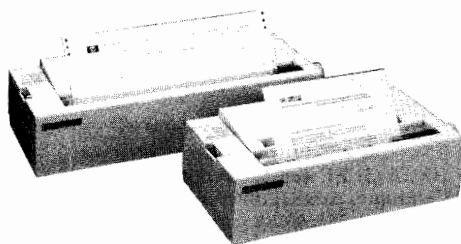

HP QuietJet

The HP QuietJet printers offer quality desktop printing at 192 cps draft and 48 cps NLQ for word processing, data base management, and computer graphics. The HP QuietJet handles standard 8.5 x 11-inch and A-4 size paper. The HP QuietJet PLUS also handles 15-inch wide paper. Both printers have excellent software support and use disposable print cartridges.

## HP RuggedWriter 480 Printer HP 2235 Series

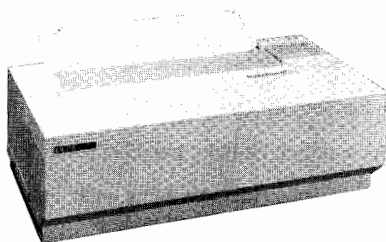

HP RuggedWriter 480

The wide-carriage HP RuggedWriter is a 24-wire impact dot-matrix printer that offers top-quality printing at 480 cps for draft and 240 cps letter quality. It has three independent paper paths and dual I/O, and it can print 6-part forms.

## HP DeskJet 500 Printer C2106A

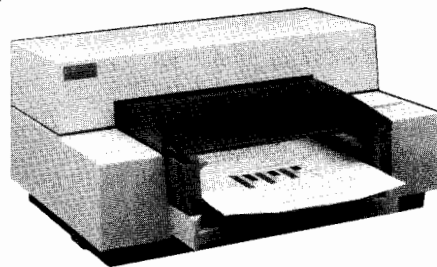

HP DeskJet 500

The HP DeskJet 500 printer is HP's most affordable 300 dpi printer. It is quiet and compact, and its fast laser-quality text and graphics beat impact dot matrix printers. The DeskJet 500 printer is up to two times faster in text and five times faster in graphics than the original DeskJet. It offers built-in landscape mode and more font capability including kerning. Its features include two font cartridge slots and a built-in sheet feeder that easily accommodates envelopes, an MS Windows 3.0 driver complete with scalable fonts in sizes up to 127 points. It is compatible with more than 500 software packages. Epson FX-80 and IBM Proprinter III emulation cartridges are optional. Three-year warranty is standard.

## HP DeskWriter Printer HP 2279A

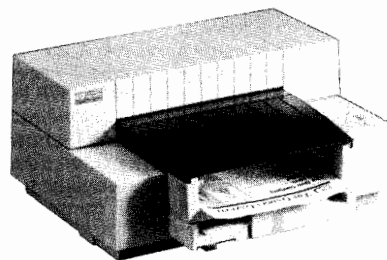

HP DeskWriter with Apple Talk

The HP DeskWriter is HP's most affordable 300 dpi printer for the Macintosh. The Quickdraw-based printer comes with both serial and AppleTalk interfaces for interface flexibility. Four font families come standard in the product, with the option to expand to 11. All font families include plain, bold, italic, and bold italic versions. They provide smooth, crisp text in any size up to 250 points. Third-party font software such as Adobe Type Manager gives DeskWriter unlimited font flexibility. Using the printer is plug-and-go easy. The HP DeskWriter printer works with Fifth generation's SuperlaserSpooler software.

## HP 2934A Impact Printer

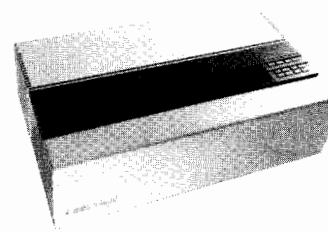

HP 2934A Impact Printer

Speed, reliability, simplicity of operation, and unlimited duty cycle allow the HP 2934A 136-column impact printer to meet heavy printing needs (up to 12,000 pages/month). It prints 200 cps and offers near letter quality (NLQ), font cartridges, bar codes, OCR, large character generation, and 6-part forms printing.

\*Macintosh is a registered trademark of Apple Computer, Inc.

# COMPUTER PERIPHERALS

## Personal, Departmental, and System Printers

691

HP 33471A, 33449A, 33459A, 2684A/P/D

HP 2680A, 2685C

### HP LaserJet Printer Family

All HP LaserJet printers provide publication-quality print, quiet operation, auto-rotation of fonts, and fast graphics formatting, and they are supported by all major software packages. Options for desktop models include the AppleTalk interface kit, Post Script printer cartridge, and accessory memory.

#### HP LaserJet IIP printer HP 33471A

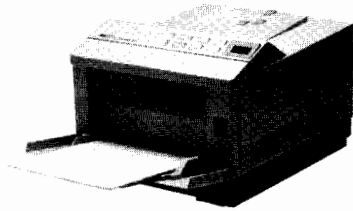

HP LaserJet IIP

- Personal
- Affordable
- Optional lower paper cassette for dual-bin functionality
- Font flexibility

This printer prints up to 4 pages per minute and includes 1 font cartridge slot, an input tray that holds either 50 sheets or 5 envelopes, and 14 bit-mapped internal typefaces. Options include a 250-sheet paper cassette for dual-bin functionality and an envelope tray. Optional Epson FX IBM Proprinter language emulation is also available.

#### HP LaserJet III Printer HP 33449A

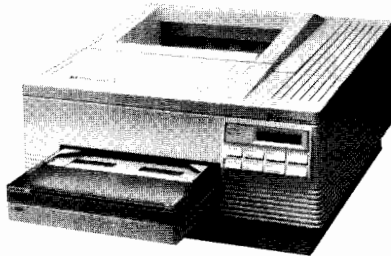

#### HP LaserJet III

- New improved print quality
- Enhanced page-formatting features
- Faster graphics printing
- More font flexibility

This printer prints at 8 pages per minute. The printer offers the new Resolution Enhancement technology, PCL 5 printer language, and HP-GL/2 vector graphics. Included are 2 font cartridge slots, a 200-sheet input tray, and 8 scalable and 14 bit-mapped typefaces built in.

#### HP LaserJet IIID printer HP 33459A

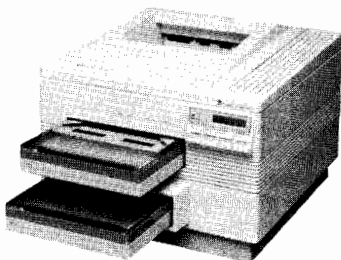

- Advanced paper handling
- Improved print quality
- Enhanced page-formatting features
- Faster graphics printing

The HP LaserJet IIID offers advanced paper handling in addition to the other features of the LaserJet III printer. Its two input trays, two-sided printing, optional power envelope feeder, and high duty cycle make it ideal for shared use. The printer comes with 2 cartridge slots, and 8 scalable and 14 bit-mapped internal typefaces.

#### HP LaserJet MasterType Library and Memory

The HP MasterType Library for LaserJet printers offers 12 solution-oriented bit-mapped font cartridges, 4 soft fonts, and over 100 scalable typefaces on disks and cartridges. All LaserJet printers have optional upgradeable memory for increased font and graphics capability.

#### HP LaserJet 2000 Printer HP 2684 A/D/P

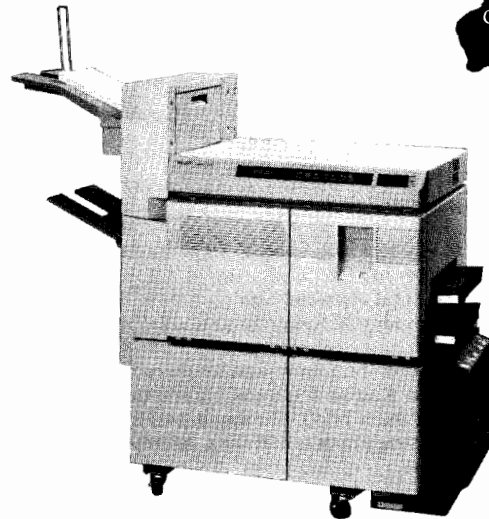

#### HP LaserJet 2000

- High-speed, high-resolution text and graphics
- High-volume capability (up to 100,000 pages per month)
- Prints on six paper sizes up to and including ledger size (11 x 17 in., A3)
- Automatic two-sided printing (duplex)
- Automatic font and graphics rotation
- Contains 34 internal fonts

The HP LaserJet 2000 printer prints up to 20 pages/minute for high-volume, high-speed printing for minicomputers and PC networks. Two 250-sheet input trays, a 1500-sheet correct-order output stacker, 3 font cartridge slots, and 34 resident fonts are standard. Options include two-sided printing, a 2000-sheet paper tray and a LAN connection for Novell NetWare networks.

#### HP 2680A Laser Printing System

- Up to 45 pages per minute
- Up to 1,000,000 sheets per month
- Continuous paper feed (8.5 x 11-inch fanfold paper)
- Non-contact fusing
- Up to four pages of print on one sheet of paper
- Variable-size characters

This printing system serves HP 3000 and Precision Architecture systems. Other features include high-volume label printing, merged text, graphics, electronics forms capabilities IFS/3000, ID-SFORM/3000, and other applications.

#### HP 2685C Laser Print Station

The HP 2685C Laser Print Station is a local or remote print system for mainframe systems. It includes the HP 2680A laser printer, system controller, terminal, and disk and tape drives.

# COMPUTER PERIPHERALS

## Personal, Departmental and System Printers

### HP 2562C, 2563C, 2564C, 2566C, 2567C

#### Hewlett-Packard Dot Matrix Line Impact Printers

The HP 256X C family of line impact dot matrix printers offers superior quality, fast and reliable printing for commercial, industrial or data processing environments. The selection of different character sets, raster graphics and standard industry interfaces, including HP 3000, 9000, and 1000 system compatibility, allows flexibility to customize the printers for individual printing needs. Other features include multi-part forms printing, paper out and paper jam detection, a 16-channel downloadable vertical forms control (VFC), and easy forms alignment.

#### HP 2562C Dot Matrix Printer

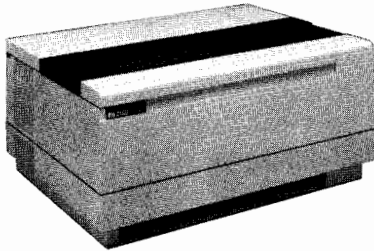

HP 2562C Printer

- Prints up to 420 lpm high-speed draft character set
- 25,000 pages per month
- Contains 6 internal character sets
- Enhanced Bar code/OCR options available
- Desktop model

This printer features the 6 most popular character sets: 13.3 cpi compressed, standard Roman 8 USASCII, line draw, large block, bar codes, and high-density NLQ. The sound level is 64 dB. High reliability is ensured through memory backup, microprocessor control, and few moving parts.

#### HP 2563C/HP 2564C Line Impact Dot Matrix Printers



HP 2563C

- HP-IB interface, RS-232C/422, Centronics
- 63,000/230,000 pages per month
- 420/840 lpm high speed draft character set
- Paper stacking aid
- 55dB quietized cabinet

These printers offer a wide selection of different character sets, raster graphics and standard industry interfaces (including HP 3000, 9000, and 1000 system compatibility) allowing customization for individual printing needs. They are equipped with a paper stacking aid which has a removable basket. This allows easy paper removal for the operator and ensures clean, efficiently stacked output.

#### HP 2566/67C Line Impact Dot Matrix Printers



HP 2567C

- HP-IB interface, RS-232C/422, Centronics
- 530,000/650,000 pages per month
- 1200/1600 lpm high speed draft character set
- powered paper stacker

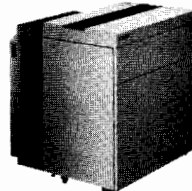

The HP 2566/67C line impact dot matrix printers offer superior quality, fast and reliable printing. These printers are equipped with a state of the art powered paper stacker that will stack a full box of paper and greatly reduce misstacks and paper jams. The stacker only operates when the printer is moving paper, reducing the noise level and preventing unnecessary wear and tear.

#### Ordering Information

##### HP ThinkJet Family Printers

	Price
HP 2225A ThinkJet printer, HP-IB	\$595
HP 2225B ThinkJet printer, HP-IL, battery power	\$595
HP 2225C ThinkJet printer, Centronics	\$595
HP 2225D ThinkJet printer, RS-232	\$595
HP 2225P ThinkJet printer, Centronics, battery power	\$595
Accessory HP 922197 cable	+\$49

##### HP QuietJet family printers

HP 2227A QuietJet printer, dual I/O (Centronics/RS-232), wide carriage	\$849
HP 2227B QuietJet printer, HP-IB, wide carriage	\$849
HP 2228A QuietJet printer, dual I/O (Centronics/RS-232)	\$649

##### HP DeskJet 500 printer

HP C2106A DeskJet 500 printer, dual I/O (Centronics/RS-232)	\$729
---	-------

##### HP DeskWriter printer with Apple Talk

HP 2279A DeskWriter printer, Apple Talk, and serial I/O to Macintosh	\$995
--	-------

##### HP 2934 Printer

HP 2934A Printer, RS-232/RS-422	\$2,795
Opt 042 Centronics-type interface	+\$50
Opt 046 HP-IB interface	+\$150

##### HP RuggedWriter 480 Printers

HP 2235A RuggedWriter printer, dual I/O (Centronics/RS-232)	\$1,895
HP 2235B RuggedWriter printer, dual I/O (HP-IB/RS-232)	\$2,095
HP 2235C RuggedWriter printer, dual I/O (Centronics/RS-232) w/ sheet feeder	\$2,145
HP 2235D RuggedWriter printer, dual I/O (HP-IB/RS-232) w/ sheet feeder	\$2,345

##### Accessories

HP 12239A sheet feeder - US letter-size	\$300
HP 12239B sheet feeder - EUR A4 size	\$300
HP 12235A font cartridge - 4 fonts and 16K RAM	\$150

##### HP LaserJet family printers

HP 33471A LaserJet IIP printer	\$1,495
HP 33449A LaserJet III printer	\$2,395
HP 33459A LaserJet IIID printer	\$3,595
HP 33416A AppleTalk interface kit for LaserJet III, IIID and IID printers	\$275

HP 33417A AppleTalk interface kit for LaserJet IIP printer	\$275
--	-------

HP 33439P PostScript cartridge for LaserJet IID, IIP, III and IIID printers	\$695
---	-------

33477A Epson FX/IBM Proprinter Emulation cartridge for the HP LaserJet printer	\$175
--	-------

HP 33480A HP LaserJet printer LAN connection for Novell NetWare networks	\$949
--	-------

Opt. 001 Ethernet connection	\$949
------------------------------	-------

HP 2684A/P/D LaserJet 2000 printer	\$19,995-
Cable, interface, and installation not incl.	\$25,695

Opt 048 RS-232-C/RS-422-A	+\$500
---------------------------	--------

Opt 052 Dataproducts Short Line	+\$500
---------------------------------	--------

Opt 053 Centronics	+\$500
--------------------	--------

Opt 054 Dataproducts Long Line	+\$500
--------------------------------	--------

Opt 055 No Interface Required	\$0
-------------------------------	-----

##### Line impact dot matrix printers

HP 2562C line impact dot matrix printer 420 lpm	\$5,500
---	---------

HP 2563C line impact dot matrix printer 420 lpm	\$8,490
---	---------

HP 2564C line impact dot matrix printer 840 lpm	\$13,490
---	----------

HP 2566C line impact dot matrix printer 1200 lpm	\$26,950
--	----------

HP 2567C line impact dot matrix printer 1600 lpm	\$34,000
--	----------

##### High-volume laser printers

HP 2680A Laser printer system	\$95,470
-------------------------------	----------

HP 2685C Laser print station	\$97,800
------------------------------	----------

- Designer color system

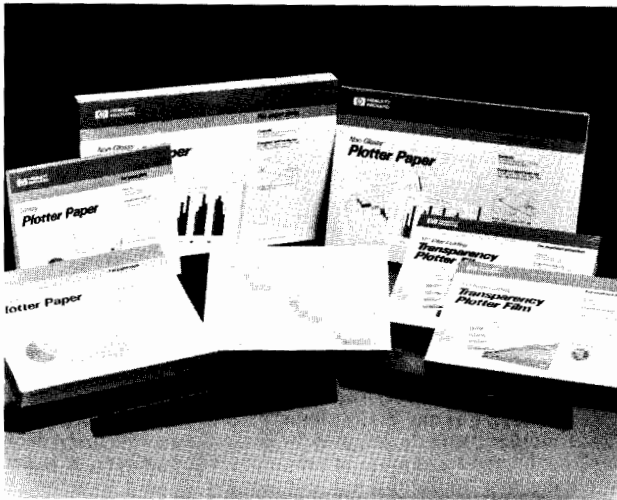

Hewlett-Packard offers a complete line of pens, drawing media, and accessories for both business and technical graphics applications. And all these supplies are manufactured in the HP tradition of quality — quality that you'll see reflected in your work.

### Designer Color System

HP's family of compatible plotter supplies consists of fiber-tip paper pens and transparency pens, glossy plotter paper and transparency plotter film. The fiber-tip pens are available in 10 matching colors so that you can create paper duplicates of your transparencies. Pen colors are black, green, aqua, blue, violet, red-violet, red, orange, yellow and brown. Pens are available in narrow and wide line widths (0.3 mm and 0.7 mm for paper pens; 0.3 mm and 0.6 mm for transparency pens).

Paper pens can be used on all plotters. You can obtain high quality results with HP plotter paper for graphs and large quantities. Use HP glossy paper for reports and presentations. Transparency pens can be used on the HP ColorPro, DraftPro DXL and EXL, DraftMaster Series, 7475, 7550, and 7090, plotters with HP transparency film for overhead presentations or with HP glossy paper for presentation handouts.

Quality color overheads help you make a point, sell a product or idea, enhance an image. Research proves that:

- presentations using visual aids are 43% more effective than unaided presentations,
- color is more persuasive than black and white for visuals,
- an average speaker using visuals can be as effective as a better speaker using no visuals.

Overall, presenters using color overheads were rated as more credible and more interesting by the audience.

### Technical Drafting Applications

Hewlett-Packard offers three different types of pens and four different types of media so you can select the pen/media combination that's right for your application. Fiber-tip pens are available in ten colors for use on plotter paper. Roller-ball pens come in four colors and are capable of plotting at 110 cm/s (43 in/s). In addition to four line widths for disposable drafting pens, HP offers long-body and short-body drafting pens in six line widths.

Sheets of plotter paper, vellum, tracing bond, and polyester film, are available in a range of sizes, both English (A to E) metric (A4 to A0) and architectural (C-E). Polyester film, vellum, and plotter paper come in 914.4 mm (36 in.) and 609.6 mm (24 in.) rolls for use with the HP DraftMaster RX and MX roll-feed drafting plotters.

- HP SurePlot disposable drafting pens



### HP SurePlot Disposable Drafting Pens

HP SurePlot disposable drafting pens provide the quality and dependability required for optimum productivity. HP SurePlot disposable drafting pens have a ceramic tip for clog-free plotting. The specially designed regulator makes them leak-free, too. HP SurePlot pens are convenient and easy to use, with no assembly or maintenance required.

### Ordering Information

Plotter supplies may be ordered through HP's direct telephone ordering service, from any HP sales and support office, or from your local retail dealer. The HP Computer User's Catalog (P/N 5953-2450) describes the complete range of plotter supplies and accessories.

### For Best Results

	Paper	Glossy Paper Transparency Film	Tracing Bond	Vellum	Polyester Film
Fiber-tip pens (paper)	ColorPro 7475 7550 Plus DraftPro Series DraftMaster Series 7580 Series				
Fiber-tip pens (transparency)		ColorPro 7475 7550 DraftPro DXL DraftPro EXL DraftMaster Series			
Roller-ball pens	7550 Plus DraftPro Series DraftMaster Series 7580 Series		DraftPro Series DraftMaster Series 7580 Series		
Disposable drafting pens	7550 Plus DraftMaster Series 7580 Series			7550 Plus DraftPro Series DraftMaster Series 7580 Series	7550 Plus DraftPro Series DraftMaster Series 7580 Series
Refillable drafting pens				7475 7550 Plus DraftPro Series DraftMaster Series 7580 Series	7475 7550 Plus DraftPro Series DraftMaster Series 7580 Series

# COMPUTER PERIPHERALS

## Desktop Plotters—Precision Color for Charts and Drawings

### HP 7475A, 7440A

- High-quality output
- Drafting capability
- Six-pen carousel

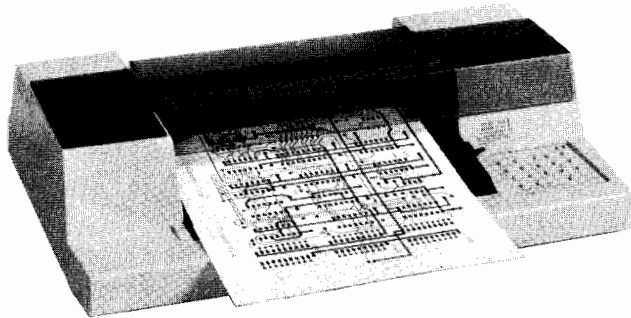

HP 7475A

The HP 7475A is a low-cost plotter that provides the kind of graphics excellence and versatility you would expect to find in a much more expensive plotter. The HP 7475A produces fast, high-quality drawings for business, design, and measurement professionals.

#### Applications

**Business:** The HP 7475A produces colorful A4/A-size charts for reports, meetings, presentations, and transparencies. The A3/B-size capability of the HP 7475A makes it the ideal plotter for PERT charts, organization charts, flowcharts, or small flip charts.

**Design:** Perfect as an entry level drafting plotter or an inexpensive companion to your design system, the HP 7475A creates liquid-ink drawings on polyester film for frequently handled archival copies or check plots using fiber-tip pens on paper.

**Measurement:** The HP 7475A adds hardcopy graphics capability to intelligent instruments and instrument systems with an HP-IB (IEEE 488-1978) interface. Many systems (with or without display screens) can have the benefits of high-quality, hard-copy graphics plotted directly from measured data.

#### Technical Information

**Resolution:** Smallest addressable step size, 0.025 mm (0.001 in.)

**Repeatability:** with a given pen, 0.1 mm (0.004 in.); from pen to pen, 0.2 mm (0.008 in.)

**Pen velocity (each axis):** pen up, 50.8 cm/s (20 in/s); pen down, maximum, 38.1 cm/s (15 in/s); programmable, 1 to 38 cm/s in 1 cm/s increments

**Acceleration:** approximately 2 g's

**Environmental range:** operating, 0°C to 55°C 5 to 95% Rh (at 40°C); non-operating, -40°C to 75°C

**Plotting area:** x-axis, 258 mm (10.2 in.), A/B; 275 mm (10.8 in.), A4/A3; y-axis, 198 mm (7.80 in.), A; 192 mm (7.56 in.), A4; 414 mm (16.3 in.), B; 402 mm (15.8 in.), A3

**Interfaces:** HP-IB (IEEE 488-1978) implements the following functions as defined in IEEE 488-1978 — SH1, AH1, T2, TE0, LE0, SR1, RL0, DC1, DT0, L2, PP0 (listen only or address less than 7, otherwise PP2); RS-232-C/CCITT V.24, asynchronous serial ASCII with switch selectable baud rates of 75, 110, 150, 200, 300, 600, 1200, 2400, 4800, 9600. External clock input capabilities with intermediate baud rates of up to 9600 baud; 1024 byte buffer

**Power requirements:** source, 100, 120, 220, 240 V ~ -10%, +5%; frequency, 48-66Hz

**Size:** 127H x 568W x 367mmD (5.0" x 22.4" x 14.5")

**Weight:** net, 7 kg (16.0 lb); shipping, approx. 11 kg (24.0 lb)

**FCC:** FCC certified to limits set for radio frequency interface when used with a class B computing device

#### Accessories Supplied

HP 07475-90002 Operation and Interconnection Manual

HP 07475-90003 Reference Card

Print Cache - print buffer

Power cords and an assortment of pens and drawing media are also supplied with the plotters. The media size and appropriate power supply are determined by plotter destination.

NOTE: Interface cables are not supplied with the plotter. They must be ordered separately.

#### Ordering Information

HP 7475A Six-pen graphics plotter

Opt 001 RS-232-C/CCITT V.24 (cable not included) \$0

Opt 002 HP-IB (IEEE 488-1978) (cable not included) \$0

#### Accessories

HP 07475-90001 Interfacing and Programming Manual \$20

☎ For same-day shipment, call HP DIRECT at 800-538-8787.

- Eight-pen carousel
- Handles A4/A-size paper, transparency film
- ROM cartridge slot

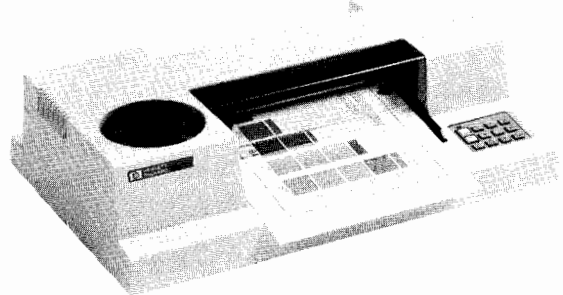

HP 7440A

The HP ColorPro eight-pen plotter is designed to provide quick, presentation-quality color visuals for business and scientific applications. It draws with fiber-tip pens on overhead transparency film and regular plotter paper and glossy plotter paper.

The ColorPro plotter is designed for professionals who make decisions from numbers and make presentations with numbers. Whether you are drawing overheads for a meeting or recording data from a smart instrument, output quality is important. The exceptional line quality of the ColorPro plotter makes drawings and charts perfect for most professional presentations or reports.

#### Technical Information

**Resolution:** smallest addressable step size, 0.025 mm (0.001 in.)

**Repeatability:** with a given pen, 0.1 mm (0.004 in.)

**Pen velocity (each axis):** pen up, approx. 52.0 cm/s (20.5 in/s); pen down, maximum, approx. 40.0 cm/s (15.7 in/s); programmable, 1.0 to 40.0 cm/s in 1.0 cm/s increments

**Acceleration:** approximately 1.2 g's

**Environmental range:** operating, 0°C to 55°C, 5% to 95% Rh (at 40°C), non-operating, -40°C to 75°C

**Maximum plotting area:** pen axis, 191 mm (7.5 in.) for A and A4; paper axis, 272 mm (10.7 in) for A4, 257 mm (10.1 in) for A

**Interfaces:** HP-IB (IEEE 488-1978) interface which implements IEEE 488-1978 standards; RS-232-C/CCITT V.24, asynchronous serial ASCII with switch selectable baud rates of 75, 110, 150, 200, 300, 600, 1200, 2400, 4800, 9600; 60-byte buffer

**Power requirements:** source, 100, 120, 200, 240 V ~ -10%, +5%; frequency, 48-66 Hz; consumption, 20 W maximum

**Size:** 125H x 460W x 308 mmD (4.9" x 18.1" x 12.1")

**Weight:** net, 5.5 kg (12.0 lb); shipping, approx. 8.6 kg (19.0 lb)

**FCC:** FCC certified to conform to limits set for radio frequency interference when used with a class B computing device. Meets or exceeds IEC-380, IEC-435, UL-478

#### Accessories Supplied

HP ColorPro Graphics Plotter Operating Manual

Power supply

Print Cache-print buffer

An assortment of pens and media are also supplied with the plotter. The media size and appropriate power supply are determined by plotter destination.

NOTE: Interface cables are not supplied with the plotter. They must be ordered separately.

#### Ordering Information

HP 7440A ColorPro plotter

Opt 001 RS-232-C/CCITT V.24 (cable not included) \$0

Opt 002 HP-IB (IEEE 488-1978) (cable not included) \$0

HP 17440A Graphics enhancement cartridge \$165 ☎

#### Interface Cables

HP 13242-60010 M-M special RS-232-C cable for use with Option 001, HP 150 Personal Computers, HP Vectra PC with HP 24541B interface \$69 ☎

HP 24542G F-M special RS-232-C cable for use with Option 001, HP Vectra PC with HP 24540A interface, IBM AT \$60 ☎

HP 10833A HP-IB 1-metre cable for use with Option 002 \$80 ☎

HP 10833A HP-IB 1-metre cable for use with Option 002 \$80 ☎

HP 10833A HP-IB 1-metre cable for use with Option 002 \$80 ☎

HP 10833A HP-IB 1-metre cable for use with Option 002 \$80 ☎

HP 10833A HP-IB 1-metre cable for use with Option 002 \$80 ☎

# COMPUTER PERIPHERALS

## Plotters - High-Speed, High-volume, Automatic Sheet Feed

695

HP 7550B

- Fast throughput with extensive built-in intelligence
- 1- or 2-megabyte memory board option
- HP-GL (7550A emulation) and HP-GL/2 language capability

- Best media flexibility and pen versatility in a desktop plotter
- Flexible interface options
- Front-panel operation

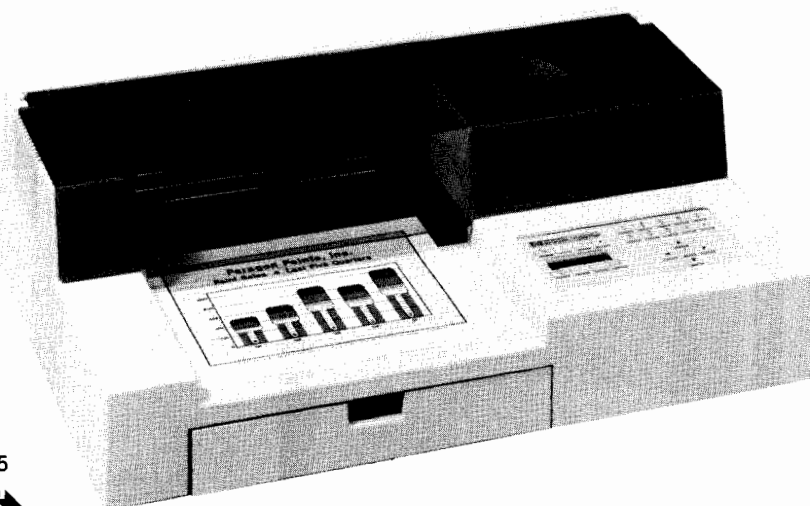

Option 005



### HP 7550 Plus Plotter

#### Fast, High-volume Plotter With Automatic Sheet Feed

The high-volume 7550 Plus plotter adds new features to the popular HP 7550A plotter, making it very useful in shared-use and high-volume environments.

New built-in intelligence and fast pen speed make the 7550 Plus the fastest desktop plotter on the market. Yet users will not sacrifice precision for speed—the plotter's high resolution means straight lines and smooth curves every time.

The HP 7550 Plus offers these additional advantages: improved automatic sheet feed capabilities for reliable, unattended operation; a 1- or 2-megabyte memory board option for continuous plotting without losing computer control and for multiple-copy and replot capabilities; and HP-GL/2, which puts advanced graphics power on the desktop.

Marking another first for desktop plotters, the HP 7550 Plus is now available in two configurations: Centronics (one parallel and one serial connector), which is ideal for PC users; and HP-IB (one HP-IB and two serial connectors), which is identical to the 7550A's configuration and supports eavesdrop capability.

#### Technical Information

**Media sizes:** accommodates ISO A4 (210 × 297 mm), ANSI A (8.5 × 11 in), ISO A3 (297 × 420 mm), and ANSI B (11 × 17 in)

**Media:** paper (regular and glossy), transparency film, vellum, double-matte polyester film (automatic sheet-feed for regular paper and transparency film only)

**Pens:** 8 per carousel, fiber-tip (paper and transparency), roller-ball, and liquid-ink (refillable and disposable)

**Resolution:** addressable, 0.025 mm (0.001 in); mechanical, 0.00625 mm (0.00025 in)

**Repeatability:** with a given pen, 0.1 mm (0.004 in)

**Pen velocity:** pen down, maximum, 80 cm/s (31.5 in/s); programmable 1 to 80 cm/s in increments of 1 cm/s

**Acceleration:** approximately 6 g

**Pen force:** -15 to 66 grams

**Plotting area:** pen axis, 254 mm (9.97 in) for A/B, 272 mm (10.65 in) for A4/A3; paper axis, 196 mm (7.68 in) for A, 190 mm (7.45 in.) for A4, 411 mm (16.12 in) for B, 399 mm (15.65 in) for A3

**Buffer size:** 32 Kbytes; 1 or 2 megabytes with optional memory boards

**Character sets:** (Each in two fonts) French/German, HP 9825, Scandinavian, Spanish/Latin American, Roman Extensions, and

these ISO registered sets: ANSI ASCII (006), French (025), German (021), International Reference Version (002), Italian (015), JIS ASCII (014), Katakana (013), Norwegian I (060), Norwegian II (061), Portuguese (016), Spanish (017), Swedish (010), Swedish for Names (011), United Kingdom (004)

**Environmental ranges:** operating, 0 to 55 degrees C; storage, -40 to 75 degrees C; humidity, operating with automatic sheet feed (transparency): 25 to 75% (at 15 to 35 degrees C)

**Power requirements:** source, 100, 120, 220, 240 V, -10%, +5%; frequency, 48-66 Hz; consumption, 105 W maximum

**Size:** minimum, A4/A, no catcher, 215H × 670W × 432mmD (8.5" × 26.4" × 17.0"); maximum, A3/B, with catcher, 215H × 670W × 896mmD (8.5" × 26.4" × 35.3")

**Weight:** net 17.3 kg (38.0 lb), shipping 25.0 kg (55.0 lb)

#### Accessories Supplied

Users guide, computer information<sup>1</sup>, power cord<sup>1</sup>, plotter paper sampler<sup>1</sup>, transparency film sampler<sup>1</sup>, carousel for fiber-tip pens, carousel for fiber-tip transparency pens, assorted fiber-tip paper and transparency pens, automatic sheet-feed equipment<sup>1</sup>, and HP Supplies Source.

#### Ordering Information

HP 7550B, HP 7550 Plus color desktop plotter	Price
Opt 005 HP-IB/two RS-232-C/CCITT V.24/ RS-422-A/eavesdrop	\$4,195.00
Opt 006 Centronics/one RS-232-C/CCITT V.24	\$3,995.00

#### Accessories Available

HP 33474B 1-Megabyte memory board	\$335.00
HP 33475B 2-Megabyte memory board	\$560.00
HP 17092A Automatic sheet-feed kit for 11 × 17 in media (B size), includes loading tray, paper catcher, and 50 sheets of 11 × 17 in paper	\$176.00
HP 17093A Automatic sheet-feed kit for 297 × 420 mm media (A3 size), includes loading tray, paper catcher, and 50 sheets of 297 × 420 mm paper	\$176.00
HP 5959-9733 HP-GL/2 Reference Guide	\$39.75
HP 5959-9734 HP-GL/2 Product Comparison Guide	\$25.00

For further information on this product, order literature part number 5952-2214.

<sup>1</sup>Media size, language, and power specifications appropriate to plotter destination.

# COMPUTER PERIPHERALS

## Plotters—Low-cost, Eight-pen Drafting Plotters

### HP DraftPro Series Plotters

- Compatible with popular hardware and software
- HP-GL Graphics Language
- Wide variety of pen/media choices
- HP quality and reliability
- One- and two-megabyte buffer options for HP DraftPro DXL and EXL

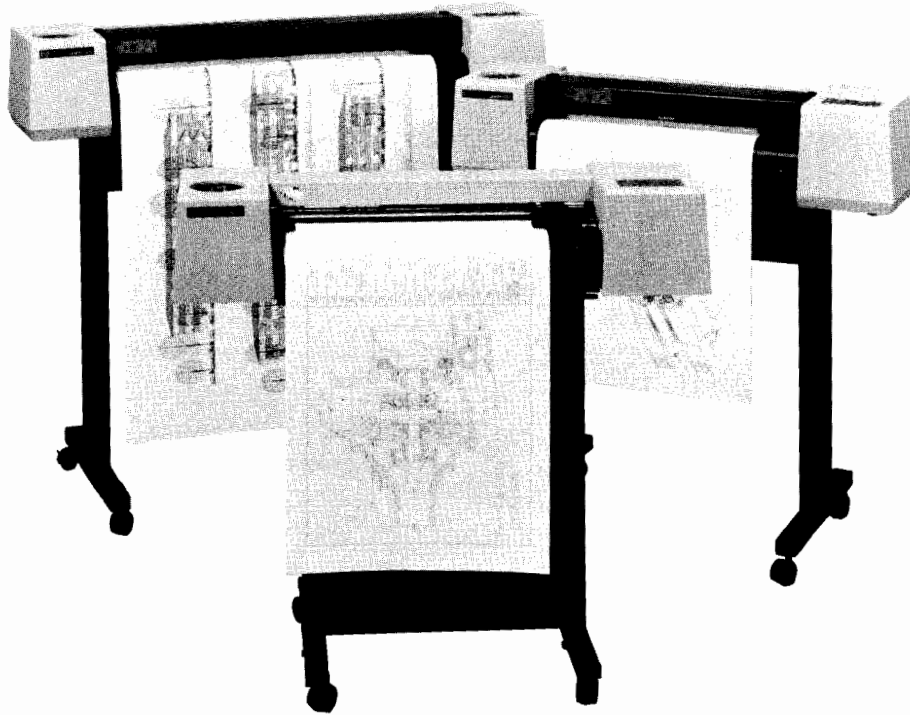

The HP DraftPro Series plotters meet the needs of CAD professionals. The HP DraftPro plotter accepts C/A2 and D/A1 media; HP DraftPro DXL accepts A/A4 through D/A1 media; and the HP DraftPro EXL accepts A/A4 through E/A0 media (all standard ISO, ANSI, and architectural sizes including 30 x 42-in media).

#### Hardware and Software Compatibility

Over 100 software packages work with HP DraftPro Series plotters, including all leading architectural, mechanical, and electronic PC CAD software.

HP DraftPro Series plotters connect easily to most HP and other personal computer/workstations. An RS-232-C serial interface is standard; HP-IB (IEEE 488-1978) can be ordered as an accessory.

#### HP-GL Command Set

The HP DraftPro Series plotters use HP-GL (Hewlett-Packard Graphics Language). With just a few commands you can label, draw lines, arcs, and circles, or select one of 21 international character sets (20 for the standard HP DraftPro model).

Although most plotter manufacturers claim to emulate HP-GL, only HP plotters have the original HP-GL tested and approved by Hewlett-Packard.

#### Line Quality

With a mechanical resolution of 0.0125 mm (0.0005 in) and an addressable resolution of 0.025 mm (0.001 in), the HP DraftPro Series plotters draw well defined lines, smooth curves, and crisp characters that help you and your designs look their best. The 0.10 mm (0.004 in) repeatability means your drawings have the professional quality you need.

#### Integrates Into Your Environment

Quiet operation makes the HP DraftPro DXL and EXL plotters a good fit in an office environment. Because the HP DraftPro Series plotters have wheels, they are easy to move and share.

#### Output for Every Application

The HP DraftPro Series plotters have the necessary pen and media flexibility to get the job done. Each plotter can plot on paper, vellum,

and polyester film. They draw with fiber-tip paper pens, HP SurePlot disposable drafting pens, and refillable drafting pens. For presentations, the HP DraftPro DXL and EXL use glossy paper or transparency film with transparency pens.

From the front panel you can select the pen speed that optimizes performance and line quality for your pen/media combination. The eight-pen carousel lets you use a variety of colors and line widths with ease. Pens are changed automatically during plotting, and they are automatically capped when not in use to increase the life of the pens.

#### HP Quality and Reliability

Equipment downtime costs time and money. That is why the HP DraftPro Series plotters meet the same tough standards for quality and reliability that have made HP pen plotters leaders in the industry.

The HP DraftPro Series plotters have a one-year warranty. After the first year, on-site service contracts are available at the lowest prices in the industry.

The combination of reliability, quality, performance, flexibility, and support makes these plotters an excellent value and a smart choice in drafting plotters.

#### Plotting Speed

The HP DraftPro Series plotters have 2.8 g maximum (diagonal) acceleration. The DraftPro DXL and EXL have a maximum velocity of 80 cm/s (32 in/s); the DraftPro has a maximum velocity of 40 cm/s (15.7 in/s). All three models have a pen-sorting feature that minimizes pen changes for more efficient plotting.

#### Two Plug-in Buffer Options

Two plug-in buffer options are available as accessories for both the HP DraftPro DXL and EXL plotters.

The easy-to-install cartridges are available in one- and two-megabyte options to let you quickly download an entire plot, freeing your computer for other tasks. (Cannot be used with HP-IB interface).



## Technical Information

### Media Sizes

The HP DraftPro series plotters accommodate the standard ISO, ANSI, and architectural sizes listed below:

#### HP DraftPro

C/A2 to D/A1, including widths from 550 mm to 640 mm (21.65 in to 25.20 in), lengths from 400 mm to 1000 mm (15.75 in to 39.37 in)

#### HP DraftPro DXL

A/A4 to D/A1, including widths from 205 mm to 335 mm (8.07 in to 13.19 in) and from 365 mm to 645 mm (14.37 in to 25.39 in), lengths from 215 mm to 1140 mm (8.46 in to 44.88 in)

#### HP DraftPro EXL

A/A4 to E/A0, including widths from 205 mm to 491 mm (8.15 in to 19.33 in) and from 520 mm to 927 mm (20.47 in to 36.50 in), lengths from 215 mm to 1230 mm (8.46 in to 48.43 in)

**Number of Pens:** 8 in carousel

### Pen Type

#### HP DraftPro

Fiber-tip paper, HP SurePlot disposable drafting, refillable drafting

#### HP DraftPro DXL/EXL

Fiber-tip paper, fiber-tip transparency, HP SurePlot disposable drafting, refillable drafting

### Media

#### HP DraftPro

Paper, vellum, double-matte polyester film

#### HP DraftPro DXL/EXL

Paper, vellum, double-matte polyester film, glossy paper, transparency film

### Character Sets

French/German, HP 9825, Scandinavian, Spanish/Latin American, Roman Extensions, Special Symbols, Drafting, Kanji, and these ISO registered sets: ANSI ASCII (006), French (025), German (021), International Reference Version (002), Italian (015), JIS ASCII (014), Katakana (013), Norwegian I (060), Norwegian II (061), Portuguese (016), Spanish (017), Swedish (010), Swedish for Names (011), United Kingdom (004); HP DraftPro DXL/EXL also use ECMA 94 Extensions (100); Kanji is available with an optional cartridge.

### Resolution

Addressable: 0.025 mm (0.001 in)

Mechanical: 0.0125 mm (0.0005 in)

### Repeatability

0.10 mm (0.004 in) for the same pen on 0.08 mm (0.003 in) double-matte polyester film at 10-30 degrees C, 20-80% relative humidity

### Accuracy

0.5 mm (0.02 in) or 0.2% of the specified line length, whichever is greater, on 0.08 mm (0.003 in) double-matte polyester film at 10-30 degrees C, 20-80% relative humidity

### Maximum Pen Velocity

HP DraftPro: 40 cm/s (16 in/s)

HP DraftPro DXL/EXL: 80 cm/s (32 in/s)

### Maximum Acceleration

Diagonal 2.8g

Axial 2.0g

### Pen Cycle Time

HP DraftPro: 100 ms

HP DraftPro DXL/EXL: 67 ms

### Margins

Expanded mode: 5.0 mm (0.2 in) on three edges, 31.0 mm (1.2 in) on the fourth

Normal mode: 15.0 mm (0.59 in) on three edges, 39.0 mm (1.5 in) on the fourth

### Buffer Size

HP DraftPro: 7.2 Kbyte

HP DraftPro DXL/EXL: 31 Kbyte standard buffer (shared between user-definable polygon and pen sort buffers). Optional one- and two-megabyte plug-in buffers are available as accessories (Cannot be used with HP-IB interface).

### Environmental Ranges

#### Temperature

Operating: 0 to 55 degrees C (32 to 131 degrees F)

Storage: -40 to 75 degrees C (-40 to 167 degrees F)

Humidity: 5 to 95% (in 0 to 40 degrees C)

#### Acoustics<sup>1</sup>

Operating pressure: 58 dB(A)

Idle pressure: 42 dB(A)

(These specifications are typical sound pressures at one-meter bystander position.)

### Power Requirements

Source: 100, 120, 220, 240V, ±10%

Frequency: 47.5-66 Hz

Consumption: less than 80W maximum

### Physical Specifications

#### HP DraftPro

Size: 1,030H x 1,140W x 520mmD (40.6" x 44.9" x 20.5")

Weight: net, 30kg (66lb); shipping, 45kg (100lb)

#### HP DraftPro DXL

Size: 1,105H x 1,145W x 570mmD (43.5" x 45" x 22.5")

Weight: net, 34kg (76lb); shipping, 54kg (120lb)

#### HP DraftPro EXL

Size: 1,210H x 1,450W 620mmD (47.5" x 57" x 24.5")

Weight: net, 41kg (91lb); shipping, 61kg (135lb)

### Certifications

FCC certified, Class B; meets or exceeds IEC-380, IEC-435, VDE 0806/08.81, UL-478, and CSA C22.2 No. 220.

### Accessories Supplied

User's Guide

Power cord (appropriate to plotter destination)

Media sample kit

5 sheets of metric A1-size paper (594 x 841 mm)

Fiber-tip pens (0.3 mm)

Package of 5 (black, blue, green, red, and yellow)

HP SurePlot disposable drafting pens (0.35 mm)

Package of 4 (black, blue, red, and green)

Carousels

Fiber-tip pen carousel

Drafting pen carousel

Grit wheel brush

Supplies catalog

### Ordering Information

HP 7570A DraftPro plotter

HP 7575A DraftPro DXL plotter

HP 7576A DraftPro EXL plotter

### Price

\$3,995

\$4,995

\$6,495

### Accessories Available

**Description HP 07570-90001** HP DraftPro Programmer's Reference

Manual (English only)

**HP 07575-90001** HP DraftPro DXL/EXL Programmer's Reference Manual

**HP 07570-90000** HP DraftPro Hardware Support Manual

**HP 07575-90000** HP DraftPro DXL/EXL Hardware Support Manual

**HP 17570A** HP-IB Interface Cartridge

**HP 17571A** HP-IB Interface Cartridge with Kanji

**HP 17573A** One-Megabyte plug-in buffer (for DraftPro DXL and EXL)<sup>2</sup>

**HP 17574A** Two-Megabyte plug-in buffer (for DraftPro DXL and EXL)<sup>2</sup>

<sup>1</sup> HP DraftPro DXL and EXL only. Data not available for HP DraftPro.

<sup>2</sup> Cannot be used with HP-IB interface.

# COMPUTER PERIPHERALS

## Plotters - High Performance, A4/A through AO/E size Drafting Plotters

### HP DraftMaster Series

- Exceptional performance
- Superior line quality
- HP-GL/2 plus HP-GL emulation
- Restart and multiple copy capabilities
- HP DraftMaster SX, RX: 1 Mbyte buffer
- HP DraftMaster MX: 20 Mbyte spooler

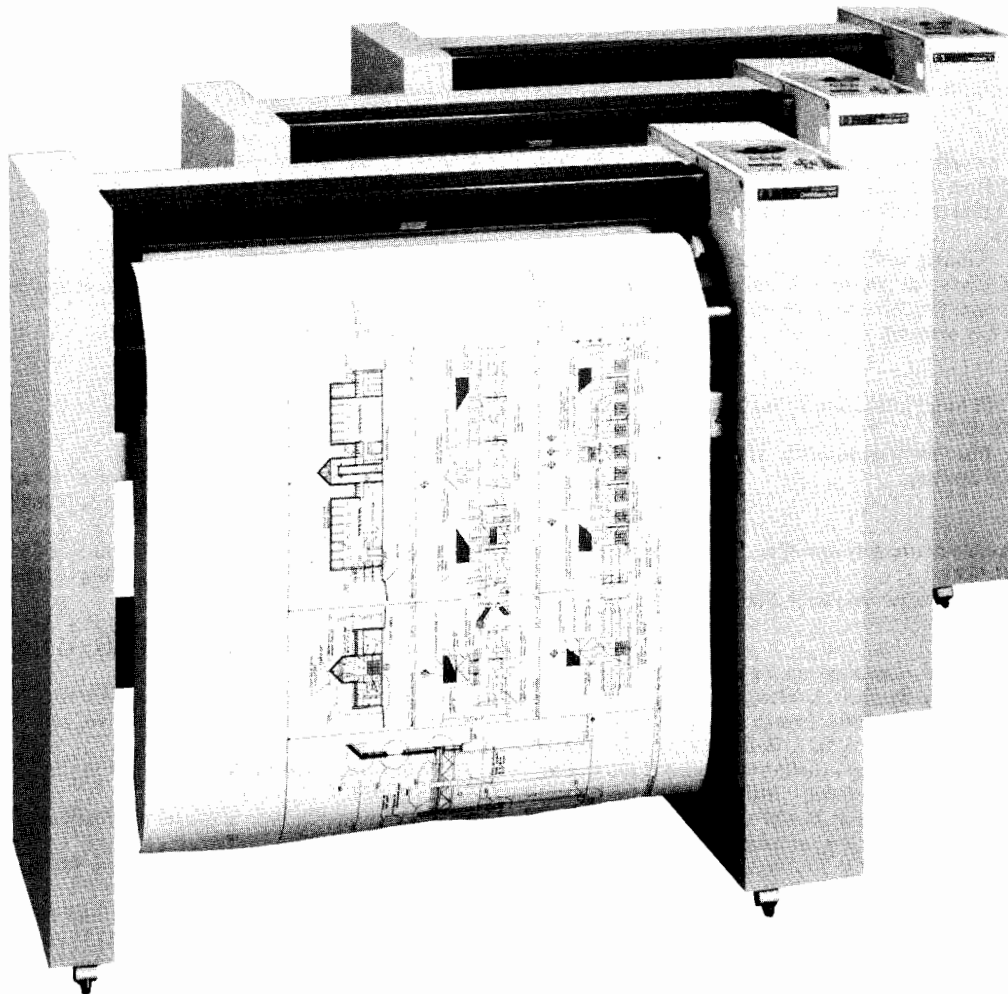

### HP DraftMaster Series Large-Format Pen Plotters

Hewlett-Packard has created a complete series of pen plotters following in the HP DraftMaster tradition of quality and performance. HP DraftMaster SX, HP DraftMaster RX, and HP DraftMaster MX are built for durability and productivity. They can handle greater workloads with faster throughput in today's demanding CAD environments, especially if you share your plotter.

Expect superior line quality from these premier pen plotters with a mechanical resolution of 0.00625 mm (0.0002 in) and repeatability of 0.10 mm (0.004 in). HP DraftMaster Series plotters have a maximum acceleration of 5.7 g, and a maximum pen speed of 110 cm/s (43 in/s), so you can spend more time working and less time waiting for plots. HP DraftMaster's unique combination of built-in features were specifically designed to increase personal productivity within your work group.

#### Three Models

##### HP DraftMaster SX

HP DraftMaster SX is engineered for reliable, high-quality, single-sheet plotting. The DraftMaster SX handles A- through E-size widths, up to 1.6 m (5.25 ft) in length. The standard 1 Mbyte buffer allows downloading of an entire plot, minimizing data transmission time and freeing the computer more quickly for another plot or task.

##### HP DraftMaster RX

In addition to all of the features currently available on HP DraftMaster SX, HP DraftMaster RX offers convenient media handling capabilities, including roll feed and take-up reel, plus long-axis plotting up to 45.72 m (150 ft). This pen plotter is the ideal choice for sharing through a central computer or LAN (local-area network) server.

##### HP DraftMaster MX

HP DraftMaster MX is HP's most advanced pen plotter. It has every feature and capability of HP DraftMaster RX plus multiuser interface for up to four users, a 20 Mbyte intelligent plot spooler, and superior plot management features.

Four RS-232-C ports make HP DraftMaster MX an easily shared plotter for non-networked PCs or workstations. Plot files from all four PCs or workstations can be transmitted directly to the plotter without a switch/buffer box. In addition, individual setups are available for each user.

The 20 Mbyte intelligent spooler (hard disk drive) acts as a huge buffer, so multiple files from multiple users can be downloaded, stored in a queue, and plotted as required. Queue status can be reviewed and changed as needed.

A single HP-IB port is also available to speed data transmission from HP workstations.

## HP-GL/2

All HP DraftMaster Series plotters implement HP-GL/2, Hewlett-Packard's new standard graphics language. HP-GL/2's improved language efficiency substantially reduces transmission time, so you and your computer can go on to another task quickly. In addition to increasing productivity today, it ensures consistency between plotters and software in the future. To get the most from your plotter, HP recommends using an efficient HP-GL/2 driver.

HP DraftMaster Series pen plotters also have a variety of intelligent firmware features that make plot management fast and convenient. The restart function lets you redraw your current plot without file retransmission. You can use the copy function to produce multiple copies without file retransmission. This is especially useful for producing multiple color originals.

## Improved Pens

HP SurePlot disposable drafting pens provide the quality and dependability required for optimum productivity. HP SurePlot disposable drafting pens have a ceramic tip for clog-free plotting. The specially designed regulator makes them leak-free, too. HP SurePlot pens are convenient and easy to use, with no assembly or maintenance required.

You can also choose from HP's complete range of fiber-tip, rollerball, and refillable drafting pens.

## Upgrade Kits

The HP DraftMaster Series upgrade kits provide a path for your future needs. HP p/n 17520A converts the HP DraftMaster SX to roll feed; HP p/n 17569A converts an HP DraftMaster RX into an HP DraftMaster MX.

## Reliability and Service

HP DraftMaster Series pen plotters, like all Hewlett-Packard products, have been tested extensively to ensure their quality and reliability. HP backs all its plotters with a standard one-year on-site warranty, and has the most affordable on-site service contracts in the industry.

## Technical Information

**Media sizes:** ranges include ISO sizes A4 through AO, ANSI sizes A through E, plus architectural sizes and oversized media. DraftMaster SX (sheets only); acceptable media widths; 207.0-381.0 mm (8.15-15.0 in), 539.0-713.0 mm (21.22-28.07 in), 753.0-927.0 mm (29.65-36.5 in). DraftMaster RX and MX; same sheet sizes as above plus these roll sizes, width 609.6 mm (24.0 in), 914.4 mm (36.0 in), length, 46.0 mm (1.50 ft).

**Margins (sheets only):** normal mode; three margins approx. 15.0 mm (0.59 in) each, fourth margin approximately 39.0 mm (1.54 in). Expanded mode; three margins approx. 5.0 mm (0.2 in) each, fourth margin approximately 29.0 mm (1.14 in).

**Resolution:** addressable; 0.025 mm (0.00098 in), mechanical; 0.00625 mm (0.0002 in).

**Repeatability (for a given pen):** 0.10 mm (0.004 in). (These specifications are for 0.08 mm (0.003 in) paper, vellum, or polyester film)

**Accuracy:** 0.09% of the move or 0.25 mm (0.01 in), whichever is greater. (These specifications are for 0.08 mm (0.003 in) polyester film.)

**Pen velocity:** Maximum pen speed<sup>1</sup>: 110 cm/s (43 in/s)

**Acceleration:** maximum, 5.7 g (55.5 m/s(2), 182.4 ft/s(2)) on diagonal, 4 g per axis; programmable, 2 or 4 g (19.4 or 39 m/s(2)).

**Pen force:** programmable or front panel selectable: 15-66 grams.

**Power requirements:** source, 100, 120, 220, 240 V,  $\pm 10\%$ ; frequency, 48-66 Hz; consumption for SX and RX, 125 W maximum; consumption for MX, 160 W maximum.

**Interfaces:** RS-232-C (including dual I/O for terminal eavesdrop), HP-IB, and RS-422-A. MX also allows four RS-232-C users to share.

**Buffer size:** SX and RX, 1 Mbyte RAM standard; MX, 20 Mbyte hard disk standard.

**Environmental ranges:** operating temperature, 0 to 55 degrees C (32 to 131 degrees F); storage temperature, -40 to 75 degrees C (-40 to 167 degrees F); humidity, sheets, 5 to 95% (0 to 40 degrees C); rolls, 30 to 70% (10 to 30 degrees C)

**Size:** 119.4 H x 134.6 W x 50.8 cm D (47" x 53" x 20.0")

**Weight:** Net, DraftMaster SX, 73 kg (160 lb); DraftMaster RX, 74 kg (164 lb); DraftMaster MX, 76 kg (167 lb). shipping, DraftMaster SX, 91 kg (200 lb); DraftMaster RX 93 kg (205 lb); DraftMaster MX, 94 kg (208 lb).

**Pens:** 8 in carousel; Fiber-tip (paper and transparency), long-body drafting (refillable or disposable), roller-ball.

**Media:** Vellum, double-matte polyester film, tracing bond, transparency film, paper (regular and glossy).

**Character sets, each in three fonts:** French/German, HP 9825, Scandinavian, Spanish/Latin American, Roman Extensions, Special Symbols, and these ISO registered sets: ANSI ASCII (006), French (025), French (069), German (021), International Reference Version (002), Italian (015), JIS ASCII (014), Katakana (013), Norwegian I (060), Norwegian II (061), Portuguese (016), Spanish (017), Swedish (010), Swedish for Names (011), United Kingdom (004).

<sup>1</sup> As in all pen plotters, actual pen speed depends on direction of travel, vector length, and maximum velocity setting.

## Accessories Included

User's guide (language appropriate to plotter destination), power cord (appropriate to plotter destination), paper sampler, adjustable pen carousels (2), fiber-tip pens (10), roller-ball pens (4), Disposable drafting pens for vellum with adapters (4), grit wheel brush, and plotter supplies catalog.

### Additional accessories included with HP DraftMaster RX and MX only

Paper roll sampler, 914.4 mm (36.0 in), wide, 13.72 m (45.0 ft) long, take-up spool, 914.4 mm (36.0 in), and media cutters (5).

**Additional accessories included with the HP DraftMaster MX**  
RS-232-C splitter cables (2) convert two DraftMaster ports into four.

## Ordering Information

	Price
HP 7595B DraftMaster SX large-format single-sheet drafting plotter	\$8,495
HP 7596B DraftMaster RX large-format roll-feed or sheet-feed drafting plotter	\$9,995
HP 7599A DraftMaster MX large-format multiuser roll-feed or sheet-feed drafting plotter	\$11,995

Note: Interface cables must be ordered separately.

# COMPUTER PERIPHERALS

## Plotters - Monochrome and Color Electrostatic Plotters

HP 7600 Series Models 250, 255, and 355

- 406 dpi resolution
- Monochrome plots in less than a minute; color plots in less than eight minutes
- Automatic cutter and take-up reel
- 64 shades of gray; over 2000 user-selectable colors
- Rasterizer with hard disk
- One-year on-site warranty

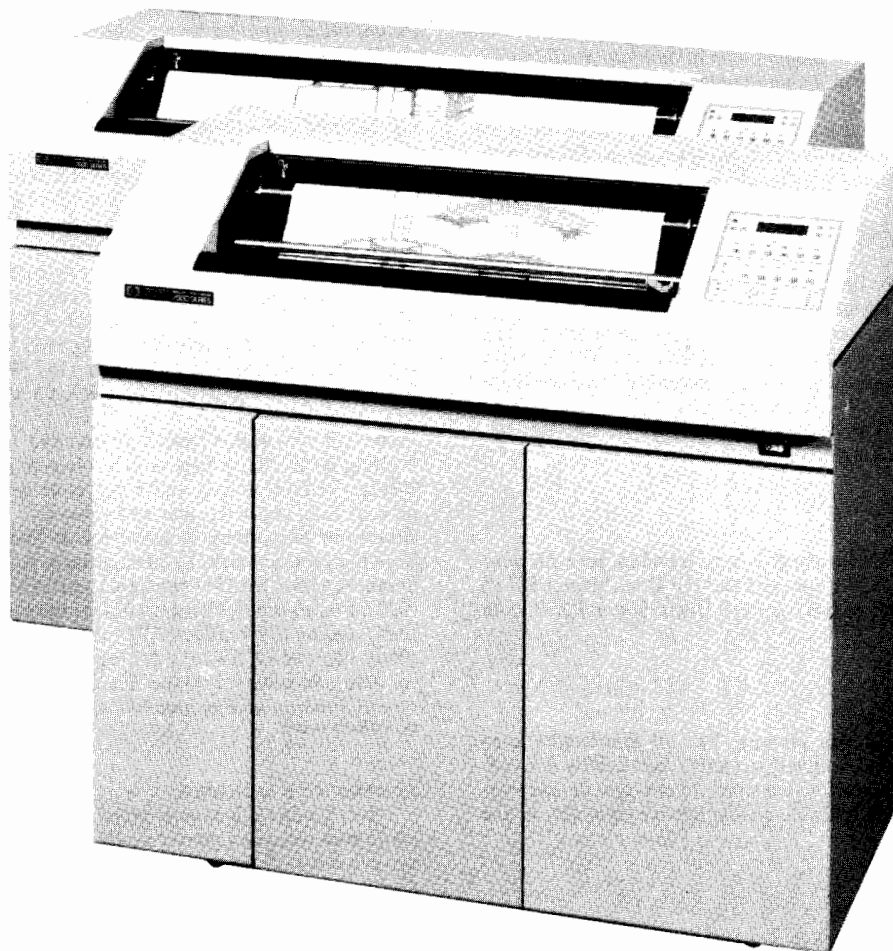

The HP 7600 Series electrostatic plotters offer a complete plotting solution for high-volume CAD environments. These plotters combine fast plotting speed with high-quality output to produce line drawings, complex plots, or shaded renderings for mapping, surveying, and mechanical, civil, and electrical engineering applications.

The HP 7600 Series Model 250 plotter plots on media 609 mm (24 in) wide; the Model 255 and Model 355 plot on media 914 mm (36 in) wide. All models can create long-axis plots up to 15.3 m (50 ft). One price includes the plotter, the rasterizer, installation by a qualified representative, and a one-year on-site warranty.

### High-productivity Plotting

Actual plotting time for typical final-quality, A0/E-size drawings is less than one minute plus data transmission time for monochrome plots, less than eight minutes plus data transmission time for color.

The rasterizer, built on the Motorola 68020 32-bit processor, and the 40-megabyte hard disk provide top performance, simultaneous rasterization and printing, and sophisticated plot management capabilities.

### Top-quality Output

The HP 7600 Series plotters have a resolution of 406 dots per inch — the high resolution needed for final-quality drawings.

HP toner has been carefully formulated for maximum plot density and durability. The media set includes paper, vellum, translucent, and clear and matte film, to meet all of your plotting needs: working copy, final plots, and archival drawings.

Five different palettes — four of which are user-definable — can be accessed from the front panel. Each palette consists of 256 logical pens and defines several attributes (type, width, and level of gray or color) for each logical pen. You can choose screened or patterned lines. When you have special plotting needs, you can use the mirror image or rotate features.

### Colors Plus Shades of Gray

The HP 7600 Series plotters can access a complete spectrum of colors and shades of gray for easy differentiation and smooth shading.

The HP 7600 Series Model 355 plotter uses dithering algorithms to combine black, cyan, magenta, and yellow toner to form hundreds of thousands of colors and shades, including 64 shades for each of the four toners. All these shades are accessible through software. When you define palettes from the front panel, you can select from a predefined set of over 2000 dithered colors.

The HP 7600 Series Models 250 and 255 can produce 64 different shades of gray, all of which are accessible from the front panel or through software.

### Complete Media Handling

With the standard automatic cutter and optional media stacker, you can neatly cut and stack drawings without operator intervention or manual cutting.

The built-in take-up reel handles a full media roll — 152.4 m (500 ft) for paper and 60.1 m (200 ft) for film — and is ideal for overnight or remote plotting. And a built-in manual cutter makes it simple to remove drawings from the take-up reel or separate long-axis plots.

### Front-panel Access to Advanced Features

You can define palettes, access up to five user setups, select plot modes, and manage the plotting queue, all from the front panel. The HP 7600 Series front panel has an easy-to-read 4 x 20 LCD, one-touch master menus, and a context-sensitive on-line help facility.

From the HP 7600 Series front panel, you can queue up plots, change priorities within the plotting queue, receive plots while plotting, or ask for copies of a plot already transmitted.

When you are doing several smaller drawings activate plot nesting to arrange the plots to minimize media usage.

### System Integration

Built on the industry-standard HP-GL command language, HP-GL/2 is Hewlett-Packard's new standard graphics language. It provides faster performance via a data compaction command plus simple software access to advanced features such as screened lines, plot scaling, and shading. Leading vendors of PC, workstation, and large system software are committed to providing support for HP-GL/2 plotters.

To take full advantage of the plotter's raster technology, the HP 7600 Series plotters support a PCL-based command set. The plotters accept raster input for plots up to A0/E-size and supports several raster compaction modes including CCITT Group 4.<sup>1</sup>

### HP 7586B Emulation

These HP 7600 Series plotters also have an HP 7586B emulation mode for HP-GL compatibility. When combined with features accessible from the front panel, you can use most software which supports an HP 7586B plotter.

### Traditional HP Reliability

The HP 7600 Series plotters meet the same stringent standards for quality and reliability that have made HP pen plotters leaders in the industry. They are based on the proven design of the HP 7600 Series Models 240D and 240E.

The HP 7600 Series plotters have been subjected to dozens of tests, including vibration, shock, and extreme temperature cycling. This testing ensures that you get reliable, consistent plotting. And we stand behind our reliability claim with a one-year on-site warranty and low service contract prices.

### Technical Information

**Media width:** Model 250, 609.6 mm (24 in); Model 255, 914.4 mm (36 in); Model 355, 914.4 mm (36 in)

**Plot width:** Model 250, 600.0 mm, ±2.4 mm (23.6 in, ±0.1 in); Model 255, 896.0 mm, ±3.6 mm (35.3 in, ±0.1 in); Model 355, 864.0 mm, ±3.6 mm (34 in, ±0.1 in)

<sup>1</sup> This is a special subset of graphics commands for use with the HP 7600 Series plotters. Raster input requires specific software support; a PCL driver written for an HP printer will not support these plotters.

**Toner capacity:** 5 liters (1.3 gal)

**Interfaces:** RS-232-C/CCITT V.24, HP-IB (IEEE 488-1978), and Centronics parallel

**Maximum print speed:** Model 250, 1.6 cm per second (0.64 in per second); Model 255, 2.3 cm per second (0.91 in per second); Model 355, 3.0 cm per second (1.18 in per second)

**Resolution:** 406 dpi

**Maximum accumulated error<sup>2</sup>:** ± 0.2%

**Pin electrodes:** configuration, dual array; diameter, 0.0060 cm (0.0024 in); spacing, 0.00625 cm (0.0025 in)

**Environmental ranges:** operating temperature, 10 to 20 degrees C (50 to 86 degrees F); storage temperature, -10 to 60 degrees C (14 to 140 degrees F); operating humidity, 30 to 80% RH<sup>3</sup>; storage humidity, 15 to 85% RH<sup>3</sup>

**Power requirements:** Model 250, Voltage requirements: source - 100, 120, 220, 240 VAC; frequency - 50-60 Hz; Consumption - 720 VA maximum; Model 255, Voltage requirements: source - 100, 120, 220, 240 VAC; frequency - 50-60 Hz; Consumption - 720 VA maximum; Model 355, Voltage: source - 100, 120, 220, 240 VAC; frequency - 50-60 Hz; Consumption - 800 VA maximum

**Size:** Model 250, 1030Hx1100Wx600mmD (40.55"x43.3"x23.6")

Model 255, 1030Hx1400Wx600mmD (40.55"x55.1"x23.6")

Model 355, 1030Hx1400Wx600mmD (40.55"x55.1"x23.6")

**Weight:** Model 250, plotter net weight, - 216 kg (475 lb); shipping weight - 229 kg (503.8 lb); rasterizer weight - 20 kg (44 lb); accessories - 20 kg (44 lb); Model 255, plotter net weight - 259 kg (569.8 lb), shipping weight - 272 kg (598.4 lb); rasterizer weight - 20 kg (44 lb); accessories - 25 kg (55 lb); Model 355, plotter net weight - 311 kg (684 lb), shipping weight - 307 kg (675 lb); rasterizer weight - 20 kg (44 lb); accessories - 20 kg (44 lb)

**Product certifications:** Models 250 and 255, safety approvals: UL listed, CSA certified, electromagnetic interference - FCC Class A verified, VCCI-1 Model 355, safety approvals: CSA certified, UL listed, complies with EN 60 950/09.87, GS(TUV) approved, NEMKO approved; electromagnetic interference - FCC Verified Class B, meets VDE 0871-B (FTZ 1046/84), SABS approved

### Ordering Information

HP Part No. Description	Price
<b>C1625A HP 7600 Series Model 250</b> 24-inch monochrome electrostatic plotter	\$25,900
<b>C1627A HP 7600 Series Model 255</b> 36-inch monochrome electrostatic plotter	\$29,900
<b>C1620A HP 7600 Series Model 355</b> 36-inch color electrostatic plotter	\$45,900
<b>C1644A Media Stacker</b>	\$200

Note: Interface cables must be ordered separately.

### Accessories Included

User's guide, power cord, premium grade paper (one roll), pre-mixed liquid toners, pre-moistened cleaning wipes, writing head polish, dry cleaning wipes, handheld media cutting knife, manual media cutter, take-up reel spindle, and media stacker (Model 355 only).

<sup>2</sup> At 23 degrees C (73 degrees F), 50 to 60% RH with HP approved polyester film.

<sup>3</sup> Non-condensing (Note: Never operate the plotter in the presence of condensation; it will cause damage to the writing head.)



# COMPUTER PERIPHERALS

**Furniture**  
**Design Plus**

- Furniture that fits your Hewlett-Packard system like a glove.

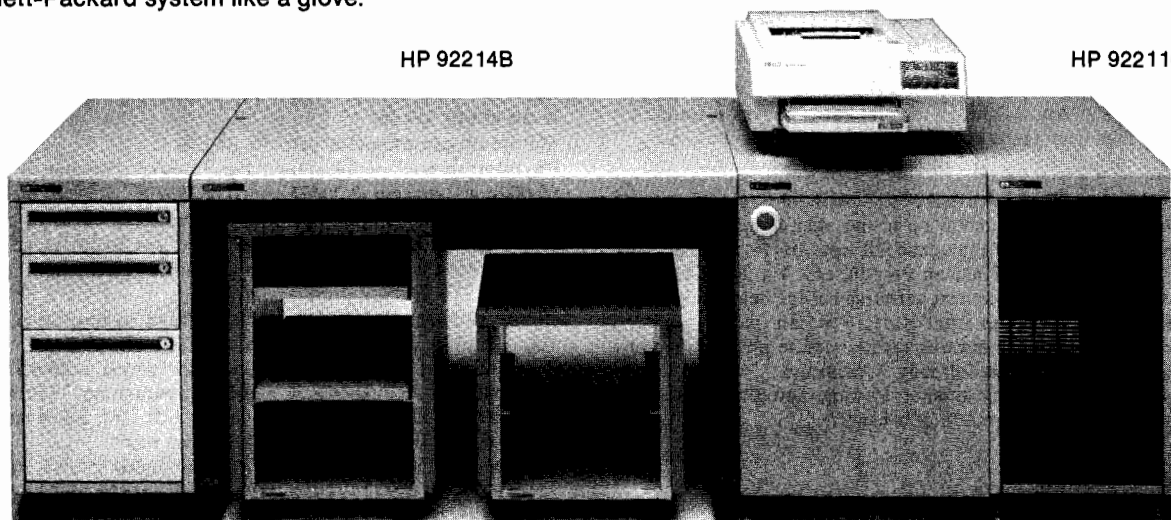

HP 92211N

HP 92211L

HP 92211M

HP 92211D

Shown from left to right: Mobile Drawer Unit, System Table with Mobile Support Cabinet tucked underneath, Mobile LaserJet Cabinet and Mini-Rack Cabinet. For complete details, see chart on the next page.

## Design Plus

Design Plus fits HP computers and peripherals perfectly, becoming an integral part of your total computer solution.

It's constructed of the highest quality materials. Die-cast metal legs withstand the weight of your equipment and the pressure of normal office moves, without danger of buckling or breaking. Matte surfaces resist scratches and stains, while protecting your eyes from the glare of overhead lighting.

## Mini-Rack Cabinet

Designed to hold the CPU and disc drive of your HP 9000 Series 200, 300 or 500 computer, also the HP 3000 Series 37, HP 260 or MICRO 3000. It matches the height and depth of our tables and can be locked into place. This results in additional work surface, flush-fitted and without troublesome gaps or height discrepancies.

## Mobile Drawer Units

Store your files, documentation and other valuables. These units match the height of our tables exactly.

## Mobile Support Cabinets

Storage for hard-disc drives and tape back-up systems that fit conveniently under our tables.

## Mobile Sound Enclosure Cabinet

Choose this cabinet for HP serial impact dot matrix printers.

## Universal Support Stand

Printers and small plotters are supported, and rolled about easily on self-locking casters.

### HP Ergonomic executive chair with arm support

HP Part no	Color	Seat	Chair back	Price
92208M	Gray	Height 16.25-19 in (413-483 mm)	Height 18-20.25 in (457-514 mm)	(1-2).....\$475.00 ea.
92208N	Blue	Depth 18 in (457 mm)	Width 17.5 in (445 mm)	(3+)..... 440.00 ea.
92208P	Beige	Width 19 in (483 mm)		

### HP Ergonomic workstation/managerial chair











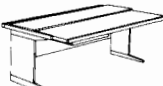
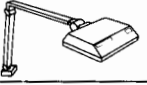

HP Part no	Color	Seat	Chair back	Price
92208E	Gray	Height 16.25-20.75 in (413-527 mm)	Height 10.50-15.50 in (267-394 mm)	(1-2).....\$245.00 ea.
92208F	Blue	Depth 18 in (457 mm)	Width 16 in (406 mm)	(3+)..... 225.00 ea.
92208G	Beige	Width 18.50 in (470 mm)		
92208K	Dk Brown	Arm set		(1-2)..... 79.00 ea.
				(3+)..... 69.00 ea.

### HP Ergonomic workbench chair

HP Part no	Color	Seat	Chair back	Price
92208S	Blue	Height 19-25.50 in (483-648 mm)	Height 10.50-15.50 in (267-394 mm)	(1-2).....\$365.00 ea.
		Depth 18 in (457 mm)	Width 16 in (406 mm)	(3+)..... 340.00 ea.
92208Q		Cylinder for 92208M/N/P		
92208H		Cylinder for 92208E/F/G		
92208L	Dk Brown	Caster set/5 per set		
92208U		Cylinder for 92208S		

Replacement parts may be ordered from your local HP sales and service office or contact HP Support and Materials Organization at 1-800-227-8164.

☎ For same-day shipment, call HP DIRECT at 800-538-8787

HP Part number	Description	Height	Width	Depth	Price
92214A	<i>Design Plus</i> Mobile terminal support and transport system table. Designed to safely move terminals and small systems.	28.4 in (720 mm)	29.5 in (750 mm)	28.0 in (711 mm)	(1-2 tables).....\$475 ea. (3+) ..... 445 ea.
92214B	Medium <i>Design Plus</i> System table. Comes with cable management, locking casters, and is same height as 92211R mobile rack system cabinet.	28.4 in (720 mm)	44.3 in (1125 mm)	28.0 in (711 mm)	(1-2 tables).....\$525 ea. (3+) ..... 495 ea.
92214C	Large <i>Design Plus</i> System table. Comes with cable management, adjustable leveling glides, and is same height as 92211R mobile rack system cabinet.	28.4 in (720 mm)	59.0 in (1500 mm)	28.0 in (711 mm)	(1-2 tables).....\$585 ea. (3+) ..... 545 ea.
 92213B	<i>Design Plus</i> CAD Mini-workstation. For use with the HP 9000 Series 300/500 computers. Comes with 14.25-in (362 mm) wide raised monitor platform, pull-out work surface that extends to 36-in (914 mm) deep, pull-out keyboard drawer and cable management. Same height as 92211R mobile mini-rack; 92211L/M fits underneath.	28.4 in (720 mm)	44.3 in (1125 mm)	28.0 in (711 mm)	(1-2 units).....\$849 ea. (3+) ..... 799 ea.
 92213F	<i>Design Plus</i> CAD workstation is designed for use with HP CAD systems. It comes with a pull-out work surface, keyboard drawer, raised monitor platform and cable management. It attaches to other <i>Design Plus</i> Furniture.	28.4 in (720 mm)	59.0 in (1500 mm)	28.0 in (711 mm)	(1-2 tables).....\$899 ea. (3+) ..... 849 ea.
 92213Q	<i>Design Plus</i> ergonomic task lamp. Specifically designed for computer workstations. Two nine-watt emitters produce the same light as 80-watts incandescent. Lamp stem fits <i>Design Plus</i> tables. UL listed and CSA approved.	N/A	N/A	N/A	(1-2 units).....\$280 ea. (3+) ..... 260 ea.
 92213R	<i>Design Plus</i> clamp. Designed for the <i>Design Plus</i> lamp (92213Q.) For use on non- <i>Design Plus</i> table tops. Maximum clamp opening is 5 inches, (127 mm.) Use this clamp for HP standard tables.	N/A	N/A	N/A	(1-2 units).....\$28 ea. (3+) ..... 26 ea.
92213D	"C" and "D" sized drawing holder. Mounts to workstation and system tables. Two-section arm for height and tilt position extends from 13.0 in (330 mm) to 22.25 in (565 mm).	20.0 in (508 mm)	30.0 in (762 mm)	2.6 in (6 mm)	(1-2 units).....\$219 ea. (3+) ..... 199 ea.
 92214J	90-degree <i>Design Plus</i> Corner turn. Used for joining two system tables together for a larger work area. <b>NOTE:</b> not intended to support CAD monitors.	Each side	28.0 in (711 mm)		(1-2 units).....\$295 ea. (3+) ..... 270 ea.
 92214K	<i>Design Plus</i> CAD corner workstation. Perfectly fitted for use with HP CAD systems. Workstation comes with a keyboard drawer and cable management. It can be joined to <i>Design Plus</i> furniture.	28.4 in (720 mm)	44.3 in (1125 mm)	44.3 in (1125 mm)	(1-2 tables).....\$899 ea. (3+) ..... 849 ea.
 92211U	<i>Design Plus</i> joining bracket kit. For use on all <i>Design Plus</i> furniture pieces to anchor one to another. Comes with needed screws and instructions for assembly and use.	N/A	N/A	N/A	(1-2 units).....\$40 ea. (3+) ..... 37 ea.
92211C	<i>Design Plus</i> Mobile sound enclosure cabinet. For use with all 293X serial impact dot matrix printers.	28.4 in (720 mm)	29.5 in (750 mm)	19.7 in (500 mm)	(1 unit).....\$585 ea. (3+) ..... 545 ea.
 92211L	<i>Design Plus</i> Mobile support cabinet. Rolls easily under the 92214B/C <i>Design Plus</i> system tables. Can be used as a stand-alone system cabinet for the HP 9000 Series 200/300/500, has open back. Comes with two sets of mounting rails, a cable routing kit (92199F), and two storage shelves. Internal dimensions are 12.8 in (325 mm) wide x 20.40 in (520 mm) high.	24.4 in (620 mm)	16.7 in (425 mm)	20.7 in (525 mm)	(1-2 units).....\$310 ea. (3-9) ..... 290 ea. (10+) ..... 270 ea.
 92211M	<i>Design Plus</i> small Mobile support cabinet. Rolls easily under the 92214B/C <i>Design Plus</i> system tables. Can be used as a stand-alone system cabinet for the Series 200, Model 237 or 300. Comes with one set of mounting rails, a cable routing kit (922199F), and a pad to put under the Model 237. Internal dimensions are 12.8 in (325 mm) wide x 13.26 in (338 mm) high.	17.1 in (435 mm)	16.7 in (425 mm)	16.7 in (425 mm)	(1-2 units).....\$250 ea. (3-9) ..... 230 ea. (10+) ..... 210 ea.
 92211N	<i>Design Plus</i> Mobile drawer unit. Rolls easily and sits next to all <i>Design Plus</i> system tables (also same height as tables). Comes with three drawers, 4 in, 6 in and 12 in (104 mm, 156 mm, and 312 mm).	28.4 in (720 mm)	14.8 in (375 mm)	28.0 in (711 mm)	(1-2 units).....\$745 ea. (3-9) ..... 705 ea. (10+) ..... 665 ea.
 92211R	<i>Design Plus</i> Mobile mini-rack system cabinet for HP modular peripherals and systems. Comes fully assembled with casters. Back opens for easy access. Accessories available are the 92211S mounting rail and module lock kit, 92211T filler panel kit, and 92199B power strip. Internal dimensions are 12.8 in (325 mm) wide x 22.44 in (572 mm) high.	28.4 in (720 mm)	14.8 in (375 mm)	28.0 in (711 mm)	(1-2 racks).....\$585 ea. (3-9) ..... 550 ea. (10+) ..... 515 ea.
92211E	Small (4 inch) drawer unit for 92211R Mobile mini-rack system cabinet.	4 in (102 mm)	12.75 in (324 mm)	18.62 in (473 mm)	(1-2 units).....\$139 ea. (3+) ..... 129 ea.
92211F	Medium (6 inch) drawer unit for 92211R Mobile mini-rack system cabinet.	6 in (152 mm)	12.75 in (324 mm)	18.62 in (473 mm)	(1-2 units).....\$149 ea. (3+) ..... 139 ea.
92211G	Large (12 inch) drawer unit for 92211R Mobile mini-rack system cabinet.	12 in (305 mm)	12.75 in (324 mm)	18.62 in (473 mm)	(1-2 units).....\$159 ea. (3+) ..... 149 ea.
 92211S	Rail kit for 92211R Mobile mini-rack cabinet. Comes with four sets of rails and module locks. Used to mount up to four HP computer and peripheral equipment modules.			Rail length—25.1 in (638mm)	(1-2 kits).....\$50 ea. (3-9) ..... 45 ea. (10+) ..... 40 ea.
 92211T	Filler panel kit for 92211R mobile mini-rack cabinet. Kit contains 20 snap-in panels used to fill empty space not occupied by computer equipment modules.	0.9 in (23 mm)	12.8 in (325 mm)	0.9 in (23 mm)	(1-2 kits).....\$40 ea. (3-9) ..... 35 ea. (10+) ..... 30 ea.
 92214P	<i>Design Plus</i> Universal support stand. For use with HP LaserJet, HP 2932/33/34, HP 2563A printers and small HP plotters. Comes with printout catcher shelf, casters and leveling glides. Has slot in top for bottom feeding and slot in door top for front feeding. Also has sound control pad.	28.4 in (720 mm)	23.6 in (600 mm)	17.7 in (450 mm)	(1-2 units).....\$295 ea. (3+) ..... 265 ea.
92211D	<i>Design Plus</i> Mobile LaserJet Printer cabinet. Comes fully assembled with a storage shelf for paper trays and space for toner cartridges and other supplies.	28.3 in (720 mm)	20.0 in (508 mm)	28.0 in (711 mm)	(1-2 units).....\$385 ea. (3+) ..... 365 ea.

# COMPUTER PERIPHERALS

## Furniture HP Standard Furniture

- Solid, Expandable, Economical

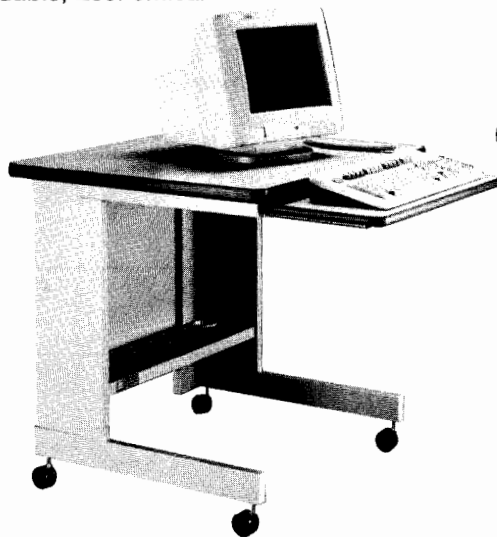

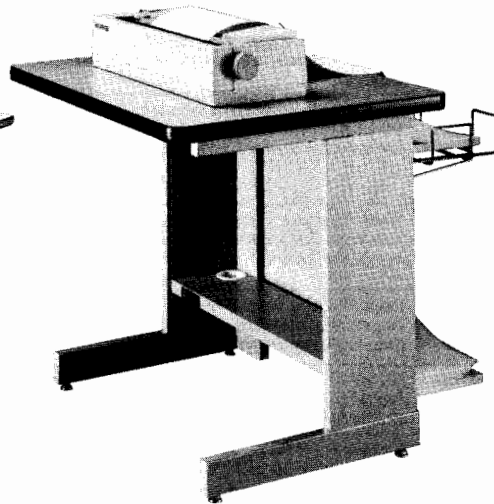

HP 92210T Mobile workstation table

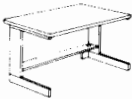
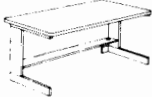
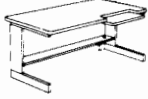
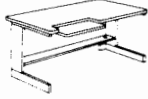

HP 92210P Printer stand

### HP Standard furniture

	HP Part number	Description	Height	Width	Depth	Price
	HP 92210A	Compact workstation table, with leg levelers and modesty panel. 7-in (178 mm) shelf standard. See 92210L casters next page to adapt table height to 28.4 in (720 mm).	27.0 in (686 mm)	48.0 in (1220 mm)		(1-2 units).....\$325 ea. (3+)..... 305 ea.
	HP 92210B	Standard workstation table, with leg levelers and modesty panel. 7-in (178 mm) shelf standard. See 92210L casters next page to adapt table height to 28.4 in (720 mm).	27.0 in (686 mm)	60.0 in (1524 mm)	30.0 in (762 mm)	(1-2 units).....\$380 ea. (3+)..... 360 ea.
	HP 92210C	Workstation table with right-hand adjustable keyboard section. Leg levelers, modesty panel and 7-in (178 mm) shelf standard. Keyboard section starts 3 in (76 mm) from the right side, adjusts down a total of 2.1 in (53 mm) from table top and can be tilted 10 degrees from the horizontal. Manual adjustments. See 92210L casters next page to adapt table height to 28.4 in (720 mm).	29.0 in (736 mm)	60.0 in (1524 mm)	30.0 in (762 mm)	(1-2 units).....\$455 ea. (3+)..... 405 ea.
	HP 92210D	Workstation table with left-hand adjustable keyboard section. Leg levelers, modesty panel and 7-in (178 mm) shelf standard. Keyboard section starts 3 in (76 mm) from the left side, adjusts down a total of 2.1 in (53 mm) from the table top and can be tilted 10 degrees from the horizontal. Manual adjustments. See 92210L casters next page to adapt table height to 28.4 in (720 mm).	29.0 in (736 mm)	60.0 in (1524 mm)	30.0 in (762 mm)	(1-2 units).....\$445 ea. (3+)..... 405 ea.
	HP 92210U	The standard CAD corner workstation is perfectly fitted for use with HP CAD systems. Workstation comes with a keyboard drawer. Part of the HP standard furniture line.	29 in (736 mm)	45 in (1143 mm)	45 in (1143 mm)	(1-2 tables).....\$599 ea. (3+)..... 559 ea.
	HP 92210V	Workstation tabletop connector. 90-degree triangle. Joins two 92210A/B/C/D tables together.	Each side	30.0 in (763 mm)		(1-2 units).....\$155 ea. (3+)..... 145 ea.















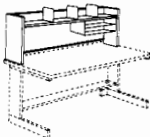



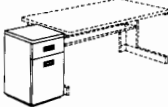

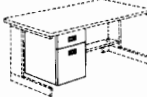

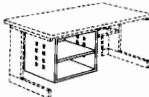

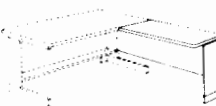
# COMPUTER PERIPHERALS

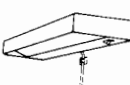
Furniture

HP Standard Furniture

705

## HP Standard furniture (continued)

	HP Part number	Description	Height	Width	Depth	Price	
	92210F	Desktop storage shelf for <b>92210A</b> workstation table. Includes two book supports and back-wall message board. 11 in (279 mm) storage shelf adjusts from 15 in (381 mm) to 21 in (533 mm) above work surface of table. Convenient paper/storage shelf included.	23.0 in (584 mm)	47.0 in (1194 mm)	12.0 in (305 mm)	(1-2 units) .....\$265 ea. (3+) ..... 245 ea.	
	92210G	Desktop storage shelf for <b>92210B/C/D</b> workstation table. Includes three book supports and back-wall message board. 11 in (279 mm) storage shelf adjusts from 15 in (381 mm) to 21 in (533 mm) above work surface of table. Convenient paper/storage shelf included.	23.0 in (584 mm)	59.0 in (1499 mm)	12.0 in (305 mm)	(1-2 units) .....\$285 ea. (3+) ..... 265 ea.	
	92210Z	Newly revised desktop wide-flipper door storage unit for <b>92210B/C/D</b> workstation table. Includes lockable flipper door and back-wall fabric-covered message board. Space from table top to shelf bottom is 19.5 in (495 mm).	34.0 in (864 mm)	59.0 in (1499 mm)	14.0 in (356 mm)	(1-2 units) .....\$495 ea. (3+) ..... 455 ea.	
	92210N	Mobile drawer unit, on casters. Two drawers, with identical key lock all units. Deep bottom drawer like <b>92210Q</b> below. Unit rolls easily to any workstation; top same height as <b>92210A/B</b> .	27.0 in (686 mm)	15.4 in (391 mm)	20.0 in (508 mm)	(1-2 units) .....\$335 ea. (3+) ..... 305 ea.	
	92210Q	Suspended drawer unit. Two drawers, with identical key lock units. Deep bottom drawer can store three types of hanging files: letter-size, legal-size, and computer printout binders. Fits right or left side of <b>92210A/B/C/D</b> tables.	21.0 in (533 mm)	14.8 in (375 mm)	19.4 in (493 mm)	(1-2 units) .....\$245 ea. (3+) ..... 225 ea.	
	92210R	Storage module unit, with three-position adjustable shelf. Rear of module is open for ventilation and access to <b>92210A/B/C/D</b> cable management system, when module used to hold electronic equipment. Fits right or left side of <b>92210A/B/C/D</b> tables.	19.0 in (483 mm)	21.0 in (534 mm)	19.4 in (493 mm)	(1-2 units) .....\$115 ea. (3+) ..... 105 ea.	
			<b>Inside module dimensions</b>				
			17.0 in (432 mm)	19.4 in (493 mm)	19.4 in (493 mm)		
	92210E	Work surface extension (return), with leg levelers and modesty panel. Fits right or left side of <b>92210B</b> table, left side of <b>92210C</b> , right side of <b>92210D</b> . Requires use of 'Z' bracket (included) when mounting on <b>92210C/D</b> . <b>Not for 92210A</b> .	27.0 in (686 mm)	40.0 in (1016 mm)	24.0 in (610 mm)	(1-2 units) .....\$235 ea. (3+) ..... 215 ea.	
	92210W	Task light unit. Screws into place underneath the <b>92210F/G/Z</b> desktop storage units. Includes 20-watt fluorescent bulb, lens and power cord wire management clips. UL listed and CSA approved.	2.0 in (50.8 mm)	24.0 in (610 mm)	6.6 in (168 mm)	(1-2 units) .....\$119 ea. (3+) ..... 109 ea.	
	92210P (see photo previous page)	Printer stand. Design matches HP 92210 series workstation system. Convenient paper feed slot (4 x 19 in, 102 x 483 mm) in top allows bottom paper feed. Also features rear printout catcher with 1.5-in (38 mm) slot to allow paper transport to rear feed printers. Cable management slots, 7-in shelf standard.	27 in (686 mm)	30 in (762 mm)	24 in (610 mm)	(1-2 units) .....\$285 ea. (3+) ..... 265 ea.	
			18.5 in (470 mm)	17 in (432 mm)	13.5 in (343 mm)		
	92210T (see photo previous page)	Mobile workstation table for terminals. Design matches HP 92210 series workstation system. Features a dropped, pull-out keyboard surface. Cable management slots, locking casters and 7-in (178 mm) shelf standard.	28.3 in (720 mm)	30 in (762 mm)	28 in (712 mm)	(1-2 units) .....\$330 ea. (3+) ..... 305 ea.	
			26.4 in (670 mm)	23.5 in (597 mm)	12 in (305 mm)		
	92210L	Set of four heavy-duty, double-wheel casters. Use in place of leg levelers on <b>92210A/B/C/D</b> tables or <b>92210P</b> stand where mobility is desired. Caster height 1.75 in (45 mm). Adapts height of tables to 28.4 in (720 mm).					

Replacement parts may be ordered from your local HP sales and service office or contact HP Support and Materials Organization at 1-800-227-8164.

 For same-day shipment, call HP DIRECT at 800-538-8787

# CABLES & ADAPTERS

Cables, Adapters & Typical SWR Performance

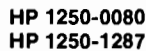
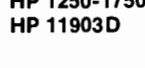
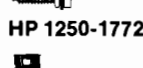
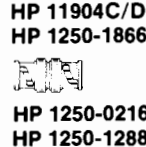
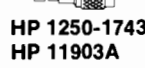
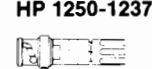
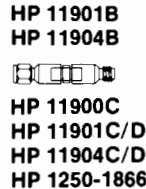
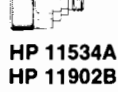
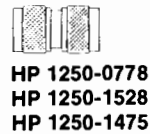
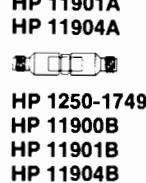
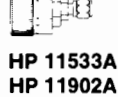
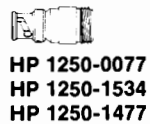
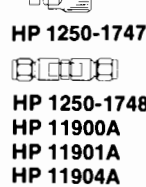
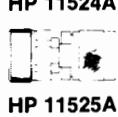
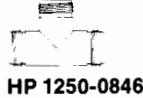
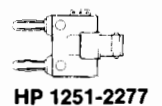
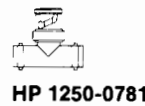
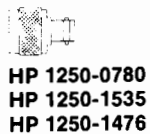
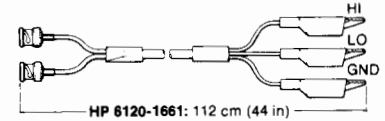
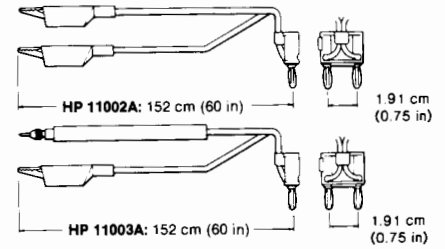
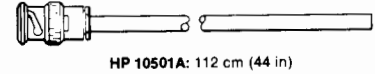
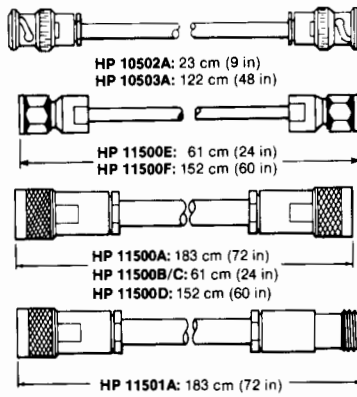
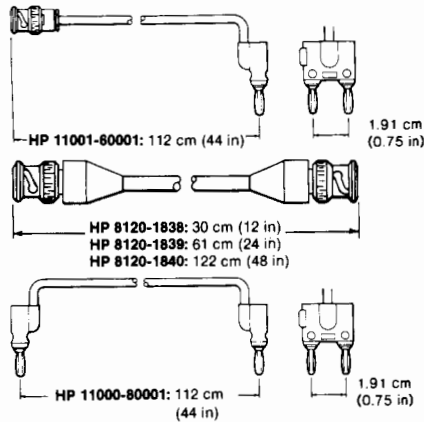

Some part numbers are not pictured.

## Coaxial Connector & Adapter Performance

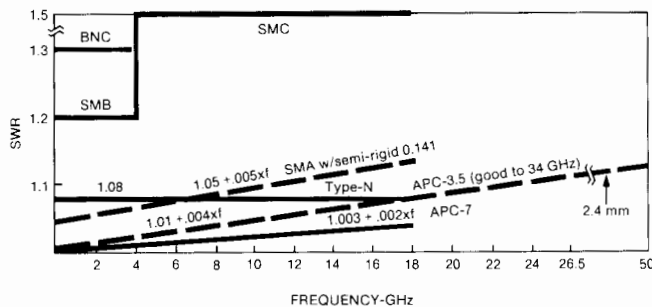

Typical SWR for connector pairs.

The performance curves in the graph will help you in choosing and applying HP cables, connectors and adapters. SWR curves show design specifications for mated pairs of connectors of the type indicated. You can expect typical performance in that range.

For cross-series adapters, use the curve with the highest SWR in each case. For applications of Tee-adapters such as HP 1250-0559, 1250-0846 and 1250-0781, be sure to consider the extra shunt capacitance of the Tee.

Of course when HP mounts various connectors onto RF and microwave products, the product specification predominates and SWR is often far superior to that shown in these utility curves. For example, the HP "precision" Type-N adapters shown on these pages are for high accuracy use dc-1.3 GHz where SWR < 1.03.

For more information on history and performance of various coax connectors, see HP's *Coaxial & Waveguide Measurement Accessories Catalog*. (Lit # 5954-6401).

# CABLES & ADAPTERS

Cables & Adapters

Ordering Information

707

HP Part Number	Price
<b>Cable Assemblies</b>	
HP 10501A: 112 cm 50Ω coax with one UG-88C/U BNC (m) connector	\$37.50
HP 10502A: 23 cm 50Ω coax with UG-88C/U BNC (m) connectors	\$32.50
HP 10503A: like HP 10502A, but 122 cm	\$35.00
HP 8120-1838: 30 cm 50Ω coax with two BNC (m) connectors	\$19.50
HP 8120-1839: like HP 8120-1838, but 61 cm	\$20.00
HP 8120-1840: like HP 8120-1838, but 122 cm	\$23.50
HP 11000-60001: 112 cm 50Ω coax with dual banana plugs	\$30.00
HP 11001-60001: 112 cm 50Ω coax, UG-88C/U BNC (m) to dual banana plug	\$30.00
HP 11002A Test Leads: 152 cm, alligator clips to dual banana plug	\$21.00
HP 11003A Test Leads: 152 cm, probe and alligator clip to dual banana plug	\$21.00
HP 8120-1661: 112 cm, dual BNC (m) to alligator clips	\$90.00

HP Model	Frequency Range (GHz)	Length cm (in)	Connectors	SWR	Ins. Loss (dB)	Price
11500A	dc - 12.4	183 (72)	N(m) (2)	—	—	\$110
11500B	dc - 12.4	61 (24)	N(m) (2)	—	—	110
11501A	dc - 18	183 (72)	N(m)-N(f)	—	—	110
11500C	dc - 18	61 (24)	Precision N(m) (2)	1.4	1.5	625
11500D	dc - 18	152 (60)	Precision N(m) (2)	1.4	3.0	700
11500E	dc - 26.5	61 (24)	APC-3.5 (m) (2)	1.4	2.0	650
11500F	dc - 26.5	152 (60)	APC-3.5 (m) (2)	1.4	4.0	750

## Adapters, 2.4 mm

(See page 706 for technical description and performance)

11900A 2.4 mm (m) to 2.4 (m)	\$450.00
11900B 2.4 mm (f) to 2.4 (f)	\$450.00
11900C 2.4 mm (m) to 2.4 (f)	\$450.00
11901A 2.4 mm (m) to APC-3.5 (m)	\$375.00
11901B 2.4 mm (f) to APC-3.5 (f)	\$375.00
11901C 2.4 mm (m) to APC-3.5 (f)	\$375.00
11901D 2.4 mm (f) to APC-3.5 (m)	\$375.00
11902A 2.4 mm (m) to APC-7	\$425.00
11902B 2.4 mm (f) to APC-7	\$425.00
11903A 2.4 mm (m) to Type N (m)	\$450.00
11903B 2.4 mm (f) to Type N (f)	\$450.00
11903C 2.4 mm (m) to Type N (f)	\$450.00
11903D 2.4 mm (f) to Type N (m)	\$450.00
11904A 2.4 mm (m) to K (m) <sup>[5]</sup>	\$500.00
11904B 2.4 mm (f) to K (f) <sup>[5]</sup>	\$500.00
11904C 2.4 mm (m) to K (f)	\$500.00
11904D 2.4 mm (f) to K (m)	\$500.00

## Adapters Type N, Standard 50 Ω

1250-0077 N(f) to BNC(m)	\$13.25
1250-0082 N(m) to BNC(m)	\$14.75
1250-0176 N(m) to N(f) right angle (use < 12 GHz)	\$21.00
1250-0559 N tee, (m)(f)(f)	\$38.00
1250-0777 N(f) to N(f)	\$13.25
1250-0778 N(m) to N(m)	\$12.00
1250-0780 N(m) to BNC(f)	\$14.25
1250-0846 N tee (f)(f)(f)	\$20.25
1250-1250 N(m) to SMA(f)	\$35.00
1250-1562 N(f) to SMA(m)	\$67.50
1250-1636 N(m) to SMA(m)	\$130.00
1250-1772 N(f) to SMA(f)	\$72.50

## Adapters Type N, Precision 50 Ω<sup>[1]</sup>

1250-1472 N(f) to N(f)	\$45.00
1250-1473 N(m) to BNC(m)	\$45.00
1250-1474 N(f) to BNC(f)	\$30.00
1250-1475 N(m) to N(m)	\$60.00
1250-1476 N(m) to BNC(f)	\$41.00
1250-1477 N(f) to BNC(m)	\$35.00

## Adapters Type N, Standard 75 Ω<sup>[2]</sup>

1250-0597 N(m) (50Ω) to N(f)(75Ω)	\$30.00
1250-1528 N(m) to N(m)	\$60.00
1250-1529 N(f) to N(f)	\$40.00
1250-1533 N(m) to BNC(m)	\$41.00
1250-1534 N(f) to BNC(m)	\$40.00
1250-1535 N(m) to BNC(f)	\$42.00
1250-1536 N(f) to BNC(f)	\$38.00

HP Part Number	Price
<b>Adapters APC-3.5</b>	
1250-1743 APC-3.5(m) to N(m)	\$135.00
1250-1744 APC-3.5(f) to N(m)	\$165.00
1250-1745 APC-3.5(f) to N(f)	\$115.00
1250-1746 APC-3.5(m) to APC-7	\$150.00
1250-1747 APC-3.5(f) to APC-7	\$160.00
1250-1748 APC-3.5(m) to APC-3.5(m)	\$170.00
1250-1749 APC-3.5(f) to APC-3.5(f)	\$185.00
1250-1750 APC-3.5(m) to N(f)	\$135.00
1250-1866 APC-3.5(mm) to APC-3.5(f)	\$320.00
<b>Adapters SMA</b>	
1250-1158 SMA(f) to SMA(f)	\$18.00
1250-1159 SMA(m) to SMA(m)	\$18.50
1250-1249 SMA Right angle (m) (f)	\$32.00
1250-1397 SMA Right angle (m) (m)	\$40.00
1250-1462 SMA(m) to SMA(f)	\$24.50
1250-1698 SMA tee(m) (f) (f)	\$50.00
1250-1787 SMA(m) to BNC(m)	\$35.00
1250-2015 SMA(f) to BNC(m)	\$36.00

## Adapters APC-7<sup>®</sup>

11524A APC-7 to N(f)	\$175.00
11525A APC-7 to N(m)	\$170.00
11533A APC-7 to SMA (m)	\$235.00
11534A APC-7 to SMA (f)	\$235.00

## Adapter Banana Plug

1251-2816 Dual banana plug	\$6.00
----------------------------	--------

## Adapters BNC, Standard 50 Ω

1250-0069 BNC(m) to UHF(f)	\$30.00
1250-0071 BNC(f) to UHF(m)	\$15.00
1250-0076 Right angle BNC(UG-306/D)	\$10.75
1250-0080 BNC(f) to BNC(f) (UG-914/U)	\$6.50
1250-0216 BNC(m) to BNC(m)	\$10.50
1250-0591 BNC(f) to WECO Video (m)	\$23.50
1250-0595 BNC(f) to BNC Triaxial (m)	\$20.00
1250-0781 BNC tee(m)(f)(f)	\$12.00
1250-1263 BNC(m) to single banana plug	\$55.00
10110B BNC(m) to dual banana plug	\$27.00
1250-1830 BNC(f) to BNC Triaxial (f)	\$60.00
1251-2277 BNC(f) to dual banana plug	\$15.50

## Adapters BNC, Standard 75 Ω<sup>[3]</sup>

1250-1286 Right angle BNC	\$20.25
1250-1287 BNC(f) to BNC(f)	\$10.25
1250-1288 BNC(m) to BNC(m)	\$13.25

## Adapters SMB, SMC<sup>[4]</sup>

1250-0670 SMC tee(m) (m) (m)	\$30.00
1250-0671 SMB(m) to N(m)	\$57.50
1250-0672 SMB(f) to SMB(f)	\$14.50
1250-0674 SMB(m) to SMA(f)	\$37.00
1250-0675 SMC(m) to SMA(f)	\$33.00
1250-0813 SMB(m) to SMB(m)	\$62.50
1250-0827 SMC(m) to SMC(m)	\$8.25
1250-0831 SMC(m) to BNC(m)	\$26.00
1250-0832 SMC(f) to BNC(f)	\$30.00
1250-0837 SMC tee(m) (m) (m)	\$27.00
1250-0838 SMC tee(f) (m) (m)	\$23.00
1250-1023 SMC(m) to N(m)	\$37.00
1250-1113 SMC(f) to SMC(f)	\$12.50
1250-1152 SMC(f) to N(m)	\$55.00
1250-1153 SMC(f) to N(f)	\$65.00
1250-1236 SMB(f) to BNC(f)	\$32.00
1250-1237 SMB(m) to BNC(f)	\$37.00
1250-1391 SMB tee(f) (m) (m)	\$31.00
1250-1857 SMB(f) to BNC(m)	\$57.50

[1] "Precision": typically ≥36 dB return loss to 1.3 GHz.

[2] Type N outer conductor; center pin sized for 75 Ω characteristic.

[3] BNC outer conductor; center pin sized for 75 Ω characteristic.

[4] SMB & SMC are used often inside HP instruments for inter-module RF connections.

SMB is snap-on configuration. SMC is screw-on configuration.

[5] The K-connector is developed & manufactured by the Wiltron Co, Morgan Hill, CA.

© APC-7 is a registered trademark of the Bunker Ramo Corporation

☎ For same-day shipment, call HP DIRECT at 800-538-8787

## OPERATING CASES

### Rugged Protection for Instruments

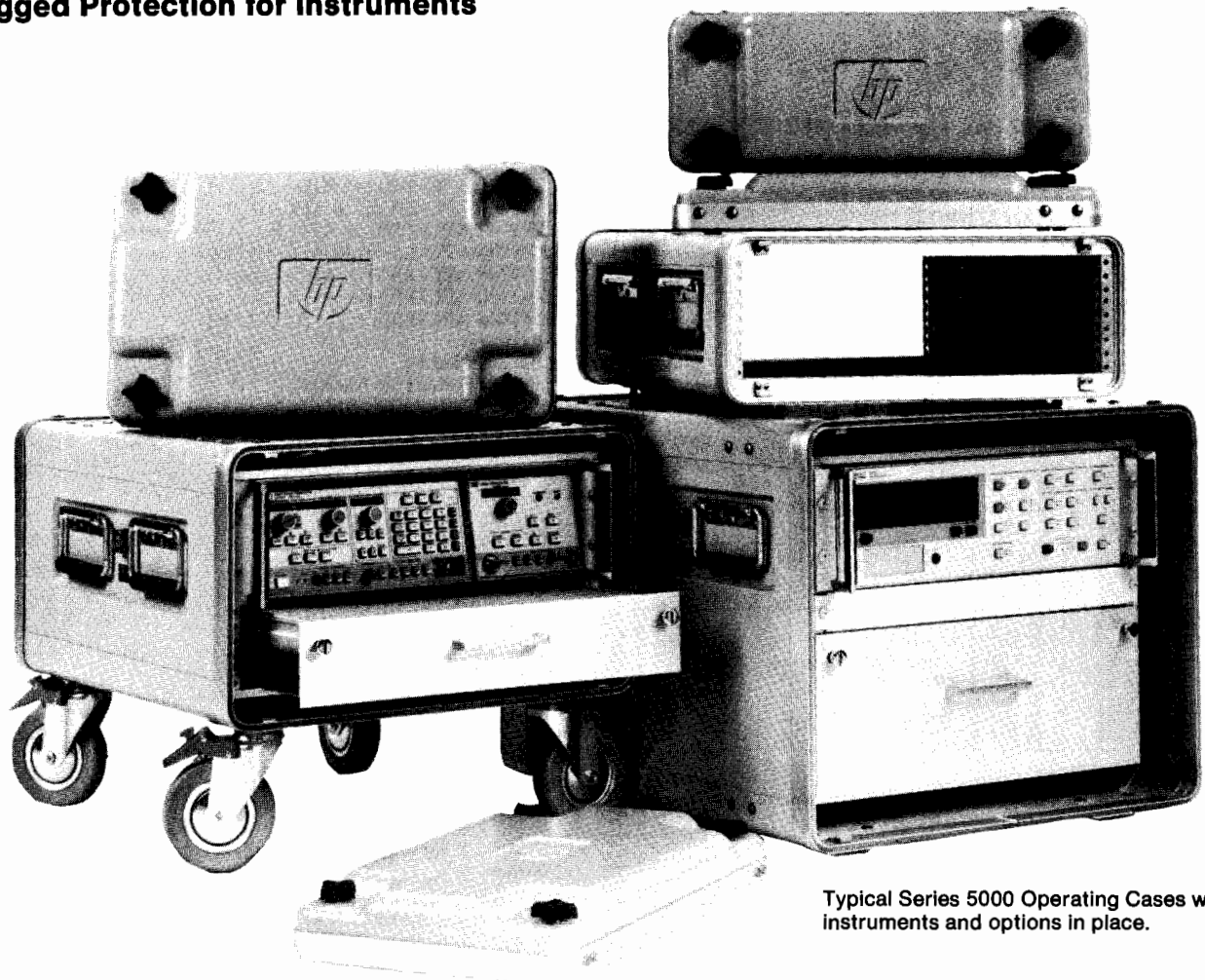

Typical Series 5000 Operating Cases with instruments and options in place.

### Operating Cases

Hewlett-Packard operating cases protect instruments and equipment from the hazards of transportation and the rigors of the environment. They offer sturdy protection when instruments are transported and used on-site. Operating cases are compression molded from a glass fiber reinforced composite material (FRP) that is lighter than aluminum, and provides excellent strength and durability. Tests of this molded material show tensile and compressive strength exceeding 33,000 PSI and flexural strength exceeding 46,000 PSI.

Both standard and optional heavy-duty hardware afford excellent protection from damage and the elements. Conveniently placed, surface mounted, spring-loaded handles fold flat when not in use, or can be designed to reside in recesses. Front and back covers

seal with O-ring gaskets and clamping latches. All cases are rainproof under MIL-STD-108. On request, operating cases can be fabricated to meet the requirements of USA and NATO military specifications.

### Interior Configuration

Operating cases come equipped with shockmounted aluminum frames that accept any standard 19-inch rackmounting instrument (EIA-RETMA standard) up to the height of the frames. Most full-sized instruments and modular combinations of instruments can be rackmounted in any one of our operating cases. The frame arrangement and the ability to remove the front and back covers allows for convenience of operation without removing the instrument. Consequently, the instrument can be set up for operation with a minimum of delay. Both HP System I and System II cabinet styles can be mounted in operating cases (including System I and System II module combining cases).

Rackmounting offers a number of conveniences. Total systems configured of individual instruments and accessories can be combined in one or more operating cases. Patch cable, HP-IB, and HP-IL connections can be left in place within the case, so that instruments are ready for use with little or no delay.

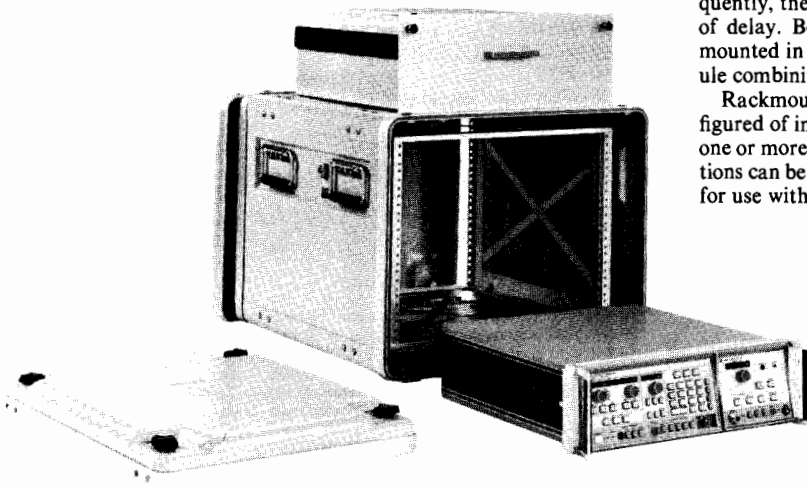

Exploded view of Series 5000 Operating Case with instrument and drawer ready for mounting.

### Operating Case Series 3000

(Standard Case with Surface Mount Hardware)

HP Operating Cases are available in 6 standard families with rack heights from 2 units up.

Nominal Rack Height In.	ISO	Instrument Weight		Case Height		HP Part Number	*Price				
		maximum lbs	minimum kg	In.	mm		1-4	5-9	10-24		
5.25	3U	75	34	20	9.1	11.03	280.2	9211-1302	\$1,850	\$1,600	\$1,400
7.00	4U	75	34	20	9.1	13.73	348.7	9211-6472	\$2,000	\$1,750	\$1,550
8.75	5U	130	59	30	13.6	15.48	393.2	9211-1303	\$2,000	\$1,800	\$1,550
10.50	6U	130	59	30	13.6	17.28	438.9	9211-2635	\$2,050	\$1,800	\$1,600
12.25	7U	130	59	30	13.6	19.15	486.4	9211-1163	\$2,100	\$1,850	\$1,650
14.00	8U	130	59	30	13.6	20.78	527.8	9211-1241	\$2,500	\$2,250	\$2,000
15.75	9U	130	59	30	13.6	22.53	572.3	9211-1242	\$2,500	\$2,250	\$2,000
17.50	10U	130	59	30	13.6	24.28	616.7	9211-1243	\$2,500	\$2,250	\$2,050
19.25	11U	130	59	30	13.6	26.03	661.2	9211-1244	\$2,600	\$2,350	\$2,100
21.00	12U	250	114	50	22.7	28.28	718.3	9211-1245	\$2,350	\$2,050	\$1,850
22.75	13U	250	114	50	22.7	30.03	762.8	9211-2636	\$2,900	\$2,500	\$2,300
24.50	14U	250	114	50	22.7	31.78	807.2	9211-1911	\$2,900	\$2,500	\$2,300
26.25	15U	250	114	50	22.7	33.53	851.7	9211-2637	\$2,900	\$2,700	\$2,300
28.00	16U	250	114	50	22.7	35.28	896.1	9211-2638	\$2,900	\$2,700	\$2,300
29.75	17U	250	114	50	22.7	37.03	940.6	9211-2639	\$2,900	\$2,700	\$2,300
31.50	18U	250	114	50	22.7	38.78	985.0	9211-2640	\$2,900	\$2,700	\$2,300
33.25	19U	250	114	50	22.7	40.53	1029.5	9211-1713	\$2,900	\$2,700	\$2,300
35.00	20U	320	145	70	31.8	42.28	1073.9	9211-6473	\$3,100	\$2,800	\$2,500
36.75	21U	320	145	70	31.8	43.66	1109.0	9211-6474	\$3,200	\$2,900	\$2,600
38.50	22U	320	145	70	31.8	45.78	1162.8	9211-6475	\$3,400	\$3,000	\$2,600
40.25	23U	320	145	70	31.8	47.53	1207.3	9211-6476	\$3,500	\$3,100	\$2,700
42.00	24U	320	145	70	31.8	49.40	1254.8	9211-6477	\$3,500	\$3,200	\$2,800
43.75	25U	320	145	70	31.8	51.03	1296.2	9211-6478	\$3,600	\$3,300	\$2,900
45.50	26U	320	145	70	31.8	52.78	1340.6	9211-6479	\$3,900	\$3,400	\$3,000
47.25	27U	320	145	70	31.8	54.00	1371.6	9211-2641	\$4,000	\$3,500	\$3,000

Standard case width = 24.00 in./609.6 mm. Standard case depth = 28.50 in./723.9 mm. Basic case dimensions exclusive of hardware. Weight range will determine selection of shock mounts. \*Prices shown are subject to change.

### Thermo-stamped Composite (TSC) Operating Cases

In addition to standard pressure-molded glass fiber reinforced composite material (FRP), HP also offers, by special order, operating cases constructed of a thermo-stamped composite (TSC) material. This material offers high performance characteristics similar to FRP, with high impact resistance and light weight. It is available in limited case sizes and is best suited for high-volume production.

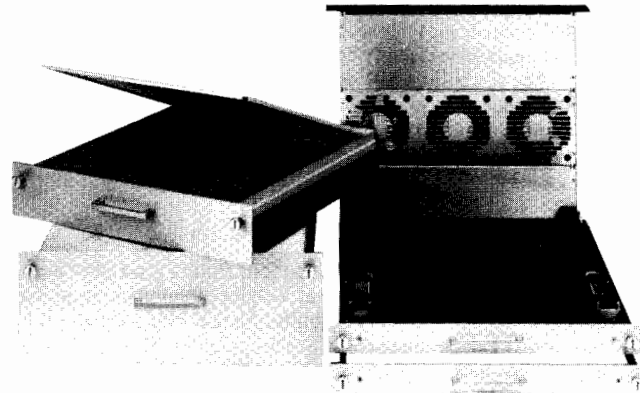

### Special Features Available

- A. 3 1/2 H (88.9 mm) Drawer with ball bearing slides. \$330
- B. 5 1/4 H (133.4 mm) Drawer with ball bearing slides. \$350
- C. 7 H (177.8 mm) Drawer with ball bearing slides. \$370
- D. Slide shelf with ball bearing slides. \$750
- E. Mating feet for stacking one case on top of another. \$50
- F. Mating feet with locking mechanism. \$105
- G. AC power receptacle strip with four outlets mounted on bottom rear of rack frame. Power cord 1 meter (3' 3" long), NEMA connectors. \$50
- H. Pair of L-bar instrument support brackets. \$62.50
- I. Addition of four permanently mounted, 3 1/2" diameter swivel casters. \$120
- J. Addition of four removable, 3 1/2" diameter swivel casters. Available also in kit form. \$250
- K. Special color. Please specify. \$40
- L. 1 U (1.75") modular cooling device with 3 fan upward venting action. 110 V. \$750

### How to Order

Operating Cases are ordered through your local HP sales office. See Customer Ordering Guidelines on page 711.

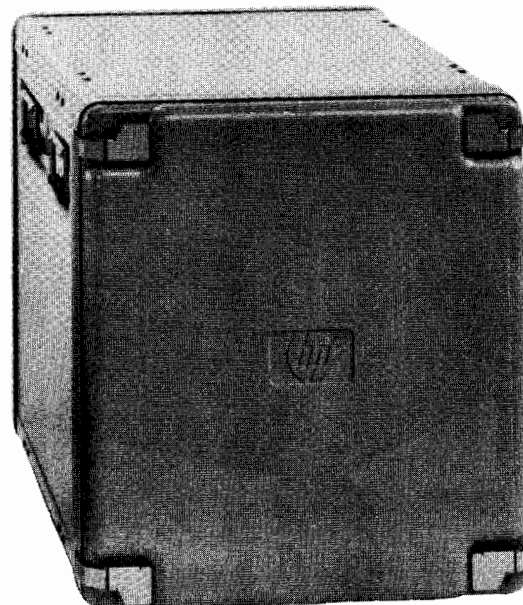

Thermo-stamped Composite (TSC) Operating Case and Glass Fiber Reinforced Composite (FRP) Operating Case with optional surface mount latches.

# TRANSIT CASES

## Rugged Protection for Instruments

### Transit Cases

Hewlett-Packard transit cases are sturdy containers for use when instruments must be frequently transported or used away from laboratory or office conditions. HP cases protect your instruments from shock, vibration, moisture, impact, and contamination to provide a secure enclosure for shipping. Transit cases are a necessity whenever equipment is frequently transported from one operating location to another.

### Product Detail

Our transit cases are compression molded from a glass fiber reinforced (FRP) composite material that is lighter than aluminum and provides excellent strength and durability. Tests of this molded material show tensile and compressive strength exceeding 33,000 PSI and flexural strength exceeding 46,000 PSI. All cases seal tightly with O-ring gaskets and clamping latches. They are rainproof under the standards of MIL-STD-108. Carrying handles are conveniently placed and are spring-loaded to fold flat when not in use.

HP cases are usually provided with foam cushions designed to cradle the instrument securely. The cushion inserts are typically molded polyurethane, or are fabricated from slabs of polyurethane or polyethylene flexible foams. Each case/cushion unit is designed as its own

shock and vibration damping system, protecting against damage from handling, dropping, or crushing.

Our standard transit cases safeguard your equipment from all but the most abusive treatment. To ensure maximum protection for instruments, transit cases are also available to meet the specified requirements of MIL-STD-108, MIL-T-21200, MIL-T-28800, MIL-T-4734 and MIL-C-4150.

Removable swivel casters are available as an option on certain cases. These are identified with an asterisk (\*) in the case tables on pages 712 and 713.

### Instrument Cabinet System Styles

HP produces two styles of cabinet systems: System I and System II. The most visible difference between the two styles is handle configuration. The handles on System I instruments are part of the instrument sideframe, projecting at 90 degrees from the instrument face. The handles on System II modules also project at 90 degrees from the instrument face, but are not part of the instrument frame. These handles can be easily removed and are turned outward at the handle grip. Each cabinet style requires a different cushion insert configuration. This difference makes it important that you order your case from the proper selection table.



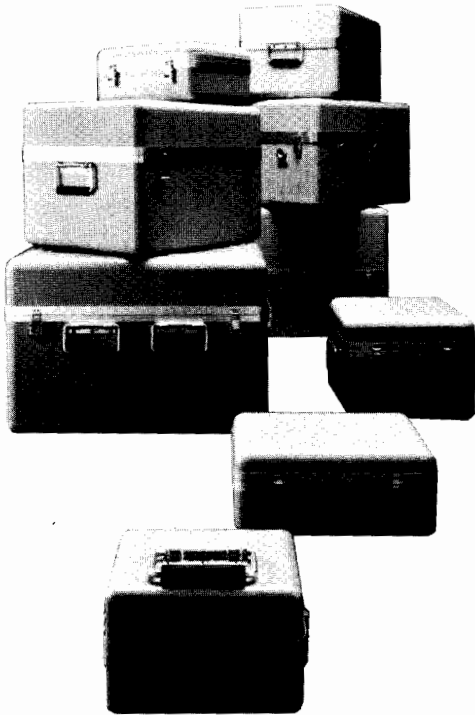

### Transit Case Styles

Each transit case is coded to its style in the following tables: Transit (T), a completely removable cover with a handle at each end; Valise (V), hinged with the handle opposite the hinge; and Valise Transit (VT), a hinged transit case with a handle opposite the hinge and a handle at each end. Each case is designed and manufactured in the style that best suits the configuration of its instrument. If a style other than the standard is required for your application, a custom case can be ordered.



Typical System II Valise Transit (VT) Case.

### Special or Custom Transit Cases

Proper fit is critical in protecting your instrument, and the dimensional measurements play a key role. We recommend when ordering a custom case that you provide your HP sales office with the instrument's exact height, width, depth, the serial and model number, and any other pertinent information that may affect the design of the case or cushions (see Customer Ordering Guidelines). For example, you may wish to have additional space available for the protected storage of materials necessary for your instrument's on-site operation. Space can be provided for power/data cables, operating supplies, accessories, additional printed circuit boards, and documentation or manuals.

## CUSTOMER ORDERING GUIDELINES

Hewlett-Packard offers a **CUSTOMER QUESTIONNAIRE** guide to help you identify specifications to meet your particular enclosure needs. To obtain information on how to order, contact your HP sales representative or call 916-785-8000, SMO Procurement.

EQUIPMENT INFORMATION	ENCLOSURE INFORMATION
<p><b>PART NUMBER:</b> Identification of the equipment or equipment system to be enclosed by part number, drawing number, etc.</p> <p><b>SIZE:</b> To assure proper fit, each instrument must be carefully measured in the following manner:</p> <p><b>WIDTH:</b> The distance across the entire body of the instrument, not including rackmounting accessories. Instruments set up to be rackmounted require special cushion designs.</p> <p><b>DEPTH:</b> The depth of the instrument from the front panel face to the rearmost projection from the back of the instrument. On a System II instrument, add 2 inches if the instrument has handles.</p> <p><b>HEIGHT:</b> The actual instrument height from the base of the cabinet to the top of the cabinet. Measure the height of feet separately.</p> <p><b>WEIGHT:</b> The weight of the equipment to be enclosed.</p> <p><b>FRAGILITY:</b> Specific fragility expressed in G forces, if that is known.</p> <p><b>USAGE REQUIREMENTS:</b> Specific information about how the equipment will be operated, stored, shipped, etc. Special requirements such as unusual heat dissipation, RFI/EMI/ESD shielding, orientation, operating environment.</p>	<p><b>TYPE:</b> Transit or operating case. Style and series.</p> <p><b>SIZE:</b> The maximum size of the case or enclosure.</p> <p><b>USAGE:</b> Operating/transportation/storage requirements. Environmental exposure to moisture, humidity, salt spray, temperature, altitude changes, corrosives, solar radiation, decontaminants, rough handling, etc.</p> <p><b>OPTIONS:</b> Special latches, casters, dust boots, ventilation, drawers, shelves, writing surfaces, hold-down straps, stacking feet, cushions, internal power receptacles, etc.</p> <p><b>MISCELLANEOUS:</b> Military specifications, inspection requirements, labels and markings, color, etc.</p> <p>The case selection tables include American standard and metric measurements. The addition of any options, accessories or standoff devices will affect the instrument's overall configuration and must be taken into consideration when ordering a transit or operating case.</p>

# TRANSIT CASES

## Rugged Protection for Instruments (cont'd)

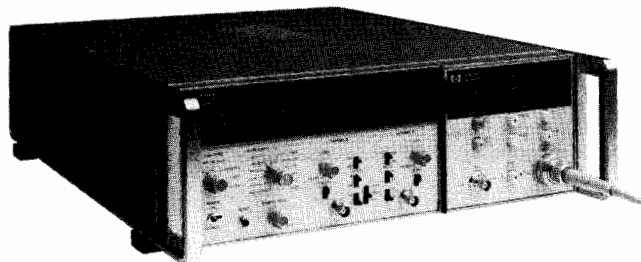

Typical full module System I style cabinet



Typical full module System II style cabinet.

### System I Cabinet Style Transit Cases

Full Module Width Instruments					
Instrument Width - 16.75 in. 425.5 mm					
Instrument Depth - 11.25 in. 285.8 mm					
Inst. Height		Style	HP Part Number	**Price	
in.	mm			1-4	5-49
3.50	88.9	VT*	9211-1288	\$370	330
5.25	133.4	VT*	9211-1289	\$380	340
7.00	177.8	VT*	9211-1290	\$390	360
8.75	222.3	T*	9211-1291	\$420	380
Instrument Depth - 16.25 in. 412.8 mm					
Inst. Height		Style	HP Part Number	**Price	
in.	mm			1-4	5-49
3.50	88.9	VT*	9211-1292	\$400	370
5.25	133.4	VT*	9211-0839	\$420	380
7.00	177.8	VT*	9211-1293	\$430	390
8.75	222.8	VT*	9211-1294	\$430	390
10.50	266.7	T*	9211-1295	\$430	390
12.25	311.2	T*	9211-1313	\$450	410
Instrument Depth - 19.25 in. 489.0 mm					
Inst. Height		Style	HP Part Number	**Price	
in.	mm			1-4	5-49
5.25	133.4	VT*	9211-1296	\$440	400
7.00	177.8	VT*	9211-1735	\$450	410
Instrument Depth - 22.25 in. 565.2 mm					
Inst. Height		Style	HP Part Number	**Price	
in.	mm			1-4	5-49
12.25	311.2	T	9211-1297	\$480	430

\*Removable casters are an option.

Two-thirds Module Width Instruments					
Instrument Width - 10.50 in. 266.7 mm					
Instrument Depth - 11.00 in. 270.4 mm					
Inst. Height		Style	HP Part Number	**Price	
in.	mm			1-4	5-49
6.5	165.1	V	9211-1895	\$330	300
Half Module Width Instruments					
Instrument Width - 7.75 in. 196.9 mm					
Instrument Depth - 8.00 in. 203.2 mm					
Inst. Height		Style	HP Part Number	**Price	
in.	mm			1-4	5-49
6.5	165.1	V	9211-1316	\$300	270
Instrument Depth - 11.00 in. 279.4 mm					
Inst. Height		Style	HP Part Number	**Price	
in.	mm			1-4	5-49
6.5	165.1	V	9211-1315	\$310	280
Instrument Depth - 16.00 in. 406.4 mm					
Inst. Height		Style	HP Part Number	**Price	
in.	mm			1-4	5-49
6.5	165.1	V	9211-1734	\$330	300

\*Removable casters are an option.

\*\*Prices shown are subject to change.

One-third Module Width Instruments					
Instrument Width - 5.125 in. 130.2 mm					
Instrument Depth - 8.00 in. 203.2 mm					
Inst. Height		Style	HP Part Number	**Price	
in.	mm			1-4	5-49
6.5	165.1	V	9211-1317	\$290	260
Instrument Depth - 11.00 in. 279.4 mm					
Inst. Height		Style	HP Part Number	**Price	
in.	mm			1-4	5-49
6.5	165.1	V	9211-1318	\$300	270

### System II Cabinet Style Transit Cases

Full Module Width Instruments					
Instrument Width - 16.75 in. 425.5 mm					
Instrument Depth - 15.25 in. 387.4 mm					
Inst. Height		Style	HP Part Number	**Price	
in.	mm			1-4	5-49
3.50	88.9	VT	9211-2642	\$430	390
5.25	133.4	VT	9211-2643	\$430	390
7.00	177.8	VT	9211-2644	\$430	390
8.75	222.3	VT	9211-2645	\$430	390
10.50	266.7	T*	9211-2646	\$430	390
12.25	311.2	T*	9211-2647	\$430	390
Instrument Depth - 18.25 in. 463.6 mm					
Inst. Height		Style	HP Part Number	**Price	
in.	mm			1-4	5-49
3.50	88.9	VT	9211-2648	\$480	430
5.25	133.4	VT	9211-2649	\$480	430
7.00	177.8	VT	9211-2650	\$480	430
8.75	222.3	T*	9211-2651	\$480	430
10.50	266.7	T*	9211-2652	\$480	430
12.25	311.2	T*	9211-2653	\$480	430
Instrument Depth - 21.50 in. 546.1 mm					
Inst. Height		Style	HP Part Number	**Price	
in.	mm			1-4	5-49
3.50	88.9	VT	9211-2654	\$520	470
5.25	133.4	VT	9211-2655	\$520	470
7.00	177.8	VT	9211-2656	\$520	470
8.75	222.3	T*	9211-2657	\$520	470
10.50	266.7	T*	9211-2658	\$520	470
12.25	311.2	T*	9211-2659	\$520	470
Instrument Depth - 24.50 in. 622.3 mm					
Inst. Height		Style	HP Part Number	**Price	
in.	mm			1-4	5-49
3.50	88.9	VT	9211-2660	\$550	500
5.25	133.4	VT	9211-2661	\$550	500
7.00	177.8	T*	9211-2662	\$550	500
8.75	222.3	T*	9211-2663	\$550	500
10.50	266.7	T*	9211-2664	\$550	500
12.25	311.2	T*	9211-2665	\$550	500



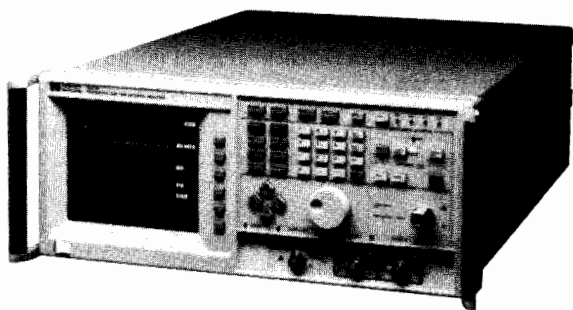

Typical System II half module instrument

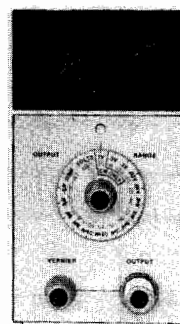

Typical System II quarter module instrument

**System II Cabinet Style Transit Cases (Continued)**

Half Module Width Instruments					
Instrument Width – 8.50 in. 215.9 mm					
Instrument Depth – 9.75 in. 247.7 mm					
Inst. Height		Style	HP Part Number	**Price	
in.	mm			1-4	5-49
3.50	88.9	V	9211-2666	\$330	300
5.25	133.4	V	9211-2667	\$330	300
7.00	177.8	V	9211-2668	\$330	300
8.75	222.3	V	9211-2669	\$330	300
10.50	266.7	V*	9211-2670	\$330	300
Instrument Depth – 12.75 in. 323.9 mm					
Inst. Height		Style	HP Part Number	**Price	
in.	mm			1-4	5-49
3.50	88.9	V	9211-2671	\$390	350
5.25	133.4	V	9211-2672	\$390	350
7.00	177.8	V	9211-2673	\$390	350
8.75	222.3	V	9211-2674	\$390	350
10.50	266.7	V	9211-2675	\$390	350
Instrument Depth – 15.75 in. 400.1 mm					
Inst. Height		Style	HP Part Number	**Price	
in.	mm			1-4	5-49
3.50	88.9	V	9211-2676	\$400	360
5.25	133.4	V	9211-2677	\$400	360
7.00	177.8	V	9211-2678	\$400	360
8.75	222.3	V	9211-2679	\$400	360
10.50	266.7	V	9211-2680	\$400	360
Instrument Depth – 18.75 in. 476.3 mm					
Inst. Height		Style	HP Part Number	**Price	
in.	mm			1-4	5-49
3.50	88.9	V	9211-2681	\$400	360
5.25	133.4	V	9211-2682	\$400	360
7.00	177.8	V	9211-2683	\$400	360
8.75	222.3	V	9211-2684	\$400	360
10.50	266.7	V	9211-2685	\$400	360

\* Removable casters are an option.  
 \*\* Prices shown are subject to change.

Quarter Module Width Instruments					
Instrument Width – 4.125 in. 104.8 mm					
Instrument Depth – 9.75 in. 247.7 mm					
Inst. Height		Style	HP Part Number	**Price	
in.	mm			1-4	5-49
3.50	88.9	V	9211-2686	\$280	250
5.25	133.4	V	9211-2687	\$280	250
7.00	177.8	V	9211-2688	\$280	250
Instrument Depth – 12.75 in. 323.9 mm					
Inst. Height		Style	HP Part Number	**Price	
in.	mm			1-4	5-49
3.50	88.9	V	9211-2689	\$290	260
5.25	133.4	V	9211-2690	\$290	260
7.00	177.8	V	9211-2691	\$290	260
Instrument Depth – 15.75 in. 400.1 mm					
Inst. Height		Style	HP Part Number	**Price	
in.	mm			1-4	5-49
3.50	88.9	V	9211-2692	\$350	310
5.25	133.4	V	9211-2693	\$350	310
7.00	177.8	V	9211-2694	\$350	310

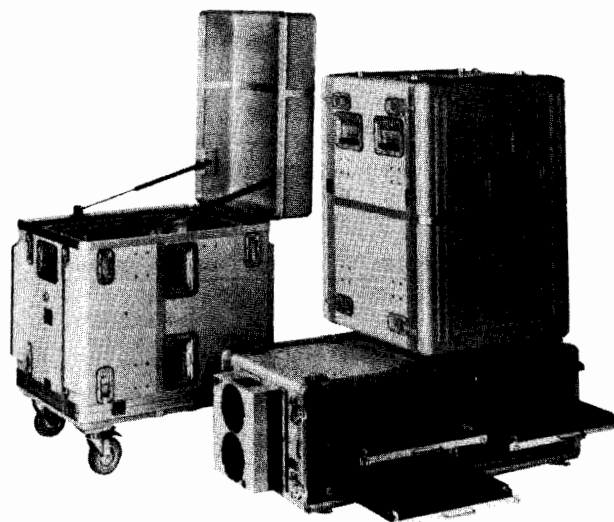

Variety of custom Operating Cases with options.

# CABINETS & CABINET ACCESSORIES

## System II Plus—Handles and Rack Flanges, Bail Handle Kit

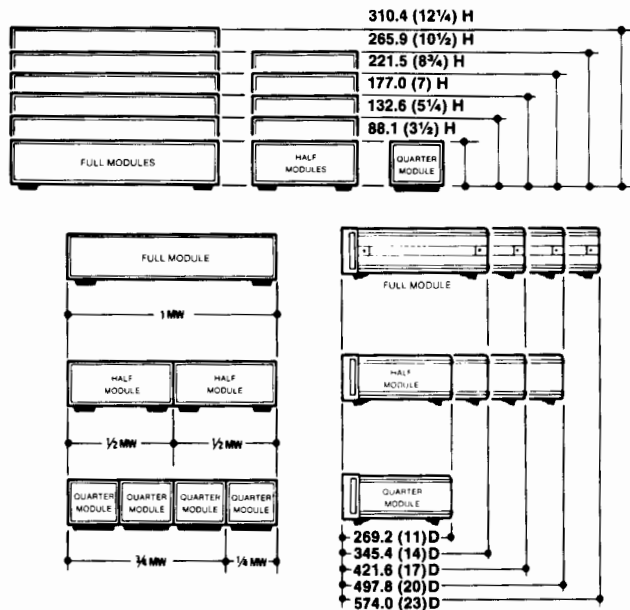

System II Cabinet Design

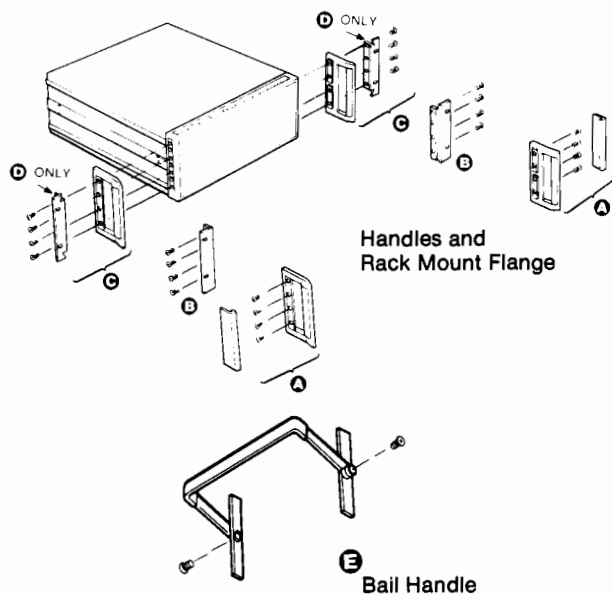

NOTICE—Most of the cabinet accessory kits shown on these pages include both inch and metric fasteners to make them compatible with the new metric-fastener-cabinets, as well as the older inch-fastener-cabinets which are still in service. It is most important for the user to be aware of these different fasteners to avoid thread damage when attaching the accessory kits. Metric-fastener-cabinets are identified with a yellow label on the rear which reads “Caution—metric and inch hardware”, a “metric” embossment in the front bezel casting under the plastic trim strip, and on the middle of the rear bezel casting.

### System II and System II Plus Cabinet Design

HP’s modular cabinet system offers bench-stacking and rack mounting versatility. These cabinets are designed for compatibility with EIA and IEC standards, both in width and height.

System II Plus cabinets and accessories are identical in form, fit, and function as System II, but are different colors for improved visual continuity. This catalog lists System II Plus part numbers only.

### Handles and Rack Mount Flanges

Handles and rack flanges are available for all System II cabinets, although they find most use on full width modules or combinations of narrower modules locked together to form 1 MW (module width).

Certain instruments are supplied with front handles as part of the selling price. Handles and rack flanges can be supplied with most instruments by specifying the appropriate option from the following list, at the time of order. The extra cost of each option is usually specified on the instrument data sheet.

- Option 907 Front Handles
- Option 908 Rack Mount Flanges
- Option 909 Handles with Rack Flanges
- Option 913 Rack Mount Flanges (If handles already furnished) (HP 5062-4069 Version)

The table below describes kits available for use after receipt of equipment. Field installation is very straight-forward. A plastic trim strip is easily removed and the handle or flange attached with screws supplied in the kit. Before rack mounting, bottom feet must be removed.

### Bail Handle Kit

For 1/2 MW cabinets, you can attach this front bail handle for easy portability. Attaching hardware furnished.

HP Part No.	Name	Price
HP 5062-4001	Bail Handle Kit for 88.1 (3 1/2) Module	\$38
HP 5062-4002	Bail Handle Kit for 132.6 (5 1/4) Module	35
HP 5062-4003	Bail Handle Kit for 177.0 (7) Module	33

### Handle and Rack Flanges

Instrument Module Height mm (in)	A Front Handle Kit		B Rack Mount Flange Kit [3]		C Rack Mount Flange Kits with Handles		D Rack Mount Flange Kit for Instruments With Previously Supplied Handles	
	HP Part No	Price	HP Part No	Price	HP Part No	Price	HP Part No	Price
88.1 (3 1/2)	HP 5062-3988	\$ 50.00	HP 5062-3974[1]	\$31.00	HP 5062-3975[1]	\$ 72.50	HP 5062-4069[1]	\$21.00[4]
88.1 (3 1/2)	—	—	HP 5062-3976[2]	31.00	HP 5062-3982[2]	72.50	HP 5062-4070[2]	36.00[4]
132.6 (5 1/4)	HP 5062-3989	55.00	HP 5062-3977	33.50	HP 5062-3983	82.50	HP 5062-4071	28.00
177.0 (7)	HP 5062-3990	65.00	HP 5062-3978	36.00	HP 5062-3984	95.00	HP 5062-4072	32.00
221.5 (8 3/4)	HP 5062-3991	75.00	HP 5062-3979	40.00	HP 5062-3985	105.00	HP 5062-4073	36.00
265.9 (10 1/2)	HP 5062-3992	95.00	HP 5062-3980	45.00	HP 5062-3986	120.00	HP 5062-4074	40.00
310.4 (12 1/4)	HP 5062-3993	140.00	HP 5062-3981	50.00	HP 5062-3987	160.00	HP 5062-4075	49.00
<b>Kit includes</b>	2 Handles + 2 Trim Strips + Mtg. Screws		2 Flanges + Mtg. Screws		2 Handles + 2 Flanges + Mtg. Screws		2 Flanges + Mtg. Screws	

[1] HP 5062-3974/3975/4069 Kits use standard flanges with 1.75" hole spacing.  
 [2] HP 5062-3976/3982/4070 Kits use special flange with 3.00" hole spacing.

[3] Will not fit onto instruments with previously supplied handles.  
 [4] Option 913 ordered on instruments supplies HP 5062-4069. For 3.00" spacing order HP 5062-4070 instead of Opt. 913.

**NOTICE**—Most of the cabinet accessory kits shown on these pages include both inch and metric fasteners to make them compatible with the new metric-fastener-cabinets, as well as the older inch-fastener-cabinets which are still in service. It is most important for the user to be aware of these different fasteners to avoid thread damage when attaching the accessory kits. Metric-fastener-cabinets are identified with a yellow label on the rear which reads “Caution—metric and inch hardware”, a “metric” embossment in the front bezel casting under the plastic trim strip, and on the middle of the rear bezel casting.

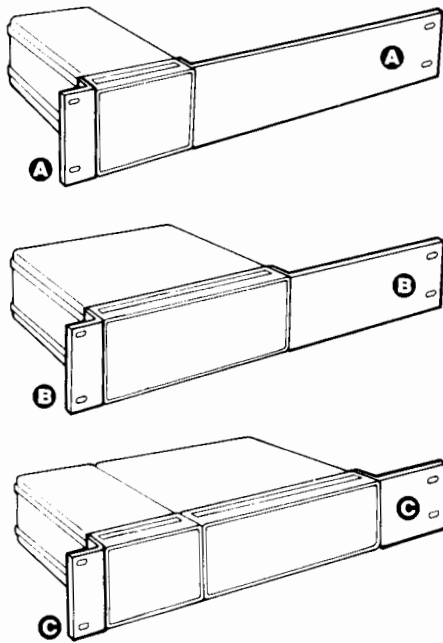

### Rack Mount Adapter Kits

Modules of less than 1 MW can be rack mounted using these kits. Individual 1/4 MW or 1/2 MW modules use the kits shown below directly. Combinations of 1/4 MW and 1/2 MW (of equal depth) are first joined side-by-side with the Lock Link Kit (HP 5062-3994) (following page), then have end flanges applied. Combinations adding to 1 MW use regular rack flange kit (previous page). Kits include attaching screws but not front panel rack mounting screws. Hole patterns conform to EIA and IEC standards.

### Rack Mount Adapter Kits

Module Height mm (in)	A Mounts 1/4 MW Module		B Mounts 1/2 MW or 2 ea. 1/4 MW[2] Modules		C Mounts 3/4 MW (3 ea. 1/4 MW)[1] or 1/4 & 1/2 MW side-by-side[2]	
	HP Part No	Price	HP Part No	Price	HP Part No	Price
88.1 (3 1/2)	5062-3973	\$56.00	5062-3972	\$51.00	5062-3971	\$43.00
132.6 (5 1/4)	—	—	5062-3957	62.00	5062-3958	50.00
177.0 (7)	—	—	5062-3960	67.00	5062-3961	70.00
265.9 (10 1/2)	—	—	5062-3966	77.50	5062-3967	72.50
<b>Kit includes</b>	1 ea. rack flange 1 ea. 3/4 MW extension adapter flange and screws		1 ea. rack flange 1 ea. 1/2 MW extension adapter flange and screws		1 ea. rack flange 1 ea. 1/4 MW extension adapter flange and screws	

[1] 1/4 MW can be center mounted using 2 of these kits.

[2] Side-by-side modules of equal depth require lock link kit (HP 5062-3994).

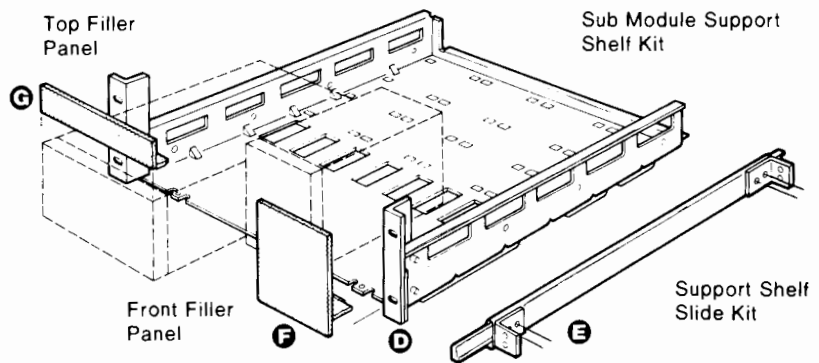

### Support Shelf, Slide, and Filler Panels

Submodules of differing heights, widths, and depths (up to 20 D) may be rack-mounted using these support shelves. Any combination of 1/4 MW and 1/2 MW will fit side-by-side up to 1 MW. Filler panels close up vacant spaces either on top of short modules or side-by-side. The slide kit provides ready access to internal shelf areas and is designed for HP racks with 24-inch depth vertical support rails. Slide kit includes brackets and mounting screws.

HP Part No.	Name	Price
5062-3996	D Support Shelf for 88.1 (3 1/2)H Modules	\$195
5062-3997	D Support Shelf for 132.6 (5 1/4)H Modules	195
5062-3998	D Support Shelf for 177.0 (7)H Modules	210
1494-0015	E Slide Kit (2 ea slides, brackets, hardware)	120

### Filler Panels

Description	Size	HP Part No	Price
F For 88.1 (3 1/2) H support shelf partially filled with instruments, and having the following front panel space to fill:	1/4 MW to fill	5062-4021	\$67.50
	1/2 MW to fill	5062-4022	80.00
	3/4 MW to fill	5062-4023	92.50
F For 132.6 (5 1/4) H support shelf, and having the following front panel space to fill:	1/4 MW to fill	5062-4024	\$80.00
	1/2 MW to fill	5062-4025	87.50
F For 177.0 (7) H support shelf, and having the following front panel space to fill:	1/4 MW to fill	5062-4066	\$75.00
	1/2 MW to fill	5062-4027	110.00
G For 1/4 MW and having the following vertical space to fill:	43.2 (1 3/4)H	5062-2035	\$50.00
	87.6 (3 1/2)H	5062-2036	50.00
G For 1/2 MW and having the following vertical space to fill:	43.2 (1 3/4) H	5062-2037	\$50.00
	87.6 (3 1/2) H	5062-2038	50.00

☎ For same-day shipment, call HP DIRECT at 800-538-8787

# CABINETS & CABINET ACCESSORIES

## System II Plus—Lock Link Kits, Rack Mount Slide Kits

**NOTICE**—Some of the cabinet accessory kits shown on these pages include both inch and metric fasteners to make them compatible with the new metric-fastener-cabinets, as well as the older inch-fastener-cabinets which are still in service. It is most important for the user to be aware of these different fasteners to avoid thread damage when attaching the accessory kits. Metric-fastener-cabinets are identified with a yellow label on the rear which reads "Caution—metric and inch hardware", a "metric" embossment in the front bezel casting under the plastic trim strip, and on the middle of the rear bezel casting. Due to design considerations, the slide-mount kits shown on this page are offered in both inch and metric fastener versions.

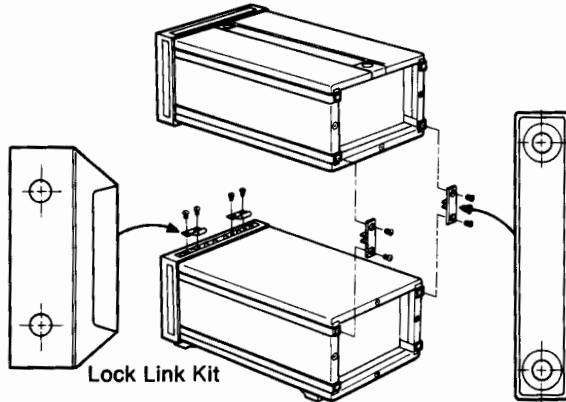

Lock Link Kit

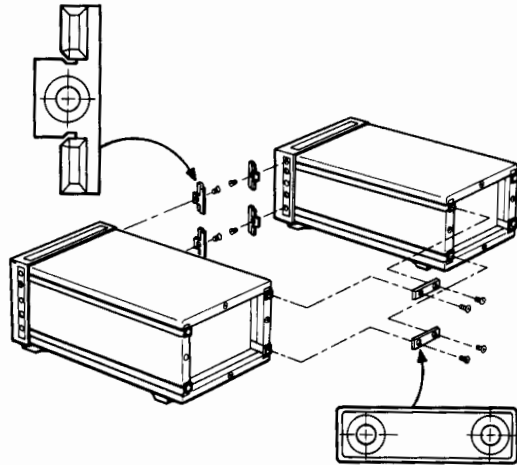

### Lock Link Kits HP 5062-3994 (includes inch screws)

All sub-module cabinets of *equal depths* can be linked together over-under or side-by-side with hardware in the lock link kit. Cabinet frames are already pre-threaded to allow quick assembly. For side-by-side connections the kit contains 12 front hooks and six rear links, enough for 3 side-by-side joints. For vertical connections, the kit also contains four front hooks and four rear links enough for two over-under joints. Kit includes screws. Locking cabinets together horizontally in a configuration wider than 1 MW is not recommended.

If the over-under linked combination is to include rear standoff feet (HP 5062-4009), then the over-under locking feet kit HP 5062-3999 (next page) should be used for over-under connection.

The HP 5062-3994 Lock Link Kit is not recommended for full module over/under combinations. Use Kit HP 5061-9699 Locking Feet Kit (next page) to handle those larger weights.

### Slide Kits and Rack Brackets

Rack slides are available for full-width System II cabinets to permit easy access to internal spaces. Each kit consists of two slides which mount directly to System II cabinet side handle recess spaces (after removing side handles). The slides also mount directly to vertical support rails in HP-racks. HP 1494-0060 mounts 345.4D and 421.6D depth System II cabinets. HP 1494-0059; 497.8D and 574.0D.

Standard weight slides carry 38.6 kg (85 lb) max. load. Tilting versions are available in standard duty only. (HP 1494-0062 and 1494-0063.)

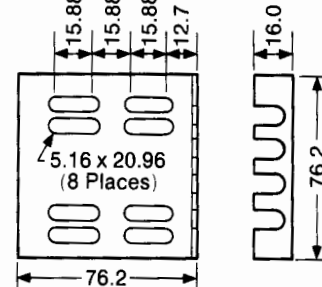
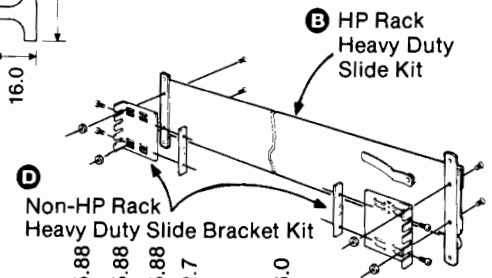
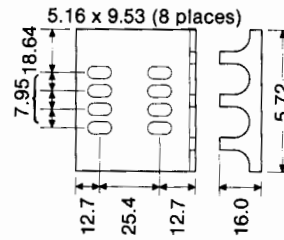
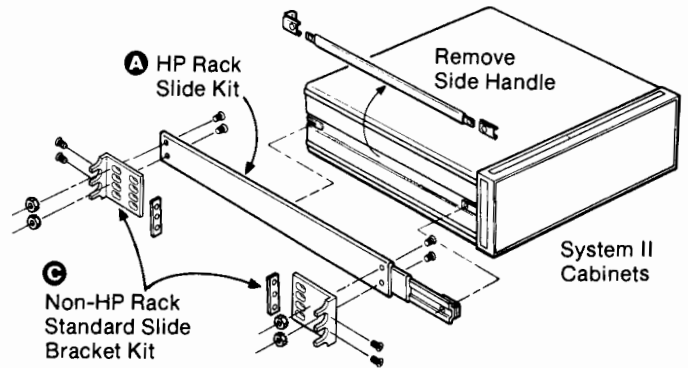

For non-HP racks, end bracket kits are available for both standard and heavy duty slide kits. Slotted hole arrays in the brackets provide for front-to-back rack rail spacing of 24, 26, and 28-inch nominal centers. They also allow choice of two vertical positions. Each kit of four brackets includes screws and four bar nuts. These general purpose mounting brackets fit most common non-HP racks such as GE, Honeywell, etc.

HP Part No	Name	Price
<b>Metric (Inch)</b> <b>5062-3994</b>	Lock Link Kit	\$ 25 ☎
<b>1494-0060</b> <b>(1494-0018)</b>	<b>A</b> Non-Tilting, Std. Slide Kit, Fits 345.4D & 421.6D Cabinets	100 ☎
<b>1494-0059</b> <b>(1494-0017)</b>	<b>A</b> Non-Tilting, Std. Slide Kit, Fits 497.8D & 574.0D Cabinets	100 ☎
<b>1494-0062</b> <b>(1494-0025)</b>	Tilting, Std. Slide Kit, Fits 345.4D & 421.6D Cabinets	190 ☎
<b>1494-0063</b> <b>(1494-0026)</b>	Tilting, Std. Slide Kit, Fits 497.8D & 574.0D Cabinets	190 ☎
<b>1494-0058</b> <b>(1494-0016)</b>	<b>B</b> Non-Tilting, Heavy Duty Slide Kits (497.8D & 574.0D Cabinets Only)	290 ☎
<b>1494-0061</b> <b>(1494-0023)</b>	<b>C</b> (4) End Brackets for Non-HP Racks, Std. Slides	46 ☎
<b>1494-0064</b> <b>(1494-0042)</b>	<b>D</b> (4) End Brackets for Non-HP Racks, Heavy Duty Slides	70 ☎

☎ For same-day shipment, call HP DIRECT at 800-538-8787

**NOTICE**—Most of the cabinet accessory kits shown on these pages include both inch and metric fasteners to make them compatible with the new metric-fastener-cabinets, as well as the older inch-fastener-cabinets which are still in service. It is most important for the user to be aware of these different fasteners to avoid thread damage when attaching the accessory kits. Metric-fastener-cabinets are identified with a yellow label on the rear which reads "Caution—metric and inch hardware", a "metric" embossment in the front bezel casting under the plastic trim strip, and on the middle of the rear bezel casting.

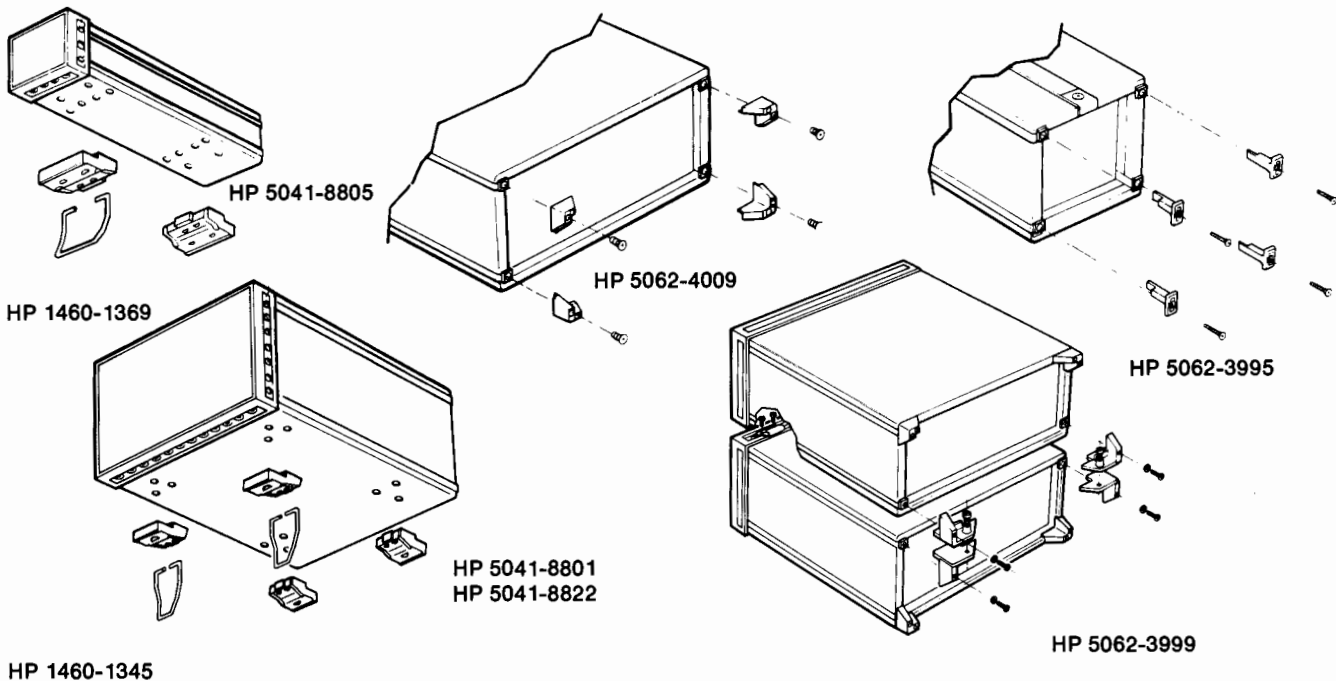

### Bottom and Rear Cabinet Feet

#### Cabinet Rear Standoff Feet HP 5062-4009 (includes inch screws)

Kit HP 5062-4009 provides four corner feet which give 25.4 mm (1-in) stand-off protection to the rear panel of instruments. It is used when instruments are to be operated or stored vertically on their rear panels. (Fits all but 1/4 MW by (88.1) 3½H). Includes mounting screws.

#### Cord Wrap Feet Kit HP 5062-3995 (includes inch screws)

Kit HP 5062-3995 contains four ribbed corner posts on which you can wrap power cords or signal cables for transport or storage. (Recommended for 1/4 MW and 1/2 MW cabinets weighing less than 11 kg, (24 lb). Includes mounting screws.

#### Cabinet Bottom Feet and Tilt Stands

The standard foot HP 5041-8801 fits the bottom of full width and 1/2 MW cabinets. It fits front or rear and four are required. HP 5041-8822 foot is a non-skid version. Used in pairs it can prevent bench-top creeping. Tilt-stand HP 1460-1345 fits into the standard or non-skid foot and is used in pairs (front or rear) to tilt the instrument up or down for better viewing.

For 1/4 MW cabinets, foot HP 5041-8805 fits front or rear (two required). Tilt stand HP 1460-1369 fits the standard 1/4 MW foot and can be used front or rear depending on whether you want an upward or downward display.

#### Rear Panel Locking Foot Kit

When full module cabinets are to be linked vertically, and rear standoff feet are planned, use this kit. It consists of right and left foot linking pairs and 2 front hooks, enough for one over-under joint.

Also requires one HP 5062-4009 foot kit to supply the remaining 4 corner feet.

HP Part No	Name	Price
5062-4009	Rear Standoff Feet Kit (4 Feet)	\$8.75
5062-3995	Cord Wrap Feet Kit (4 Feet)	\$25.00
5041-8801	Standard Foot	\$1.30
5041-8822	Non-Skid Foot	\$3.80
1460-1345	Tilt Stand	\$4.00
5041-8805	1/4 MW Foot	\$7.00
1460-1369	1/4 MW Tilt Stand	\$10.00
5062-3999	1 MW Cabinet Lock-Foot Kit	\$60.00

☎ For same-day shipment, call HP DIRECT at 800-538-8787

# CABINETS & CABINET ACCESSORIES

## SYSTEM 1—Rack Hardware and Accessories

### System 1 Cabinet Design

System 1 Cabinets are still used on older HP instruments. System 1 can be identified by its front handles being integral with the side casting frame. These two pages describe accessories for use with System 1 Cabinets and small modular instruments.

HP 1051A

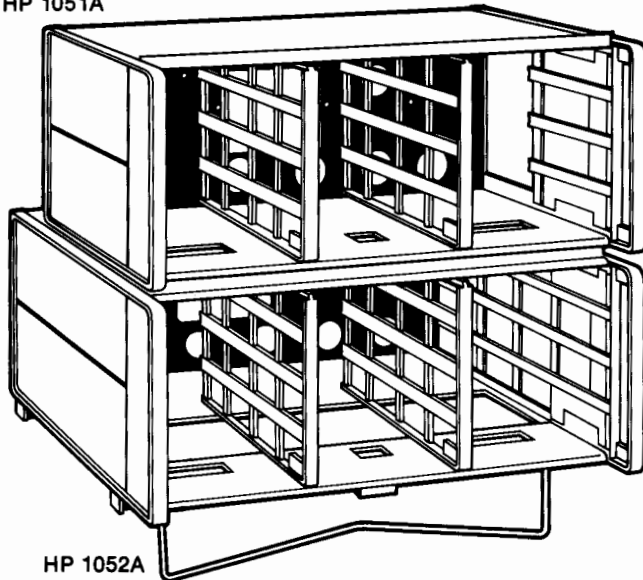

HP 1052A

### Combining Cases, HP 1051A, 1052A

HP 1051A and HP 1052A combining cases conveniently rack or bench mount combinations of small modular Hewlett-Packard SYSTEM 1 instruments. Both cases accept 1/3 or 1/2 instrument modules, 130mm or 198 mm wide (5 1/8 or 7 25/32 in.). The basic difference is that the HP 1052A is 130 mm (5 1/8 in) deeper and will accept modules up to 416mm deep (16 3/8 in). The HP 1051A accepts instruments up to 286mm deep (11 1/4 in). Each case is furnished with two dividers.

Accessory drawer HP 5060-8756 supplies storage space 1/2 width and 77 mm (3-1/32") high. Use an HP 5060-8758 filler panel above or below.

#### HP 1051A, 1052A, 5060-8756 Specifications

Size	Price
HP 1051A: 178 H x 482.6 W x 337 mm D (7" x 19" x 13 1/4").	\$1,050
HP 1052A: 178 H x 482.6 W x 467 mm D (7" x 19" x 18 3/8").	\$1,050

#### Weight

HP 1051A: net, 4.5 kg (10 lb). Shipping, 6.7 kg (15 lb).  
 HP 1052A: net, 5.4 kg (12 lb). Shipping, 8.1 kg (18 lb).

Opt 908: Rack Mount Kit \$40  
 Opt 910: Extra Manual \$1

### Rack Mounting Kits, HP 5060-8739 to 5060-8744

With these kits all Hewlett-Packard products in full rack-width cabinets of the integral side frame-handle style (see HP 1051A, 1052A, Combining Cases above) can be easily prepared for rack mounting. Each kit contains two flanges, a filler strip, and mounting screws.

#### Rack Mounting Kit Ordering Information

HP Part Number	Nominal Cabinet Height		Price
	Millimetres	Inches	
HP 5060-8739	88.1	3 1/2	\$40
HP 5060-8740	132.6	5 1/4	\$40
HP 5060-8741*	177	7	\$40
HP 5060-8742	221.5	8 3/4	\$45
HP 5060-8743	265.9	10 1/2	\$45
HP 5060-8744	310.4	12 1/4	\$50

\*Also used to rack mount Combining Kits HP 1051A & 1052A shown above.

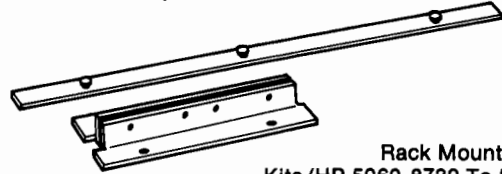

Rack Mounting Kits (HP 5060-8739 To 5060-8744)

HP 5040-6678

HP 5060-8764

HP 5060-8762

HP 5040-6680

### Rack Adapter Frames, HP 5060-8762, 5060-8764

These frames can be used to hold combinations of 1/3 and 1/2 module-width HP instruments. Each frame is furnished with mounting hardware and three dividers. Two models are available for different instrument heights. Adapter frames are for permanent or semi-permanent rack mounting. Where quick removal and reinstallation of instruments is desirable, the HP 1051A and HP 1052A should be used.

HP 5060-8762 is 178 mm (7 in.) high and accepts instruments heights of 1/4H, 1/2H, and 1H. HP 5060-8764 is 89 mm (3 1/2 in.) high and accepts instruments of 1/4H and 1/2H.

HP Part No	Name	Price
HP 5060-8762	Rack Adapter 178mm (7")	\$150
HP 5060-8764	Rack Adapter 89mm (3 1/2")	\$150
HP 5040-6678	Extra Vertical Dividers for 5060-8764	\$28
HP 5040-6680	Extra Vertical Dividers for 5060-8762	\$12

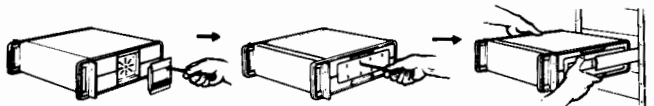

Remove Handles and Feet

Attach Adapter

Mount Slides

### Rack Mount Slide Kits and Cabinet Adapters

By removing the side handle of full width system 1 cabinets, rack mount slides can be attached for easy access to internal space. Both tilting and non-tilt are available, while max. load factor is 31.7 kg (70 lb). The cabinet adapter plate attaches to the handle recess then to the slide. Slide kits include four angle brackets which mount to rack rails with front-to-back nominal spacings of 24, 26 and 28-inches.

#### Cabinet Adapters

HP Part No	Name	Price
HP 1490-0722	Adapter plate for 88.9mm H (3 1/2") cabinets	\$135
HP 1490-0721	Adapter plate for 133mm H (5 1/4") and higher cabinets	\$260

☎ For same-day shipment, call HP DIRECT at 800-538-8787

# CABINETS & CABINET ACCESSORIES

## System 1 - Slide Kits, Fans, Joining Brackets, Cases

719

### Rack Mount Slide Kits, HP 1490-0713 to 1490-0720

HP Part Number <sup>1</sup>	Slide Type	Cabinet Depth	Extension Length	Price
1490-0713	fixed	All Sizes	482.6 (19) <sup>2</sup>	\$140 
1490-0714	fixed	All Sizes	635.0 (25) <sup>3</sup>	\$160 

1. Cabinet Adapters, below, must be added to slides
2. Slide's stationary mounting depth: 406.4 (16)
3. Slide's stationary mounting depth: 558.8 (22)

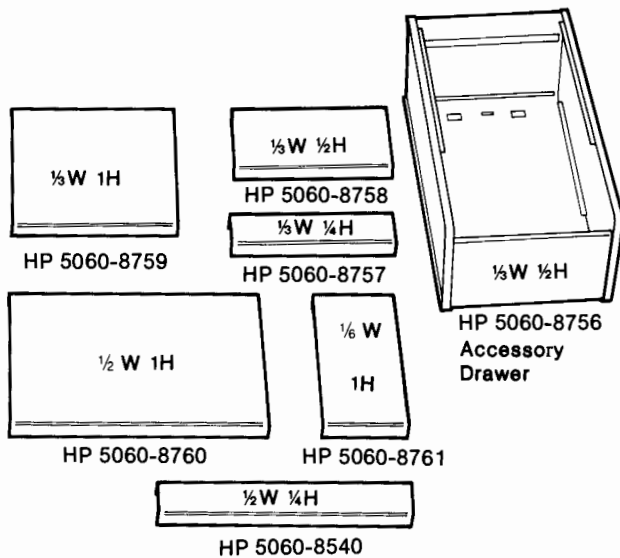

### Filler Panels, HP 5060-8540, 5060-8757 to 5060-8761

Filler panels can be used to close off any leftover space after instruments are mounted in combining cases (left) or adapter frames (below). Panels are available in a variety of widths and heights.

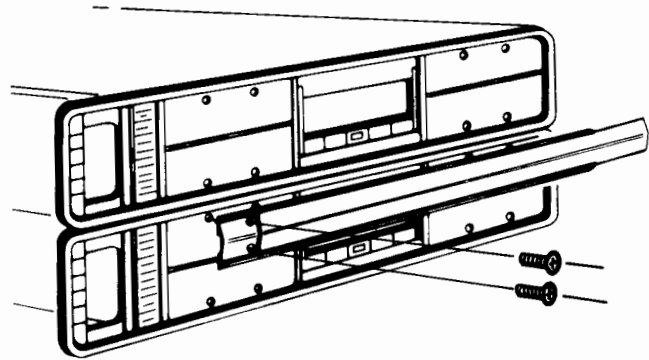

HP Part No	Module Case Height x Width	Filler Panel Dimensions		Price
		Millimeters	Inches	
5060-8540	1/4 x 1/2	38 x 198	1 1/2 x 7 <sup>25</sup> / <sub>32</sub>	\$54
5060-8757	1/4 x 1/3	38 x 130	1 1/2 x 5 1/8	\$75
5060-8758	1/2 x 1/3	77 x 130	3 1/32 x 5 1/8	\$43
5060-8759	full x 1/3	155 x 130	6 3/32 x 5 1/8	\$43
5060-8760	full x 1/2	155 x 198	6 3/32 x 7 <sup>25</sup> / <sub>32</sub>	\$44
5060-8761	full x 1/6	155 x 63	6 3/32 x 2 <sup>31</sup> / <sub>64</sub>	\$70

 For same-day shipment, call HP DIRECT at 800-538-8787











### Joining Bracket Kits, HP 5060-8541 to 5060-8545

These kits join HP System 1 instruments of the same width and length into easily handled single stacks. Each kit consists of two brackets, mounting hardware and trim. They are available to fit the three most common instrument depths:

HP Part Number	Price
5060-8541: 279 mm (11 in.) EIA panel depth	\$160 
5060-8543: 406 mm (16 in.) EIA panel depth	\$160 
5060-8545: 480 mm (19 in.) EIA panel depth	\$170 

### Vectra

You can now rack mount the Vectra SPU, VGA monitor and keyboard. A rail kit for both SPU and the monitor are required to complete the installation. For HP racks, the 12679B rail kit is needed for the SPU, and the 12679C for the VGA monitor.

HP Part Number	Price
HP 35199A Rack Mount Shelf	
(1-9 units)	\$79 ea. 
(10-24)	\$72 ea. 
(25-49)	\$68 ea. 
(50-99)	\$70 ea. 
HP 12679B Rail Kit	\$70 ea. 
HP 12131A Keyboard Racking Kit	\$360 ea. 
HP 35199B VGA Monitor Rack Mount	\$125 ea. 
HP 12679C Rail Kit	\$50 ea. 

 For same-day shipment, call HP DIRECT at 800-538-8787

# CABINETS & CABINET ACCESSORIES

## EIA Racks

### HP 46298-Series

- Functional fit with HP instruments
- Same design as HP Design Plus work station furniture
- Quality construction

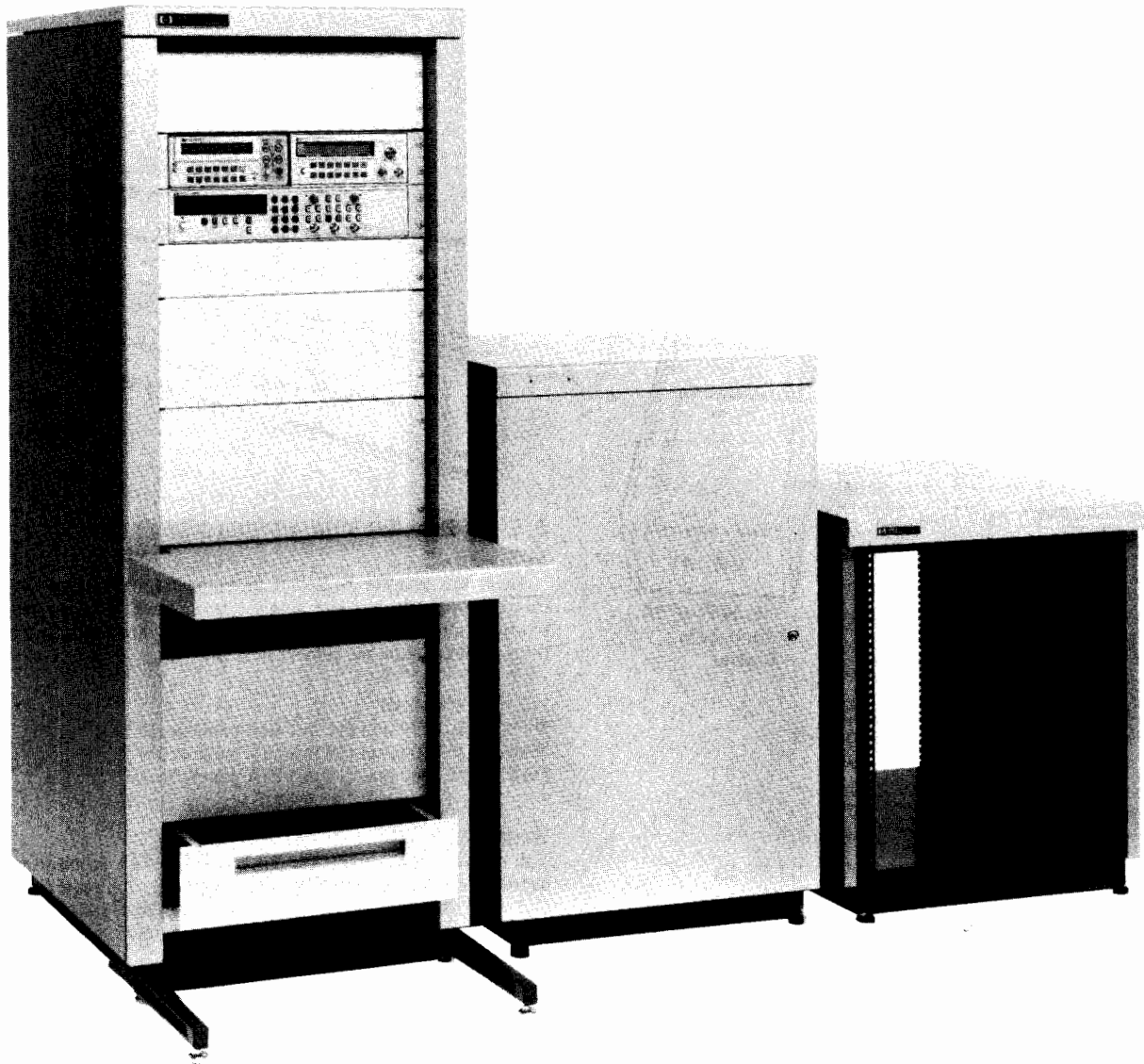

Modularity lets you select only the parts you really need: doors, anti-tip feet, a work surface or a convenient drawer for small system parts.

With the addition of these racks, Hewlett-Packard can now offer you a total system of test instruments, rack cabinets, computers and work stations. All these pieces are designed to be compatible — both in form and function.

These 19-inch commercial/industrial EIA rack cabinets easily accommodate HP test instruments and incorporate the same design elements as HP's Design Plus work station furniture (see page 702). You can create work places which are easy to install, look good and incorporate the latest in ergonomic features.

The rack system is modular. Choose from three heights: 1600mm (63.0"), 1000mm (39.4") or 720mm (28.4"). Then purchase doors, filler panels or other products only as you need them. You can select from blank front doors, ventilated rear doors, front caps, blank filler panels, a sliding drawer and anti-tip feet. We can even provide you with the proper mounting hardware.

The basic rack consists of the frame, two side panels and a top panel. The frame includes a base plate, the four corner struts, to which

the instruments are attached, and a top plate. Everything is manufactured from folded, welded steel. This all-steel, one-piece construction offers incredible strength compared to racks which are merely bolted together. The colors are selected to blend with old and new HP instrumentation. The HP custom paint matches perfectly the newer instrument colors (known as System II Plus).

The racks offer many additional features:

- Convenient lift hooks are included with all cabinets. Use them to lift the empty cabinet into place.
- If you have a large system you can mount instruments both from the front and the rear, since the EIA hole pattern appears on all four corner struts.
- The leveler pads are located at the extreme outer corners of the frame to provide the largest base possible for safety.
- Swivel casters mounted to the base let you roll the racks easily into position.



**Lockable doors**

Blank front and louvered rear doors come in three different sizes for each of the rack heights. Both are lockable with a key, so that the instruments can be protected from unauthorized access. Even with the rear door closed, power to the system can still be furnished.

The rear door is fully ventilated for maximum convection cooling. However, some configurations will require additional ventilation from user supplied fan units.

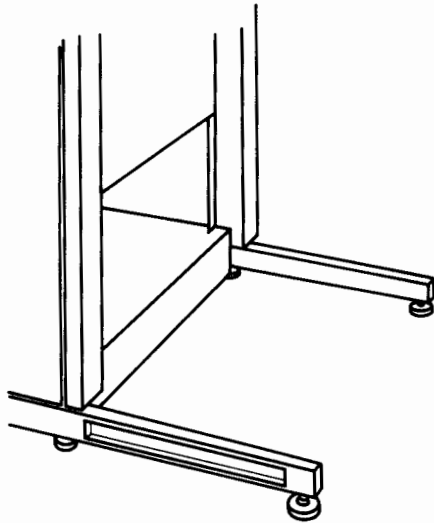

**Anti-tip foot kit**

Each kit contains two feet with leveler pads. The cast steel feet can be mounted either to the front or the rear using existing holes. Bolting the feet to the frame is easy with a wrench and the hardware supplied.

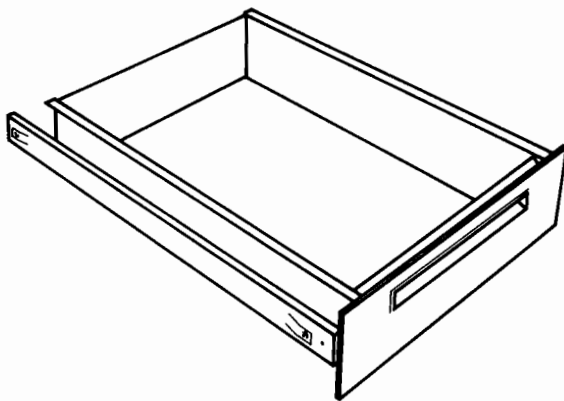

**Sliding drawer**

Keep your instrument manuals or system software close to you in this convenient 5 1/4" high drawer.

Construction is folded, painted sheet metal and it glides easily out on a set of slides. A plastic bezel in the front recess protects your fingers.

**Front caps**

The front caps visually "clean up" the front of the rack by covering the corner struts and the edge of the side panels. You will still have complete access to the instruments and the mounting ears.

The caps are made of folded, painted steel and only a wrench is necessary for mounting. Mounting hardware is included.

**Name plate and mounting hardware**

If you wish, you can attach a Hewlett-Packard system nameplate in the existing indentation in the upper left corner of the racks. The plate features the HP logo, the words "Hewlett-Packard" and "System". These labels are furnished with each rack.

A kit of sheet metal nuts and 10-32 screws is all you need to complete the system. Each rack mount kit comes with hardware to mount the rack ears to the instruments. These screws and nuts mount the ears to the frame. There is enough in the kit to mount the maximum number of instruments in the tallest (1600mm) rack.

**Specifications**

Exterior height: 720mm (28.4"), 1000mm (39.4"), or 1600mm (63.0")

Usable rack height: 553mm (21.8"), 833mm (32.8"), or 1433mm (56.4")

Exterior depth: 800mm (31.5")

Max. instrument depth: 710mm (28")

Exterior width: 600mm (23.6")

Net weights: 720mm: 51kg (113lb)

1000mm: 59kg (130lb)

1600mm: 75kg (166lb)

Hole spacing: EIA standard

Caster load weight: 180kg (400lb) each

**Ordering information**

HP 46298A Rack, 720mm

HP 46298B Rack, 1000mm

HP 46298C Rack, 1600mm

HP 46298E Front door for 720mm rack

HP 46298F Front door for 1000mm rack

HP 46298G Front door for 1600mm rack

HP 46298H Rear door for 720mm rack

HP 46298J Rear door for 1000mm rack

HP 46298K Rear door for 1600mm rack

HP 40112A Front Cap Kit, 720mm

HP 40113A Front Cap Kit, 1000mm

HP 40115A Front Cap Kit, 1600mm

HP 40101A Filler panel, 1.75"

HP 40102A Filler panel, 3.50"

HP 40103A Filler panel, 5.25"

HP 40104A Filler panel, 7.00"

HP 40105A Filler panel, 8.75"

HP 40106A Filler panel, 10.50"

HP 40107A Filler panel, 12.25"

HP 46298M Drawer and slides

HP 46298N Work surface

HP 40100A Anti-tip foot kit

HP 46298R Mounting hardware

☎ For same-day shipment, call HP DIRECT at 800-538-8787

**Price**

HP 46298A Rack, 720mm	\$850
HP 46298B Rack, 1000mm	\$900
HP 46298C Rack, 1600mm	\$975
HP 46298E Front door for 720mm rack	\$175
HP 46298F Front door for 1000mm rack	\$190
HP 46298G Front door for 1600mm rack	\$215
HP 46298H Rear door for 720mm rack	\$175
HP 46298J Rear door for 1000mm rack	\$190
HP 46298K Rear door for 1600mm rack	\$215
HP 40112A Front Cap Kit, 720mm	\$85
HP 40113A Front Cap Kit, 1000mm	\$90
HP 40115A Front Cap Kit, 1600mm	\$95
HP 40101A Filler panel, 1.75"	\$36
HP 40102A Filler panel, 3.50"	\$37
HP 40103A Filler panel, 5.25"	\$38
HP 40104A Filler panel, 7.00"	\$40
HP 40105A Filler panel, 8.75"	\$41
HP 40106A Filler panel, 10.50"	\$42
HP 40107A Filler panel, 12.25"	\$43
HP 46298M Drawer and slides	\$235
HP 46298N Work surface	\$270
HP 40100A Anti-tip foot kit	\$130
HP 46298R Mounting hardware	\$70



# CUSTOMER SUPPORT

## General Information

### Supporting Your Success

You chose HP equipment because it best meets your test, measurement, and computing needs. HP wants you to be successful and we're committed to helping you achieve the best results from your system for years to come. We don't stop serving you once the sale is complete. Our flexible support solutions—in hardware, software, customer education, and consulting services—bring you many benefits. Our support services will:

- Shorten the period between purchase and effective use of an HP product.
- Deepen your understanding of your HP equipment and its capabilities.
- Customize your hardware and software for application-specific requirements.
- Make available unique resources for maintenance and troubleshooting.

Measure the results in greater overall productivity and lower cost of ownership.

Maximizing the return from your equipment investment can be seen as a three-phase process of planning and design, implementation, and operation. Hewlett-Packard offers support services to ensure that you obtain maximum performance from your measurement system during each of these phases.

### Performance by Design

A thorough design will ensure that your test and measurement system performs to your expectations and meets your needs. Whether you're planning a single instrument system or a complete factory, HP can offer you technical assistance through consulting services or design the system for you through project services.

### Support Life Cycle

#### Planning and Design

- Project services
- Consulting
- Educational services

#### Implementation

- Consulting
- Installation services
- Project services
- Educational services

#### Operation

- Hardware support
- Software support
- Educational services

### Smooth Implementation through Knowledge

A thorough understanding of your equipment's capabilities is essential to achieving maximum performance from your investment. That's why we back our products with education courses and materials to ensure that you learn the best way to apply our equipment to your environment.

We also offer installation services to ensure that your system is installed correctly and quickly.

### Continuous Operation through Maintenance

To help you minimize equipment downtime, Hewlett-Packard maintains a worldwide customer service organization staffed with trained engineers and technicians who are backed by factory designers and a large inventory of replacement parts. We will focus the necessary resources to keep your equipment operating at peak performance.

With computers playing a larger role in today's measurement systems, software support plays an essential role in maintaining your system's performance. HP keeps you up-to-date on the latest software improvements to ensure your system continues performing to its maximum potential.

### Support Life

To help you maximize your product's useful life, HP will continue to offer standard support services for as long as feasible. To continue offering these services means managing our trained staff and repair parts inventories to match your needs.

In any event, HP offers support services on all of our products for at least 5 years beyond end of production. Furthermore, on most test and measurement equipment, services are available for at least 10 years beyond the end of production.

In addition, we will make our best effort to repair or calibrate any HP product, whatever its age, even if the product has passed through its support life. Charges will be made on a time and materials basis.

### Support for Your Needs

The following pages provide more details on Hewlett-Packard's wide range of support services. Ask your local HP representative to help you select the services that best meet your needs in maximizing your measurement system's performance.

### Service Selection Guide

Services	Major Benefits	Best Fit
<b>Hardware Support</b> (pg. 723)	<ul style="list-style-type: none"> <li>• HP Customer Return service</li> <li>• On-site service</li> <li>• W30: 3-year customer return repair coverage</li> <li>• W31: 3-year on-site repair coverage</li> <li>• W32: 3-year customer return calibration coverage</li> </ul>	<ul style="list-style-type: none"> <li>• Fast turnaround time</li> <li>• Cost savings</li> <li>• Dependable measurement accuracy</li> <li>• Peak instrument performance</li> </ul>
<b>Educational Services</b> (pg. 726)	<ul style="list-style-type: none"> <li>• Wide variety of courses covering latest HP products and technology</li> <li>• Variety of audiences and skill levels</li> <li>• Flexible delivery options</li> </ul>	<ul style="list-style-type: none"> <li>• Whenever new products or technology are introduced in your environment</li> <li>• New people</li> </ul>
<b>Software Support</b> (pg. 729)	<ul style="list-style-type: none"> <li>• HP ResponseLine software support service</li> <li>• HP BasicLine software support service</li> <li>• HP Software Update Materials service</li> </ul>	<ul style="list-style-type: none"> <li>• Software usage and problem resolution assistance</li> <li>• New software releases</li> <li>• Up-to-date software information</li> <li>• Fast, accurate support</li> </ul>
<b>Consulting Services</b> (pg. 731)	<ul style="list-style-type: none"> <li>• HP Requirements Analysis service</li> <li>• Installation services</li> <li>• Project services</li> <li>• Productivity assistance</li> </ul>	<ul style="list-style-type: none"> <li>• Expert implementation assistance</li> <li>• Quick startup of instrument systems</li> <li>• Increased productivity</li> </ul>

### HP Support Options

The HP Support Options program is a family of services that fits in with your hardware purchasing process. HP Support Options coverage adds to your product's warranty, providing you with HP's quality support for 3 years.

These easily ordered services demonstrate HP's commitment to quality service and low cost of ownership. Competitively priced, they are also more economical than per-incident services. Furthermore, by purchasing HP Support Options coverage, you lock in your cost savings for an extended period.

**Option W30.** Adds to product warranty to provide a total of 3 years of customer return repair service from the time of hardware delivery.

**Option W31.** Adds to product warranty to provide a total of 3 years of next day on-site repair service from the time of hardware delivery.

**Option W32.** Provides 3 years of HP Customer Return calibration service from the time of hardware delivery. Coverage includes scheduled calibration at HP's recommended calibration cycle, as well as calibration after a required repair performed by HP.

### Ordering Information

HP Support Options coverage is available for most HP test and measurement products. These options represent your best opportunity to extend the benefits of product warranty and lock in low support costs for a specified time. They are available at the time of hardware purchase, so you can make one buying decision for both hardware and support, using the same product purchase order. Ask your HP sales representative for more information.

### Customer Return Hardware Support Services

We are committed to maintaining your Hewlett-Packard equipment in peak condition so that it continues to work for you in years to come. Industry experts highly respect our wide range of quality support. If you want to learn more about how we can keep your hardware performing now and in the future, simply take a look at our HP Customer Service Center offerings.

### Technical Expertise

Our maintenance and repair technology comes right out of the original design centers for our products. We know all the inner workings and when things do go wrong we correct them quickly and cost-effectively.

Our technicians are among the most qualified in the industry. Well-supplied, highly automated service centers back them up. Our rigorous training program ensures that our technicians learn new technologies and new products on our time, not yours.



### Extensive Automation

HP Customer Service Centers rely on automated processes to calibrate instruments and diagnose problems. Our investment in automation enhances the quality of repair and repeatability of calibration. This efficiency results in savings for you.

### High In-stock Inventory

Each HP Customer Service Center manages its spare parts inventory so that over 85 percent of required parts are immediately available. We can usually get any other required part within 24 hours.

### Efficient Problem Escalation Management

Hardware and software problems can usually be solved quickly. If special attention is needed, we call upon our worldwide technical and managerial network to rapidly develop a lasting solution.

### Minimum Downtime

We know turnaround time is important to you. No one wants a production line disabled because an instrument is out for service. HP strives to reduce downtime by working quickly and accurately, so you get back to business promptly. We are even willing to specify our turnaround time. Here are our commitments:

### Five-day service for instruments

We will repair or calibrate any HP instrument covered by an HP service agreement in most parts of the world within 5 working days of receiving it.

### Three-day service for office products

We will repair any HP office product covered by a repair agreement usually within 3 working days of receiving it. For more information, please contact your HP Customer Service Center.

### An Outstanding Array of Services

Whatever your needs, we aim to be as flexible as possible in meeting them. We offer repair and calibration, to MIL-STD or commercial requirements, on a per-incident basis and under each of our agreement services:

- HP Support Options program
- Repair agreement
- Calibration agreement
- Full service agreement

In addition, we will make our best effort to repair or calibrate any HP product, whatever its usage, even if the product has passed through its support life.

In summary, HP's service programs offer the benefits of factory support, highly trained technicians, automated repair and calibration, problem escalation management, engineering upgrades, and fast turnaround time. We're proud of our capabilities and customer service record.

# CUSTOMER SUPPORT

## Hardware Support (cont'd)

### A Variety of Service Agreements Comprehensive and Economical

Our services maximize the performance of your HP equipment. You can choose an HP support agreement that best fits your application and type of equipment. With HP's service agreements you:

- Know in advance exactly what you'll be paying for an entire year of support.
- Get your equipment calibrated according to factory-recommended procedures and timetables.
- Enjoy the security of continuous coverage by experienced HP personnel.

Take a look at the ways HP's service agreements can keep your equipment at peak performance.

#### Repair agreement

Our repair agreement covers all parts and labor resulting from equipment failures. Similar to an extension of your product's warranty, it is significantly more economical than equivalent per-incident repairs on instruments and office products. Products covered under the agreement are repaired within the timespan stated in the agreement, generally 3 to 5 days. Return freight, parts, and labor are included. [Please note: agreements do not cover failures resulting from abuse or damage.]

#### Calibration agreement

Periodic calibrations at factory-recommended intervals lead to confidence in measurements. The factory-suggested timetable of our calibration agreement results in a history of more accurate measurements. In addition, the agreement is much more economical than purchasing per-incident calibration. If you change instrument use or operating conditions often, we can provide calibrations at an interval you request. Return freight is included, of course.

#### Full service agreement

Our full service agreement combines both repair and calibration coverage, at even greater savings. It covers both unanticipated equipment failures and periodic calibrations. It also covers any post-repair calibrations needed to ensure factory-specified accuracy.



#### HP ExpressCal Service

Quality just got faster. HP ExpressCal service enables you to schedule calibrations in advance to achieve minimum downtime. Most scheduled calibrations are completed within 24 hours. HP ExpressCal service is provided at no charge for products covered under calibration or full service agreements, or under HP Support Option W32.

#### Military standard agreements

MIL-STD-45662 calibration and full service agreements are available for approximately 1,300 HP instrument products in the United States. Furthermore, most of our calibrations comply with the "A" version of the standard. Other government certification programs are available in other parts of the world. Discuss your needs with your local HP Customer Service Center representative.

#### Volume service agreement discounts

You may be eligible for a volume service agreement discount. Call your local HP Customer Service Center for details.

### Service Agreement Selection Guide

	Features	Major Benefits	Best Fit
<b>Repair Agreement</b>	<ul style="list-style-type: none"> <li>• Complete repair coverage</li> <li>• Fixed annual price</li> <li>• No parts exclusions</li> <li>• Preventive maintenance and engineering upgrades when appropriate</li> <li>• Return surface shipment included</li> <li>• Priority service, 5 days or less</li> </ul>	<ul style="list-style-type: none"> <li>• Single, budgetable expense</li> <li>• Significant savings over equivalent per-incident service</li> <li>• Elimination of quotation approval delays</li> </ul>	<ul style="list-style-type: none"> <li>• Instruments not requiring calibration</li> <li>• Frequently used products</li> <li>• Critical applications</li> <li>• Office products and peripherals requiring cost-effective coverage</li> </ul>
<b>Calibration Agreement</b>	<ul style="list-style-type: none"> <li>• Periodic calibration at HP-recommended intervals</li> <li>• Fixed annual price</li> <li>• NIST traceability</li> <li>• MIL-STD-45662 option</li> <li>• Return surface shipment included</li> <li>• Customer-specified cal cycle for an adjusted price</li> <li>• Priority service, 5 days or less</li> </ul>	<ul style="list-style-type: none"> <li>• Dependable measurement accuracy</li> <li>• Significant savings over equivalent standard calcs</li> </ul>	<ul style="list-style-type: none"> <li>• Accuracy critical applications</li> <li>• Traceability required</li> <li>• All instruments requiring regular calibration</li> <li>• MIL-STD-45662 compliance required</li> </ul>
<b>Full Service Agreement</b>	<ul style="list-style-type: none"> <li>• Features of repair and cal agreement combined</li> <li>• MIL-STD-45662 option</li> <li>• Priority service, 5 days or less</li> </ul>	<ul style="list-style-type: none"> <li>• Peak instrument performance</li> <li>• Significant savings over equivalent per-incident services or repair and cal agreements combined.</li> <li>• Lower self-support parts inventory and training costs.</li> <li>• Less demand on self-support personnel</li> </ul>	<ul style="list-style-type: none"> <li>• Most instruments</li> <li>• Critical applications</li> </ul>

**HP Success Line  
On-site Hardware Support  
Priority Plus support**

HP SuccessLine service provides high-quality on-site support that enables you to maximize instrument and measurement system uptime. The flexible response times and coverage periods allow you to tailor support to your service needs, while providing superior value for your money. Service includes an account-assigned customer engineer (CE) who becomes familiar with your environment and takes personal responsibility for managing your measurement system's maintenance program.

Also, your CE will perform preventive maintenance on a regular basis, scheduled in advance, to maintain your system at its optimal performance specifications.

This service level provides coverage 24 hours a day, 7 days a week. It provides maximum coverage hours and days, and HP's best possible response time. Customers within 100 miles of an HP Support Responsible Office receive an on-site visit within 4 hours.

**Priority support**

This service level provides coverage from 8 am to 9 pm, Monday through Friday (excluding HP holidays). This coverage allows all scheduled maintenance services to be performed after normal working hours. Customers within 100 miles of an HP Support Responsible Office receive an on-site visit within 4 hours.

**Next Day support**

This service level provides next day, on-site service coverage from 8 am to 5 pm Monday through Friday (excluding HP holidays) for customers within 100 miles of an HP Support Responsible Office.

**On-site calibration service**

HP also offers the convenience of on-site calibration service for instruments and measurement systems. Measurements made during calibration of your equipment are traceable to the U.S. National Institute of Standards and Technology (or other international standards organization, where applicable). Military standard options are also available.

**System installation services**

When you purchase an HP computer or measurement system, support services begin even before system installation. A customer engineer routinely provides site planning, site environmental survey, and installation services.

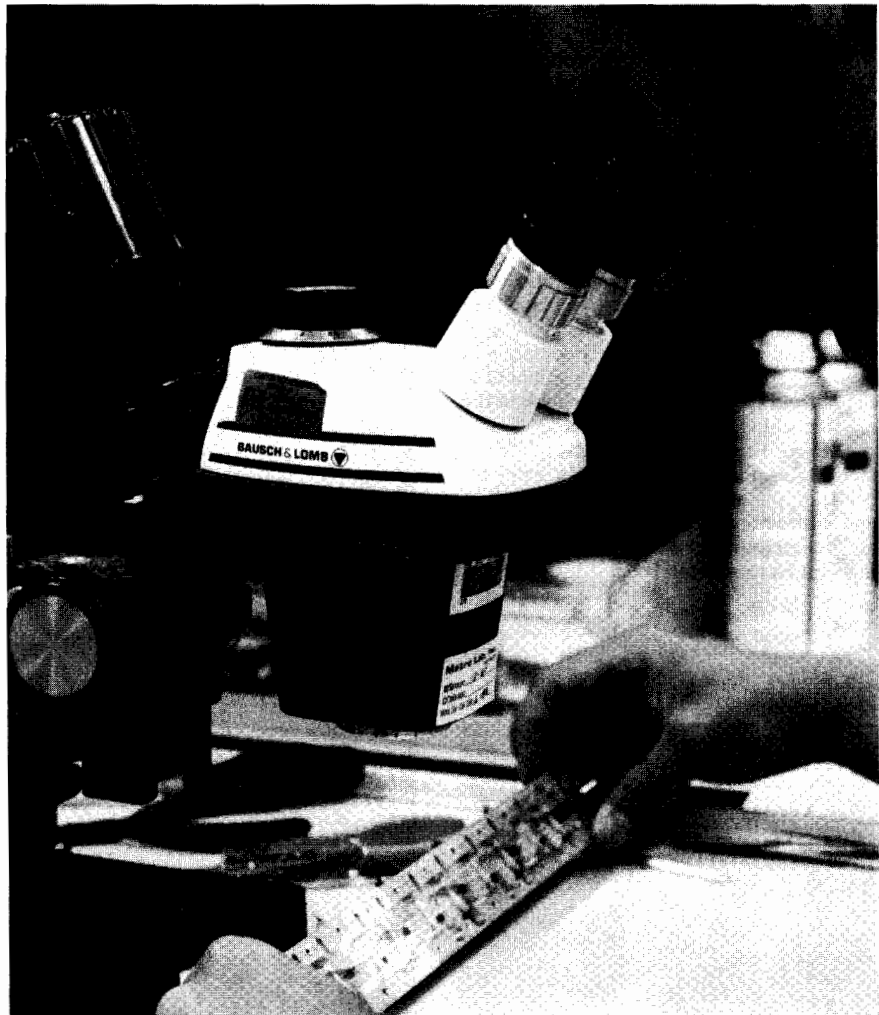

Instrument and measurement system support selection guide for HP SuccessLine service levels

	Priority Plus	Priority	Next Day
Coverage hours	24 hours a day, 7 days a week	8 am-9 pm* Monday-Friday	8 am-5 pm Monday-Friday
Response time	Best response, not to exceed 4 hours	Best response, not to exceed 4 hours	Next working day
Usage environment	Highly critical; continuous user operations	Urgent; no substitute equipment	Less critical; substitute equipment available

\* Available in most locations. Check with your local HP office for detailed coverage hours.

© 1997 Hewlett-Packard Company  
 HP SuccessLine is a registered trademark of Hewlett-Packard Company.  
 All other trademarks are the property of their respective owners.

# CUSTOMER SUPPORT

## Educational Services

### HP Educational Services

We are committed to offering training that will permit you to get the best possible use of Hewlett-Packard equipment. We recognize that both initial instruction and ongoing education contribute to your success: that is why we offer courses in operation, applications, and software and hardware maintenance for HP instrument and computer products.

### Quality Training

#### Our instructors understand your industry

They speak the language. We make sure our instructors have a deep understanding of the subject and can effectively explain—in clear, concise terms—everything you need to know, from specialized test techniques to the physics behind the measurements.

Backing them up are HP class-development teams. Product specialists, industry experts, curriculum engineers, course writers, and instructors develop training materials and design courses with the goal of maximizing your learning experience.



### Courses That Work for You

Our courses are consistently updated to keep pace with evolving technology and industry changes. HP designs instructional materials—including student manuals and lab and instructor materials—to serve as long-term references. A course cannot cover everything, but it can help guide your thinking on the subject matter. Our texts will help you keep in focus long after the class has ended.

#### Limited class sizes

Classes are limited to six to ten students. We believe small classes encourage closer in-

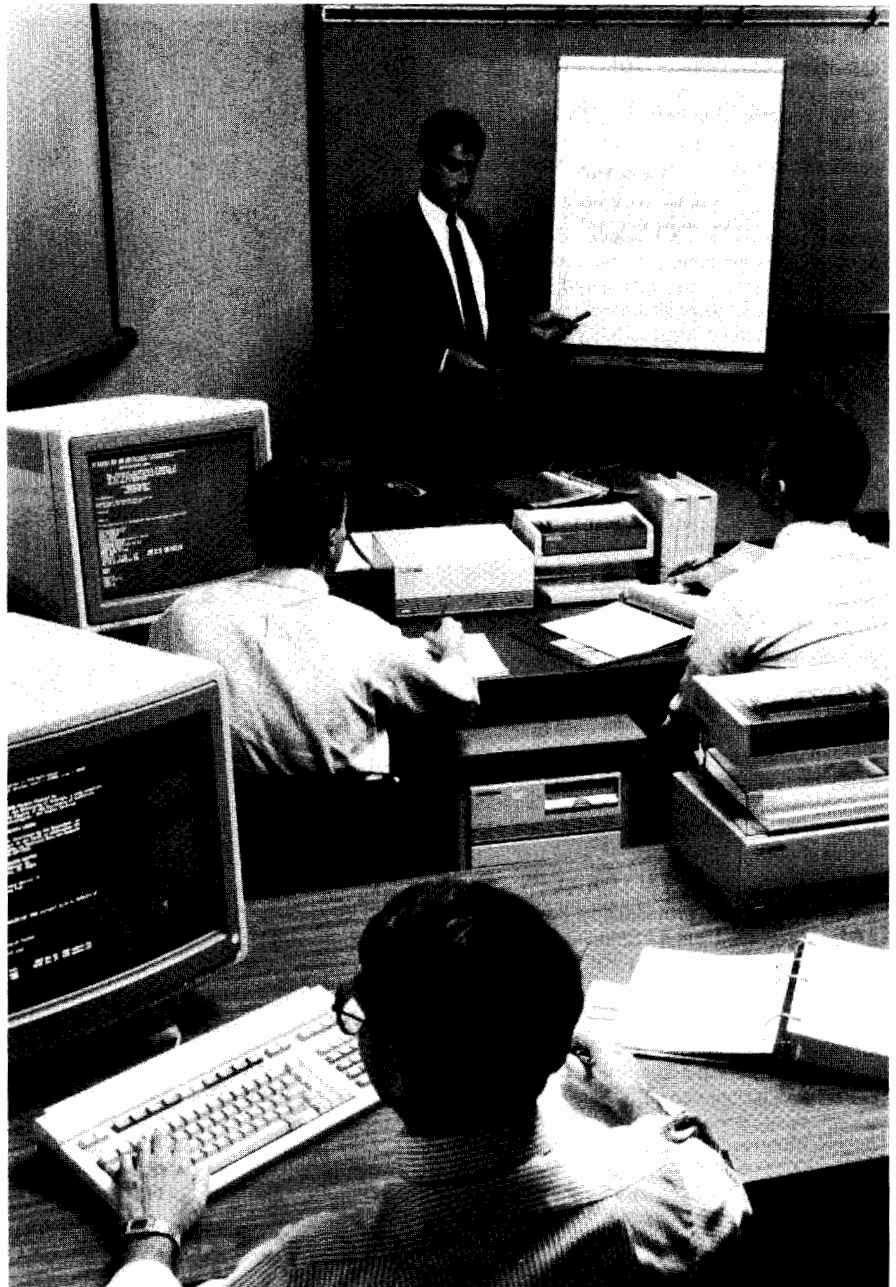

teraction with the teacher and other students, thus permitting students to share learning experiences and applications expertise.

#### It's not all books

Hands-on training is important to your success. That is why we provide lab equipment in our classes. Each course has lab time as a key training benefit.

#### The payback

Our experience shows that you will learn faster with HP education courses. The benefits are twofold: the equipment can be used sooner and the time you would have spent on independent learning can be used for other opportunities.

### Worldwide Training

#### Worldwide training center network

HP has training centers throughout the world, with classes in continuous progress. Training schedules are published regularly.

#### On-site training

All HP courses can be scheduled and taught at your site. This option might prove more attractive to you, bringing the advantages of training in a familiar environment with your own equipment.

#### Off-schedule training

Additional HP classroom courses can be arranged beyond those published in the local training schedule. These classes can accommodate your emerging training needs.

### HP Customer Education Center Locations

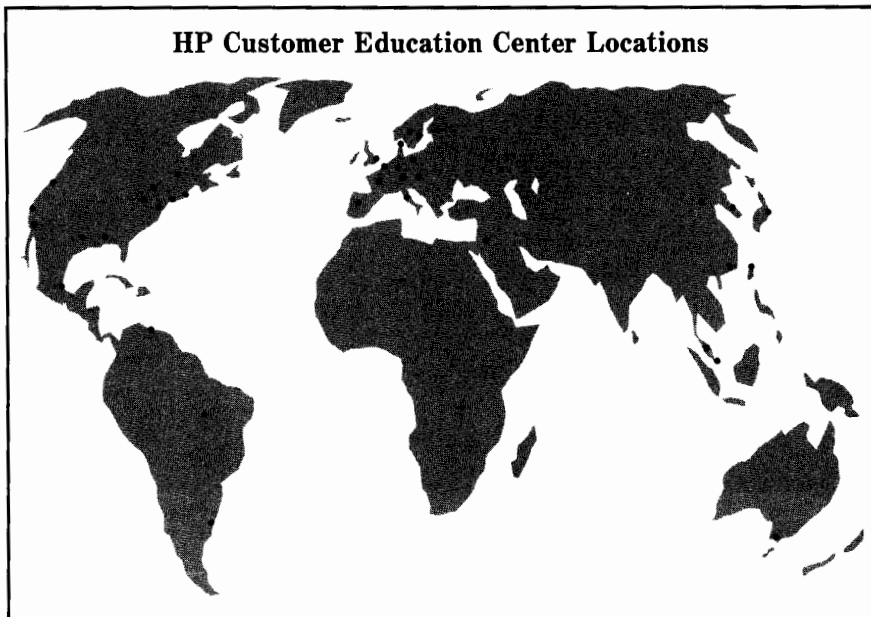

- Argentina
- Australia
- Austria
- Belgium
- Brazil
- Canada
- China
- Denmark
- Finland
- France
- Germany
- Hong Kong
- Israel
- Italy
- Japan
- Korea
- Malaysia
- Mexico
- Netherlands
- Norway
- Singapore
- Spain
- Sweden
- Switzerland
- Taiwan
- United Kingdom
- Venezuela
- United States - Atlanta
- Boston
- Chicago
- Dallas
- Detroit
- Los Angeles
- New York
- San Francisco
- Washington, DC

#### Customized classes

We can meet special training needs by developing custom training classes. These changes may include modification of class materials, development of modular training, development of special labs, integration of new sections in the course, and even the development of entirely new classes.

#### Specialized training materials

HP education is typically based on classroom training, led by professional instructors with solid engineering experience. Other HP training formats include computer-based training, videotape sessions, satellite-broadcast instructions, and self-paced training modules.



### Test and Measurement Curriculum

#### HP-IB Instrument Control and Data Acquisition

HP 05096A	3 days	SA/SD for Test and Measurement Software
HP 34800A+24D	3 days	Developing Test Plans Using FTM/300
HP 50011C	4 days	HP-IB Instrument Programming Using Series 200/300 BASIC
HP 51409A	1 day	HP-IB Theory
HP 51412A	1 day	HP-IB for MS-DOS® Personal Computers

#### Languages

HP 31112A	5 days	Introduction to Pascal
HP 31113A	5 days	HP Pascal for Advanced and System Programming
HP 31124A	5 days	Introduction to Ada/300 Development System
HP 35130B	5 days	Programming in C Language
HP 50698A	5 days	Programming in FORTRAN 77
HP 98501B	5 days	Introduction to Workstation BASIC
HP 98510D	5 days	Series 200/300 BASIC Operating and Advanced Programming
HP 98511C	5 days	Series 200/300 Pascal Operating and Advanced Programming
HP 98880A	3 days	HP BASIC/UX Programming and Operating

#### General Purpose Instrumentation

HP 1631D+24D	2 days	HP 1631A/D Logic Analysis Measurement Techniques
HP 18347A	1 day	HP 4951C Protocol Analyzer User Course
HP 35629A	3 days	HP 3562A Users Course
HP 3852A+24D	4 days	HP 3852S User Training Course
HP 50015A	3 days	Data Acquisition and Control Fundamentals
HP 55280A+24D	1 day	Basic Laser Measurement Training
HP 55283A+24A	1 day	Advanced Laser Measurement System Training
HP 6944S+24D	3 days	Multiprogrammer System User Course
HP 6954A+24A	3 days	HP Series 6900 Multi-programmer

#### Microwave

HP 11776A+24D	2 days	HP 11776A Waveform Generation Language Users Course
HP 3048A+24A	2 days	HP 3048A Phase Noise Measurement System
HP 50740A	4 days	Microwave Fundamentals Course
HP 50740B	4 days	Microwave Fundamentals Course
HP 50740C	3 days	Microwave Fundamentals Course
HP 8510B+24D	3 days	Basic Network Measurements Using the HP 8510B Network Analyzer
HP 85101B+24D	2 days	Advanced Programming for the HP 8510 Network Analyzer
HP 85150A+24D	2 days	Discovering the HP Microwave Design System
HP 85668A	4 days	HP 8566/67/68 Spectrum Analyzer Operating and Programming Course
HP 8753B+24A	1 day	HP 8753B RF Network Analyzer Course
HP 11949A	2 days	Designing For EMC Seminar

#### HP-UX

HP 50710A	5 days	Programming with HP-UX System Calls
HP 51432A	5 days	HP-UX Fundamentals for General Users
HP 51433A	5 days	HP-UX Shell Programming for General Users
HP 51434B	5 days	Fundamentals of HP-UX
HP 51435A	5 days	HP-UX Text Editing Tools
HP 51438A	2 days	SCCS and make
HP 51439A	1 day	Advanced Editing with vi
HP 51440A	3 days	Document Preparation
HP 51489B	2 days	HP-UX Basics for Application Users

# CUSTOMER SUPPORT

## Educational Services (cont'd)

### HP-UX System Administration

HP 22861B	2 days	ARPA/Berkeley Services for the HP 9000 Series 300 and Series 800 Systems
HP 22862A	2 days	Administration of NFS and Yellow Pages
HP 35073A	3 days	HP-UX System Administration for the HP 9000 Series 200
HP 35129B	3 days	HP-UX System Administration for the HP 9000 Series 500
HP 50722A	3 days	HP-UX System Administration for Application Users
HP 51436C	5 days	HP-UX System Administration for the HP 9000 Series 300
HP 51482C	5 days	HP-UX System Administration for the HP 9000 Series 800

### Board Test/Semiconductor Test

HP 4062C+24A	3 days	HP 4062C Operating and Programming Training
HP 4062UX+24A	3 days	Operations and Programming Training
HP 44531A	10 days	HP 3060A/61A/62A Users Course
HP 44584+24A	1/2 day	HP 3060 Enhancement Training
HP 44850A	5 days	HP 3065 Advanced Users Course
HP 44852A	10 days	HP 3065 Board Test System Users Course
HP 44853A	8 days	HP 3065 AT Training
HP E1031A	10 days	HP 3070 User Fundamentals
HP E1024A	5 days	HP 3070 Advanced Digital Class
HP E1287A	5 days	Introductory Training for HP 82000
HP E1289A	2 days	HP 82000 Introductory Training

### Microprocessor Development

HP 64100A+24D	2 days	HP 64000 System Concepts and Measurements
HP 64120T	2 days	HP DesignCenter 64000-UX User Course
HP 64121T	1 day	HP-UX for HP 64000-UX Users
HP 64620S+24D	1 day	HP 64000 State/Software Analysis

### Design Systems

#### Design capture and simulation

HP 74001A	3 days	HP EE DesignCenter System Administration
HP 74201A	2 days	HP Design Capture System Overview
HP 74202A	3 days	HP Design Verification Interface Users Course
HP 74203A	3 days	Introduction to HILO Modeling

#### Printed circuit board (PCB) design

HP 50959A	1 day	Using SRM from BASIC and Pascal
HP 74300A	3 days	Introduction to HP EGS
HP 74301A	2 days	PCB Design with HP EGS
HP 74302A	3 days	Customizing with HP EGS
HP 74495A	5 days	Introduction to HP PCDS

#### Mechanical design (ME)

HP 74836T	5 days	HP ME Series 30 Users Course
HP 98363B+24D	4 days	HP ME Series 10 Users Course
HP 98365U+24D	3 days	Customizing HP ME Series 10

#### Telecommunications

HP 37050S+24A	5 days	HP 37050S User and System Manager Course
HP 37190A	8 days	HP 37100S Operator and Management Course
HP 37191A	3 days	HP 37100S Operator Training

Refer to the *Education Catalog* for detailed descriptions of the above classroom courses as well as available self-paced training and hardware maintenance training.



HP Education . . . Engineered for Your Success

#### Schedules and literature

Course schedules are published three times a year (for regularly scheduled classes). Contact your Hewlett-Packard sales office or HP Customer Education Center for a copy of local training schedules.

Your sales office can also provide the following training literature:

**Course data sheets.** Every HP class has a data sheet that describes the course in detail. Included are key topics, target audience, course outline, prerequisites, and ordering information.

**Education course schedule.** HP training schedules are published throughout the world and list class schedules for each HP Customer Education Center, by country.

**Overview folder.** This folder describes some of the benefits you receive by attending an HP class. The folder includes a pocket for other marketing literature tailored to your specific interests.

**Education catalog.** The catalog presents information on the entire HP course range, including curriculum flow diagrams, course objectives, outlines, and course content. It is your tool for planning the best possible education for yourself and other members of your organization.

**Curriculum path brochures.** These brochures show the curriculum layout and give class descriptions for the following markets:

**HP-UX curriculum path brochure.** This brochure shows the HP-UX curriculum layout and gives course descriptions.

**Maximize your training dollars.** This brochure highlights the benefits of HP customer education in terms of accelerated learning, productivity gains, and time and cost savings. A worksheet is included to help you quantify the payback available to your organization from HP training.

#### How to Order

To register for any HP class in the U.S., call (800) HP CLASS (800-472-5277).

Outside the U.S., contact your closest HP Customer Education Center or local HP sales office.



### HP's Software Support Services

Ongoing success with instrumentation products requires up-to-date information and software. Year after year, industry experts rate Hewlett-Packard as a leader in high-quality product service and customer support. HP offers two software support services for instrumentation products. HP BasicLine software support is an enhanced self-support product. HP ResponseLine software support provides complete software maintenance through the HP Response Center.

#### HP BasicLine

HP BasicLine service for instrument products delivers current, comprehensive support information, with electronic access to information and the right to use HP software updates.

You can use the electronic databases to obtain current information on the latest HP products, support programs, and training classes. You can also use powerful search mechanisms to solve support problems for many HP instrument products. The combination of valuable support data and powerful search mechanisms adds up to increased productivity.

#### Increase System Productivity through Software Updates

Hewlett-Packard continuously enhances HP software products through periodic software updates. These software updates include known defect repairs and may include additional functional and performance improvements. HP BasicLine service includes the right to use updates for all licensed software on a single system. This ensures that your software and manuals keep current and that you benefit from any fixes or enhancements that Hewlett-Packard has provided.

#### Increase System Uptime through Access to HP's Worldwide Support Network

Hewlett-Packard's electronic support information has been developed through the worldwide HP Response Center network, which is also tied back to HP manufacturing divisions. This means that information developed halfway around the world, which could prevent a problem in your system, is available to you through a dial-up modem and an HP-compatible ASCII character mode terminal or HP-compatible terminal emulator.

In addition, your system and operations staff can tap into knowledge gathered from throughout the HP organization. The on-line *News Page* brings you the latest news on product announcements, support services, new programs, and training classes. This information, along with service alerts on critical problems, stays current through weekly updates by HP's worldwide support, sales, manufacturing, research and development, and marketing organizations.

#### Obtain Direct Access to Valuable Problem-solving Information

HP's software status bulletin, engineering notes, and application notes are all available electronically. The bulletin provides a complete listing of all reported software and manual defects and information for repair or workarounds. Engineering notes feature HP's recommended solutions to customers' problems, to help you solve problems quickly. Application notes present usage assistance and configuration information. Regular database updates provide you with current problem-solving and application information.

#### Reduce Time Locating Essential Information

The database access software allows you to explore interactively all product and application information. Whether you are using the powerful keyword search or the menu-driven browse facility, you quickly get to the appropriate reference. And, because the databases consolidate information from multiple sources, one search brings you everything on your topic of interest.

#### HP ResponseLine

HP ResponseLine service for instruments provides comprehensive software maintenance. In addition to all of the features of HP BasicLine service, you receive telephone assistance to resolve software problems and questions about product usage. You also receive fast, direct answers via access to HP's maintained electronic database. The HP Response Center network brings together the worldwide resources of HP for software maintenance.

#### Obtain Rapid Response to Problems and Questions

HP ResponseLine service offers unlimited telephone assistance for normal software usage, clarification of documentation, and resolution of software problems. With timely answers to questions, you gain full advantage of your HP software's features and functions. In addition, HP ResponseLine service entitles you to the convenience of electronically submitting questions to the HP Response Center during your on-line HP SupportLine sessions.



# CUSTOMER SUPPORT

## Software Support

### Increase System Uptime through Support Escalation Management Program

In the event that the HP Response Center cannot solve your software problem remotely, HP's well-defined escalation procedure mobilizes resources necessary to resolve the problem quickly. Using advanced-technology diagnostics and worldwide problem information databases, HP specialists isolate and analyze your software problems and then develop and implement the best solutions.

### Specific Support Services

Your local HP systems engineer can also work with you to develop HP software support services that are specific to your instrumentation and needs.

Below are a number of the test and measurement products for which HP offers software support services:

#### Microwave/Design Automation

- HP 85150B Microwave design system  
 HP 85180A High-frequency structure simulator

#### Semiconductor Test

- HP 4062B/C/UX Parametric test system  
 HP 16279A Test management shell/TekBase  
 HP 16276L Interactive measurement and analysis software  
 HP 944XX HP Transistor Characterization (TECAP)  
 HP 9480 Analog LSI test system  
 HP 82000 IC evaluation system

#### Board Test

- HP 3070 Board test products  
 HP 3065C/CL/CX/ST Board test products

#### Signal Analyzers

- HP 35680A Instrument BASIC Analysis Pack  
 HP 35681A HP VISTA  
 HP 35630B HP SINE  
 HP 35631B HP Modal data manager  
 HP 3566A/67A PC-based dynamic signal analyzers  
 HP 35634A PC-DSA measurement software  
 HP 35636A Order tracking software  
 HP 35637A Swept sine software

#### Controllers/CAT

- HP 3852A Data acquisition/control unit  
 HP 3235A Switch/test unit  
 HP 75000 Family of VXI products  
 HP 34806X Functional test manager software  
 HP E2000A Interactive test generator software

#### Telecom/Datacom Test

- HP 4954A WAN protocol analyzer  
 HP 4972A LAN protocol analyzer  
 HP 4990A HP ProbeView software  
 HP 37011A Telecom system software



### Test and Measurement Productivity Assistance Service Productivity Assistance Services

As measurements and technology have become more complex, HP's equipment has become more sophisticated. Now that you've invested in the best instrument, let HP help you maximize your return. A wide range of productivity assistance services, part of the HP ConsultLine program, helps you fully take advantage of your equipment's capabilities. We help you quickly advance from installation to optimal system use. Whether you need a few hours of guidance from an experienced systems engineer or a custom plan, the Application Engineering Organization and HP Project Centers are ready to help through the following services.

#### Startup Productivity Assistance

When your measurement system arrives and your project is on a tight schedule, sometimes there is not enough time to study all of the manuals. Even though you or your people may be experts, you still might have questions about the best way to apply these new and powerful capabilities to your specific application.

HP's startup productivity assistance provides you with quick answers to your questions, letting you harness the power of your measurement system. One of HP's trained, experienced system engineers will come to your site, at your convenience, to work with you on your specific questions.

For example, startup productivity assistance service can be used to help you in the following areas:

- System setup, installation, and initialization
- Controller, instrument, and system interfacing
- Measurement techniques

Startup productivity assistance is available on a half-day and daily basis, which provides flexibility to meet your needs.

#### General Problem Solving

A few hours with an expert can often help you overcome measurement system road blocks, or help you fine-tune your system for optimal speed and accuracy. Our trained system engineers can show you the latest tips and techniques for maximizing your HP measurement system's performance, as well as assist you in customizing and integrating the system in your environment.

#### HP Project Center Services

For larger scale, complex requirements, HP Project Centers can provide you with custom solutions. Backed by the full resources of Hewlett-Packard, HP Project Center teams deliver on-time, on-budget solutions to meet your specifications. Look to our experts to save the time, expense, and worry of devising custom solutions yourself.

HP Project Center expertise in measurement automation results from extensive experience in test-system analysis and design. HP Project Center engineers are also adept in the design of other applications, including data acquisition and control, in-circuit and functional circuit testing, semiconductor testing, and microwave/RF testing.

#### How to Order

Your HP sales representative can help you select a combination of support services to help you gain maximum use from your HP system in the minimum time possible. Ask your local HP sales representative for more details.

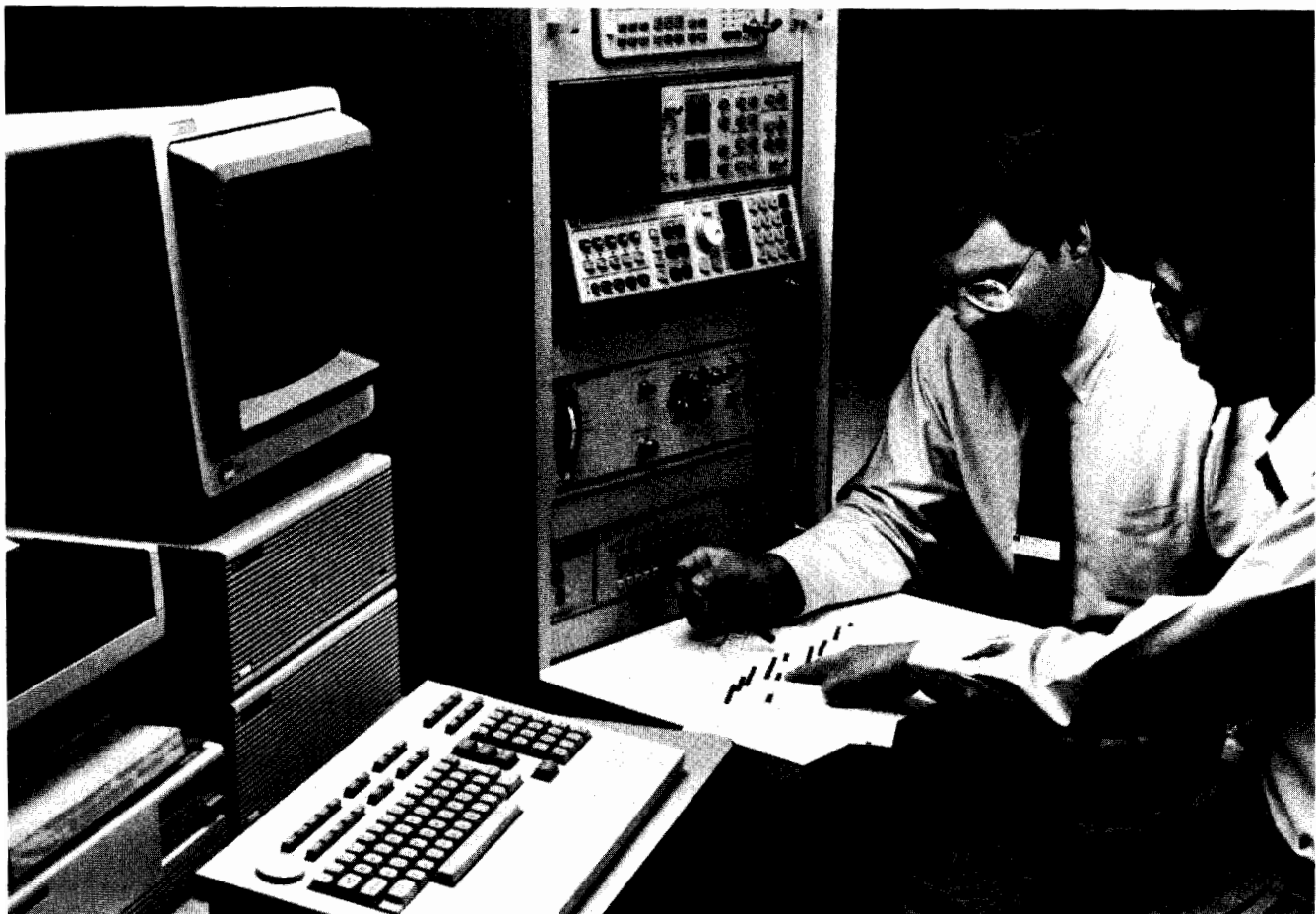



**Don't Delay the Project Waiting for Basic T&M Products—Call HP DIRECT.**

When you know what you need and you need it in a hurry, look for this icon. ☎ It identifies products that you can order from HP DIRECT as quickly as making a toll-free phone call.

In fact, when you call HP DIRECT in the United States by 4 p.m. your time, we will ship your order by 7 p.m. *that same day*. You are sure to get your order within seven working days.

How can HP DIRECT provide such service? By keeping the products you need in-stock 99.7% of the time\*. So our stock answer to your every order can always be "Yes."

**HP DIRECT Has What You Need, When You Need It.**

- **Full range of products**, from BNC cables to protocol analyzers.
- **Thorough documentation**, including product descriptions, pricing and ordering information.
- **Helpful, toll-free telephone ordering.\*** Call us anytime Monday through Friday, from 9 a.m. to 5 p.m., your local time.
- **Same-day shipping\*** when you call by 4 p.m. Overnight delivery is also available for a nominal fee. And we ship within 24 hours of receiving your verbal P.O.
- **30-day, money-back guarantee.** Count on HP DIRECT for high-quality test and measurement products. But you can also count on us for a full refund if you're not satisfied.

\*This same-day shipment service is available within the United States only.

## Instruments Now Catalog Takes the Wait Out of Basic T&M Orders.

Use the **Instruments Now** catalog whenever you need basic test and measurement products in a hurry.

**Instruments Now** puts complete product, pricing and ordering information at your fingertips. It offers full descriptions with photographs, flow charts, specifications, and compatibility and selection guides. Product number and alphabetical indexes help you locate products quickly.

HP DIRECT also publishes the **Computer Users Catalog** of supplies and accessories, and the **Documentation Index** of manuals, binders, books and guides for HP hosts.

Just call for our catalogs—we'll send them to you at no charge.

### It is easy to use HP DIRECT anywhere in the world.

To order products from HP DIRECT, call any one of the following telephone numbers.

Denmark	80 30 16 40
France	(1) 69 86 17 25
West Germany	01 30-33 22
Italy	02-92 103 301
Netherlands	06-0501
Spain	(91) 637 40 13
Sweden	(08) 7 50 24 00
Switzerland	(057) 31 24 90
United Kingdom	0734-441212
United States	1-800-538-8787

### Order HP DIRECT Catalogs

Order HP DIRECT catalogs by calling your local HP sales office (see page 737) or by calling the telephone number listed on this page for your country. Make your request by catalog title, country, and one of the following publication numbers:

<b>Instruments Now Catalog</b>	5954-0193
<b>Computer Users Catalog</b>	5953-2450
<b>Documentation Index</b>	5953-2460

**HP DIRECT**  
**800-538-8787**  
*Our Stock Answer Is "Yes"*

### Fast-Ship Service in the U.S.

Throughout the pages of this catalog you will notice the telephone symbol. This symbol identifies a wide variety of products available to you through the U.S. **Fast-Ship Service**, as well as through your local HP Sales Office:

- Test and Measurement Accessories
- Cables and adapters
- Microwave Accessories
- Basic Instruments
- Rack Mount Hardware & Cabinets
- Data communications
- Handheld calculators and computers
- Personal computers and software
- Peripherals and terminals
- Furniture and accessories
- Printers
- Plotters and their supplies
- Magnetic media.

### What Makes Fast-Ship Convenient?

When you call our **HP DIRECT** Phone Order Service weekdays by 4 p.m. your time, you receive immediate confirmation of product availability, pricing and delivery. And remember, our prices include regular UPS or truck delivery. Expedited air service is also available. We usually can charge your order with an HP DIRECT Open Account (P.O.s), or with your VISA, MasterCard or American Express credit card. We want you to be absolutely satisfied with our products. All supplies and accessories are designed and tested to meet the high quality standards you expect from Hewlett-Packard. All products in our catalogs come with our guarantee of satisfaction. Any product in our catalogs not meeting your expectations can be returned — no questions asked.

# INSTRUMENT FINANCING

## Rental, Leasing And Gradual Purchase Plans

### Match Your Payments to Your Revenue Stream

Renting, leasing, or financing offers these important benefits: (1) you acquire the latest technology without a large cash outlay; (2) short-term projects can be managed economically; (3) upgrading and adding-on is easy; and (4) "off-balance sheet" financing can allow you to overcome tight capital budget restrictions.

### Why HP?

HP uses its low cost of funds to offer you very competitive rates. If you need to buy the equipment, a generous equity accrual option allows you to receive credit for your previous payments. Your equipment is backed 100% by the company that knows it best. And HP provides a flexible approach to scheduling payments - monthly, quarterly, even seasonally.

### To Learn More

Contact your HP sales representative to learn how an HP Financing plan can be tailored to meet your needs.

### A Full Range of Choices

This chart indicates the broad range of plans available in the U.S. Similar plans are available worldwide. Contact your local HP representative for more information.

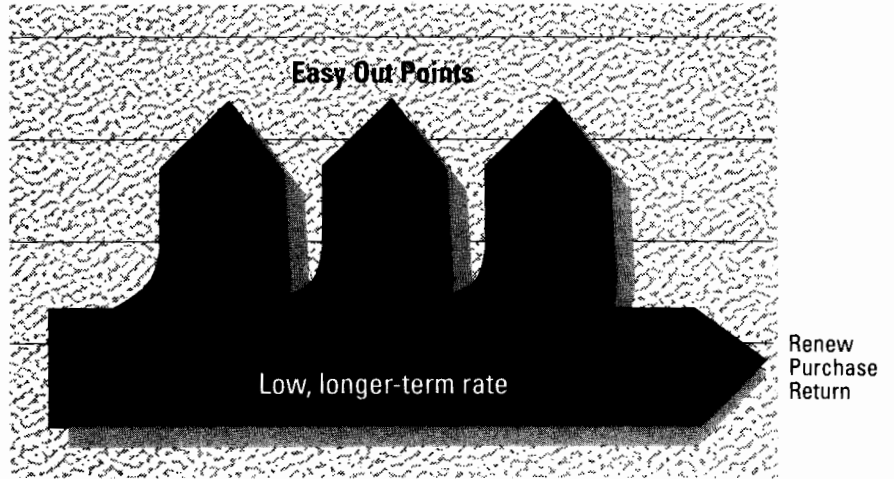

### HP EasyRent.

HP EasyRent was specifically designed for instrument customers who need a cost-efficient path through tight capital budget constraints. This popular rental plan combines the low rate of a longer-term plan with early exit options, called "Easy Out Points," to achieve the ease of a shorter-term plan.

HP EasyRent provides a powerful way to acquire HP instrumentation, as you need it.

HEWLETT-PACKARD FINANCING PLANS				
	Key Benefit(s)	Term	Ownership	Purchase Option
HP EasyRent	Low cost per month. Good flexibility.	36 months (exit options at 12 and 24 months)	HP	65% <sup>1</sup> payment credit
HP Rental Plan	Provides maximum flexibility/ shortest commitment.	12 months	HP	65% payment credit
HP Operating Lease	Payments can be expensed via "off-balance sheet" financing.	12-48 months	HP	65% payment credit
HP Lease with Option to Purchase	Lowest monthly payment.	60 months	HP	10% of amount financed
HP Payment Plan	Buy without a large cash outlay. No down payment.	36-60 months	HP/Customer	Full payout
HP State & Local Government Plan	Special financing for state & local government customers.	12-60 months	HP/Customer	Full payout
HP Federal Lease to Ownership	Special financing for U.S. government customers.	12-36 months <sup>2</sup>	Customer	Full payout
HP Federal Rental Plan	Provides maximum flexibility for U.S. government customers.	6 & 12 months <sup>3</sup>	HP	65% payment credit

<sup>1</sup> Sixty-five percent of each payment may be credited towards end-of-term purchase, up to a total of 80% of the amount financed.

<sup>2</sup> 12-36 month terms for non-GSA customers; 36 month term for GSA customers.

<sup>3</sup> 6-month plan for HP instruments and analytical products, when ordered by Federal Government-direct customers, only.



### Communicating With HP

Hewlett-Packard is committed to providing convenient local support and the best possible attention to customer needs on a worldwide basis. There are more than 475 HP sales and support offices and distributorships in 103 countries. A listing of these offices starts on page 737.

### Product information

Your entry point to the resources of Hewlett-Packard is through the HP office nearest you. Our sales representatives and order support specialists are well-equipped to provide you with pre-sale assistance in product selection, as well as related business information such as current product availability and price delivered to your location. You can also call our Customer Information Centers for the same information, or for the location of your nearest Hewlett-Packard office. Locations of these centers are included in the listing of offices that starts on page 737.

### Electronic data interchange

In addition, HP has established Electronic Data Interchange (EDI) links with many customers to allow more timely information regarding products and orders as well as provide a more efficient flow of purchase orders and invoices.

### Sales office network

Most HP sales offices are tied into a sophisticated intra-company communications system. This not only means prompt transmission of orders to any HP product responsible division, it also speeds the flow of regular messages among HP sales offices and factories. The objective, of course, is to provide the fastest possible response to your product interests.

### Pricing and Quotations

Prices in this catalog are U.S. list prices at the time of approval for printing. Hewlett-Packard reserves the right to change prices. The prices for an order are determined by the prices prevailing at the time the order is received. Therefore, the prices in this catalog are intended only as budgetary information.

To obtain destination prices, formal quotations, pro forma invoices, or other information you need before ordering, contact the Hewlett-Packard office, distributorship, or Customer Information Center serving your area. See page 737.

### Placing Your Order

Because many products or configurations are changed or improved during the year, we suggest that you always contact your nearest HP sales office for current product and pricing information prior to placing your order.

The HP representatives at the sales office nearest you will be pleased to provide assistance in selecting the HP equipment most appropriate to your needs, and to help you prepare your order.

The information in this catalog will, in many cases, be sufficient for you to decide to buy a particular HP product. In those instances, call the nearest HP office for information on the product's availability and price.

HP wants to be sure the product delivered to you is exactly the one you want. Therefore, when placing your order, please specify the product model, accessory, or part number, as well as the product name. Be as complete as possible in specifying exactly what you want, including standard options.

If you want special features or capabilities, such as different color or a non-standard voltage, ask your HP sales representative about availability and cost first. Then include special instructions and specification details with your order.

**Inside the USA:** Orders for end use inside the USA should be placed with your nearest U.S. sales office.

**Outside the USA:** Orders for end use outside the USA should be placed with an HP sales office or distributorship in the country of end use. More information on placing such orders is available from the HP headquarters offices listed on page 737.

### Terms of Sale

**Inside the USA:** Hewlett-Packard's standard terms for established customers in the USA are net 30 days from invoice date.

Leasing and extended financing are available. However, the financing costs are not included in any product prices in this catalog. Your nearby HP office will be pleased to discuss your requirements and work with you in setting up an appropriate program. Also see page 734.

**Outside the USA:** Please contact the nearest Hewlett-Packard sales office or an authorized HP subsidiary or distributor regarding terms for orders placed with them.

### U.S. Government Sales

For U.S. government sales, contact your nearest HP sales office. Many products in this catalog are covered on GSA federal supply schedule multi-award contracts. Contact your HP sales office for contract numbers.

### Product Changes

Although product information and illustrations in this catalog were current at the time it was approved for printing, Hewlett-Packard, in a continuing effort to offer excellent products at a fair value, reserves the right to change specifications, designs, and models without notice.

### Shipping

**Inside the USA:** All prices include HP standard transportation and routing to any U.S. destination. If a different shipping method is needed, we will gladly ship to satisfy your requirements. Custom shipments are typically sent freight collect.

**Outside the USA:** Shipments to destinations outside the USA are made by either surface or air, as requested. Contact your HP sales office for details.

# OPERATING ENVIRONMENTS & WARRANTY

## Operating Environments

Hewlett-Packard provides solutions to customer needs through products that must operate in the expected environmental conditions. In an attempt to meet customer needs effectively, all new hardware designs are tested to internal HP standards on operating environments before they are released for sale. These internal HP standards are derived from our experience with existing environments at customer installations and from other well-known standards, such as IEC, ISO, ANSI, and MILITARY standards. These internal HP standards provide guidance to all divisions producing new hardware products and systems. The classification codes, used to identify expected environments where HP products or systems may be used, are as follows:

- A1 - Rugged Environment
- A2 - Outdoor Environment (Portable)
- B1 - Portable General Purpose Environment
- B2 - General Purpose Environment
- C1 - Controlled Office Environment
- C2 - Controlled Computer Room Environment

The classes range from the severe environments found in heavy industrial areas unsuitable for operating personnel (Class A1) to the controlled environments found in dedicated computer rooms (Class C2). Most HP hardware products are designed to meet Class B2, applying test limits commonly found in general purpose applications of light industrial and commercial facilities.

Several parameters of the operating environment are evaluated during the design process. The major ones are as follows:

- Operating temperature
- Storage temperature
- Humidity
- Altitude
- Shock
- Vibration
- Power line variation (frequency and voltage)
- Power line surge
- Power line sag and dropout
- Power line distortion susceptibility (THD)
- Electromagnetic interference (radiated and conducted)
- Magnetic interference
- Magnetic susceptibility
- Radiated susceptibility
- Electrostatic discharge
- Acoustics

Although the details of these internal HP standards are the property of HP and are treated as proprietary material, information on the classes and the test limits appropriate for each class is available for those considering the use of HP equipment at their own facility. To obtain this information contact your HP sales representative. If you are considering a specific product, ask your sales representative what environmental class it was designed to (A1,A2,B1, B2,C1,C2) and the limits it met for the environmental parameter of concern. The information you receive must not be construed as an implied warranty because the classification codes are used for guiding the design of new products and not for evaluation of production units. Only those specific parameters identified in the technical data sheet (specifications) for the model number of interest will be warranted by Hewlett-Packard according to the terms of the published warranty information.

## Support Life

Hewlett-Packard offers support services for all products for at least 5 years beyond the end of production. On most test and measurement equipment, support services are available for at least 10 years.

## Warranty

As an expression of confidence that our products will continue to meet the high standards of reliability and performance that our customers expect, Hewlett-Packard products carry the following warranty:

HP hardware products are warranted against defects in materials and workmanship. If HP receives notice of such defects during the warranty period, HP shall, at its option, either repair or replace hardware products which prove to be defective.

HP software and firmware products which are designated by HP for use with a hardware product, when properly installed on that hardware product, are warranted not to fail to execute their programming instructions due to defects in materials and workmanship. If HP receives notice of such defects during the warranty period, HP shall repair or replace software media and firmware which do not execute their programming instructions due to such defects. HP does not warrant that the operation of the software, firmware or hardware shall be uninterrupted or error free.

If HP is unable, within a reasonable time, to repair or replace any product to a condition as warranted, Buyer shall be entitled to a refund of the purchase price upon return of the product to HP.

a. **SUPPLEMENTAL STATEMENT:** Supplemental statements setting forth the duration and implementation of warranty and installation are available for most product types. These statements, if applicable to purchased products, are attached hereto and incorporated herein.

b. **DURATION AND COMMENCEMENT OF WARRANTY PERIOD:** The warranty period for each product is specified in the supplemental statement of warranty and installation attached hereto and incorporated herein. The warranty period begins either on the date of shipment or, where the purchase price includes installation by HP, on the date of installation. If Buyer schedules or delays installation more than thirty (30) days after delivery, the warranty period begins on the thirty-first (31st) day from the date of shipment.

c. **PLACE OF PERFORMANCE:** Within HP service travel areas, warranty and installation services for products installed by HP and certain other products designated by HP will be performed at Buyer's facility at no charge. Outside HP's service travel areas, warranty and installation services will be performed at Buyer's facility only upon HP's prior agreement and Buyer shall pay HP's round trip travel expenses and applicable additional expenses for such services.

On-site warranty services are provided only at the initial installation point. If products eligible for on-site warranty and installation services are moved from the initial installation point, the warranty will remain in effect only if Buyer purchases additional inspection or installation services at the new site.

Installation and on-site warranty services are available outside the country of initial purchase only if Buyer pays HP international prices. If Buyer transports a product from the country of initial purchase without having paid HP international prices, any remaining warranty covers just parts and labor and applies only if the product is returned to the country of initial purchase. Warranties requiring return to HP are limited to the country of purchase unless the product is portable (battery powered) or the customer paid HP international prices.

For product warranties requiring return to HP, products must be returned to a service facility designated by HP. Buyer shall prepay shipping charges (and shall pay all duties and taxes) for products returned to HP for warranty service. Except for products returned to Buyer from another country, HP shall pay for return of products to Buyer.

d. **LIMITATION OF WARRANTY:** The foregoing warranty shall not apply to defects resulting from:

1. Improper or inadequate maintenance by Buyer;
2. Buyer-supplied software or interfacing;
3. Unauthorized modification or misuse;
4. Operation outside of the environmental specifications of the product; or
5. Improper site preparation and maintenance.

**THE WARRANTY SET FORTH ABOVE IS EXCLUSIVE AND NO OTHER WARRANTY, WHETHER WRITTEN OR ORAL, IS EXPRESSED OR IMPLIED. HP SPECIFICALLY DISCLAIMS THE IMPLIED WARRANTIES OF MERCHANTABILITY AND FITNESS FOR A PARTICULAR PURPOSE.**

## EXCLUSIVE REMEDIES

The remedies provided herein are Buyer's sole and exclusive remedies. In no event shall HP be liable for direct, indirect, special, incidental or consequential damages (including loss of profits) whether based on contract, tort, or any other legal theory.



**Please send directory corrections to:**

Test & Measurement Catalog, 54-AF  
Hewlett-Packard Company  
5301 Stevens Creek Blvd.  
P.O. Box 58059  
Santa Clara, CA 95052-8059  
Tel: (408) 553-7271  
Fax: (408) 983-1006

**HEADQUARTERS OFFICES**

If no sales office is listed for your country or area, please contact one of these headquarters offices.

**AUSTRALIA/  
NEW ZEALAND**

Hewlett-Packard Ltd.  
31 - 41 Joseph St.  
**BLACKBURN**, Victoria 3130  
Tel: (61/3) 895-2895  
Fax: (61/3) 898-7831  
Telex: 31024MELB

**FAR EAST**

Hewlett-Packard Asia Ltd.  
22/F Bond Centre, West Tower  
89 Queensway, Central  
G.P.O. Box 863

**HONG KONG**

Tel: (852/5) 848-7777  
Fax: (852/5) 868-4997  
Telex: 76793 HPA HX  
Cable: HPASIAL TD

**JAPAN**

Yokogawa-Hewlett-Packard Ltd.  
3-29-21, Takaido-Higashi  
Suginami-Ku, **TOKYO** 168  
Tel: (81/3) 331-6111  
Fax: (81/3) 335-1478

**UNITED KINGDOM**

Hewlett-Packard Ltd.  
Nine Mile Ride  
**WOKINGHAM**  
Berkshire, RG11 3LL  
Tel: (44/34) 477-3100  
Fax: (44/34) 476-3526

**EASTERN EUROPE**

Hewlett-Packard GmbH  
Liebigasse 1  
P.O. Box 72  
1222 **VIENNA**, Austria  
Tel: (43/222) 2500-0  
Fax: (43/222) 2500-444  
Telex: 134 425

**NORTHERN EUROPE**

Hewlett-Packard S.A.  
Van der Hooplaan 241  
P.O. Box 999  
1185 LN **AMSTELVEEN**  
The Netherlands  
Tel: (31/20) 547 9999  
Fax: (31/20) 43 1120  
Telex: 18919 hpner nl

**SOUTH EAST EUROPE**

Hewlett-Packard GmbH  
Liebigasse 1  
P.O. Box 72  
1222 **VIENNA**, Austria  
Tel: (43/222) 2500-0  
Fax: (43/222) 2500-444  
Telex: 134 425 hpner nl

**EUROPEAN MULTICOUNTRY  
REGION**

Hewlett-Packard S.A.  
150, Route du Nant d'Avril  
1217 Meyrin 2  
**GENEVA**, Switzerland  
Tel: (41/22) 780 8111  
Fax: (41/22) 780 8609

**MIDDLE EAST  
AND AFRICA**

Hewlett-Packard S.A.  
International Sales Branch  
Middle East/Africa  
7, rue du Bois-du-Lan  
P.O. Box 364  
1217 Meyrin 1  
**GENEVA**, Switzerland  
Tel: (41/22) 780 7111  
Fax: (41/22) 783 7535

**CANADA**

Hewlett-Packard (Canada) Ltd.  
6877 Goreway Drive  
**MISSISSAUGA**, Ontario L4V 1M8  
Tel: (416) 678-9430  
Fax: (416) 673-7253

**LATIN AMERICA**

Hewlett-Packard Company  
Latin American Region, Miami Office  
7208 N.W. 31st St.  
**MIAMI**, FL 33122  
United States  
(305) 590-1400/1401  
Fax: (305) 590-1427/1428  
Telex: 441603HPMIAMI

**UNITED STATES OF  
AMERICA**

Customer Information Center  
(800) 752-0900  
6:00 AM to 5:00 PM Pacific Time

**U.S. GOVERNMENT  
SPECIALISTS**

**ARMY**  
Tel: (201) 562-6107  
Fax: (201) 562-6246  
**NAVY**  
Tel: (301) 258-2311  
Fax: (301) 948-5986  
**AIR FORCE**  
Tel: (512) 491-1223  
Fax: (512) 491-1299  
**FEDERAL PROGRAMS**  
Tel: (301) 362-7702  
Fax: (301) 362-7650

**EASTERN USA**

Hewlett-Packard Co.  
4 Chocho Cherry Road  
**ROCKVILLE**, MD 20850  
Tel: (301) 670-4300

**MIDWESTERN USA**

Hewlett-Packard Co.  
5201 Tollview Drive  
**ROLLING MEADOWS**, IL 60008  
Tel: (312) 255-9800

**SOUTHERN USA**

Hewlett-Packard Co.  
2015 South Park Place  
**ATLANTA**, GA 30339  
Tel: (404) 955-1500

**WESTERN USA**

Hewlett-Packard Co.  
5161 Lankershim Blvd.  
**NORTH HOLLYWOOD**, CA 91601  
Tel: (818) 505-5600

**ALGERIA**

Hewlett-Packard Trading S.A.  
Bureau de Liaison  
71, Lot. Benachour Abdelkader  
**CHERAGA**  
Tel: (213) 281 0287  
Fax: (213) 281 0287  
Telex: 0408 63161

**ARGENTINA**

Hewlett-Packard Argentina S.A.  
Montaneses 2140/50  
1428 **BUENOS AIRES**  
Tel: (54/1) 781 4069  
(54/1) 781-4090

**AUSTRALIA**

**Brisbane, Queensland  
Office**

Hewlett-Packard Australia Ltd.  
10 Payne Road  
**THE GAP**, Queensland 4061  
Tel: (61/7) 300-4133  
Fax: (61/7) 300-5592  
Telex: 42133  
Cable: HEWPARD Brisbane

**Canberra, Australia  
Capital Territory  
Office**

Hewlett-Packard Australia Ltd.  
Thynne Street, Fern Hill Park  
**BRUCE**, A.C.T. 2617  
Tel: (61/8) 251-6999  
Fax: (61/8) 251-6948  
Telex: 62650  
Cable: HEWPARD Canberra

**Melbourne, Victoria  
Office**

Hewlett-Packard Australia Ltd.  
126-142 Trennery Crescent  
Abbotsford, VIC 3067  
Tel: (61/3) 895-2895  
Fax: (61/3) 898-7831  
Cable: HEWPARD Melbourne

**Parkside, South  
Australia Office**

Hewlett-Packard Australia Ltd.  
153 Greenhill Road  
**PARKSIDE**, S.A. 5063  
Tel: (61/8) 272-5911  
Fax: (61/8) 373-1398

**Perth,  
Western Australia  
Office**

Hewlett-Packard Australia Ltd.  
Herdsman Business Park  
Cnr. Hasler & Gould St.  
**OSBORNE PARK**, W.A. 6017  
Tel: (61/9) 441-8000  
Fax: (61/9) 242-1682  
Cable: HEWPARD Perth

**Sydney, New South  
Wales Office**

Hewlett-Packard Australia Ltd.  
17-23 Talavera Road  
P.O. Box 308  
**NORTH RYDE**, N.S.W. 2113  
Tel: (61/2) 888-4444  
Fax: (61/2) 888-9072  
Cable: HEWPARD Sydney

**AUSTRIA**

Hewlett-Packard GmbH  
Verkaufsbüro Graz  
Grottenhofstrasse 94  
8052 **GRAZ**  
Tel: (43/316) 28 3066  
Fax: (43/316) 28 1756  
Telex: 312375

**Hewlett-Packard GmbH**

Liebigasse 1  
P.O. Box 72  
1222 **VIENNA**  
Tel: (43/222) 2500-0  
Fax: (43/222) 2500 - 444

**BAHRAIN**

Wael Pharmacy and Drugstore  
P.O. Box 648  
**MANAMA**  
Tel: (973) 25 61 23  
Fax: (973) 23 36 38  
Telex: 8550 WAEL BN



# SALES OFFICES

Arranged alphabetically by country (cont'd)

## BARBADOS

Computers & Controls (Barbados) Ltd.  
Suite 5, 1st Floor  
Wildey Shopping Plaza  
**ST. MICHAEL**  
Tel: (809) 429-4103  
Fax: (809) 429-4103

## BELGIUM

Hewlett-Packard Belgium S.A./N.V.  
Blvd de la Woluwe, 100  
Woluwedal  
1200 **BRUSSELS**  
Tel: (32/2) 761 31 11  
Fax: (32/2) 763 06 13

## BENIN

Engineering Business Concept (E.B.C.)  
21, Route du Canal  
Zone 3  
04 B.P. 1357  
**ABIDJAN**  
Ivory Coast  
Tel: (225) 21 50 24  
Fax: (225) 35 37 90

## BERMUDA

Applied Computer Technologies  
17 Reid St.  
**HAMILTON 5**  
Tel: (809) 295-1616  
Fax: (809) 292-7967  
Telex: 380 3589/ACT BA

## BOLIVIA

Siser Ltda. (Sistemas de  
Importacion y Servicios Ltda.)  
Gabriel Gozalvez 221  
Casilla 4084

## LA PAZ

Tel: (59 1/2) 340962/  
363365/343245  
Fax: (59 1/2) 359268

## BRAZIL

Edisa Informatica S.A.  
Alameda Rio Negro, 750-Alphaville  
06454-**BARUERI-SP**  
Tel: (55/11) 709-1444  
Fax: (55/11) 709-1244  
Telex: 1171351

## Edisa Informatica S.A.

Rua dos Andradas, 1001-10 andar  
90020-**PORTO ALEGRE-RS**  
Tel: (55/51) 225-7166  
Fax: (55/51) 225-4060  
Telex: 515663

## Edisa Informatica S.A.

Av. Eng. Abdias de Carvalho, 1111-5 andar  
50751-**RECIFE-PE**  
Tel: (55/81) 227-2722  
Fax: (55/81) 228-3793  
Telex: 812904

## Edisa Informatica S.A.

Praia de Botafogo, 228-4 andar  
22250-**RIO DE JANEIRO-RJ**  
Tel: (55/21) 552-0222  
Fax: (55/21) 551-1449  
Telex: 2121905

## BRUNEI

Komputer Wisman Sdn Bhd  
Room 1, 3rd Floor  
Jalan Tutong  
BS Begawan  
**BRUNEI DARUSSALEM**  
Tel: (673/2) 23918  
Telex: 0809 2447

## BURKINA FASSO

Engineering Business Concept (E.B.C.)  
21, Route du Canal  
04 B.P. 1357  
**ABIDJAN**  
Ivory Coast  
Tel: (225) 21 50 24  
Fax: (225) 35 37 90

## CANADA

### Alberta

Hewlett-Packard (Canada) Ltd.  
150 - 6th Avenue S.W.  
**CALGARY**, Alberta T2P 3Y7  
Tel: (403) 262-0777  
Fax: (403) 237-9309  
Hewlett-Packard (Canada) Ltd.  
11120-178th Street  
**EDMONTON**, Alberta T5S 1P2  
Tel: (403) 486-6666  
Fax: (403) 489-8764

### British Columbia

Hewlett-Packard (Canada) Ltd.  
10691 Shellbridge Way  
**RICHMOND**,  
British Columbia V6X 2W8  
Tel: (604) 270-2277  
Fax: (604) 270-0859

### Manitoba

Hewlett-Packard (Canada) Ltd.  
1825 Inkster Blvd.  
**WINNIPEG**, Manitoba R2X 1R3  
Tel: (204) 694-2777  
Fax: (204) 694-3901

### Nova Scotia

Hewlett-Packard (Canada) Ltd.  
201 Brownlow Avenue  
**DARTMOUTH**, Nova Scotia B3B 1W2  
Tel: (902) 468-4725  
Fax: (902) 468-2817

## Hewlett-Packard (Canada) Ltd.

475 Hood Rd., Unit #2  
**MARKHAM**, Ontario L3R 8H1  
Tel: (416) 479-1770  
Fax: (416) 479-3105

### Ontario

Hewlett-Packard (Canada) Ltd.  
552 Newbold Street  
**LONDON**, Ontario N6E 2S5  
Tel: (519) 686-9181  
Fax: (519) 686-9145

## Hewlett-Packard (Canada) Ltd.

6877 Goreway Drive  
**MISSISSAUGA**, Ontario L4V 1M8  
Tel: (416) 678-9430  
Fax: (416) 678-9421

Hewlett-Packard (Canada) Ltd.  
2670 Queensview Dr.  
**OTTAWA**, Ontario K2B 8K1  
Tel: (613) 820-6483  
Fax: (613) 820-0377

## Quebec

Hewlett-Packard (Canada) Ltd.  
17500 Trans Canada Highway  
South Service Road  
**KIRKLAND**, Quebec H9J 2X8  
Tel: (514) 697-4232  
Fax: (514) 697-6941

## Saskatchewan

Hewlett-Packard (Canada) Ltd.  
#1, 2175 Airport Rd.  
**SASKATOON**, Saskatchewan S7L 7E1  
Tel: (306) 242-3702

## CHILE

Avanzados Sistemas de  
Conocimientos S. A. (ASC)  
Austria 2041  
**SANTIAGO**  
Tel: (56/2) 223-5946/6148  
Fax: (56/2) 223-1912

## CHINA, PEOPLE'S REPUBLIC OF

China Hewlett-Packard Co., Ltd.  
38 Bei San Huan Xi Road  
Shuang Yu Shu, Hai Dian District  
P.O. Box 9610

### BEIJING

Tel: (86/1) 256-6888  
Fax: (86/1) 256-3207

## China Hewlett-Packard Co., Ltd.

28/F Shanghai Union Building  
100 Yan An Dong Road  
**SHANGHAI** 200002  
Tel: (86/21) 320-3240  
Fax: (86/21) 320-2149

## COLOMBIA

Carbajal S.A.  
Calle 29 Norte No. 6 A 40  
Apartado Aereo 46  
**CALI**  
Tel: (57/23) 675 011  
Fax: (57/23) 688 466

## COSTA RICA

I.S. de Costa Rica S.A.  
Calle 25, Avs. 6 y 8 No.648  
**SAN JOSE**  
Tel: (50/6) 33 3722  
Fax: (50/6) 55 3528

## CYPRUS

Telerexa Ltd.  
P.O. Box 1152  
Valentine House  
8 Stassandrou St.  
**NICOSIA**  
Tel: (357/2) 445 628  
Telex: 0605 5845 tlrx cy

## DENMARK

Hewlett-Packard A/S  
Birkerød Kongevejen 25  
3460 **BIRKERØD**  
Tel: (45/42) 81 66 40  
Fax: (45/42) 81 58 10

## Hewlett-Packard A/S

Voldbjergvej 16  
8240 **RISSKOV**, Aarhus  
Tel: (45/06) 17 60 00  
Fax: (45/06) 17 60 58  
Telex: 37409 hpas dk

## DOMINICAN REPUBLIC

Esacom S.A.  
Edificio Mercantil del Caribe  
Ave. John F. Kennedy No. 11  
P.O. Box 1496  
**SANTO DOMINGO**  
Tel: (809) 567 3241  
Fax: (809) 566 9774  
Telex: ITT 346 0439

## ECUADOR

CYEDE Cia. Ltda.  
Avenida Eloy Alfaro 1749  
y Belgica  
Casilla 6423 CCI  
**QUITO**  
Tel: (593) 245-0075  
Fax: (593) 224-4223  
Telex: 39322548 CYEDE ED

## EGYPT

International Engineering Associates  
6 El Gamea Street  
**AGUZA/CAIRO**  
Tel: (20/2) 71 21 68  
Telex: 93830 IEA UN  
Cable: INTEGASSO

## EL SALVADOR

IPESA de El Salvador S.A.  
29 Avenida Norte 1223  
**SAN SALVADOR**  
Tel: (503) 266 858  
Telex: 301 20539 IPESA SAL

## FINLAND

Hewlett-Packard Oy  
Piispankalliontie 17  
02200 **ESPOO (Helsinki)**  
Tel: (358/0) 887 21  
Fax: (358/0) 887 22 77

## Hewlett-Packard Oy

Väinönkatu 9 C  
40100 **JYVÄSKYLÄ**  
Tel: (358/41) 21 85 11

## Hewlett-Packard Oy

Valtatie 57  
90500 **OULU**  
Tel: (358/81) 340 144  
Fax: (358/81) 340 145

**FRANCE****Aix-En-Provence**

Hewlett-Packard France  
ZI Mercure B  
Rue Berthelot  
13763 **LES MILLES** Cédex  
Tel: (33) 42 24 32 43  
Fax: (33) 42 59 48 72  
Telex: 410 770

**Bordeaux**

Hewlett-Packard France  
Domaine de Pélus  
5, avenue de Pythagore  
33700 **MERIGNAC**  
Tel: (33) 56 34 00 84  
Fax: (33) 56 34 80 84  
Telex: 550 105

**Brest**

Hewlett-Packard France  
ZAC Kergaradec  
8, rue Fernand Forest  
29239 **GOUESNOU**  
Tel: (33) 98 41 87 90  
Fax: (33) 98 41 74 77

**Grenoble**

Hewlett-Packard France  
57, chemin du Vieux Chêne  
ZIRST  
38240 **MEYLAN**  
Tel: (33) 76 90 38 40  
Fax: (33) 76 41 05 36

**Lille**

Hewlett-Packard France  
Parc d'activités des Prés  
1, rue Papin  
59658 **VILLENEUVE D'ASCO**  
Tel: (33) 20 47 78 78  
Fax: (33) 20 33 36 77  
Telex: 160 124

**Lyon**

Hewlett-Packard France  
Chemin des Mouilles  
BP 162  
69131 **ECULLY** Cédex  
Tel: (33) 72 29 32 93  
Fax: (33) 78 33 49 82  
Telex: 310 617

**Nice**

Hewlett-Packard France  
Les Cardoulines - Bât. 2  
Route des Dolines  
Sophia Antipolis  
06560 **VALBONNE**  
Tel: (33) 93 65 39 40  
Fax: (33) 93 65 31 34

**Orléans**

Hewlett-Packard France  
Parc Tertiaire Hétiopolis  
Route de Mic  
45380 **LA CHAPELLE ST MESMIN**  
Tel: (33) 38 43 94 56  
Fax: (33) 38 88 22 81  
Telex: 783 497

**Orsay**

Hewlett-Packard France  
Zone Industrielle de Courtaboeuf  
1, avenue du Canada  
91947 **LES ULIS** Cédex  
Tel: (33/1) 69 82 60 60  
Fax: (33/1) 69 82 60 61  
Telex: 600 048

**Rennes**

Hewlett-Packard France  
Parc d'activités de la Poterie  
Rue Louis Kerautret-Botmel  
35000 **RENNES**  
Tel: (33) 99 51 42 44  
Fax: (33) 99 32 29 19  
Telex: 740 912

**Rouen**

Hewlett-Packard France  
PAT Lavatine  
3, rue Jacques Monod  
BP 228  
76136 **MONT-ST-AIGNAN**  
Tel: (33) 35 59 19 20  
Fax: (33) 35 59 85 11  
Telex: 770 035

**Strasbourg**

Hewlett-Packard France  
4, rue de la Faisanderie  
Parc Club des Tanneries  
BP 40  
67381 **LINGOLSHEIM** Cédex  
Tel: (33) 88 76 15 00  
Fax: (33) 88 78 17 63  
Telex: 890 141

**Toulouse**

Hewlett-Packard France  
Innoparc  
BP 167 Voie n° 7  
31328 **LABEGE** Cédex  
Tel: (33) 61 39 11 40  
Fax: (33) 61 39 10 97  
Telex: 531 639

**GERMAN FEDERAL  
REPUBLIC****HEADQUARTERS**

Hewlett-Packard GmbH  
Herrenberger Strasse 130  
7030 **BÖBLINGEN**  
Tel: (49/7031) 14-0  
Fax: (49/7031) 14-2999

Hewlett-Packard GmbH  
Bad Homburg  
Hewlett-Packard-Strasse  
6380 **BAD HOMBURG**  
Tel: (49) 6172 16-0  
Fax: (49) 6172 16-1309  
Telex: 410 844 hpbhg

**Berlin**

Hewlett-Packard GmbH  
Lützowplatz 15  
1000 **BERLIN** 30  
Tel: (49/30) 2500 02-0  
Fax: (49/30) 2500 02-62  
Telex: 018 3405 hpbln d

**Böblingen**

Hewlett-Packard GmbH  
Schickardstrasse 2  
7030 **BÖBLINGEN**  
Tel: (49/7031) 645-0  
Fax: (49/7031) 645-429

**Bonn**

Hewlett-Packard GmbH  
Friedrich-Ebert-Allee 26  
5300 **BONN** 1  
Tel: (49/228) 23400-1  
Fax: (49/228) 235 315

**Dortmund**

Hewlett-Packard GmbH  
Schleefstrasse 28  
4600 **DORTMUND**-Aplerbeck  
Tel: (49/231) 45001-0  
Fax: (49/231) 45001-37  
Telex: 822858 hepdod

**Frankfurt**

Hewlett-Packard GmbH  
Reparaturzentrum Frankfurt  
Bernner Strasse 117  
6000 **FRANKFURT** 56  
Tel: (49/69) 5000 60  
Fax: (49/69) 5000 6-200  
Telex: 412 815 hpffm

**Hamburg**

Hewlett-Packard GmbH  
Kapstadtring 5  
2000 **HAMBURG** 60  
Tel: (49/40) 63804-0  
Fax: (49/40) 63804-327  
Telex: 2163032

**Hannover**

Hewlett-Packard GmbH  
Heidering 37-39  
3000 **HANNOVER** 61  
Tel: (49/511) 5706-0  
Fax: (49/511) 5706-126

**Mannheim**

Hewlett-Packard GmbH  
Rosslauer Weg 2-4  
6800 **MANNHEIM** 31  
Tel: (49/621) 7005-0  
Fax: (49/621) 7005-200  
Telex: 462105

**München (Munich)**

Hewlett-Packard GmbH  
Eschenstrasse 5  
8028 **TAUFKIRCHEN**  
Tel: (49/89) 61207-0  
Fax: (49/89) 61207-300  
Telex: 0524985 hpmch

**Nürnberg**

Hewlett-Packard GmbH  
Emmericher Strasse 13  
8500 **NÜRNBERG** 10  
Tel: (49/911) 5205-0  
Fax: (49/911) 5205-140  
Telex: 623860

**Ratingen**

Hewlett-Packard GmbH  
Berliner Strasse 111  
4030 **RATINGEN** 1  
Tel: (49/2102) 494-0  
Fax: (49/2102) 494-300  
Telex: 8589070

**Ulm**

Hewlett-Packard GmbH  
Messerschmittstrasse 7  
7910 **NEU ULM**  
Tel: (49/731) 7073-0  
Fax: (49/731) 7076-66  
Telex: 712816

**Waldbronn**

Hewlett-Packard GmbH  
Ermilis-Allee  
7517 **WALDBRONN** 2 (Karlsruhe)  
Tel: (49/7243) 602-0  
Fax: (49/7243) 602-512  
Telex: 7265743

**GHANA**

Engineering Business Concept (E.B.C.)  
21, Route du Canal  
Zone 3  
04 B.P. 1357  
**ABIDJAN**  
Ivory Coast  
Tel: (225) 31 50 24  
Fax: (225) 35 37 90

**GREAT BRITAIN  
See United Kingdom****GREECE**

Hewlett-Packard Hellas  
32, Kifissias Avenue  
15125 Amaroussion  
**ATHENS**  
Greece  
Tel: (30/1) 682 88 11  
Fax: (30/1) 683 29 78  
Telex: 216588 hpat gr

**GUATEMALA**

Ipsa de Guatemala  
Avenida Reforma 3-48, Zona 9  
**GUATEMALA CITY**  
Tel: (502) 231-7853  
Fax: (502) 231-6627  
Telex: 3055765 IPESA GU

**HONG KONG**

Hewlett-Packard Asia, Ltd.  
22/F, Bond Centre, West Tower  
89 Queensway Central  
**HONG KONG**  
Tel: (852/5) 848-7777  
Fax: (852/5) 868-4997  
Cable: HEWPACK HONG KONG

# SALES OFFICES

## Arranged alphabetically by country (cont'd)

### HUNGARY

Hewlett-Packard  
Accredite Office Hungary  
Radvány u. 7  
1118 **BUDAPEST**  
Tel: (36/1) 185 23 68  
Fax: (36/1) 165 10 85  
Telex: 861 227 632

### ICELAND

Hewlett-Packard Iceland  
Höfðabakka 9  
110 **REYKJAVIK**  
Tel: (354/1) 67-1000  
Fax: (354/1) 67-3031  
Telex: 37409

### INDIA

#### Bangalore

Hewlett-Packard India Pvt. Ltd.  
29 Cunningham Road  
**BANGALORE** 560 052  
Tel: (91/812) 261075  
Fax: (91/812) 261554

#### Bombay

Hewlett-Packard India Pvt. Ltd.  
Sahas  
414/2 Veer Savarkar Marg  
Prabhadevi  
**BOMBAY** 400 025  
Tel: (91/22) 4306155  
Fax: (91/22) 4307078

#### Calcutta

Hewlett-Packard India Pvt. Ltd.  
DBS Executive Centre  
8 Acharya J. C. Bose Road  
**CALCUTTA** 700 017  
Tel: (91/33) 444990  
Fax: (91/33) 444614

#### Hyderabad

Hewlett-Packard India Pvt. Ltd.  
9-5-13 Taramandal Complex  
9th Floor  
Saifabad  
**HYDERABAD** 500 004  
Tel: (91/842) 231756  
Fax: (91/842) 8313444

#### New Delhi

Hewlett-Packard India Pvt. Ltd.  
B-8 Jangpura  
Mathura Road  
**NEW DELHI** 110 014  
Tel: (91/11) 690329  
Fax: (91/11) 353315

### INDONESIA

BERCA Indonesia P.T.  
Wisma Dharmala Sakti  
10/F, J1, Jendral Sudirman K.av 32  
P.O. Box 41/JKPD  
**JAKARTA** 10001  
Tel: (62/21) 578-0005  
Fax: (62/21) 570-1287  
Telex: 62065 BERCAMIA

### IRAQ

Hewlett-Packard Trading S.A.  
(Service Operation)  
Al Mansoor City 609/10/7  
**BAGHDAD**  
Tel: (964/1) 541 49 73  
Fax: (964/1) 541 49 73  
Telex: 212455 hepairagik

### IRELAND

Hewlett-Packard Ireland Ltd.  
Temple House, Temple Road  
Blackrock, Co. **DUBLIN**  
Tel: (353/1) 883399  
Fax: (353/1) 883742  
Telex: 30439

### ISRAEL

Computation and Measurement  
Systems (CMS) Ltd.  
11, Hashlosha Street  
**TEL-AVIV** 67060  
Tel: (972) 3 5380-333  
Fax: (972) 3 5375-055  
Telex: 371234 HPCMS

### ITALY

#### Anzola Emilia-Bologna

Hewlett-Packard Italiana S.p.A.  
Via Emilia, 51/C  
40011 **ANZOLA EMILIA-BOLOGNA**  
Tel: (39/51) 73 10 61  
Fax: (39/51) 73 48 30  
Telex: 51 16 30

#### Bari

Hewlett-Packard Italiana S.p.A.  
Via Vitantonio di Cagno, 34  
70124 **BARI**  
Tel: (39/80) 41 07 44  
Fax: (39/80) 41 78 51

#### Catania

Hewlett-Packard Italiana S.p.A.  
Via Principe Nicola, 43 G/C  
95126 **CATANIA**  
Tel: (39/95) 37 10 87  
Fax: (39/95) 38 85 69

#### Corsico

Hewlett-Packard Italiana S.p.A.  
Via G. di Vittorio, 10  
20094 **CORSICO** (MI)  
Tel: (39/2) 440 83 51  
Fax: (39/2) 440 95 64  
Telex: 440 9564

#### Firenze

Hewlett-Packard Italiana S.p.A.  
Via Sacco e Vanzetti, 1  
50145 **FIRENZE**  
Tel: (39/55) 31 85 53  
Fax: (39/55) 37 39 65

#### Genova

Hewlett-Packard Italiana S.p.A.  
Viale Brigata Bisagno, 2  
16129 **GENOVA**  
Tel: (39/10) 54 11 41  
Fax: (39/10) 59 17 33  
Telex: 28 52 38

### Limito

Hewlett-Packard Italiana S.p.A.  
Via Nuova Rivoltana, 95  
20090 **LIMITO** (MI)  
Tel: (39/2) 757 61  
Fax: (39/2) 757 6230  
Telex: 32 31 16

### Napoli

Hewlett-Packard Italiana S.p.A.  
Via Orazio, 16  
80122 **NAPOLI**  
Tel: (39/81) 761 14 44  
Fax: (39/81) 68 01 64  
Telex: 71 06 98

### Padova

Hewlett-Packard Italiana S.p.A.  
Via Pellizzo, 15  
35128 **PADOVA**  
Tel: (39/49) 807 01 66  
Fax: (39/49) 77 30 97  
Telex: 43 03 15

### Roma-Eur

Hewlett-Packard Italiana S.p.A.  
Via del Tintoretto, 200  
00142 **ROMA-EUR**  
Tel: (39/6) 5 48 31  
Fax: (39/6) 540 87 10  
Telex: 62 65 24

### Torino

Hewlett-Packard Italiana S.p.A.  
C.so Svizzera, 185  
10149 **TORINO**  
Tel: (39/11) 74 40 44  
Fax: (39/11) 771 08 15  
Telex: 22 10 79

### IVORY COAST

Engineering Business Concept (E.B.C.)  
Angle Avenue J. Anoma et Bd.  
République  
08 B.P. 323 **ABIDJAN** 08  
Tel: (225) 32 50 24/41 48 70  
Fax: (225) 35 37 90

### JAPAN

#### Akita

Yokogawa-Hewlett-Packard Ltd.  
Nihonseimei Akita Chudori Bldg.  
4-2-7 Nakadori  
**AKITA** 010  
Tel: (81/188) 36-5021  
Fax: (81/188) 36-5099

#### Atsugi

Yokogawa-Hewlett-Packard Ltd.  
Keno Kikaku Kogyo No. 2 Bldg.  
9-32 Tamuracho  
**ATSUGI** 243  
Tel: (81/462) 25-0031  
Fax: (81/462) 25-0064

#### Chiba

Yokogawa-Hewlett-Packard Ltd.  
Fujimoto Daiichi Seimei Bldg.  
3-3-1 Chuo  
**CHIBA** 280  
Tel: (81/472) 25-7701  
Fax: (81/472) 21-0382

### Fukuoka

Yokogawa-Hewlett-Packard Ltd.  
Daisan Hakata-Kaisei Bldg.  
1-3-6 Hakataekiminami Hakata-ku  
**FUKUOKA** 812  
Tel: (81/92) 472-8731  
Fax: (81/92) 473-4745

### Hiroshima

Yokogawa-Hewlett-Packard Ltd.  
Yasuda-seimei Hiroshima Bldg.  
6-11 Hondori Naka-ku  
**HIROSHIMA** 730  
Tel: (81/82) 241-0611  
Fax: (81/82) 241-0619

### Kobe

Yokogawa-Hewlett-Packard Ltd.  
Towa Building  
2-2-3 Kaigandori, Chuo-ku  
**KOBE** 650  
Tel: (81/78) 392-4791  
Fax: (81/78) 392-4839

### Koriyama

Yokogawa-Hewlett-Packard Ltd.  
Nihon-Dantai-seimei Bldg.  
21-10 Toramaru-machi  
**KORIYAMA** 963  
Tel: (81/249) 39-7111  
Fax: (81/249) 39-7234

### Kumagaya

Yokogawa-Hewlett-Packard Ltd.  
Kumagaya Asahi 82 Bldg.  
3-4 Tsukuba  
**KUMAGAYA** 360  
Tel: (81/485) 24-6563  
Fax: (81/485) 24-9050

### Kyoto

Yokogawa-Hewlett-Packard Ltd.  
Shin-Kyoto Center Bldg.  
614 Higashi-Shokoji-cho  
Karasuma-nishi-iru, Shiokoji-dori  
Shimogyo-ku  
**KYOTO** 600  
Tel: (81/75) 343-0921  
Fax: (81/75) 343-4356

### Mito

Yokogawa-Hewlett-Packard Ltd.  
Mito Mitsui Bldg.  
1-4-73 Sannomaru  
**MITO** 310  
Tel: (81/292) 25-7470  
Fax: (81/292) 31-6589

### Miyazaki

Yokogawa-Hewlett-Packard Ltd.  
Nomura Shoken Bldg.  
4-1-2 Tachibana-dori  
Miyazaki-C.  
**MIYAZAKI** 880  
Tel: (81/985) 23-7280  
Fax: (81/985) 23-7864

### Nagano

Yokogawa-Hewlett-Packard Ltd.  
Nagano-Tolyo-kaijo Bldg.  
1081, Minamiagatamachi  
**NAGANO** 380  
Tel: (81/262) 24-8012  
Fax: (81/262) 24-8016

**Nagoya**

Yokogawa-Hewlett-Packard Ltd.  
Nagoya Kokusai Center Bldg.  
1-47-1 Nakono, Nakamura-ku  
**NAGOYA 450**  
Tel: (81/52) 571-2262  
Fax: (81/52) 565-0896

**Nara**

Yokogawa-Hewlett-Packard Ltd.  
Nissei Nara Ekimae Bldg.  
1-1-15 Omiya-cho  
**NARA 630**  
Tel: (81/742) 22-8235  
Fax: (81/742) 22-8219

**Oomiya**

Yokogawa-Hewlett-Packard Ltd.  
Saikyoren Bldg.  
1-2 Dotemachi  
**OOMIYA 330**  
Tel: (81/48) 645-8031  
Fax: (81/48) 645-8001

**Osaka**

Yokogawa-Hewlett-Packard Ltd.  
Chuo Bldg.  
5-4-20 Nishinakajima  
Yodogawa-ku  
**OSAKA 532**  
Tel: (81/6) 304-6021  
Fax: (81/6) 304-0216

**Sapporo**

Yokogawa-Hewlett-Packard Ltd.  
Sumitomo-seimei Sapporo Chu Bldg.  
1-1-14 Nanjo-higashi Chuo-ku  
**SAPPORO 060**  
Tel: (81/11) 251-1011  
Fax: (81/11) 222-3239

**Sendai**

Yokogawa-Hewlett-Packard Ltd.  
Yamaguchi Bldg.  
1-1-31 Ichibancho Aoba-ku  
**SENDAI 980**  
Tel: (81/22) 225-1011  
Fax: (81/22) 225-1616

**Suwa-gun**

Yokogawa-Hewlett-Packard Ltd.  
Daimon Bldg.  
139-1 Yaginishi Shimosuwa-cho  
**SUWA-GUN 393**  
Tel: (81/266) 28-8851  
Fax: (81/266) 28-8873

**Tokyo**

Yokogawa-Hewlett-Packard Ltd.  
Shinjuku Daiichi-seimei Bldg.  
2-7-1 Nishi-shinjuku  
Shinjuku-ku  
**TOKYO 160**  
Tel: (81/3) 342-2734  
Fax: (81/3) 348-7969

Yokogawa-Hewlett-Packard Ltd.  
9-1 Takakura-cho  
Hachioji-shi  
**TOKYO 192**  
Tel: (81/426) 42-1231  
Fax: (81/426) 45-2631

Yokogawa-Hewlett-Packard Ltd.  
Tokyo-Nissan Bldg.  
1-6-34 Konan, Minato-ku  
**TOKYO, 108**  
Tel: (81/3) 458-5411  
Fax: (81/3) 458-5400

Yokogawa-Hewlett-Packard Ltd.  
3-29-21 Takaide-higashi  
Suginami-ku  
**TOKYO 168**  
Tel: (81/3) 331-6111  
Telex: 232 2024 YHPTOK

Yokogawa-Hewlett-Packard Ltd.  
Tokyu Sakuragaokacho Bldg.  
31-2 Sakuragaoka Shibuya-ku  
**TOKYO 150**  
Tel: (81/3) 780-5511  
Fax: (81/3) 780-5510

**Toyota**

Yokogawa-Hewlett-Packard Ltd.  
Toyota-Tokyo-Kaijo Bldg.  
1-179 Miyuki-honmachi  
**TOYOTA 473**  
Tel: (81/565) 27-5611  
Fax: (81/565) 27-5400

**Tsukuba**

Yokogawa-Hewlett-Packard Ltd.  
Issei Bldg.  
2-3-17 Takezono  
**TSUKUBA 305**  
Tel: (81/298) 51-5141  
Fax: (81/298) 51-5381

**Utsunomiya**

Yokogawa-Hewlett-Packard Ltd.  
Chiyodaseimei-Utsunomiya Bldg.  
2-3-1 Odori  
**UTSUNOMIYA 320**  
Tel: (81/286) 33-1153  
Fax: (81/286) 33-1175

**Yokohama**

Yokogawa-Hewlett-Packard Ltd.  
No. 2 Yasuda Bldg.  
2-32-12 Tsuruyacho  
Kanagawa-ku  
**YOKOHAMA-SHI KANAGAWA**  
Tel: (81/45) 313-1352  
Fax: (81/45) 312-1846

**JORDAN**

Scientific & Medical Supplies Co.  
P.O. Box 1387  
**AMMAN**  
Tel: (962/6) 62 49 07  
Fax: (962/6) 62 82 58  
Telex: 0493 21456 sabco jo

**KENYA**

ADCOM Ltd., Inc., Kenya  
P.O. Box 30070  
**NAIROBI**  
Tel: (254/2) 33 1955  
Telex: 22639

**KOREA**

Samsung Hewlett-Packard Co. Ltd.  
Dongbang Building, 12-16/F  
36-1 Yeoeuido-dong  
Youngdeungpo-Ku  
**SEOUL, 150**  
Tel: (82/2) 769-0114  
Fax: (82/2) 784-7084  
Telex: SAM HP K 25166

Samsung Hewlett-Packard Co. Ltd.  
13/F Taegu Bank Bldg.  
118, 2-Ka  
Suseong-Dong  
Suseong-Ku  
**TAEGU**  
Tel: (82/53) 754-2666  
Fax: (82/53) 752-4696

Samsung Hewlett-Packard Co. Ltd.  
8/F, Daehankyoyuk Insurance Bldg.  
382-1 Sun Hwa-Dong  
Chung-Gu  
**TEEJON 301-050**  
Tel: (82/42) 256-6725  
Fax: (82/42) 256-6727

**KUWAIT**

Al-Khaldiya Trading & Contracting  
P.O. Box 830  
**SAFAT 13009**  
Tel: (965) 242 49 10, 241 17 26  
Fax: (965) 245 20 67  
Telex: 22481 AREEG KT  
Cable: VISCOUNT

**LEBANON**

Computer Information Systems S.A.L.  
Chammas Building  
P.O. Box 11-6274  
**DORA-BEIRUT**  
Tel: (961/1) 89 31 13  
Fax: (961/1) 58 18 34  
Telex: 42309 chaxis le

**LUXEMBOURG**

Hewlett-Packard Belgium S.A./N.V.  
Blvd de la Woluwe, 100  
Woluwedal  
**1200 BRUSSELS**  
Tel: (32/2) 761-3111  
Fax: (32/2) 763-0613  
Telex: 23 494 palobe b

**MALAWI**

Field Consolidated (Private) Ltd.  
System Division  
Manhattan Court  
61 Second Street  
P.O. Box 3458  
**HARARE**  
Zimbabwe  
Tel: (263/4) 73 98 81  
Fax: (263/4) 70 20 08  
Telex: 0907 26241

**MALAYSIA**

Hewlett-Packard Sales (M) SDN BHD  
9/F, Chung Khaiw Bank Building  
Section 46, Jalan Raja Laut  
GPO Box 11119  
**50736 KUALA LUMPUR**  
Tel: (60/3) 298-6555  
Fax: (60/3) 291-5495

Hewlett-Packard Sales (M) SDN BHD  
6/F, Wisma Penang Garden  
42, Jalan Sultan Ahmad Shah  
10050 **PENANG**  
Tel: (60/4) 376-532  
Fax: (60/4) 371-027

**MEXICO**

Hewlett-Packard de Mexico,  
S.A. de C.V.  
Rio Nio No. 4049 Desp. 12  
Fracc. Cordoba  
**CIUDAD JUAREZ, Mexico**  
Tel: (52/161) 3 15 62

Hewlett-Packard de Mexico,  
S.A. de C.V.  
Condominio Kadereyta  
Circuito del Mezon No. 186 Desp. 6  
Col. Del Prado  
**76030 QUERETARO, QRO**  
Tel: (52/4) 636-0271

Hewlett-Packard de Mexico,  
S.A. de C.V.  
Czda. del Valle  
409 Ote. 4th Piso  
Colonia del Valle  
Municipio de Garcia  
**66220 GARZA GARCIA, N.L.**  
Tel: (52/8) 378-4240  
Telex: 382410 HPMY

Hewlett-Packard de Mexico,  
S.A. de C.V.  
Monti Morelos No. 299  
Fraccionamiento Loma Bonita 45060  
**GUADALAJARA, Jalisco**  
Tel: (52/3) 631-4600  
Telex: 0684 186 ECOMEX

Hewlett-Packard de Mexico,  
S.A. de C.V.  
Monte Pelvoux No. 111  
Lomas de Chapultepec  
11000 **MEXICO, D.F.**  
Tel: (52/5) 202-0155  
Fax: (52/5) 540-4208

Hewlett-Packard de Mexico,  
S.A. de C.V.  
Blvd. Independencia  
No. 2000 Ote. Piso 3  
Col. Estrella  
27010 **TORREON, COA.**  
Tel: (52/1) 718-2201

**MOROCCO**

SICOTEL  
Complexe des Habous  
Tour C, avenue des Far  
**CASABLANCA 01**  
Tel: (212) 31 22 70  
Telex: 0407 27604

**NETHERLANDS**

Hewlett-Packard Nederland B.V.  
Startbaan 16  
P.O. Box 667  
**1180 NL AMSTELVEEN**  
Tel: (31/20) 547 69 11  
Fax: (31/20) 471 825  
Telex: 13 216 HEPANL



# SALES OFFICES

Arranged alphabetically by country (cont'd)

## NETHERLANDS (cont'd)

Hewlett-Packard Nederland B.V.  
Boschdijk 131  
P.O. Box 2342  
5612 HB **EINDHOVEN**  
Tel: (31/40) 32 69 11  
Fax: (31/40) 44 65 46  
Telex: 51484 hepae nl

## NEW ZEALAND

Hewlett-Packard (N.Z.) Ltd.  
5 Owens Road  
Epsom, **AUCKLAND 3**  
Tel: (64/9) 687-159  
Fax: (64/9) 600-507

Hewlett-Packard (N.Z.) Ltd.  
186-190 Willis Street  
**WELLINGTON 1**  
Tel: (64/4) 820-400  
Fax: (64/4) 843-380

## NIGER

Engineering Business Concept (E.B.C.)  
21, Route du Canal  
Zone 3  
04 B.P. 1357  
**ABIDJAN**  
Ivory Coast  
Tel: (225) 21 50 24  
Fax: (225) 35 37 90

## NIGERIA

Management Information Systems  
Co., Ltd.  
3, Gerrard Road, Ikoyi  
**LAGOS**  
Tel: (234/1) 68 08 87  
Fax: (234/1) 68 54 87  
Telex: 23582

## NORTHERN IRELAND

See United Kingdom

## NORWAY

Hewlett-Packard Norge A/S  
Oestermdalen 16-18  
P.O. Box 34  
N-1345 **OEËTERAAS**  
Tel: (47/2) 24-60 90  
Fax: (47/2) 24 66 96, 24 30 78  
Telex: 76621 HPNAS N

Hewlett-Packard Norge A/S  
Boemergt. 42  
Box 2470  
N-5037 **SOLHEIMSVIK**  
Tel: (47/5) 29 00 90  
Fax: (47/5) 29 10 72

## OMAN

Imtac LLC  
P.O. Box 9196  
**MINA AL FAHAL**  
Tel: (968) 70-77-27, 70-77-23  
Fax: (968) 79 66 39  
Telex: 0498 3865

## PAKISTAN

Mushko Electronics (PVT) Ltd.  
68-W Sama Plaza  
Blue Area, F-7  
**ISLAMABAD**  
Tel: (92/51) 814 492  
Fax: (92/51) 821 201  
Telex: 54001 Muski PK

Mushko Electronics (PVT) Ltd.  
Victoria Chambers  
Abdullah Haroon Road  
**KARACHI**  
Tel: (92/21) 524 131, 524 132  
Fax: (92/21) 512 298  
Telex: 2894 MUSKO PK

## PANAMA

Electronico Balboa, S.A.  
Calle Samuel Lewis, Ed. Alfa  
Apartado 4929  
**PANAMA CITY**  
Tel: (507) 636 613  
Fax: (507) 361 820  
Telex: 368 3483 ELECTRON PG

## PERU

Cia Electro Médica, S.A.  
Los Flamencos No. 145, Ofna. 301 & 302  
San Isidro, **LIMA 1**  
Tel: (51/14) 41-4325, 41-3703  
Fax: (51/14) 42-3572  
Telex: 39425257 PE PB SIS

## PHILIPPINES

The Online Advanced Systems Corp.  
2nd Floor, Electra House  
115-117 Esteban Street  
Legaspi Village, Makati  
Metro **MANILA**  
Tel: (63/2) 818-4394  
Fax: (63/2) 816-0590  
Telex: 63274 ONLINE PN

## PORTUGAL

Hewlett-Packard Portugal S.A.  
Torre de Santo Antonio  
Rua Gregorio Lopes, Lote 1732B  
Restelo  
1400 **LISBON**  
Tel: (351) 617 343/44/46  
Fax: (351) 617345  
Telex: 43126

Hewlett-Packard Portugal S.A.  
Edificio Tranquilidade  
Rua D. Manuel, 296  
4000 **PORTO**  
Tel: (351) 493 122  
Telex: 26054  
Fax: (351) 488 721

## PUERTO RICO

Hewlett-Packard Puerto Rico  
P.O. Box 4048  
**AGUADILLA 00605**  
Tel: (809) 890-6000

Hewlett-Packard Puerto Rico  
101 Munoz Rivera Avenue  
Esu. Calle Ochoa  
**HATO REY, 00918**  
Tel: (809) 754-7800

## QATAR

Qatar Datamation Systems  
P.O. Box 350  
**DOHA**  
Tel: (974) 44 19 16  
Fax: (974) 44 12 19  
Telex: 4833

## SAUDI ARABIA

Modern Electronic Establishment  
P.O. Box 281  
Thouqbah  
**AL-KHOBAR 31952**  
Tel: (966/3) 895-1760, 895-1764  
Telex: 0495 671 106 HPMEEK SJ  
Cable: ELECTA AL-KHOBAR

Modern Electronic Establishment  
P.O. Box 1228  
Redec Plaza, 6th Floor  
**JEDDAH 21431**  
Tel: (966/2) 644 96 28  
Fax: (966/2) 644 18 33  
Cable: ELECTA JEDDAH

Modern Electronic Establishment  
P.O. Box 22015  
**RIYADH 11495**  
Tel: (966/1) 476 30 30  
Fax: (966/1) 476 76 49  
Telex: 402049 MEERYD SJ

## SCOTLAND

See United Kingdom

## SINGAPORE

Hewlett-Packard Singapore Ltd.  
150 Beach Road  
#29-00 Gateway West  
PO Box 2, Bras Basah Post Office  
**SINGAPORE, 9118**  
Tel: (65) 291 9088  
Fax: (65) 292 7089  
Telex: RS 34209

## SOUTH AFRICA

Hi Performance Systems (Pty.) Ltd.  
P.O. Box 120, Howard Place  
**CAPE TOWN 7450**  
Tel: (27/21) 53-7954  
Fax: (27/21) 53-5119

Hi Performance Systems (Pty.) Ltd.  
Private Bag Wendywood  
**SANDTON 2144**  
Tel: (27/11) 802-5111  
Fax: (27/11) 802-6332

## SPAIN

**Barcelona**  
Hewlett-Packard Española S.A.  
Avda. Diagonal, 605  
08028 **BARCELONA**  
Tel: (34/3) 401 91 00  
Fax: (34/3) 230 84 68  
Telex: 52603 hpbee

## Bilbao

Hewlett-Packard Española, S.A.  
Avda. de Zugazarte, 8  
(Edificio El Abra 4)  
**48930 LAS ARENAS-GUECHO**  
Tel: (34/4) 464 32 55  
Fax: (34/4) 464 90 83  
Telex: 33032

## Madrid

Hewlett-Packard Española S.A.  
Crta. de la Coruña, km 16,500  
28230 Las Rozas  
**MADRID**  
Tel: (34/1) 637 00 11  
Fax: (34/1) 637 55 62  
Telex: 23515 HPE

## Sevilla

Hewlett-Packard Española S.A.  
c/Luis de Morales, S/N  
Edificio Forum  
41005 **SEVILLA**  
Tel: (34/5) 458 17 00  
Fax: (34/5) 457 57 20  
Telex: 72933

## Valencia

Hewlett-Packard Española S.A.  
Isabel La Católica, 8  
46004 **VALENCIA**  
Tel: (34/6) 351 59 44  
Telex: 63435  
Fax: (34/6) 351 49 06

## SWEDEN

### Göteborg

Hewlett-Packard Sverige AB  
Topasgatan 1A  
Box 266  
42123 **VÄSTRA-FRÖLUNDA**  
Tel: (46/31) 89 10 00  
Fax: (46/31) 49 50 99

### Malmö

Hewlett-Packard Sverige AB  
Östra Tullgatan 3  
20011 **MALMÖ**  
Box 6132  
Tel: (46/40) 702 70  
Fax: (46/40) 97 74 88

### Örebro

Hewlett-Packard Sverige AB  
Elementvägen 16  
70227 **ÖREBRO**  
Tel: (46/19) 10 48 80  
Fax: (46/19) 27 01 87

### Stockholm

Hewlett-Packard Sverige AB  
Skalholtsgatan 9, Kista  
P.O. Box 19  
16493 **KISTA**  
Tel: (46/8) 750 20 00  
Fax: (46/8) 752 77 81  
Telex: (854) 17885

## SWITZERLAND

### Basel

Hewlett-Packard (Schweiz) AG  
 Clarastrasse 12  
 4058 BÄLE  
 Tel: (41/61) 681 59 20  
 Fax: (41/61) 681 98 59  
 Telex: 964 719

### Geneva/Meyrin

Hewlett-Packard (Schweiz) AG  
 39, rue de Veyrot  
 1217 MEYRIN 1  
 Tel: (41/22) 780 41 11  
 Fax: (41/22) 782 13 68  
 Telex: 27333 HPAG CH

### Widen

Hewlett-Packard (Schweiz) AG  
 Allmend 2  
 8967 WIDEN  
 Tel: (41/57) 32 11 11  
 Telex: 828 010 hpag ch  
 Fax: (41/57) 31 73 74

## TAIWAN

Hewlett-Packard Taiwan Ltd.  
 11/F, 456, Chung Hsiao 1st Road  
 KAOHSIUNG  
 Tel: (886/7) 241-2318

Hewlett-Packard Taiwan Ltd.  
 THM Office  
 20, Kao-Shuang Road  
 PIN CHEN, Taoyuan  
 Tel: (886/3) 492-9660  
 Fax: (886/3) 492-8087

Hewlett-Packard Taiwan Ltd.  
 126-1, Sec. 2  
 Lu-Shung Road  
 TAICHUNG  
 Tel: (886/4) 237-1425

Hewlett-Packard Taiwan Ltd.  
 8/F, Hewlett-Packard Building  
 337 Fu Hsing North Road  
 TAIPEI  
 Tel: (886/2) 712-0404  
 Fax: (886/2) 715-0851

## TANZANIA

Adcom Ltd, Inc. Kenya  
 P.O. Box 30070  
 NAIROBI  
 Kenya  
 Tel: (254/2) 33 19 55  
 Telex: 0987 22639

## THAILAND

Hewlett-Packard Thailand Ltd.  
 10th floor  
 Pacific Place  
 140 Sukhumvit Road  
 BANGKOK 10110  
 Tel: (66/2) 254-6720  
 Fax: (66/2) 254-6731  
 Telex: 086 84439 Simonco TH  
 Cable: UNIMESA Bangkok

## TOGO

Engineering Business Concept (E.B.C.)  
 21, Route du Canal  
 Zone 3  
 04 B.P. 1357  
 ABIDJAN  
 Ivory Coast  
 Tel: (225) 21 50 24  
 Fax: (225) 25 27 90

## TRINIDAD & TOBAGO

Computer and Controls Ltd.  
 80-82 Edwards Street  
 P.O. Box 51  
 PORT-OF-SPAIN, Trinidad  
 Tel: (809) 624-2388/2389  
 Fax: (809) 625-6547

## TUNISIA

Precision Electronique  
 5, rue de Chypre  
 Mutuelleville  
 1002 TUNIS BELVEDERE  
 Tunisia  
 Tel: (216/1) 78 50 37  
 Telex: 0409 13238

## TURKEY

Hewlett-Packard Bilgisayar Ve Olcum  
 Sistemleri A.S.  
 Paris Caddesi No 3  
 Diare 9  
 06670 ANKARA  
 Tel: (90/4) 125 83 13  
 Fax: (90/4) 125 47 45  
 Telex: 0607 46180

Hewlett-Packard Bilgisayar Ve Olcum  
 Sistemleri A.S.  
 Mesrutiyet Mah, 19 Mayıs Cad.  
 Nova-Baran Plaza Kat: 11-12  
 SISLI / ISTANBUL  
 Tel: (90/1) 175 29 70  
 Fax: (90/1) 175 29 92  
 Telex: 0607 39 150

## UGANDA

Adcom Ltd, Inc. Kenya  
 P O Box 30070  
 NAIROBI  
 Kenya  
 Tel: (254/2) 33 19 55  
 Telex: 0987 22639

## UNION OF SOVIET SOCIALIST REPUBLICS

Hewlett-Packard Representative Office  
 Pokrovski Blvd, 4/17 KV12  
 10100 MOSCOW  
 Tel: (007/095) 923 5001  
 Fax: (007/095) 230 2611

## UNITED ARAB EMIRATES

Emitac Ltd.  
 P.O. Box 2711  
 ABU DHABI  
 Tel: (971/2) 770419  
 Fax: (971/2) 72 30 58

Emitac Ltd.  
 Block "B" Arenco Bldg.  
 Zabel Road  
 P.O. Box 8391  
 DUBAI  
 Tel: (971/4) 37 75 91  
 Fax: (971/4) 37 08 99

Emitac Ltd.  
 P.O. Box 1641  
 SHARJAH  
 Tel: (971/6) 591181  
 Telex: 0893 48710 EMITAC EM  
 Cable: EMITAC SHARJAH

## UNITED KINGDOM

### ENGLAND

#### Birmingham

Hewlett-Packard Limited  
 Avon House  
 435 Stratford Road  
 Shirley, SOLIHULL  
 West Midlands B90 4BL  
 Tel: (44/21) 745-8800  
 Fax: (44/21) 733-5104  
 Telex: 339 105

#### Bracknell

Hewlett-Packard Limited  
 Coin Road  
 BRACKNELL  
 Berkshire RG 12 IHN  
 Tel: (44/344) 36 0000  
 Fax: (44/344) 36 3344  
 Telex: 849 555

#### Central London

Hewlett-Packard Limited  
 Bridewell House  
 9 Bridewell Place  
 LONDON EC4V 6BS  
 Tel: (44/71) 583-6565  
 Fax: (44/71) 583-6565  
 Ext. 57713/57803  
 Telex: 298163

#### Gatwick

Hewlett-Packard Limited  
 Churchill Court  
 Gatwick Road  
 CRAWLEY  
 West Sussex RH10 2PN  
 Tel: (44/293) 562955  
 Fax: (44/293) 578574  
 Telex: 878862

#### Manchester

Hewlett-Packard Limited  
 Heathside Park Road  
 Cheadle Heath  
 STOCKPORT  
 Cheshire SK3 ORB  
 Tel: (44/61) 428-0828  
 Fax: (44/61) 495-5009  
 Telex: 668 068

## Uxbridge

Hewlett-Packard Limited  
 Harman House  
 No. 1 George Street  
 UXBRIDGE  
 Middlesex UB8 1YH  
 Tel: (44/895) 72020  
 Fax: (44/895) 75260  
 Telex: 893 135

## Winnersh

Hewlett-Packard Limited  
 King Street Lane  
 WINNERSH Wokingham  
 Berkshire RG 11 5AR  
 Tel: (44/734) 78 4774  
 Fax: (44/734) 77 7285  
 Telex: 847 178

## NORTHERN IRELAND

Hewlett-Packard (Ireland) Ltd.  
 Carrickfergus Industrial Centre  
 75 Belfast Road, CARRICKFERGUS  
 Co. Antrim BT38 8PM  
 Tel: (44/960) 367333

## SCOTLAND

Hewlett-Packard Ltd.  
 1/3 Springburn Place  
 College Milton North  
 EAST KILBRIDE, G74 5NU  
 Tel: (44/35) 524 92 61  
 Fax: (44/35) 523 59 29  
 Telex: 779615

Hewlett-Packard Ltd.  
 SOUTH QUEENSFERRY

West Lothian, EH30 9TG  
 Tel: (44/31) 331 11 88  
 Fax: (44/31) 331

## UNITED STATES

Hewlett-Packard Co.  
 Customer Information Center  
 Tel: (800) 752-0900  
 Hours: 6:00 AM to 5:00 PM  
 Pacific Time

## Alabama

Hewlett-Packard Co.  
 2100 Riverchase Center  
 Building 100 - Suite 118  
 BIRMINGHAM, AL 35244  
 Tel: (205) 988-0547  
 Fax: (205) 988-5308

Hewlett-Packard Co.  
 620 Discovery Dr.  
 HUNTSVILLE, AL 35806  
 Tel: (205) 830-2000  
 Fax: (205) 830-1427

## Alaska

Hewlett-Packard Co.  
 4000 Old Seward Highway  
 Suite 101  
 ANCHORAGE, AK 99503  
 Tel: (907) 563-8855  
 Fax: (907) 561-7409

**SALES OFFICES**

Arranged alphabetically by country (cont'd)

**UNITED STATES (cont'd)****Arizona**

Hewlett-Packard Co.  
8080 Pointe Parkway West  
**PHOENIX, AZ 85044**  
Tel: (602) 273-8000  
Fax: (602) 273-8080

Hewlett-Packard Co.  
3400 East Britannia Dr.  
Bldg. C, Suite 124  
**TUCSON, AZ 85706**  
Tel: (602) 573-7400  
Fax: (602) 573-7429

**Arkansas**

Hewlett-Packard Co.  
10816 Executive Center Dr  
Conway Bldg, Suite 116  
**LITTLE ROCK, AR 72211**  
Tel: (501) 225-7178  
Fax: (501) 221-3614

**California**

Hewlett-Packard Co.  
26701 W. Argoura Rd.  
**CALABASAS, CA 91302**  
Tel: (818) 880-3400  
Fax: (818) 880-3437

Hewlett-Packard Co.  
353 Lakeside Dr  
**FOSTER CITY, CA 94404**  
Tel: (415) 378-8400  
Fax: (415) 378-8405

Hewlett-Packard Co.  
1907 North Gateway Blvd.  
**FRESNO, CA 93727**  
Tel: (209) 252-9652  
Fax: (209) 456-9302

Hewlett-Packard Co.  
1421 S. Manhattan Av.  
**FULLERTON, CA 92631**  
Tel: (714) 999-6700  
Fax: (714) 778-3033

Hewlett-Packard Co.  
7408 Hollister Ave. #A  
**GOLETA, CA 93117**  
Tel: (805) 685-6100  
Fax: (805) 685-6163

Hewlett-Packard Co.  
9800 Muirlando Ave.  
**IRVINE, CA 92718**  
Tel: (714) 472-3000  
Fax: (714) 581-3607 (Direct Dial only)

Hewlett-Packard Co.  
2525 Grand Avenue  
**LONG BEACH, CA 90815**  
Tel: (213) 498-1111  
Fax: (213) 494-1986

Hewlett-Packard Co.  
5651 West Manchester Ave.  
**LOS ANGELES, CA 90045**  
Tel: (213) 337-8000  
Fax: (213) 337-8338

Hewlett-Packard Co.  
351 E. Evelyn Ave.  
Bldg. 33  
**MOUNTAIN VIEW, CA 94039**  
Tel: (415) 694-2000  
Fax: (415) 694-0600

Hewlett-Packard Co.  
5161 Lankershim Blvd.  
**NORTH HOLLYWOOD, CA 91601**  
Tel: (818) 505-5600  
Fax: (818) 505-5875

Hewlett-Packard Co.  
5725 W. Las Positas Blvd.  
**PLEASANTON, CA 94566**  
Tel: (415) 460-0282  
Fax: (415) 460-0713

Hewlett-Packard Co.  
4244 So. Market Court, Suite A  
**SACRAMENTO, CA 95834**  
Tel: (916) 929-7222  
Fax: (916) 927-7152

Hewlett-Packard Co.  
9606 Aero Drive  
**SAN DIEGO, CA 92123**  
Tel: (619) 279-3200  
Fax: (619) 268-8487

Hewlett-Packard Co.  
50 Fremont St. Suite 200  
**SAN FRANCISCO, CA 94105**  
Tel: (415) 882-6800  
Fax: (415) 882-6805

**SANTA BARBARA (see GOLETA)**

Hewlett-Packard Co.  
3003 Scott Boulevard  
**SANTA CLARA, CA 95054**  
Tel: (408) 988-7000  
Fax: (408) 988-7103

Hewlett-Packard Co.  
5280 Valentine Rd. Suite 205  
**VENTURA, CA 93003**  
Tel: (805) 658-6898  
Fax: (805) 650-0721

**Colorado**

Hewlett-Packard Co.  
3005 Center Green Drive #205  
Suite A  
**BOULDER, CO 80301**  
Tel: (303) 530-3940  
Fax: (303) 938-3025

Hewlett-Packard Co.  
24 Inverness Place, East  
**ENGLEWOOD, CO 80112**  
Tel: (303) 649-5000  
Fax: (303) 649-5787

**Connecticut**

Hewlett-Packard Co.  
3 Parkland Dr.  
**DARIEN, CT 06820**  
Tel: (203) 656-0040  
Fax: (203) 656-5563

Hewlett-Packard Co.  
115 Glastonbury Blvd  
**GLASTONBURY, CT 06033**  
Tel: (203) 633-8100  
Fax: (203) 659-6087

**District of Columbia**

(see Rockville, MD)

**Florida**

Hewlett-Packard Co.  
5900 N. Andrews, Suite 100  
**FORT LAUDERDALE, FL 33309**  
Tel: (305) 938-9800  
Fax: (305) 938-2293

Hewlett-Packard Co.  
6800 South Point Parkway  
Suite 301  
**JACKSONVILLE, FL 32216**  
Tel: (904) 636-9955  
Fax: (904) 636-9955

Hewlett-Packard Co.  
255 East Drive, Suite B  
**MELBOURNE, FL 32901**  
Tel: (407) 729-0704  
Fax: (407) 723-4557

Hewlett-Packard Co.  
6177 Lake Ellenor Drive  
**ORLANDO, FL 32809**  
Tel: (407) 859-2900  
Fax: (407) 826-9309

Hewlett-Packard Co.  
4700 Bayou Blvd.  
Building 5  
**PENSACOLA, FL 32503**  
Tel: (904) 476-8422  
Fax: (904) 476-4116

Hewlett-Packard Co.  
5550 Idlewild, #150  
**TAMPA, FL 33634**  
Tel: (813) 884-3282  
Fax: (813) 889-4445

Hewlett-Packard Co.  
2015 South Park Place  
**ATLANTA, GA 30339**  
Tel: (404) 955-1500  
Fax: (404) 980-7669

Hewlett-Packard Co.  
3607 Parkway Lane  
Suite 300  
**NORCROSS, GA 30092**  
Tel: (404) 448-1894  
Fax: (404) 246-5206

**Hawaii**

Hewlett-Packard Co.  
Pacific Tower  
1001 Bishop St.  
Suite 2400  
**HONOLULU, HI 96813**  
Tel: (808) 526-1555  
Fax: (808) 536-7873

**Idaho**

Hewlett-Packard Co.  
11309 Chinden Blvd.  
**BOISE, ID 83714**  
Tel: (208) 323-2700  
Fax: (208) 323-2528

**Illinois**

Hewlett-Packard Co.  
2205 E. Empire St.  
**BLOOMINGTON, IL 61704**  
Tel: (309) 662-9411  
Fax: (309) 662-0351

Hewlett-Packard Co.  
525 W. Monroe St., Suite 1308  
**CHICAGO, IL 60606**  
Tel: (312) 930-0010  
Fax: (312) 930-0986

Hewlett-Packard Co.  
1200 East Diehl Road  
**NAPERVILLE, IL 60566**  
Tel: (708) 505-8800  
Fax: (708) 505-7876

Hewlett-Packard Co.  
5201 Tollview Drive  
**ROLLING MEADOWS, IL 60008**  
Tel: (708) 255-9800  
Fax: (708) 259-5878

**Indiana**

Hewlett-Packard Co.  
11911 N. Meridian St.  
**CARMEL, IN 46032**  
Tel: (317) 844-4100  
Fax: (317) 843-1291

Hewlett-Packard Co.  
111 E. Ludwig Road  
Suite 108  
**FT. WAYNE, IN 46825**  
Tel: (219) 482-4283  
Fax: (219) 482-9907

**INDIANAPOLIS (see CARMEL)****Iowa**

Hewlett-Packard Co.  
4050 River Center Court  
**CEDAR RAPIDS, IA 52402**  
Tel: (319) 393-0606  
Fax: (319) 378-1024

Hewlett-Packard Co.  
4201 Corporate Dr.  
**WEST DES MOINES, IA 50265**  
Tel: (515) 224-1435  
Fax: (515) 224-1870

**Kansas**

Hewlett-Packard Co.  
North Rock Business Park  
3450 N. Rock Rd.  
Suite 300  
**WICHITA, KS 67226**  
Tel: (316) 636-4040  
Fax: (316) 636-4504

**Kentucky**

Hewlett-Packard Co.  
305 N. Hurstbourne Lane,  
Suite 100  
**LOUISVILLE, KY 40222**  
Tel: (502) 426-0100  
Fax: (502) 426-0322

**Louisiana**

Hewlett-Packard Co.  
160 James Drive East  
**ST. ROSE, LA 70087**  
Tel: (504) 467-4100  
Fax: (504) 467-4100 x 291



**Maryland**

Hewlett-Packard Co.  
3701 Koppers Street  
**BALTIMORE, MD 21227**  
Tel: (301) 644-5600  
Fax: (301) 362-7650

Hewlett-Packard Co.  
2 Choke Cherry Road  
**ROCKVILLE, MD 20850**  
Tel: (301) 258-2000  
Fax: (301) 258-5986

**Massachusetts**

Hewlett-Packard Co.  
1775 Minuteman Road  
**ANDOVER, MA 01810**  
Tel: (508) 682-1500  
Fax: (508) 794-2619

Hewlett-Packard Co.  
29 Burlington Mall Rd.  
**BURLINGTON, MA 01803-4514**  
Tel: (617) 270-7000  
Fax: (617) 221-5240

**Michigan**

Hewlett-Packard Co.  
3033 Orchard Vista S.E.  
**GRAND RAPIDS, MI 49546**  
Tel: (616) 957-1970  
Fax: (616) 956-9022

Hewlett-Packard Co.  
39550 Orchard Hill Place Drive  
**NOVI, MI 46050**  
Tel: (313) 349-9200  
Fax: (313) 349-9240

Hewlett-Packard Co.  
560 Kirts Rd.  
Suite 101  
**TROY, MI 48084**  
Tel: (313) 362-5180  
Fax: (313) 362-3028

**Minnesota**

Hewlett-Packard Co.  
2025 W. Larpenteur Ave.  
**ST. PAUL, MN 55113**  
Tel: (612) 644-1100  
Fax: (612) 641-9787

**Mississippi**

Hewlett-Packard Co.  
800 Woodland Parkway, Suite 101  
**RIDGELAND, MS 39157**  
Tel: (601) 957-0730  
Fax: (601) 957-2515

**Missouri**

Hewlett-Packard Co.  
6601 Winchester Ave.  
**KANSAS CITY, MO 64133**  
Tel: (816) 737-0071  
Fax: (816) 737-4690

Hewlett-Packard Co.  
530 Maryville Centre Drive  
**ST. LOUIS, MO 63140**  
Tel: (314) 542-1500  
Fax: (314) 542-1586

**Nebraska**

Hewlett-Packard  
11626 Nicholas St.  
**OMAHA, NE 68154**  
Tel: (402) 493-0300  
Fax: (402) 493-4334

**New Jersey**

Hewlett-Packard Co.  
120 W. Century Road  
**PARAMUS, NJ 07653**  
Tel: (201) 599-5000  
Fax: (201) 599-5382

Hewlett-Packard Co.  
10 Sylvan Way  
**PARSIPPANY, NJ 07054**  
Tel: (201) 682-4000  
Fax: (201) 682-4031

Hewlett-Packard Co.  
20 New England Ave. West  
**PISCATAWAY, NJ 08854**  
Tel: (201) 562-6100  
Fax: (201) 562-6246

**New Mexico**

Hewlett-Packard Co.  
7801 Jefferson N.E.  
**ALBUQUERQUE, NM 87109**  
Tel: (505) 823-6100  
Fax: (505) 823-1243

Hewlett-Packard Co.  
1362-C Trinity Dr.  
**LOS ALAMOS, NM 87544**  
Tel: (505) 662-6700  
Fax: (505) 662-4312

**New York**

Hewlett-Packard Co.  
5 Computer Drive South  
**ALBANY, NY 12205**  
Tel: (518) 458-1550  
Fax: (518) 458-1550 x 0393

Hewlett-Packard Co.  
130 John Muir Dr.  
**AMHERST, NY 14228**  
Tel: (716) 689-3003  
Fax: (716) 636-7034

**BUFFALO (see AMHERST)**

Hewlett-Packard Co.  
200 Cross Keys Office Park  
**FAIRPORT, NY 14450**  
Tel: (716) 223-9950  
Fax: (716) 223-6331

Hewlett-Packard Co.  
7641 Henry Clay Blvd.  
**LIVERPOOL, NY 13088**  
Tel: (315) 451-1820  
Fax: (315) 451-1820 x 255

Hewlett-Packard Co.  
No. 1 Pennsylvania Plaza  
55th Floor  
34th Street & 7th Avenue  
**MANHATTAN NY 10119**  
Tel: (212) 971-0800  
Fax: (212) 330-6967

Hewlett-Packard Co.  
7 Old Sod Farm Road  
**MELVILLE, NY 11714**  
Tel: (516) 753-0555  
Fax: (516) 753-3469

Hewlett-Packard Co.  
2975 Westchester Ave  
**PURCHASE, NY 10577**  
Tel: (914) 935-6300  
Fax: (914) 935-6497

**ROCHESTER (see FAIRPORT)****SYRACUSE (see LIVERPOOL)**

Hewlett-Packard Co.  
Executive Square Office Bldg.  
66 Middlebush Rd.  
**WAPPINGERS FALLS, NY 12590**  
Tel: (914) 298-9125  
Fax: (914) 298-9154

**North Carolina**

Hewlett-Packard Co.  
305 Gregson Dr.  
**CARY, NC 27511**  
Tel: (919) 467-6600  
Fax: (919) 460-2296  
(919) 460-2297

Hewlett-Packard Co.  
P.O. Box 240318  
**CHARLOTTE, NC 28224**  
Tel: (704) 527-8780  
Fax: (704) 523-7857

Hewlett-Packard Co.  
7029 Albert Pick Rd. #100  
**GREENSBORO, NC 27409**  
Tel: (919) 665-1800  
Fax: (919) 688-1797  
Mailing Address  
PO Box 26500  
Greensboro, NC 27426

**RALEIGH (see CARY)****Ohio**  
**AKRON (see COPLEY)**

Hewlett-Packard Co.  
4501 Erskine Road  
**CINCINNATI, OH 45242**  
Tel: (513) 891-9870  
Fax: (513) 891-0033

**CLEVELAND (see STRONGSVILLE)**

Hewlett-Packard Co.  
Montrose West Ave.  
**COPLEY, OH 44321**  
Tel: (216) 666-7711  
Fax: (216) 666-6054

Hewlett-Packard Co.  
7887 Washington Village Dr.  
**DAYTON, OH 45459**  
Tel: (513) 433-2223  
Fax: (513) 433-8633

Hewlett-Packard Co.  
15885 Sprague Road  
**STRONGSVILLE, OH 44136**  
Tel: (216) 243-7300  
Fax: (216) 234-7230

Hewlett-Packard Co.  
One Maritime Plaza, 5th Floor  
720 Water Street  
**TOLEDO, OH 43604**  
Tel: (419) 242-2200  
Fax: (419) 241-7655

Hewlett-Packard Co.  
675 Brooksedge Blvd.  
**WESTERVILLE, OH 43081**  
Tel: (614) 891-3344  
Fax: (614) 891-1476

**Oklahoma**

Hewlett-Packard Co.  
3525 N.W. 56th St.  
Suite C-100  
**OKLAHOMA CITY, OK 73112**  
Tel: (405) 946-9499  
Fax: (405) 942-2127

Hewlett-Packard Co.  
6655 South Lewis,  
Suite 105  
**TULSA, OK 74136**  
Tel: (918) 481-6700  
Fax: (918) 481-2250

**Oregon****EUGENE (see WILSONVILLE)**

Hewlett-Packard Co.  
9255 S. W. Pioneer Court  
**WILSONVILLE, OR 97070**  
Tel: (503) 484-4085  
Fax: (503) 682-8155

**Pennsylvania**

Hewlett-Packard Co.  
Heatherwood Industrial Park  
50 Dorchester Rd.  
P.O. Box 6080  
**HARRISBURG, PA 17112**  
Tel: (717) 657-5900  
Fax: (717) 657-5946

Hewlett-Packard Co.  
111 Zeta Drive  
**PITTSBURGH, PA 15238**  
Tel: (412) 782-0400  
Fax: (412) 963-1300

Hewlett-Packard Co.  
2750 Monroe Boulevard  
**VALLEY FORGE, PA 19482**  
Tel: (215) 666-9000  
Fax: (215) 666-2034

**South Carolina**

Hewlett-Packard Co.  
Brookside Park, Suite 122  
1 Harbison Way  
**COLUMBIA, SC 29212**  
Tel: (803) 732-0400  
Fax: (803) 732-4567

Hewlett-Packard Co.  
545 N. Pleasantburg Dr.  
Suite 100  
**GREENVILLE, SC 29607**  
Tel: (803) 232-8002  
Fax: (803) 232-8739

**Tennessee**

Hewlett-Packard Co.  
One Energy Center Suite 200  
Pelissipipi Pkwy.  
**KNOXVILLE, TN 37932**  
Tel: (615) 966-4747  
Fax: (615) 966-8147

**SALES OFFICES**

Arranged alphabetically by country (cont'd)

**UNITED STATES (cont'd)****Tennessee (cont'd)**

Hewlett-Packard Co.  
889 Ridge Lake Blvd.,  
Suite 100

**MEMPHIS, TN** 38119  
Tel: (901) 763-4747  
Fax: (901) 762-9723

Hewlett-Packard Co.  
44 Vantage Way,  
Suite 160

**NASHVILLE, TN** 37228  
Tel: (615) 255-1271  
Fax: (615) 726-2310

**Texas**

Hewlett-Packard Co.  
9050 Capital of Texas Highway, North  
#290

**AUSTIN, TX** 78759  
Tel: (512) 346-3855  
Fax: (512) 338-7201

Mailing Address  
PO Box 9431  
Austin, TX 78766-9430

**DALLAS (see RICHARDSON)**

Hewlett-Packard Co.  
5700 Cromo Dr  
**EL PASO, TX** 79912  
Tel: (915) 833-4400  
Fax: (915) 581-8097

Hewlett-Packard Co.  
10535 Harwin Drive  
**HOUSTON, TX** 77036  
Tel: (713) 776-6400  
Fax: (713) 776-6495

Hewlett-Packard Co.  
3301 West Royal Lane  
**IRVING, TX** 75063  
Tel: (214) 869-3377  
Fax: (214) 830-8951

Hewlett-Packard Co.  
109 E. Toronto, Suite 100  
**McALLEN, TX** 78503  
Tel: (512) 630-3030  
Fax: (512) 630-1355

Hewlett-Packard Co.  
930 E. Campbell Rd.  
**RICHARDSON, TX** 75081  
Tel: (214) 231-6101  
Fax: (214) 699-4337

Hewlett-Packard Co.  
14100 San Pedro Ave., Suite 100  
**SAN ANTONIO, TX** 78232  
Tel: (512) 494-9336  
Fax: (512) 491-1299

**Utah**

Hewlett-Packard Co.  
3530 W. 2100 South  
**SALT LAKE CITY, UT** 84119  
Tel: (801) 974-1700  
Fax: (801) 974-1780

**Virginia**

Hewlett-Packard Co.  
840 Greenbrier Circle  
Suite 101  
**CHESAPEAKE, VA** 23320  
Tel: (804) 424-7105  
Fax: (804) 424-1494

Hewlett-Packard Co.  
4401 Water Front Dr.  
**GLEN ALLEN, VA** 23060  
Tel: (804) 747-7750  
Fax: (804) 965-9297

**NORFOLK (see CHESAPEAKE)****RICHMOND (see GLEN ALLEN)**

Hewlett-Packard Co.  
2800 Electric Road Suite 100  
**ROANOKE, VA** 24018  
Tel: (703) 774-3444  
Fax: (703) 989-8049

**Washington**

Hewlett-Packard Co.  
15815 S.E. 37th Street  
**BELLEVUE, WA** 98006  
Tel: (206) 643-4000  
Fax: (206) 643-8748

Hewlett-Packard Co.  
N. 1225 Argonne Rd  
**SPOKANE, WA** 99212-2657  
Tel: (509) 922-7000  
Fax: (509) 927-4236

**Washington, D.C.**

(see Rockville, MD)

**West Virginia**

Hewlett-Packard Co.  
501 56th Street  
**CHARLESTON, WV** 25304  
Tel: (304) 925-0492  
Fax: (304) 925-1910

**Wisconsin**

Hewlett-Packard Co.  
275 N. Corporate Dr.  
**BROOKFIELD, WI** 53005  
Tel: (414) 792-8800  
Fax: (414) 792-0218

Hewlett-Packard Co.  
333 Main St.  
**GREEN BAY, WI** 54301  
Tel: (414) 436-2780  
Fax: (414) 436-2786

**MILWAUKEE (see BROOKFIELD)****URUGUAY**

Pablo Ferrando S.A.C. e l.  
Avenida Italia 2877  
Casilla de Correo 370  
**MONTEVIDEO**  
Tel: (598/2) 802 586  
Telex: 398802586

**VENEZUELA**

Hewlett-Packard de Venezuela, C.A.  
Tercera Transversal  
Los Ruices Norte  
Edificio Segre, **CARACAS**  
Tel: (58/2) 239 4133/4244  
Fax: (58/2) 239 3080

**YUGOSLAVIA**

Do Hermes  
General Zdanova 4  
YU-11000 **BEOGRAD**  
Tel: (38/11) 342 641  
Telex: 11433

Do Hermes  
Celovska 73  
YU-61000 **LJUBLJANA**  
Tel: (38/61) 553 170  
Telex: 31583

**ZAMBIA**

R.J. Tilbury (Zambia) Ltd.  
P.O. Box 32792  
**LUSAKA**  
Tel: (260/1) 21 55 80  
Telex: 0902 40128

**ZIMBABWE**

Field Consolidated (Private) Ltd.  
Systron Division  
Manhattan Court  
61 Second Street  
P.O. Box 3458  
**HARARE**  
Tel: (263/4) 73 98 81  
Fax: (263/4) 70 20 08  
Telex: 26241

**Please send directory corrections to:**

Test & Measurement Catalog, 54AF  
Hewlett-Packard Company  
5301 Stevens Creek Blvd.  
P.O. Box 58059  
Santa Clara, CA 95052-8059  
Tel: (408) 553-7271  
Fax: (408) 983-1006

September 1990

# APPLICATION & PRODUCT NOTES

## Free Aids to Solving Your Test and Measurement Problems

747

Application Notes

Application Notes help you use HP instruments to solve measurement problems. They are application-specific and typically include generic techniques with families of products.

Product Notes describe measurement techniques that are product-specific and often show extensions of performance outside normal lab environments, including performance data and explanations of specifications.

### How to Order

To obtain a free copy of any of the Application Notes or Product Notes listed on the following pages, just call your HP Customer Information Center (CIC) or your nearest HP office (see page 737). You can also order Application Notes and Product Notes with the information request card inside the rear cover of this catalog. When requesting these publications, please include the complete number (for example, AN 243-4/5952-7250).

## Application Notes

### A to D Converters

Fundamentals of the z-Domain and Mixed Analog/Digital Measurements  
AN 243-4/5952-7250

Interconnecting Two or More HP 5180A Waveform Recorders to Obtain Multiple Input Channels  
AN 313-7/5952-7670

Rotation Simulation and ADC Testing with Synthesized Signals  
AN 373/5952-9693

Using the Direct Memory Access Capability of the HP 5180A Waveform Recorder with the HP 9826 Desktop Computer  
AN 313-8/5952-7710

Using the HP 5183T to Characterize Sonar Transducers and Systems  
AN 340-1/5952-7805

### Air Navigation

Characterizing Barker Coded Modulation in Radar Systems  
AN 358-10/5952-8004

Characterizing Chirp Coded Modulation in Radar Systems  
AN 358-11/5952-8005

Modulation Domain Techniques for Measuring Complex Radar Signals  
AN 358-9/5952-8003

### Amplifiers

Accurate Mixer/Amplifier Compression Measurement Using the 8901A Modulation Analyzer  
AN 286-2/5952-8245

Amplifier Measurements Using the Scalar Network Analyzer  
AN 345-1/5954-1599

Complete S-Parameter and Distortion Measurement for Wide Band Video Amplifiers with the HP 4195A  
AN 357-2/5950-2932

Extending Dynamic Range of Scalar Transmission Measurements  
AN 327-1/5953-8882

Fundamentals of RF and Microwave Noise Figure Measurement  
AN 57-1/5952-8255

Harmonic Distortion Measurements  
AN 378-1/5952-7253

Noise Figure Measurement Accuracy  
AN 57-2/5952-3706

S-Parameter Techniques for Faster, More Accurate Network Design  
AN 95-1/5952-1130

### Audio

Analyzing Phase-Locked Loop Transients in the Modulation Domain  
AN 358-7/5952-8001

Fundamentals of the z-Domain and Mixed Analog/Digital Measurements  
AN 243-4/5952-7250

High Speed Measurement of Semiconductor Devices from Sub-PA to 1A  
AN 356/5950-2930

Log Sweep with the HP 3582A Spectrum Analyzer  
AN 245-5/5952-8805

The Fundamentals of Signal Analysis  
AN 243/5952-8898

Harmonic Distortion Measurements  
AN 378-1/5952-7253

### Automatic Test Systems

Appliance Testing  
AN 421-24/5954-9654

Battery Testing  
AN 372-2/5952-4191

Communications Cable Testing  
AN 421-8/5954-9638

Environmental/Autoclave Testing  
AN 421-7/5954-9637

Jet Engine Controller Testing  
AN 421-5/5954-9635

Jet Engine Testing  
AN 421-16/5954-9646

Large Product Characterization  
AN 421-18/5954-9648

Low Phase Noise Applications of the HP 8662A and 8663A Synthesized Signal Generators  
AN 283-3/5953-8435

Machine Monitoring and Control  
AN 421-20/5954-9650

Materials Development  
AN 421-12/5954-9642

Microwave Switching from SPDT to Full Access Matrix  
AN 332/5953-6466

Millimeter Measurements Using the HP 3048A Phase Noise Measurement System  
AN 385/5951-6749

Missile System Testing  
AN 421-19/5954-9649

Non-contact Measurements with Laser Interferometer  
AN 325-12/5952-8022

Novel Combinations of Microwave Switches and Step Attenuators  
AN 332-1/5954-8892

Power Supply Testing  
AN 372-1/5952-4190

Practical Test System Signal Switching  
AN 328-1/5953-6962

Pulsed Carrier Phase Noise Measurements Using the HP 3048A Phase Noise Measurement System  
AN 386/5951-6743

Reducing Fixture-Induced Test Failures  
AN 340-1/5952-7805

Troubleshooting Microprocessor-based Systems Using the HP 5180A Waveform Recording  
AN 313-1/5952-7634

Using the HP 3497A to Control Industrial Wastewater Treatment  
AN 290-2/5953-6921

Using the HP 5183T to Characterize Sonar Transducers and Systems  
AN 340-1/5952-7805

### Battery Charging/Discharging

Battery Charging/Discharging  
AN 250-2/5952-4033

Battery Testing  
AN 421-14/5954-9644

Battery Testing  
AN 372-2/5952-4191

### Cable

Advanced TDR Techniques for use with the HP 54120 Family of Digitizing Oscilloscopes  
AN 62-3/5952-1141

Communications Cable Testing  
AN 421-8/5954-9638

Direct Radio Frequency Impedance Measurements Using the 4191A RF Impedance Analyzer  
AN 302-1/5952-8853

Measuring Electrical Length Delay of Cables  
AN 174-10/5952-7326

Measuring the Characteristic Impedance of Balanced Cables Using the HP 4194A  
AN 339-4/5950-2918

TDR Fundamentals for use with HP 54120T Digitizing Oscilloscope  
AN 62/5954-2681

TDR Techniques for Differential Systems for use with the HP 54120 Family of Digitizing Oscilloscopes  
AN 62-2/5952-0154

### Calibration

Applications and Operation of the 8901A Modulation Analyzer  
AN 286-1/5952-8208

Calibrated Signal Simulation System Utilizing I/Q Modulation Techniques  
AN 343-5/5952-6471

Characterization of Frequency-Agile Sources with HP 5371A Frequency, Time Interval Analyzer  
AN 358-1/5952-7924

Effective Machinery Maintenance Using Vibration Analysis  
AN 243-1/5953-5113

HP 8640A/B Signal Generator Output Level Accuracy  
AN 170-1/5952-1218

High Frequency Swept Measurements  
AN 183/5952-9200

Jitter and Wander Analysis in Digital Communication with the HP 5371A Frequency and Time Interval Analyzer  
AN 358-2/5952-7925

Microwave Switching from SPDT to Full Access Matrix  
AN 332/5953-6466

Noise Figure Measurement Accuracy  
AN 57-2/5952-3706

Signal Generator Spectral Purity  
AN 388/5952-2019

Simplify Frequency Stability Measurements With Built-in Allan Variance Analysis  
AN 358-12/5952-8006

Simulating Sensor Signals  
AN 341-2/5952-9651

Using the HP 5183T to Characterize Sonar Transducers and Systems  
AN 340-1/5952-7805

# APPLICATION & PRODUCT NOTES

## Free Aids to Solving Your Test and Measurement Problems

### Application Notes

#### Coaxial Systems

Advanced TDR Techniques for use with the HP 54120 Family of Digitizing Oscilloscopes AN 62-3/5952-1141

Clock Rate Independent Jitter Measurements for Digital Communications Systems AN 358-5/5952-7999

Configuration of a Two-tone Sweeping Generator AN 312-1/5952-9316

Extending Dynamic Range of Scalar Transmission Measurements Using the HP 8757A, 8756A, or 8755C Scalar Network Analyzers AN 327-1/5953-8882

High Frequency Swept Measurements AN 183/5952-9200

Microwave Switching from SPDT to Full Access Matrix AN 332/5953-6466

Novel Combinations of Microwave Switches and Step Attenuators for Programming Applications AN 332-1/5953-8892

Principles Of Microwave Connector Care AN 326/5954-1566

Protocol Converters: Linking HP Graphics Peripherals with IBM Networks/Systems AN 229-11/5953-9874

TDR Fundamentals for use with HP 54120T Digitizing Oscilloscope and TDR AN 62/5954-2681

#### Communications

A Guide to Microwave Upconversion AN 314-5/5953-2342

Analyzing Phase-Locked Loop Transients in the Modulation Domain AN 358-7/5952-8001

Benefits of P/AR AN 318-1/5952-4996D

Characterization of Frequency Agile Sources with HP 5371A Frequency, Time Interval Analyzer AN 358-1/5952-7924

Clock Rate Independent Jitter Measurements for Digital Communications Systems AN 358-5/5952-7999

Communications Cable Testing AN 421-8/5954-9638

Exceptionally Complex Signal Simulation for Multi-Signal Environments in Radar/EW Test AN 314-4/5952-3702

Fundamentals of Electronic Frequency Counters AN 200/5952-7506

High Speed Timing Acquisition and Statistical Jitter Analysis Using HP 5370B Universal Time Interval Counter AN 191-7/5952-7908

How to Measure Return Loss of Connectorized Optical Components AN 366-2/5952-9661

ISDN 23B&D PAR and DMI Testing Using the HP 3787B and Protocol Analyzer AN 368/5959-8215

Jitter and Wander Analysis in Digital Communication with the HP 5371A Frequency and Time Interval Analyzer AN 358-2/5952-7925

Large Product Characterization AN 421-18/5954-9648

Low Phase Noise Applications of the HP 8662A and 8663A Synthesized Signal Generators AN 283-3/5953-8435

Measurements Applications for Digital Microwave Radio AN 343-1/5954-6365

Measuring Digital Microwave Radio M-Curves/Signatures AN 379-1/5959-7859

Microwave Switching from SPDT to Full Access Matrix AN 332/5953-6466

Millimeter Measurements Using the HP 3048A Phase Noise Measurement System AN 385/5951-6749

Missile System Testing AN 421-19/5954-9649

Pulsed Carrier Phase Noise Measurements Using the HP 3048A Phase Noise Measurement System AN 386/5951-6743

Signal Generator Spectral Purity AN 388/5952-2019

Single-Shot BPSK Signal Characterization AN 358-5/5952-8002

Voltage Controlled Oscillators Characterization Using the HP 5350B, 5351B, 5352B CW Microwave Frequency Counter AN 181-2/5952-7852

#### Component Test

A Guideline for Designing External DC Current Bias Circuits for the HP 4192A, HP 4194A, HP 4274A, HP 4275A, HP 4276A, and HP 4277A AN 346/5950-2912

A Test Set-Up for Characterizing High-Speed Logic Devices AN 381/5953-6329

Accurate Mixer/Amplifier Compression Measurement Using the 8901A Modulation Analyzer AN 286-2/5952-8245

Advanced Filter Evaluation and Limit Testing with the HP 4195A AN 357-3/5950-2933

Amplifier Measurements Using the Scalar Network Analyzer AN 345-1/5954-1599

Analysis of Semiconductor Capacitance Characteristics Using the HP 4280A 1 MHz C Meter/C-V Plotter AN 322/5953-6939

Analyzing Phase-Locked Loop Transients in the Modulation Domain AN 358-7/5952-8001

Automated Characterization of Microwave Voltage Controlled Oscillators Using the HP 5361A Pulse/CW Microwave Counter AN 377-2/5952-7988

Biasing Three-Terminal Devices for Test AN 376-1/5952-4193

Characteristic Impedance Measurement of PC Board Circuit Patterns Using the HP 4194A Impedance/Gain-Phase Analyzer AN 339-2/5950-2908

Characterization of Frequency Agile Sources with the HP 5371A Frequency and Time Interval Analyzer AN 358-1/5952-7924

Complete S-Parameter and Distortion Measurement for Wide Band Video Amplifiers with the HP 4195A AN 357-2/5950-2932

Constant Current Measurements Using the HP 4194A AN 339-8/5950-2923

Crosstalk and Impedance Measurements of PC Board Patterns - HP 4194A Application Information AN 339-3/5950-7863

Dielectric Constant Measurement of Solid Materials AN 380-1/5950-2390

Direct Radio Frequency Impedance Measurements Using the 4191A RF Impedance Analyzer AN 302-1/5952-8853

Disk Drive Servo-Track Writing with Laser Interferometers AN 325-11/5952-7984

Dynamic Component Test Using Vector Modulation Analysis AN 343-2/5954-6367

Efficient Evaluation of LISNs and Voltage Probes for EMI Tests using the HP 4194A AN 339-7/5950-2922

Efficient Evaluation of LISNs and Voltage Probes for EME Tests Using the HP 4194A AN 339-7/5950-2922

Filter Test for Production and Incoming Inspection - HP 4194A AN 339-11/5952-7887

Fundamentals of Electronic Frequency Counters AN 200/5952-7506

Fundamentals of RF and Microwave Noise Figure Measurement AN 57-1/5952-8255

HP-IB Programming Hints for the HP 4194A AN 339-12/5950-2929

Harmonic Distortion Measurements AN 378-1/5952-7253

How to Measure Return Loss of Connectorized Optical Components AN 366-2/5952-9661

Impedance Characterization of High Q Devices from 1 MHz to 1000 MHz with 1 Hz Resolution AN 302-2/5952-8872

Impedance Characterization of Resonators Using the HP 4194A AN 339-1/5950-2882

Impedance Measurement for Incoming Inspection - HP 4284A Application Information AN 369-4/5950-2952

Input/Output Impedance and Reflection Coefficient Measurements using the HP 4194A AN 339-10/5950-2925

Magnetic Head Measurement Using a Constant Test Current - HP 4284A Application Information AN 369-3/5950-2951

Measuring Cable Parameters AN 380-2/5950-2399

Measuring the Characteristic Impedance of Balanced Cables Using the HP 4194A AN 339-4/5950-2918

Measuring the Dielectric Constant of Solid Materials - HP 4194A Impedance/Gain-Phase Analyzer AN 339-13/5950-2935

Microwave Switching from SPDT to Full Access Matrix AN 332/5953-6466

Multi-frequency C-V Measurements of Semiconductors - HP 4284A Application Information AN 369-5/5950-2953

Multi-frequency C-V Measurements and Doping Profile Analysis of Semiconductors Using the HP 4194A AN 339-5/5950-2919

Negative Impedance Measurements of Crystal Oscillators Using the HP 4194A

AN 339-9/5950-2924

Network, Spectrum, and Impedance Evaluation of IF Circuits - HP 4195A Network/Spectrum Analyzer

AN 357-1/5950-2931

Noise Figure Measurement Accuracy

AN 57-2/5952-3706

Parametric Analysis for Electronic Components and Circuit Evaluation Using the HP 4194A

AN 339/5950-2856

Practical Design and Evaluation of High Frequency Circuits Using the HP 4193A Vector Impedance Meter

AN 317/5953-6910

Pre-Trigger Simplifies VCO Step Response Measurements

AN 358-4/5952-7998

Role of DC Parametric Test in High Speed Digital and Microwave Component Manufacturing

AN 339-20/5952-7936

Rotation Simulation and ADC Testing with Synthesized Signals

AN 373/5952-9693

Semiconductor Measurements with the HP 4140B Picoammeter/DC Voltage Source

AN 238/5952-8840

Simplify Frequency Stability Measurements With Built-in Allan Variance Analysis

AN 358-12/5952-8006

Static Head Testing for Disc Drives - HP 4194A Application Information

AN 339-6/5952-7871

Static Head Testing for Disk Drives - HP 4194A Application

AN 339-6/5952-7871

Tantalum Capacitor Measurement - HP 4284A Application Information

AN 369-2/5950-2950

Ultra Low Current Semiconductor DC Parameter Measurement System Using HP 4140B

AN 238-1/5952-8873

Using Impedance Measurement to Evaluate Electronic Components and Materials - HP 4284A Application Information

AN 369-1/5950-2949

Voltage Controlled Oscillators Characterization Using the HP 5350B, 5351B, 5352B CW Microwave Frequency Counter

AN 181-2/5952-7852

### Computer Aided Engineering

Line Quality and Accuracy - What They Are and How to Achieve Them

AN 350-4/5954-7132

The Fundamentals of Modal Testing

AN 243-3/5954-7957

Using AutoCAD with Hewlett-Packard Large-Format Pen Plotters

AN 350-7/5959-9744

Using Your HP Plotter or Printer with 3Com's 3 +Share PC Server

AN 350-8/5952-2255

Using your Plotter or Printer with Peripheral Sharing Devices, Buffers, and Spoolers

AN 350-6/5959-9713

### Computer Aided Test

See Data Acquisition

### Crystals

Crystal Testing with the 8640A/B and 8405A

AN 171-1/5952-8117

Direct Radio Frequency Impedance Measurements Using the 4191A RF Impedance Analyzer

AN 302-1/5952-8853

Fundamentals of Electronic Frequency Counters

AN 200/5952-7506

Fundamentals of Quartz Oscillators

AN 200-2/5952-7507

Impedance Characterization of High Q Devices from 1 MHz to 1000 MHz with 1 Hz Resolution

AN 302-2/5952-8872

Practical Design and Evaluation of High Frequency Circuits Using the HP 4193A Vector Impedance Meter

AN 317/5953-6910

Simplify Frequency Stability Measurements With Built-in Allan Variance Analysis

AN 358-12/5952-8006

### Crystal Filters

Analyzing Phase-Locked Loop Transients in the Modulation Domain

AN 358-7/5952-8001

Crystal Testing with the 8640A/B and 8405A

AN 171-1/5952-8117

Efficient Evaluation of LISNs and Voltage Probes for EMI Tests Using the HP 4194A

AN 339-7/5950-2922

Filter Test for Production and Incoming Inspection - HP 4194A Impedance/Gain-Phase Analyzer

AN 339-11/5952-7887

Negative Impedance Measurements of Crystal Oscillators Using the HP 4194A

AN 339-9/5950-2924

### Data Acquisition

Air Frame Testing

AN 421-25/5954-9655

Appliance Testing

AN 421-24/5954-9654

Battery Testing

AN 421-14/5954-9644

Battery Testing

AN 372-2/5952-4191

Bed of Nails Test: DA Converter

AN 421-29/5954-9659

Biasing Three-Terminal Devices for Test

AN 376-1/5952-4193

Canning Process Characterization

AN 421-10/5954-9640

Communications Cable Testing

AN 421-8/5954-9638

Data Acquisition and Computer Aided Test Application Notes for 32 Industries in Series

AN 421-1/5954-9631

Environment Test Electrical Sub-assembly

AN 421-32/5954-9662

Environmental Test Auto Radio

AN 421-30/5954-9660

Environmental/Autoclave Testing

AN 421-7/5954-9637

Explosion Testing

AN 421-11/5954-9641

Facility Management

AN 421-17/5954-9647

Fan Testing

AN 421-2/5954-9632

Fundamentals of Data Acquisition

AN 290/5952-2592

Fundamentals of Modal Testing

AN 243-3/5954-7957

High Speed Timing Acquisition and Statistical Jitter Analysis Using the HP 5370B Universal Time Interval Counter

AN 191-7/5952-7908

Internal Combustion Engine Testing

AN 421-6/5954-9636

Jet Engine Controller Testing

AN 421-5/5954-9635

Jet Engine Testing

AN 421-16/5954-9646

Large Product Characterization

AN 421-18/5954-9648

Machine Monitoring and Control

AN 421-20/5954-9650

Materials Development

AN 421-12/5954-9642

Microwave Switching from SPDT to Full Access Matrix

AN 332/5953-6466

Missile System Testing

AN 421-19/5954-9649

Non-contact Measurements with Laser Interferometer

AN 325-12/5952-8022

On-Road Vehicle Testing

AN 421-26/5954-9656

Paper Process Control

AN 421-22/5954-9652

Pharmaceutical Process Control

AN 421-21/5954-9651

Pilot Plant Monitoring

AN 421-15/5954-9645

Plating Line Control

AN 421-13/5954-9643

Power Supply Testing

AN 372-1/5952-4190

Practical Strain Gauge Measurements

AN 290-1/5952-8880

Practical Temperature Measurements

AN 290/5952-8801

Pumping Station Control

AN 421-27/5954-9657

Receiver Testing

AN 421-28/5954-9658

Residential Facility Monitoring

AN 421-9/5954-9639

Role of DC Parametric Test in High Speed Digital and Microwave Component Manufacturing

AN 339-20/5952-7936

Rolling Mill

AN 421-23/5954-9653

Sonar System Testing

AN 421-31/5954-9661

Sub-Micro Positioning with the HP 5527A Laser Position Transducer System

AN 325-10/5952-7942

Using the HP 3497A to Control Industrial Wastewater Treatment

AN 290-2/5953-6921

Vehicle Body Testing

AN 421-3/5954-9633

Waste Water Treatment

AN 421-4/5954-9634

### Digital Communications

Analyzing Phase-Locked Loop Transients in the Modulation Domain

AN 358-7/5952-8001

# APPLICATION & PRODUCT NOTES

## Free Aids to Solving Your Test and Measurement Problems

### Application Notes

- Benefits of P/AR AN 318-1/**5952-4996D**
- Characterization of Frequency-Agile Sources with HP 5371A Frequency, Time Interval Analyzer AN 358-1/**5952-7924**
- Characterizing Transient Timing Errors in Disk and Tape Drives AN 358-6/**5952-8000**
- Clock Rate Independent Jitter Measurements for Digital Communications Systems AN 358-5/**5952-7999**
- Digital Radio Theory and Measurements AN 355/**5954-9554**
- Fundamentals of Electronic Frequency Counters AN 200/**5952-7506**
- High Speed Timing Acquisition and Statistical Jitter Analysis Using the HP 5370B Universal Time Interval Counter AN 191-7/**5952-7908**
- ISDN 23B&D PAR and DMI Testing Using the HP 3787B and Protocol Analyzer AN 368/**5959-8215**
- Jitter and Wander Analysis in Digital Communication with the HP 5371A Frequency and Time Interval Analyzer AN 358-2/**5952-7925**
- Measurements Applications for Digital Microwave Radio AN 343-1/**5954-6365**
- Measuring Demodulator Image Rejection Using the HP 8980A Vector Analyzer AN 343-4/**5952-3703**
- Measuring Digital Microwave Radio M-Curves/Signatures AN 379-1/**5959-7859**
- Measuring Microwave Radio Antenna Return Loss Using the HP 11758T Digital Radio Test System AN 379-2/**5959-8749**
- Simulating Sensor Signals AN 343-5/**5952-6471**
- Digital Troubleshooting**  
*See Troubleshooting*
- Distortion**  
Harmonic Distortion Measurements AN 378-1/**5952-7253**
- Non-contact Measurements with Laser Interferometer AN 325-12/**5952-8022**
- Optimizing the Dynamic Range of the HP 3585A Spectrum Analyzer AN 246-1/**5952-8815**
- The 8640A/B Third Order Intermodulation Product Characteristics AN 170-2/**5952-8129**
- EMI**  
Automatic CISPR EMI Testing for Conducted Emissions AN 331-1/**5954-2724**
- Electronic Warfare (EW)**  
A Guide to Microwave Upconversion AN 314-5/**5953-2342**
- Analyzing Phase-Locked Loop Transients in the Modulation Domain AN 358-7/**5952-8001**
- Automatic Frequency Profiling of Chirped Radar Pulses Using the HP 5361A Pulse/CW Microwave Counter AN 377-1/**5952-7987**
- Characterization of Frequency Agile Sources with the HP 5371A Frequency and Time Interval Analyzer AN 358-1/**5952-7924**
- Characterizing Barker Coded Modulation in Radar Systems AN 358-10/**5952-8004**
- Characterizing Chirp Coded Modulation in Radar Systems AN 358-11/**5952-8005**
- Coherent Pulsed Tests of Radar and EW Systems AN 343-3/**5954-6366**
- Dynamic Component Test Using Vector Modulation Analysis AN 343-2/**5954-6367**
- Exceptionally Complex Signal Simulation for Multi-Signal Environments in Radar/EW Test AN 314-4/**5952-3702**
- Fundamentals of Electronic Frequency Counters AN 200/**5952-7506**
- High Speed Timing Acquisition and Statistical Jitter Analysis Using the HP 5370B Universal Time Interval Counter AN 191-7/**5952-7908**
- Microwave Switching from SPDT to Full Access Matrix AN 332/**5953-6466**
- Modulation Domain Techniques for Measuring Complex Radar Signals AN 358-9/**5952-8003**
- Obtaining Leveled Pulse-Modulated Microwave Signals from the HP 8672A AN 218-5/**5952-8251**
- Practical Strain Gauge Measurements AN 290-1/**5952-8880**
- Voltage Controlled Oscillators Characterization Using the HP 5350B, 5351B, 5352B CW Microwave Frequency Counter AN 181-2/**5952-7852**
- Error Analysis**  
Direct Radio Frequency Impedance Measurements Using the 4191A RF Impedance Analyzer AN 302-1/**5952-8853**
- Fundamentals of RF and Microwave Power Measurement AN 64-1/**5952-8178**
- HP 8640A/B Signal Generator Output Level Accuracy AN 170-1/**5952-1218**
- High Frequency Swept Measurements AN 183/**5952-9200**
- High Speed Timing Acquisition and Statistical Jitter Analysis Using the HP 5370B Universal Time Interval Counter AN 191-7/**5952-7908**
- Integrated Services Digital Network (ISDN) 23B&D Primary Access Rate (PAR) and Digital Multiplexed Interface (DMI) Testing Using the HP 3787B and Protocol Analyzer AN 368/**5959-8215**
- Jitter and Wander Analysis in Digital Communication with the HP 5371A Frequency and Time Interval Analyzer AN 358-2/**5952-7925**
- Fiber Optics**  
*See Lightwave*
- Fourier Analysis**  
Accessing the HP 3582A Memory with HP-IB AN 245-4/**5952-8804**
- Effective Machinery Maintenance Using Vibration Analysis AN 243-1/**5953-5113**
- Fundamentals of Modal Testing AN 243-3/**5954-7957**
- Fundamentals of Signal Analysis AN 243/**5952-8898**
- Fundamentals of the z-Domain and Mixed Analog/Digital Measurements AN 243-4/**5952-7250**
- Log Sweep with the HP 3582A Spectrum Analyzer AN 245-5/**5952-8805**
- Non-contact Measurements with Laser Interferometer AN 325-12/**5952-8022**
- Frequency**  
Analyzing Phase-Locked Loop Transients in the Modulation Domain AN 358-7/**5952-8001**
- Applications and Operation of the 8901A Modulation Analyzer AN 286-1/**5952-8208**
- Characterizing Barker Coded Modulation in Radar Systems AN 358-10/**5952-8004**
- Characterizing Chirp Coded Modulation in Radar Systems AN 358-11/**5952-8005**
- Clock Rate Independent Jitter Measurements for Digital Communications Systems AN 358-5/**5952-7999**
- Crystal Testing with the 8640A/B and 8405A AN 171-1/**5952-8117**
- Frequency Profile Using an HP 5370A Universal Time Interval Counter and an HP 5359A Time Synthesizer AN 287-3/**5952-7549**
- Frequency Profile Using an HP 5345A Time Synthesizer AN 287-2/**5952-7530**
- Fundamentals of Electronic Frequency Counters AN 200/**5952-7506**
- Fundamentals of Microwave Frequency Counters AN 200-1/**5952-7484**
- Fundamentals of Modal Testing AN 243-3/**5954-7957**
- Fundamentals of Quartz Oscillators AN 200-2/**5952-7507**
- Measuring Fractional Frequency Standard Deviation (Sigma) Versus Averaging Time (TAU) AN 174-7/**5952-7344**
- Measuring Phase Noise with the HP 3585A Spectrum Analyzer AN 246-2/**5952-8838**
- Modulation Domain Techniques for Measuring Complex Radar Signals AN 358-9/**5952-8003**
- Radar System Characterization and Testing Using the HP 5345A/55A/56A,B,C,D Counter AN 174-14/**5952-7892**
- Signal Generator Spectral Purity AN 388/**5952-2019**
- Understanding Frequency Counter Specifications AN 200-4/**5952-7522**
- Voltage Controlled Oscillators Characterization Using the HP 5350B, 5351B, 5352B CW Microwave Frequency Counter AN 181-2/**5952-7852**
- Frequency Modulation**  
Analyzing Phase-Locked Loop Transients in the Modulation Domain AN 358-7/**5952-8001**

- Characterizing Barker Coded Modulation in Radar Systems AN 358-10/5952-8004
- Characterizing Chirp Coded Modulation in Radar Systems AN 358-11/5952-8005
- Clock Rate Independent Jitter Measurements for Digital Communications Systems AN 358-5/5952-7999
- Fundamentals of Electronic Frequency Counters AN 200/5952-7506
- Modulation Domain Techniques for Measuring Complex Radar Signals AN 358-9/5952-8003
- Frequency Multiplication**
- External Frequency Doubling of the 8662A Synthesized Signal Generator AN 283-2/5952-8217
- Fundamentals of Electronic Frequency Counters AN 200/5952-7506
- Frequency Stability (Short-Term)**
- Clock Rate Independent Jitter Measurements for Digital Communications Systems AN 358-5/5952-7999
- Fundamentals of Electronic Frequency Counters AN 200/5952-7506
- High Speed Timing Acquisition and Statistical Jitter Analysis Using the HP 5370B Universal Time Interval Counter AN 191-7/5952-7908
- Measuring Fractional Frequency Standard Deviation (Sigma) Versus Averaging Time (TAU) AN 174-7/5952-7344
- Signal Generator Spectral Purity AN 388/5952-2019
- Simplify Frequency Stability Measurements With Built-in Allan Variance Analysis AN 358-12/5952-8006
- Voltage Controlled Oscillators Characterization Using the HP 5350B, 5351B, 5352B CW Microwave Frequency Counter AN 181-2/5952-7852
- Frequency Standards**
- Analyzing Phase-Locked Loop Transients in the Modulation Domain AN 358-7/5952-8001
- Clock Rate Independent Jitter Measurements for Digital Communications Systems AN 358-5/5952-7999
- Contribution of HP Clocks to the DII I's International Atomic Time Scale AN 52-4/5952-7855
- Crystal Testing with the 8640A/B and 8405A AN 171-1/5952-8117
- Measuring Fractional Frequency Standard Deviation (Sigma) Versus Averaging Time (TAU) AN 174-7/5952-7344
- Simplify Frequency Stability Measurements With Built-in Allan Variance Analysis AN 358-12/5952-8006
- Frequency Synthesizers**
- Analyzing Phase-Locked Loop Transients in the Modulation Domain AN 358-7/5952-8001
- External Frequency Doubling of the 8662A Synthesized Signal Generator AN 283-2/5952-8217
- Low Phase Noise Applications of the HP 8662A and 8663A Synthesized Signal Generators AN 283-3/5953-8435
- Millimeter Measurements Using the HP 3048A Phase Noise Measurement System AN 385/5951-6749
- Pre-Trigger Simplifies VCO Step Response Measurements AN 358-4/5952-7998
- Pulsed Carrier Phase Noise Measurements Using the HP 3048A Phase Noise Measurement System AN 386/5951-6743
- Signal Generator Spectral Purity AN 388/5952-2019
- Spectral Purity of Microwave Signal Sources AN 329/5954-8349
- Using the HP 5183T to Characterize Sonar Transducers and Systems AN 340-1/5952-7805
- Graphics**
- Line Quality and Accuracy - What They Are and How to Achieve Them AN 350-4/5954-7132
- Protocol Converters: Linking HP Graphics Peripherals with IBM Networks/Systems AN 229-11/5953-9874
- Using Your HP Plotter with an IBM Mainframe - For ISSCO Software Users AN 350-1/5954-7174
- Using Your Plotter with an IBM Mainframe - For SAS/Graph Software Users AN 350-3/5954-8748
- Using your Plotter or Printer with Peripheral Sharing Devices, Buffers, and Spoolers AN 350-6/5959-9713
- Group Delay**
- Floating Measurements and Guarding AN 123/5952-2153
- Fundamentals of Electronic Frequency Counters AN 200/5952-7506
- IC Testing**
- A Test Set-Up for Characterizing High-Speed Logic Devices AN 381/5953-6329
- High Speed Timing Acquisition and Statistical Jitter Analysis Using the HP 5370B Universal Time Interval Counter AN 191-7/5952-7908
- Role of DC Parametric Test in High Speed Digital and Microwave Component Manufacturing AN 339-20/5952-7936
- Impedance**
- Advanced TDR Techniques for use with the HP 54120 Family of Digitizing Oscilloscopes AN 62-3/5952-1141
- Analysis of Semiconductor Capacitance Characteristics Using the HP 4280A 1 MHz C Meter/C-V Plotter AN 322/5953-6939
- Characteristic Impedance Measurement of PC Board Circuit Patterns Using the HP 4194A Impedance/Gain-Phase Analyzer AN 339-2/5950-2908
- Constant Current Measurements Using the HP 4194A AN 339-8/5950-2923
- Dielectric Constant Measurement of Solid Materials AN 380-1/5950-2390
- Direct Radio Frequency Impedance Measurements Using the 4191A RF Impedance Analyzer AN 302-1/5952-8853
- Dynamic Component Test Using Vector Modulation Analysis AN 343-2/5954-6367
- Efficient Evaluation of LISNs and Voltage Probes for EME Tests Using the HP 4194A AN 339-7/5950-2922
- High Frequency Swept Measurements AN 183/5952-9200
- High Speed Measurement of Semiconductor Devices from Sub-PA to 1A AN 356/5950-2930
- Impedance Characterization of High Q Devices from 1 MHz to 1000 MHz with 1 Hz Resolution AN 302-2/5952-8872
- Impedance Characterization of Resonators Using the HP 4194A AN 339-1/5950-2882
- Impedance Measurement for Incoming Inspection — HP 4284A Applications Information AN 369-4/5950-2952
- Improving Time Domain Network Analysis Measurements AN 62-1/5954-2682
- Input/Output Impedance and Reflection Coefficient Measurements using the HP 4194A AN 339-10/5950-2925
- Magnetic Head Measurement Using a Constant Test Current — HP 4284A Application Information AN 369-3/5950-2951
- Measuring Cable Parameters AN 380-2/5950-2399
- Measuring the Characteristic Impedance of Balanced Cables Using the HP 4194A AN 339-4/5950-2918
- Measuring the Dielectric Constant of Solid Materials — HP 4194A Impedance/Gain-Phase Analyzer AN 339-13/5950-2935
- Negative Impedance Measurements of Crystal Oscillators Using the HP 4194A AN 339-9/5950-2924
- Parametric Analysis for Electronic Components and Circuit Evaluation Using the HP 4194A AN 339/5950-2856
- Practical Design and Evaluation of High Frequency Circuits Using the HP 4193A Vector Impedance Meter AN 317/5953-6910
- S-Parameter Design AN 154/5952-1087
- Static Head Testing for Disk Drives AN 339-6/5952-7871
- Static Head Testing for Disk Drives — HP 4194A Application Information AN 339-6/5952-7871
- Static Head Testing for Disk Drives - HP 4194A Application AN 339-6/5952-7871
- TDR Fundamentals for use with HP 54120T Digitizing Oscilloscope and TDR AN 62/5954-2681

# APPLICATION & PRODUCT NOTES

## Free Aids to Solving Your Test and Measurement Problems

### Application Notes

TDR Techniques for Differential Systems for use with the HP 54120 Family of Digitizing Oscilloscopes AN 62-2/5952-0154

Tantalum Capacitor Measurement — HP 4284A Application Information AN 369-2/5950-2950

Using Impedance Measurement to Evaluate Electronic Components and Materials — HP 4284A Application Information AN 369-1/5950-2949

Using the HP 5183T to Characterize Sonar Transducers and Systems AN 340-1/5952-7805

#### Insertion Gain/Loss

Advanced Filter Evaluation and Limit Testing with the HP 4195A AN 357-3/5950-2933

Amplifier Measurements Using the Scalar Network Analyzer AN 345-1/5954-1599

Fundamentals of RF and Microwave Noise Figure Measurement AN 57-1/5952-8255

High Frequency Swept Measurements AN 183/5952-9200

How to Measure Return Loss of Connectorized Optical Components AN 366-2/5952-9661

Network, Spectrum, and Impedance Evaluation of IF Circuits - HP 4195A Network/Spectrum Analyzer AN 357-1/5950-2931

Noise Figure Measurement Accuracy AN 57-2/5952-3706

S-Parameter Design AN 154/5952-1087

#### Jitter

Analyzing Phase-Locked Loop Transients in the Modulation Domain AN 358-7/5952-8001

Clock Rate Independent Jitter Measurements for Digital Communications Systems AN 358-5/5952-7999

Fundamentals of Electronic Frequency Counters AN 200/5952-7506

High Speed Timing Acquisition and Statistical Jitter Analysis Using the HP 5370B Universal Time Interval Counter AN 191-7/5952-7908

Jitter and Wander Analysis in Digital Communication with the HP 5371A Frequency and Time Interval Analyzer AN 358-2/5952-7925

Signal Generator Spectral Purity AN 388/5952-2019

Simplify Frequency Stability Measurements With Built-in Allan Variance Analysis AN 358-12/5952-8006

Time Domain Characterization of Magnetic Disc Drives AN 358-3/5952-7928

#### Lightwave

Bit Error Rate Measurements on Optical Fiber Systems AN 362/5952-9650

High Speed Timing Acquisition and Statistical Jitter Analysis Using the HP 5370B Universal Time Interval Counter AN 191-7/5952-7908

How to Measure Return Loss in Optical Links AN 366-3/5952-9662

How to Measure Return Loss of Connectorized Optical Components AN 366-2/5952-9661

Jitter and Wander Analysis in Digital Communication with the HP 5371A Frequency and Time Interval Analyzer AN 358-2/5952-7925

Lightwave Measurements with the HP 71400 Lightwave Signal Analyzer AN 371/5954-9137

#### Logic, Logic Test

A Manager's Guide to Signature Analysis AN 222-3/5952-7592

A Test Set-Up for Characterizing High-Speed Logic Devices AN 381/5953-6329

An Index to Signature Analysis Publications AN 222-0/5952-7625

Determining Digital Circuit Timing Tolerance to Optimize Adjustment or Design AN 191-2/5952-7488

Guidelines for Signature Analysis: Understanding the Signature Measurement AN 222-4/5952-7595

New Techniques of Digital Troubleshooting AN 163-2/5952-7558

Troubleshooting with Composite Signatures AN 222-6/5952-7684

#### Manufacturing

See *Production Test and Data Acquisition*

#### Materials Measurements

Canning Process Characterization AN 421-10/5954-9640

Explosion Testing AN 421-11/5954-9641

Materials Development AN 421-12/5954-9642

Paper Process Control AN 421-22/5954-9652

Rolling Mill AN 421-23/5954-9653

#### Measurement and Control

See *Data Acquisition*

#### Microprocessors

A Manager's Guide to Signature Analysis AN 222-3/5952-7592

An Index to Signature Analysis Publications AN 222-0/5952-7625

Guidelines for Signature Analysis: Understanding the Signature Measurement AN 222-4/5952-7595

Troubleshooting Microprocessor-based Systems Using the HP 5180A Waveform Recording (Using the HP 9825 Controller) AN 313-1/5952-7634

Troubleshooting with Composite Signatures AN 222-6/5952-7684

#### Microwave Component Measurements

Amplifier Measurements Using the Scalar Network Analyzer AN 345-1/5954-1599

Dynamic Component Test Using Vector Modulation Analysis AN 343-2/5954-6367

Voltage Controlled Oscillators Characterization Using the HP 5350B, 5351B, 5352B CW Microwave Frequency Counter AN 181-2/5952-7852

#### Microwaves

Accurate Mixer/Amplifier Compression Measurement Using the 8901A Modulation Analyzer AN 286-2/5952-8245

Advanced TDR Techniques for use with the HP 54120 Family of Digitizing Oscilloscopes AN 62-3/5952-1141

Applications and Operation of the 8901A Modulation Analyzer AN 286-1/5952-8208

Automated Characterization of Microwave Voltage Controlled Oscillators Using the HP 5361A Pulse/CW Microwave Counter AN 377-2/5952-7988

Automatic Frequency Profiling of Chirped Radar Pulses Using the HP 5361A Pulse/CW Microwave Counter AN 377-1/5952-7987

Characterization of Frequency Agile Sources with the HP 5371A Frequency and Time Interval Analyzer AN 358-1/5952-7924

Characterizing Barker Coded Modulation in Radar Systems AN 358-10/5952-8004

Characterizing Chirp Coded Modulation in Radar Systems AN 358-11/5952-8005

Configuration of a Two-tone Sweeping Generator AN 312-1/5952-9316

Digital Radio Testing with British Telecom AN 364-2/5952-1959

Direct Radio Frequency Impedance Measurements Using the 4191A RF Impedance Analyzer AN 302-1/5952-8853

Extending Dynamic Range of Scalar Transmission Measurements Using the HP 8757A, 8756A, or 8755C Scalar Network Analyzers AN 327-1/5953-8882

Frequency Profiling Without a Pulse Generator AN 377-3/5952-7991

Fundamentals of Electronic Frequency Counters AN 200/5952-7506

Fundamentals of Microwave Frequency Counters AN 200-1/5952-7484

Fundamentals of RF and Microwave Noise Figure Measurement AN 57-1/5952-8255

Fundamentals of RF and Microwave Power Measurement AN 64-1/5952-8178

High Frequency Swept Measurements AN 183/5952-9200

Improving Time Domain Network Analysis Measurements AN 62-1/5954-2682

Microwave Switching from SPDT to Full Access Matrix AN 332/5953-6466

Modulation Domain Techniques for Measuring Complex Radar Signals AN 358-9/5952-8003

Practical Strain Gauge Measurements AN 290-1/5952-8880

Pre-Trigger Simplifies VCO Step Response Measurements AN 358-4/5952-7998

Principles Of Microwave Connector Care AN 326/5954-1566



Quality Gains in Telecom Australia's Digital Microwave Network AN 364-1/5954-9572

Radar System Characterization and Testing Using the HP 5345A/55A/56A,B,C,D Counter AN 174-14/5952-7892

Role of DC Parametric Test in High Speed Digital and Microwave Component Manufacturing AN 339-20/5952-7936

S-Parameter Design AN 154/5952-1087

Spectral Purity of Microwave Signal Sources AN 329/5954-8349

Spectrum Analysis . . . AM and FM AN 150-1/5954-9130

Spectrum Analyzer Basics AN 150/5954-9130

TDR Fundamentals for Use with HP 54120T Digitizing Oscilloscope and TDR AN 62/5954-2681

TDR Techniques for Differential Systems for use with the HP 54120 Family of Digitizing Oscilloscopes AN 62-2/5952-0154

The 8640A/B Third Order Intermodulation Product Characteristics AN 170-2/5952-8129

User's Guide to the 5355/56 Automatic Frequency Converter AN 291-1/5952-7541

Voltage Controlled Oscillators Characterization Using the HP 5350B, 5351B, 5352B CW Microwave Frequency Counter AN 181-2/5952-7852

### Mixers

Accurate Mixer/Amplifier Compression Measurement Using the 8901A Modulation Analyzer AN 286-2/5952-8245

Configuration of a Two-tone Sweeping Generator AN 312-1/5952-9316

Fundamentals of RF and Microwave Noise Figure Measurement AN 57-1/5952-8255

Harmonic Distortion Measurements AN 378-1/5952-7253

Network, Spectrum, and Impedance Evaluation of IF Circuits - HP 4195A Network/Spectrum Analyzer AN 357-1/5950-2931

### Modulation

A Calibrated Signal Simulation System Utilizing I/Q Modulation Techniques AN 343-5/5952-6471

Accurate Mixer/Amplifier Compression Measurement Using the 8901A Modulation Analyzer AN 286-2/5952-8245

Analyzing Phase-Locked Loop Transients in the Modulation Domain AN 358-7/5952-8001

Applications and Operation of the 8901A Modulation Analyzer AN 286-1/5952-8208

Characterization of Frequency Agile Sources with the HP 5371A Frequency and Time Interval Analyzer AN 358-1/5952-7924

Characterizing Barker Coded Modulation in Radar Systems AN 358-10/5952-8004

Characterizing Chirp Coded Modulation in Radar Systems AN 358-11/5952-8005

Clock Rate Independent Jitter Measurements for Digital Communications Systems AN 358-5/5952-7999

Coherent Pulsed Tests of Radar and EW Systems AN 343-3/5954-6366

Digital Radio Testing with British Telecom AN 364-2/5952-1959

Digital Radio Theory and Measurements AN 355/5954-9554

Dynamic Component Test Using Vector Modulation Analysis AN 343-2/5954-6367

Exceptionally Complex Signal Simulation for Multi-Signal Environments in Radar/EW Test AN 314-4/5952-3702

Frequency Profiling Without a Pulse Generator AN 377-3/5952-7991

Jitter and Wander Analysis in Digital Communication with the HP 5371A Frequency and Time Interval Analyzer AN 358-2/5952-7925

Lightwave Measurements with the HP 71400 Lightwave Signal Analyzer AN 371/5954-9137

Measurements Applications for Digital Microwave Radio AN 343-1/5954-6365

Measuring Demodulator Image Rejection Using the HP 8980A Vector Analyzer AN 343-4/5952-3703

Measuring Microwave Radio Antenna Return Loss Using the HP 11758T Digital Radio Test System AN 379-2/5959-8749

Modulation Domain Techniques for Measuring Complex Radar Signals AN 358-9/5952-8003

Practical Strain Gauge Measurements AN 290-1/5952-8880

Quality Gains in Telecom Australia's Digital Microwave Network AN 364-1/5954-9572

Radar System Characterization and Testing Using the HP 5345A/55A/56A,B,C,D Counter AN 174-14/5952-7892

Simulating Sensor Signals AN 343-5/5952-6471

Spectrum Analysis . . . AM and FM AN 150-1/5954-9130

Using the HP 8980A Vector Analyzer AN 343-4/5952-3703

Voltage Controlled Oscillators Characterization Using the HP 5350B, 5351B, 5352B CW Microwave Frequency Counter AN 181-2/5952-7852

### Motion Control

Fundamentals of the z-Domain and Mixed Analog/Digital Measurements AN 243-4/5952-7250

Missile System Testing AN 421-19/5954-9649

Non-contact Measurements with Laser Interferometer AN 325-12/5952-8022

Sub-Micro Positioning with the HP 5527A Laser Position Transducer System AN 325-10/5952-7942

### Network Analysis

Advanced Filter Evaluation and Limit Testing with the HP 4195A AN 357-3/5950-2933

Advanced TDR Techniques for use with the HP 54120 Family of Digitizing Oscilloscopes AN 62-3/5952-1141

Amplifier Measurements Using the Scalar Network Analyzer AN 345-1/5954-1599

Complete S-Parameter and Distortion Measurement for Wide Band Video Amplifiers with the HP 4195A AN 357-2/5950-2932

Crystal Testing with the 8640A/B and 8405A AN 171-1/5952-8117

Direct Radio Frequency Impedance Measurements Using the 4191A RF Impedance Analyzer AN 302-1/5952-8853

Dynamic Component Test Using Vector Modulation Analysis AN 343-2/5954-6367

Improving Time Domain and Network Analysis Measurements AN 62-1/5952-2682

Log Sweep with the HP 3582A Spectrum Analyzer AN 245-5/5952-8805

Microwave Switching from SPDT to Full Access Matrix AN 332/5953-6466

Network, Spectrum, and Impedance Evaluation of IF Circuits — HP 4195A Network/Spectrum Analyzer AN 357-1/5950-2931

S-Parameter Design AN 154/5952-1087

TDR Fundamentals for use with the HP 54120 Digitizing Oscilloscope and TDR AN 62/5952-2681

TDR Techniques for Differential Systems for use with the HP 54120 Family of Digitizing Oscilloscopes AN 62-2/5952-0154

Testing Switching Power Supplies Using The HP 4194A AN 339-14/5950-2977

The Fundamentals of Signal Analysis AN 243/5952-8898

Using the HP 5183T to Characterize Sonar Transducers and Systems AN 340-1/5952-7805

### Noise

Clock Rate Independent Jitter Measurements for Digital Communications Systems AN 358-5/5952-7999

Digital Radio Testing with British Telecom AN 364-2/5952-1959

Fundamentals of RF and Microwave Noise Figure Measurement AN 57-1/5952-8255

Noise Figure Measurement Accuracy AN 57-2/5952-3706

Quality Gains in Telecom Australia's Digital Microwave Network AN 364-1/5954-9572

Signal Generator Spectral Purity AN 388/5952-2019

Simplify Frequency Stability Measurements With Built-in Allan Variance Analysis AN 358-12/5952-8006

Time Domain Characterization of Magnetic Disc Drives AN 358-3/5952-7928

# APPLICATION & PRODUCT NOTES

## Free Aids to Solving Your Test and Measurement Problems

### Application Notes

Using the HP 5183T to Characterize Sonar Transducers and Systems  
AN 340-1/5952-7805

#### Oscillators

Applications and Operation of the 8901A Modulation Analyzer AN 286-1/5952-8208

Automated Characterization of Microwave Voltage Controlled Oscillators Using the HP 5361A Pulse/CW Microwave Counter  
AN 377-2/5952-7988

Fundamentals of Quartz Oscillators  
AN 200-2/5952-7507

Harmonic Distortion Measurements  
AN 378-1/5952-7253

Measuring Fractional Frequency Standard Deviation (Sigma) Versus Averaging Time (TAU)  
AN 174-7/5952-7344

Measuring Warm-Up Characteristics and Aging Rates of Oscillators  
AN 174-11/5952-7327

Network, Spectrum, and Impedance Evaluation of IF Circuits - HP 4195A Network/Spectrum Analyzer  
AN 357-1/5950-2931

Pre-Trigger Simplifies VCO Step Response Measurements  
AN 358-4/5952-7998

Simplify Frequency Stability Measurements With Built-in Allan Variance Analysis  
AN 358-12/5952-8006

Spectral Purity of Microwave Signal Sources  
AN 329/5954-8349

The Fundamentals of Electronic Frequency Counters  
AN 200/5952-7506

Using the HP 5180A Waveform Recorder to Measure Microwave VCO Settling Time and Post Tuning Drift  
AN 313-3/5952-7636

#### Oscilloscopes

Advanced TDR Techniques for use with the HP 54120 Family of Digitizing Oscilloscopes  
AN 62-3/5952-1141

Bandwidth and Sampling Rate in Digitizing Oscilloscopes  
AN 344/5954-2631

Extending the Frequency Range and Increasing the Effective Sample Rate of the HP 5180A Waveform Recorder  
AN 313-4/5952-7637

Interconnecting Two or More HP 5180A Waveform Recorders to Obtain Multiple Input Channels  
AN 313-7/5952-7670

TDR Fundamentals for Use with HP 54120T Digitizing Oscilloscope and TDR  
AN 62/5954-2681

TDR Techniques for Differential Systems for use with the HP 54120 Family of Digitizing Oscilloscopes  
AN 62-2/5952-0154

Using the Direct Memory Access Capability of the HP 5180A Waveform Recorder with the HP 9826 Desktop Computer  
AN 313-8/5952-7710

Voltage and Time Resolution in Digitizing Oscilloscopes  
AN 348/5954-2652

#### Phase Linearity

Analyzing Phase-Locked Loop Transients in the Modulation Domain  
AN 358-7/5952-8001

Characterizing Barker Coded Modulation in Radar Systems  
AN 358-10/5952-8004

Characterizing Chirp Coded Modulation in Radar Systems  
AN 358-11/5952-8005

Complete S-Parameter and Distortion Measurement for Wide Band Video Amplifiers with the HP 4195A  
AN 357-2/5950-2932

Direct Radio Frequency Impedance Measurements Using the 4191A RF Impedance Analyzer  
AN 302-1/5952-8853

The Fundamentals of Electronic Frequency Counters  
AN 200/5952-7506

Voltage Controlled Oscillators Characterization Using the HP 5350B, 5351B, 5352B CW Microwave Frequency Counter  
AN 181-2/5952-7852

#### Phase Modulation

Analyzing Phase-Locked Loop Transients in the Modulation Domain  
AN 358-7/5952-8001

Characterizing Barker Coded Modulation in Radar Systems  
AN 358-10/5952-8004

Characterizing Chirp Coded Modulation in Radar Systems  
AN 358-11/5952-8005

Clock Rate Independent Jitter Measurements for Digital Communications Systems  
AN 358-5/5952-7999

Fundamentals of Electronic Frequency Counters  
AN 200/5952-7506

Single-Shot BPSK Signal Characterization  
AN 358-8/5952-8002

#### Phase Shift

Analyzing Phase-Locked Loop Transients in the Modulation Domain  
AN 358-7/5952-8001

Characterizing Barker Coded Modulation in Radar Systems  
AN 358-10/5952-8004

Characterizing Chirp Coded Modulation in Radar Systems  
AN 358-11/5952-8005

Clock Rate Independent Jitter Measurements for Digital Communications Systems  
AN 358-5/5952-7999

Crystal Testing with the 8640A/B and 8405A  
AN 171-1/5952-8117

Fundamentals of Electronic Frequency Counters  
AN 200/5952-7506

Jitter and Wander Analysis in Digital Communication with the HP 5371A Frequency and Time Interval Analyzer  
AN 358-2/5952-7925

Using the HP 5183T to Characterize Sonar Transducers and Systems  
AN 340-1/5952-7805

#### Phase Stability

Analyzing Phase-Locked Loop Transients in the Modulation Domain  
AN 358-7/5952-8001

Characterizing Barker Coded Modulation in Radar Systems  
AN 358-10/5952-8004

Characterizing Chirp Coded Modulation in Radar Systems  
AN 358-11/5952-8005

Clock Rate Independent Jitter Measurements for Digital Communications Systems  
AN 358-5/5952-7999

Communications Cable Testing  
AN 421-8/5954-9638

Jitter and Wander Analysis in Digital Communication with the HP 5371A Frequency and Time Interval Analyzer  
AN 358-2/5952-7925

Simplify Frequency Stability Measurements With Built-in Allan Variance Analysis  
AN 358-12/5952-8006

#### Power Measurement

Battery Testing  
AN 372-2/5952-4191

Biasing Three-Terminal Devices for Test  
AN 376-1/5952-4193

Fundamentals of RF and Microwave Power Measurement  
AN 64-1/5952-8178

High Frequency Swept Measurements  
AN 183/5952-9200

Power Supply Testing  
AN 372-1/5952-4190

#### Power Supplies

Battery Charging/Discharging  
AN 250-2/5952-4033

DC Power Supply Handbook  
AN 90B/5952-4020

Power Supply Testing with the HP 5180A Waveform Recorder  
AN 313-5/5952-7647

Power Supply Testing  
AN 372-1/5952-4190

#### Process Control

Canning Process Characterization  
AN 421-10/5954-9640

Environmental/Autoclave Testing  
AN 421-7/5954-9637

Machine Monitoring and Control  
AN 421-20/5954-9650

Materials Development  
AN 421-12/5954-9642

Monitoring of Ultrasonic Wire Bonding Machines  
AN 393/5952-2143

Paper Process Control  
AN 421-22/5954-9652

Pharmaceutical Process Control  
AN 421-21/5954-9651

Pilot Plant monitoring  
AN 421-15/5954-9645

Plating Line Control  
AN 421-13/5954-9643

Role of DC Parametric Test in High Speed Digital and Microwave Component Manufacturing  
AN 339-20/5952-7936

Rolling Mill  
AN 421-23/5954-9653

Using the HP 3497A to Control Industrial Wastewater Treatment  
AN 290-2/5953-6921

Waste Water Treatment  
AN 421-4/5954-9634

#### Production Test

Accessing the HP 3582A Memory with HP-IB  
AN 245-4/5952-8804

Appliance Testing  
AN 421-24/5954-9654

Battery Testing AN 421-14/5954-9644  
 Battery Testing AN 372-2/5952-4191  
 Biasing Three-Terminal Devices for Test AN 376-1/5952-4193  
 Disk Drive Servo-Track Writing with Laser Interferometers AN 325-11/5952-7984  
 Environmental/Autoclave Testing AN 421-7/5954-9637  
 Fan Testing AN 421-2/5954-9632  
 Fundamentals of Electronic Frequency Counters AN 200/5952-7506  
 Harmonic Distortion Measurements AN 378-1/5952-7253  
 Internal Combustion Engine Testing AN 421-6/5954-9636  
 Jet Engine Controller Testing AN 421-5/5954-9635  
 Jet Engine Testing AN 421-16/5954-9646  
 Large Product Characterization AN 421-18/5954-9648  
 Missile System Testing AN 421-19/5954-9649  
 Monitoring of Ultrasonic Wire Bonding Machines AN 393/5952-2143  
 Parametric Analysis for Electronic Components and Circuit Evaluation Using the HP 4194A AN 339/5950-2856  
 Power Supply Testing AN 372-1/5952-4190  
 Practical Strain Gauge Measurements AN 290-1/5952-8880  
 Reducing Fixture-Induced Test Failures AN 340-1/5952-7805  
 Role of DC Parametric Test in High Speed Digital and Microwave Component Manufacturing AN 339-20/5952-7936  
 Understanding Your Test Fixture AN 324-1/5953-6951  
 Using the HP 5183T to Characterize Sonar Transducers and Systems AN 340-1/5952-7805

**Protocol Analysis**  
 Keeping Your Big Blue Network in the Pink AN 424/5952-5131  
 The Care and Feeding of Your X-25 Network AN 425/5952-5132

**Pulse Measurements, Modulation**  
 Analyzing Phase-Locked Loop Transients in the Modulation Domain AN 358-7/5952-8001  
 Automatic Frequency Profiling of Chirped Radar Pulses Using the HP 5361A Pulse/CW Microwave Counter AN 377-1/5952-7987  
 Characterization of Frequency Agile Sources with the HP 5371A Frequency and Time Interval Analyzer AN 358-1/5952-7924  
 Characterizing Barker Coded Modulation in Radar Systems AN 358-10/5952-8004  
 Characterizing Chirp Coded Modulation in Radar Systems AN 358-11/5952-8005

Characterizing Transient Timing Errors in Disk and Tape Drives AN 358-6/5952-8000  
 Dynamic Component Test Using Vector Modulation Analysis AN 343-2/5954-6367  
 Frequency Profiling Without a Pulse Generator AN 377-3/5952-7991  
 Modulation Domain Techniques for Measuring Complex Radar Signals AN 358-9/5952-8003  
 Radar System Characterization and Testing Using the HP 5345A/55A/56A,B,C,D Counter AN 174-14/5952-7892  
 Recording Sonar and Other Signals Using the HP 5180A's Toggle Mode AN 313-6/5952-7641  
 The Fundamentals of Electronic Frequency Counters AN 200/5952-7506  
 Using the 5180A Waveform Recorder to Evaluate Floppy Disc Media and Drive Electronics AN 313-9/5952-7701

**RFI Testing**  
 Automatic CISPR EMI Testing for Conducted Emissions AN 331-1/5954-2724  
 Automatic MIL-STD EMI Testing Using the HP 85864A/B EMI Measurement Software AN 330-1/5954-2705

**Radar**  
 Amplifier Measurements Using the Scalar Network Analyzer AN 345-1/5954-1599  
 Analyzing Phase-Locked Loop Transients in the Modulation Domain AN 358-7/5952-8001  
 Automatic Frequency Profiling of Chirped Radar Pulses Using the HP 5361A Pulse/CW Microwave Counter AN 377-1/5952-7987  
 Characterization of Frequency Agile Sources with the HP 5371A Frequency and Time Interval Analyzer AN 358-1/5952-7924  
 Characterizing Barker Coded Modulation in Radar Systems AN 358-10/5952-8004  
 Characterizing Chirp Coded Modulation in Radar Systems AN 358-11/5952-8005  
 Coherent Pulsed Tests of Radar and EW Systems AN 343-3/5954-6366  
 Dynamic Component Test Using Vector Modulation Analysis AN 343-2/5954-6367  
 Exceptionally Complex Signal Simulation for Multi-Signal Environments in Radar/EW Test AN 314-4/5952-3702  
 Frequency Profiling Without a Pulse Generator AN 377-3/5952-7991  
 Low Phase Noise Applications of the HP 8662A and 8663A Synthesized Signal Generators AN 283-3/5953-8435  
 Microwave Switching from SPDT to Full Access Matrix AN 332/5953-6466  
 Millimeter Measurements Using the HP 3048A Phase Noise Measurement System AN 385/5951-6749  
 Modulation Domain Techniques for Measuring Complex Radar Signals AN 358-9/5952-8003

Pre-Trigger Simplifies VCO Step Response Measurements AN 358-4/5952-7998  
 Pulsed Carrier Phase Noise Measurements Using the HP 3048A Phase Noise Measurement System AN 386/5951-6743  
 Radar System Characterization and Testing Using the HP 5345A/55A/56A,B,C,D Counter AN 174-14/5952-7892  
 Single Shot BPSK Signal Characterization AN 358-8/5952-8002  
 The Fundamentals of Electronic Frequency Counters AN 200/5952-7506  
 User's Guide to the 5355/56 Automatic Frequency Converter AN 291-1/5952-7541  
 Voltage Controlled Oscillators Characterization Using the HP 5350B, 5351B, 5352B CW Microwave Frequency Counter AN 181-2/5952-7852

### Receivers

Configuration of a Two-tone Sweeping Generator AN 312-1/5952-9316  
 Exceptionally Complex Signal Simulation for Multi-Signal Environments in Radar/EW Test AN 314-4/5952-3702  
 Fundamentals of RF and Microwave Noise Figure Measurement AN 57-1/5952-8255  
 HP 8640A/B Signal Generator Output Level Accuracy AN 170-1/5952-1218  
 Measurements Applications for Digital Microwave Radio AN 343-1/5954-6365  
 Measuring Demodulator Image Rejection Using the HP 8980A Vector Analyzer AN 343-4/5952-3703  
 Measuring Microwave Radio Antenna Return Loss Using the HP 11758T Digital Radio Test System AN 379-2/5959-8749  
 Signal Generator Spectral Purity AN 388/5952-2019  
 The 8640A/B Third Order Intermodulation Product Characteristics AN 170-2/5952-8129

### Reflectometers

Advanced TDR Techniques for use with the HP 54120 Family of Digitizing Oscilloscopes AN 62-3/5952-1141  
 High Frequency Swept Measurements AN 183/5952-9200  
 How to Measure Return Loss of Connectorized Optical Components AN 366-2/5952-9661  
 Improving Time Domain and Network Analysis Measurements AN 62-1/5952-2682  
 S-Parameter Design AN 154/5952-1087  
 TDR Fundamentals for use with the HP 54120 Digitizing Oscilloscope and TDR AN 62/5952-2681  
 TDR Techniques for Differential Systems for use with the HP 54120 Family of Digitizing Oscilloscopes AN 62-2/5952-0154

### S-Parameters

Complete S-Parameter and Distortion Measurement for Wide Band Video Amplifiers with the HP 4195A AN 357-2/5950-2932

# APPLICATION & PRODUCT NOTES

## Free Aids to Solving Your Test and Measurement Problems

### Application Notes

S-Parameter Design AN 154/5952-1087

S-Parameter Techniques for Faster, More Accurate Network Design AN 95-1/5952-1130

#### Semiconductors

Analysis of Semiconductor Capacitance Characteristics Using the HP 4280A 1 MHz C Meter/C-V Plotter AN 322/5953-6939

Automation of Semiconductor Parameter Analysis AN 334/5952-7765

High-Speed DC Characterization of Semiconductor Devices from Sub pA to 1A AN 356-1/5950-2930

Monitoring of Ultrasonic Wire Bonding Machines AN 393/5952-2143

Multi-frequency C-V Measurements and Doping Profile Analysis of Semiconductors Using the HP 4194A AN 339-5/5950-2919

Multi-frequency C-V Measurements of Semiconductors — HP 4284A Application Information AN 369-5/5950-2953

Role of DC Parametric Test in High Speed Digital and Microwave Component Manufacturing AN 339-20/5952-7936

Semiconductor Measurements with the HP 4140B Picoammeter/DC Voltage Source AN 238/5952-8840

Sub-Micro Positioning with the HP 5527A Laser Position Transducer System AN 325-10/5952-7942

Techniques and Applications for High Throughput and Stable Characterization AN 356-1/5950-2954

Ultra Low Current Semiconductor DC Parameter Measurement System Using HP 4140B AN 238-1/5952-8873

#### Signal Sources

Configuration of a Two-tone Sweeping Generator AN 312-1/5952-9316

Crystal Testing with the 8640A/B and 8405A AN 171-1/5952-8117

Exceptionally Complex Signal Simulation for Multi-Signal Environments in Radar/EW Test AN 314-4/5952-3702

External Frequency Doubling of the 8662A Synthesized Signal Generator AN 283-2/5952-8217

HP 8640A/B Signal Generator Output Level Accuracy AN 170-1/5952-1218

Low Phase Noise Applications of the HP 8662A and 8663A Synthesized Signal Generators AN 283-3/5953-8435

Millimeter Measurements Using the HP 3048A Phase Noise Measurement System AN 385/5951-6749

Obtaining Leveled Pulse-Modulated Microwave Signals from the HP 8672A AN 218-5/5952-8251

Obtaining Millihertz Resolution from the 8671A and 8672A AN 218-2/5952-8184

Pre-Trigger Simplifies VCO Step Response Measurements AN 358-4/5952-7998

Pulsed Carrier Phase Noise Measurements Using the HP 3048A Phase Noise Measurement System AN 386/5951-6743

The 8640A/B Third Order Intermodulation Product Characteristics AN 170-2/5952-8129

Using the HP 5183T to Characterize Sonar Transducers and Systems AN 340-1/5952-7805

#### Signature Analysis

A Manager's Guide to Signature Analysis AN 222-3/5952-7592

An Index to Signature Analysis Publications AN 222-0/5952-7625

Guidelines for Signature Analysis: Understanding the Signature Measurement AN 222-4/5952-7595

Troubleshooting with Composite Signatures AN 222-6/5952-7684

#### Smith Chart

S-Parameter Design AN 154/5952-1087

S-Parameter Techniques for Faster, More Accurate Network Design AN 95-1/5952-1130

#### Spectrum Analysis

Accessing the HP 3582A Memory with HP-IB AN 245-4/5952-8804

Complete S-Parameter and Distortion Measurement for Wide Band Video Amplifiers with the HP 4195A AN 357-2/5950-2932

Effective Machinery Maintenance Using Vibration Analysis AN 243-1/5953-5113

Fundamentals of Modal Testing AN 243-3/5954-7957

Fundamentals of Signal Analysis AN 243/5952-8898

Harmonic Distortion Measurements AN 378-1/5952-7253

Log Sweep with the HP 3582A Spectrum Analyzer AN 245-5/5952-8805

Measuring Phase Noise with the HP 3585A Spectrum Analyzer AN 246-2/5952-8838

Network, Spectrum, and Impedance Evaluation of IF Circuits - HP 4195A Network/Spectrum Analyzer AN 357-1/5950-2931

Non-contact Measurements with Laser Interferometer AN 325-12/5952-8022

Optimizing the Dynamic Range of the HP 3585A Spectrum Analyzer AN 246-1/5952-8815

Recording Sonar and Other Signals Using the HP 5180A's Toggle Mode AN 313-6/5952-7641

Spectrum Analysis . . . AM and FM AN 150-1/5954-9130

Spectrum Analyzer Basics AN 150/5952-0292

Using the HP 3585A Spectrum Analyzer with the HP 9825A Computing Controller AN 246/5952-8765

Using the HP 5180A Waveform Recorder with a Spectrum Analyzer for New Time-Domain Measurement Capability AN 313-2/5952-7635

#### Stripline Device Measurements

Advanced TDR Techniques for use with the HP 54120 Family of Digitizing Oscilloscopes AN 62-3/5952-1141

TDR Fundamentals for use with HP 54120T Digitizing Oscilloscope and TDR AN 62/5954-2681

TDR Techniques for Differential Systems for use with the HP 54120 Family of Digitizing Oscilloscopes AN 62-2/5952-0154

#### Swept-Frequency Measurements

Amplifier Measurements Using the Scalar Network Analyzer AN 345-1/5954-1599

Analyzing Phase-Locked Loop Transients in the Modulation Domain AN 358-7/5952-8001

Characterizing Barker Coded Modulation in Radar Systems AN 358-10/5952-8004

Characterizing Chirp Coded Modulation in Radar Systems AN 358-11/5952-8005

Configuration of a Two-tone Sweeping Generator AN 312-1/5952-9316

Extending Dynamic Range of Scalar Transmission Measurements Using the HP 8757A, 8756A, or 8755C Scalar Network Analyzers AN 327-1/5953-8882

Harmonic Distortion Measurements AN 378-1/5952-7253

How to Measure Return Loss of Connectorized Optical Components AN 366-2/5952-9661

Low Phase Noise Applications of the HP 8662A and 8663A Synthesized Signal Generators AN 283-3/5953-8435

Millimeter Measurements Using the HP 3048A Phase Noise Measurement System AN 385/5951-6749

Modulation Domain Techniques for Measuring Complex Radar Signals AN 358-9/5952-8003

Optimizing the Dynamic Range of the HP 3585A Spectrum Analyzer AN 246-1/5952-8815

Pulsed Carrier Phase Noise Measurements Using the HP 3048A Phase Noise Measurement System AN 386/5951-6743

Spectral Purity of Microwave Signal Sources AN 329/5954-8349

Spectrum Analyzer Basics AN 150/5952-1213

Using the HP 5183T to Characterize Sonar Transducers and Systems AN 340-1/5952-7805

#### Switching

Analyzing Phase-Locked Loop Transients in the Modulation Domain AN 358-7/5952-8001

Data Acquisition and Computer Aided Test Application Notes for 32 Industries in Series AN 421-1/5954-9631

Missile System Testing AN 421-19/5954-9649

Novel Combinations of Microwave Switches and Step Attenuators for Programming Applications AN 332-1/5953-8892

Practical Test System Signal Switching AN 328-1/5953-6962

Pre-Trigger Simplifies VCO Step Response Measurements AN 358-4/5952-7998

### Synthesizers/Signal Generators

Analyzing Phase-Locked Loop Transients in the Modulation Domain AN 358-7/5952-8001

Exceptionally Complex Signal Simulation for Multi-Signal Environments in Radar/EW Test AN 314-4/5952-3702

External Frequency Doubling of the 8662A Synthesized Signal Generator AN 283-2/5952-8217

Low Phase Noise Applications of the HP 8662A and 8663A Synthesized Signal Generators AN 283-3/5953-8435

Millimeter Measurements Using the HP 3048A Phase Noise Measurement System AN 385/5951-6749

Pulsed Carrier Phase Noise Measurements Using the HP 3048A Phase Noise Measurement System AN 386/5951-6743

Rotation Simulation and ADC Testing with Synthesized Signals AN 373/5952-9693

Signal Generator Spectral Purity AN 388/5952-2019

Spectral Purity of Microwave Signal Sources AN 329/5954-8349

### Telecommunications

Amplifier Measurements Using the Scalar Network Analyzer AN 345-1/5954-1599

Analyzing Phase-Locked Loop Transients in the Modulation Domain AN 358-7/5952-8001

Clock Rate Independent Jitter Measurements for Digital Communications Systems AN 358-5/5952-7999

Digital Radio Testing with British Telecom AN 361-2/5952-1959

Digital Radio Theory and Measurements AN 355/5954-9554

Exceptionally Complex Signal Simulation for Multi-Signal Environments in Radar/EW Test AN 314-4/5952-3702

Fundamentals of Electronic Frequency Counters AN 200/5952-7506

High Speed Measurement of Semiconductor Devices from Sub-PA to 1A AN 356/5950-2930

High Speed Timing Acquisition and Statistical Jitter Analysis Using the HP 5370B Universal Time Interval Counter AN 191-7/5952-7908

How to Measure Return Loss of Connectorized Optical Components AN 366-2/5952-9661

ISDN 23B&D PAR and DMI Testing Using the HP 3787B and Protocol Analyzer AN 368/5959-8215

Measurements Applications for Digital Microwave Radio AN 343-1/5954-6365

Measuring Microwave Radio Antenna Return Loss Using the HP 11758T Digital Radio Test System AN 379-2/5959-8749

Quality Gains in Telecom Australia's Digital Microwave Network AN 364-1/5954-9572

The Benefits of P/AR AN 318-1/5952-4996D

### Temperature Measurement

Appliance Testing AN 421-24/5954-9654

Battery Testing AN 421-14/5954-9644

Communications Cable Testing AN 421-8/5954-9638

Environmental/Autoclave Testing AN 421-7/5954-9637

Explosion Testing AN 421-11/5954-9641

Facility Management AN 421-17/5954-9647

Internal Combustion Engine Testing AN 421-6/5954-9636

Jet Engine Controller Testing AN 421-5/5954-9635

Jet Engine Testing AN 421-16/5954-9646

Large Product Characterization AN 421-18/5954-9648

Machine Monitoring and Control AN 421-20/5954-9650

Materials Development AN 421-12/5954-9642

Missile System Testing AN 421-19/5954-9649

Paper Process Control AN 421-22/5954-9652

Pharmaceutical Process Control AN 421-21/5954-9651

Pilot Plant Monitoring AN 421-15/5954-9645

Residential Facility Monitoring AN 421-9/5954-9639

Rolling Mill AN 421-23/5954-9653

Waste Water Treatment AN 421-4/5954-9634

### Throughput Analysis

High Speed Timing Acquisition and Statistical Jitter Analysis Using the HP 5370B Universal Time Interval Counter AN 191-7/5952-7908

Machine Tool Calibration Using the HP 5528A Laser Measurement System AN 325-2/5952-7708

### Time-Interval, Timing Analysis

Analyzing Phase-Locked Loop Transients in the Modulation Domain AN 358-7/5952-8001

Characterizing Barker Coded Modulation in Radar Systems AN 358-10/5952-8004

Characterizing Chirp Coded Modulation in Radar Systems AN 358-11/5952-8005

Characterizing Transient Timing Errors in Disk and Tape Drives AN 358-6/5952-8000

Clock Rate Independent Jitter Measurements for Digital Communications Systems AN 358-5/5952-7999

Determining Digital Circuit Timing Tolerance to Optimize Adjustment or Design AN 191-2/5952-7488

Modulation Domain Techniques for Measuring Complex Radar Signals AN 358-9/5952-8003

Pre-Trigger Simplifies VCO Step Response Measurements AN 358-4/5952-7998

Radar System Characterization and Testing Using the HP 5345A/55A/56A,B,C,D Counter AN 174-14/5952-7892

The Fundamentals of Electronic Frequency Counters AN 200/5952-7506

Time Domain Characterization of Magnetic Disc Drives AN 358-3/5952-7928

Time Interval Measurement Using an Electronic Counter AN 200-3/5952-7561

Understanding Frequency Counter Specifications AN 200-4/5952-7522

Using the HP 5180A Waveform Recorder with a Spectrum Analyzer for New Time-Domain Measurement Capability AN 313-2/5952-7635

### Transistor Parameters

Automation of Semiconductor Parameter Analysis AN 334/5952-7765

Biasing Three-Terminal Devices for Test AN 376-1/5952-4193

Fundamentals of RF and Microwave Noise Figure Measurement AN 57-1/5952-8255

Role of DC Parametric Test in High Speed Digital and Microwave Component Manufacturing AN 339-20/5952-7936

S-Parameter Techniques for Faster, More Accurate Network Design AN 95-1/5952-1130

### Transmission Lines

Advanced TDR Techniques for use with the HP 54120 Family of Digitizing Oscilloscopes AN 62-3/5952-1141

Improving Time Domain Network Analysis Measurements AN 62-1/5954-2682

TDR Fundamentals for use with HP 54120T Digitizing Oscilloscope and TDR AN 62/5954-2681

TDR Techniques for Differential Systems for use with the HP 54120 Family of Digitizing Oscilloscopes AN 62-2/5952-0154

### Troubleshooting

A Manager's Guide to Signature Analysis AN 222-3/5952-7592

Advanced TDR Techniques for use with the HP 54120 Family of Digitizing Oscilloscopes AN 62-3/5952-1141

An Index to Signature Analysis Publications AN 222-0/5952-7625

Analyzing Phase-Locked Loop Transients in Modulation Domain AN 358-7/5952-8001

Clock Rate Independent Jitter Measurements for Digital Communications Systems AN 358-5/5952-7999

# APPLICATION & PRODUCT NOTES

## Free Aids to Solving Your Test and Measurement Problems

### Application Notes & Product Notes

Determining Digital Circuit Timing Tolerance to Optimize Adjustment or Design  
AN 191-2/5952-7488

Fundamentals of Electronic Frequency Counters  
AN 200/5952-7506

Guidelines for Signature Analysis: Understanding the Signature Measurement  
AN 222-4/5952-7595

Improving Time Domain and Network Analysis Measurements  
AN 62-1/5952-2682

ISDN 23B&D PAR and DMI Testing Using the HP 3787B and Protocol Analyzer  
AN 368/5959-8215

Jitter and Wander Analysis in Digital Communication with the HP 5371A Frequency and Time Interval Analyzer  
AN 358-2/5952-7925

New Techniques of Digital Troubleshooting  
AN 163-2/5952-7558

Principles Of Microwave Connector Care  
AN 326/5954-1566

Reducing Fixture-induced Test Failures  
AN 340-1/5952-7805

TDR Fundamentals for use with the HP 54120 Digitizing Oscilloscope and TDR  
AN 62/5952-2681

TDR Techniques for Differential Systems for use with the HP 54120 Family of Digitizing Oscilloscopes  
AN 62-2/5952-0154

Troubleshooting with Composite Signatures  
AN 222-6/5952-7684

Understanding Your Test Fixture  
AN 324-1/5953-6951

#### Vector Measurements

Digital Radio Testing with British Telecom  
AN 364-2/5952-1959

HP 8640A/B Signal Generator Output Level Accuracy  
AN 170-1/5952-1218

Quality Gains in Telecom Australia's Digital Microwave Network  
AN 364-1/5954-9572

S-Parameter Design  
AN 154/5952-1087

S-Parameter Techniques for Faster, More Accurate Network Design  
AN 95-1/5952-1130

#### Voltage-Controlled Oscillator

Analyzing Phase-Locked Loop Transients in Modulation Domain  
AN 358-7/5952-8001

Measuring Warm-Up Characteristics and Aging Rates of Oscillators  
AN 174-11/5952-7327

Pre-Trigger Simplifies VCO Step Response Measurements  
AN 358-4/5952-7998

Using the HP 5180A Waveform Recorder to Measure Microwave VCO Settling Time and Post Tuning Drift  
AN 313-3/5952-7636

#### Wave Analysis

Bandwidth and Sampling Rate in Digitizing Oscilloscopes  
AN 344/5954-2631

Voltage and Time Resolution in Digitizing Oscilloscopes  
AN 348/5954-2652

#### Product Notes

3065-4/5954-8670—Fixturing for High-speed Integrity on the HP 3065 at Combinational Test System

3235-1/5953-7023—Programming Guide to the HP 3235A Switch/ Test Unit and the HP System 1000

3314A-1/5953-5102—Operator's Introduction to the HP 3314A

3324A/5952-9693—Rotation Simulation and ADC Testing with Synthesized Signals Using the HP 3324A

3325B-1/5954-7987—Remote Operation of the HP 3325B via RS232

3326A-1/5953-5134—Introductory Operating Guide to the HP 3326A Two-channel Synthesizer

3458-1/5953-7058—Optimizing Throughput and Reading Rate

3458-2/5953-7059—High Resolution Digitizing with the HP 3458A

3458-3/5953-7060—Electronic Calibration of the HP 3458A

3488A-1/5953-6959—Using the HP 3488A

3561A-1/5953-5114—Using the HP 3561A Dynamic Signal Analyzer

3561A-2/5952-4819—Acoustic Measurements with the HP 3561A

3561A/5953-5186—HP-IB Programming Commands for the HP 3561A Dynamic Signal Analyzer

3562A-1/5954-7973—Operator's Introduction to the HP 3562A Dynamic Signal Analyzer

3562A-2/5953-5191—Signal Switching and Multi-channel Measurements with the HP 3562A Dynamic Signal Analyzer

3562A-3/5952-0001—Curvefitting in the HP 3562A-3

3562A-4/5952-8070—Measuring Nonlinear Distortion Using the HP 3562A DSA

3562A/3563A-1/5952-1437—Measuring of the Open-Loop Frequency of the Phase-Locked Loop

3562A/35660A-1/5952-0002—PC Control of the HP 3566A & HP 3562A DSA via HP-IB

3563A-1/5952-7251—Z-Domain Curvefitting in the 3563A

3577A-1/5953-5119—User's Guide to the HP 3577A Network Analyzer

3577A-2/5953-5131—Loop Gain Measurements with the HP 3577A Network Analyzer

3577B-1/5952-2141—Measuring the Open-Loop Frequency Response of the Phase-Locked Loop

3588A-1/5952-2145—Measurement Automation with HP Instrument BASIC

3708-1/5953-5487—Noise and Interference Effects in Microwave Radio Systems

3708-3/5953-5490—Determination of Residual Bit-Error Ratio in Digital Microwave Systems

3708-4/5954-9551—Demonstration Guide: How to Win with the HP 3708A

3730-1/5953-5468—High Accuracy RF Measurements Using the HP 3730B

3776-1/5953-5440—Measurement Principles

3776-5/5953-5463—Simulation of Line Signaling and Dialing with the HP 3776A

3785-1/5953-5429—Practical Jitter Measurements

3852-1/5953-7011—Programming Guide to the HP 3852A and the HP 1000

3852-3/5953-7043—Multitasking on the HP 3852A Data Acquisition/Control Unit

4935A-1/5952-4988—Datacom Channel Testing with an HP 4935A

4948A-1/5954-7913—Measurement Principles

4954A-1/5952-5138—SNA Network Performance Analysis

4954A-2/5952-5120—X.25 Network Performance Analysis

5180A-3/5952-7643—General Purpose Subroutines for HP 5180A Waveform Recorders

5182A-1/5952-7733—Understanding the HP 5182A Waveform Recorder/Generator

5335A/5952-7604—HP 5335A Universal Counter User's Introduction

5370B-2/5952-7834—Better than 100 ps Accuracy in HP 5370B Time Interval Measurements

5370B-3/5952-7769—High Throughput Picosecond Characterization of Pulse Parameters

5371A/5952-7959—HP 5371A Frequency and Time Interval Analyzer

5527A-1/5952-7947—Rapid Data Collection with the HP 5527A Laser Position Transducer System

5527A-2/5952-7973—Achieving Maximum Accuracy and Repeatability with the HP 5527A Laser Position Transducer System

5527A/B-3/5952-8020—Advanced Measurement Techniques Using the HP5527A/B Laser Position Transducer System

8340-2/5954-1595—Generating Phase-Coherent Microwave Signals with the HP 8340 and 8341 Synthesized Sweepers

8340-3/5954-8389—Typical Performance of 8340 and 8341

8340-7/5954-8345—Noise Figure Measurements with 8340B & 8341B

8349-1/5954-1516—Achieving Calibrated Output Power with the HP 8350 Sweep Oscillator/8349 Broadband Amplifier Combination

8350-2/5952-9330—Improved Frequency Accuracy

8350-4/5954-1505—Pulse Modulation Characteristics of the HP 83500 Series Sweep Oscillator RF Plug-ins

- 8350-6/**5952-8089**—Reducing Harmonics Using Integra TMF-1800H
- 8350-8/**5954-1507**—Leveling the HP 8350B Sweep Oscillator with an HP 430 Series Power Meter
- 8350-9/**5954-8344**—Improving Output Flatness
- 8360-1/**5952-8089**—HP 8340/41 to HP 8360 System Conversion Guide
- 8360-2/**5952-8090**—Obtaining flat test port power with the HP 8360 User Flatness Correction Feature
- 8508-3/**5952-3522**—Automatic Group Delay
- 8510-12/**5956-4331**—Millimeter-wave Measurements Using the HP 8510B Network Analyzer
- 8510-13/**5956-4373**—Measuring Noninsertable Devices
- 8510-14/**5952-6674**—Using Multiple Test Sets with the HP 8510B
- 8510-2/**5954-1522**—Radar Cross-Section Measurements with the HP 8510 Network Analyzer
- 8510-3/**5954-1535**—Measuring Dielectric Constant with the HP 8510 Network Analyzer
- 8510-5A/**5956-4352**—Specifying Calibration Standards
- 8510-6/**5954-1579**—On-Wafer Measurements Using Cascade Prober
- 8510-7/**5954-8379**—Measuring Frequency Translation Devices
- 8510-8/**5954-8382**—Applying TRL Cal to Non-coaxial measurements
- 8642A/B-1/**5953-8453**—The Benefits and Use of the HP 8642A/B
- 8642A/B-2/**5953-8452**—Using Sweep Functions on the HP 8642A/B
- 8644A/**5951-6727**—Series 200/300 HP-SL Programming Guide
- 8645-1/**5951-6711**—Agile Operation of the HP 8645A
- 8645-2/**5951-6712**—A Catalog of HP 8645A Information
- 8665A/**5951-6727**—Series 200/300 HP-SL Programming Guide
- 8673H-1/**5952-1470**—Improved Frequency Accuracy in Scalar Analysis Using the HP 8673H with Synthesized Sweep
- 8683/4-1/**5952-8260**—Applications and Performance of the 8683A/B and 8684A/B Microwave Signal Generators
- 8753-1/**5956-4361**—Amplifier Measurements Using the HP 8753 Network Analyzer
- 8753-2/**5956-4362**—Mixer Measurements Using the HP 8753B Network Analyzer
- 8756-2/**5954-1506**—Using the HP 11664C Detector Adapter to Make Millimeter-wave Scalar Measurements
- 8756-4/**5953-8894**—How to Automate the HP 5344S Source Synchronizer, the HP 8350B Sweep Oscillator, and the HP 8756 Scalar Analyzer with an HP Series 200 Computer
- 8756A-1/**5953-8869**—Automating the 8756 Scalar Network Analyzer
- 8757-1/**5954-8386**—Using AC Detection with the HP 8756/8757 Scalar Network Analyzers to Make More Accurate Measurements
- 8757-2/**5954-8380**—V and W Band Millimeter Scalar Measurements Using the HP 8757 Scalar Network Analyzer
- 8757-5/**5954-1537**—Measuring Voltage-Controlled Devices
- 8757-6/**5954-8347**—Automated Amplifier Measurements using 8757A
- 8760-1/**5959-7860**—HP 8760 Series Custom Microwave Switch Matrixes
- 8770S-2/**5954-6360**—Effective Use of the HP 8770S Signal Simulator System
- 8780A-1/**5954-6368**—Introductory Operating Guide to the HP 8780A Vector Signal Generator
- 8791-1/**5953-2343**—Using Dynamic Data with HP FASS
- 8791-2/**5953-2345**—Programming HP FASS with WGL
- 8791-3/**5952-1053**—Theory of Operation of the HP FASS
- 8791-4/**5952-0507**—Secure Communications Testing with the HP FASS
- 8791-5/**5952-1901**—Tips on External Clock Operation with the HP FASS
- 8791-6/**5952-1903**—Jamming Signal Capability of the HP FASS
- 8791-7/**5952-1058**—Spectral Purity of the HP FASS
- 8901A-1/**5952-8248**—Extending the Frequency Range of the 8901A Modulation Analyzer
- 8902A-2/**5953-8436**—Accurate Signal Characterization at Millimeter-wave Frequencies
- 8903A-1/**5952-8246**—Operating the 8903A Audio Analyzer Below 20 Hz
- 8904A-1/**5951-6748**—Using the HP 8904A Multifunction Synthesizer as a Communications Signaling Source
- 8904A-2/**5953-8487**—Using the HP 8904A Multifunction Synthesizer as an FM Stereo Composite Generator
- 8904A-3/**5953-8488**—Using the HP 8904A Multifunction Synthesizer as a Modulation Source for Navigation Applications
- 8904A/**5951-6715**—A Book of Ideas for Creating Waveforms with the HP 8904A
- 8970B/S-2/**5954-8896**—Applications and Operation of the HP 8970B Noise Figure Meter and HP 8970S MW Noise Figure Measurement System
- 8970B/S-3/**5952-6639**—Noise Parameter Measurement Using the HP 8970B Noise Figure Meter and the ATN Model NP4 Noise Parameter Test Set
- 8970B/S-4/**5959-8742**—Displaying HP 8970B Noise Figure Meter Measurements on the HP 8757 Scalar Network Analyzer
- 8980A-2/**5952-3704**—Dynamic Range Considerations of the HP 8980A Vector Analyzer
- 11970-71/**5954-9100**—HP 11970-71 Series Harmonic Mixers
- 34800-1/**5953-7028**—Programming and Demo Guide to the HP FTM/300 Functional Test Manager Software Package
- 35651A-1/**5954-7965**—Introduction to Programming the HP 35650 Series Hardware
- 35660A-3/**5952-8069**—Bearing Runout Measurements on Disk Spindles
- 35660A-4/**5952-2145**—Controlling an HP-IB with the HP 35660A
- 44458A/**5953-7022**—Using HP DACQ/300 Programming Guide
- 54110 A/D/**5954-2644**—Precision Time-Interval Measurements with the HP 54100/110 Digitizing Oscilloscope
- 54110D/**5954-2643**—Dual Delayed Sweep Versus Random Repetitive Sampling
- 54120-1/**5954-2693**—Histograms and Statistical Analysis of Signals for Use with the HP 54120T Digitizing Oscilloscope
- 54201A/D/**5954-2642**—Solving Measurement Problems in the Communications Industry
- 70000-1/**5954-9135**—HP 70000 System Design Overview
- 83040-1/**5952-1906**—Using the HP 83040 Series Modular Microcircuit Package: Assembly Instructions
- 83040-2/**5952-1907**—Calibration and Modeling Using the HP 83040 Modular Microcircuit Package
- 94000/**5952-1434**—HP 94000 Software Products

# FREE PUBLICATIONS

## Aids to Selecting, Using & Maintaining HP Products



### Free guides for selecting, using and maintaining HP products

Hewlett-Packard offers a variety of free publications to help you choose the products that best fill your needs, to help you benefit from applications knowledge acquired by users inside and outside of Hewlett-Packard, and to help you maintain your HP products. These publications range from new-product announcements, catalogs, product family brochures, and single-product technical data through application notes, product notes, and programming aids to service notes and general maintenance periodicals. The number and types of free publications vary with product family. A summary of available publications is provided here. Brief descriptions of some publications follow the summary.

### Instruments and Systems

#### Product information

Test & Measurement News  
Data sheets, brochures, and video tapes  
Catalogs

HP DIRECT Instruments Now Catalog  
(5954-0193)

DC Power Supply Catalog with Electronic Loads (5952-4203)

RF, Microwave, & Millimeter Wave Measurement Catalog (5953-2346)

HP DesignCenter magazine

HP Journal

#### Application information

Application Note Index (5954-0203)

Application Notes

Product Notes

Programming Notes

#### Service information

Service Notes

Bench Briefs

### Computers, Peripherals & Calculators

#### Product information

Test & Measurement News

Data sheets & brochures

Selection guides

Catalogs

Computer Users Catalog (5953-2450)

HP Technical Software Catalog

(5952-6696)

Software Solutions Catalog for HP-UX

Operating Systems (5952-7010)

Solutions Catalog for MPE, MPE-XL

Operating Systems (5952-7013)

Your Guide to Pen Plotter, Color Graphics

Printer, and Electrostatic Plotter

Supplies (5952-0649, 5952-0650)

HP Journal

#### Application Information

Application Note Index (5954-0203)

Application Notes

Application Briefs

Plotter Notes

Set-Up Instructions (for plotters)

### Components

#### Product information

Catalogs

Coaxial Components Catalog (5959-7861)

Microwave and RF Designer's Catalog

(5954-2238)

Optoelectronics Designer's Catalog

(5952-2481)

Data sheets

HP Journal

Component Update

#### Application information

Application Note Index (5954-0203)

Application Notes

Application Bulletins

### Periodicals

#### Test & Measurement News

Six times a year *Test & Measurement News* announces the latest HP electronic measuring instruments and accessories; computer/controller, component, and telecom products; and new product literature such as data sheets, application notes, and catalogs.

#### HP DesignCenter

*HP DesignCenter* is published for users of HP systems for electronic design, printed circuit board layout, microprocessor-based development, mechanical design, and software engineering. This full-color magazine features information on new value-added business partners, customer application stories, answers to common customer questions, and announcements of new product enhancements.

#### Hewlett-Packard Journal

The *Hewlett-Packard Journal* is published six times a year to communicate technical information from the laboratories of Hewlett-Packard to all of the fields served by HP. It contains in-depth design descriptions of current hardware and software products, research papers, and more general information such as advances in technology.

### Application Information

#### Application Note Index

The *Application Note Index* lists and describes the contents of all Application Notes, Programming Notes, and Product Notes on electronic instruments, instrument systems, and solid-state components.

#### Application Notes, Briefs, & Bulletins

These aids to solving your measurement, computation, and design problems offer the benefit of the applications research and experience of both HP customers and HP engineers. Some are tutorial, others describe how-to procedures. All of the publications are oriented to multiple products.

#### Product Notes

Product Notes are product-specific aids that supplement the operating and service manuals supplied with HP instruments. They cover applications of the specific instrument. They include analysis of specifications and characteristics with the goal of obtaining improved performance over limited operating conditions and narrower environmental limits.

#### Programming Notes

Programming Notes provide product-specific information on the use and operation of instruments in HP-IB systems. Some notes address the needs of inexperienced users and cover basic operation of an HP-IB instrument using a specific HP desktop computer. Others address the needs of experienced users.

### Service Information

#### Service Notes

Service Notes contain product-specific service information for HP electronic products. Subjects include product improvements, modifications, and procedures for troubleshooting, maintenance, and repair. Service Notes are published as appropriate throughout the life of a product. All new instrument-related Service Notes are announced in *Bench Briefs*.

#### Bench Briefs

*Bench Briefs* provides timely application information for those who repair and calibrate HP instruments. Subjects include troubleshooting tips and descriptions of new technologies, components, tools, and equipment. Also, new instrument-related Service Notes are listed in *Bench Briefs* as they become available.

### How to Obtain Free Publications

To obtain any of the publications described on this page, contact your nearest HP office. Locations of HP offices are listed on the back pages of this catalog.

When requesting any of the catalogs listed on this page, please include the number in parentheses following the catalog's title.



---

# 1991

